



Giga Test Labs

POST OFFICE BOX 1927 CUPERTINO, CA

TELEPHONE (408) 524-2700 FAX (408) 524-2777

Emulation Technology

**SCREW LOCK BGA SOCKET
0.80MM PITCH - SMT STYLE
BPW-100-6BG010-30**

Final Report

**Electrical Characterization
0.05-3.05 GHz**

November 7, 2002

Table of Contents

| Subject | page |
|--|-------------|
| Table of Contents..... | 2 |
| Summary..... | 3 |
| Objective | 3 |
| Methodology: | 3 |
| Figure 1: Surrogate Package..... | 3 |
| Figure 2 – Socket Fixture..... | 4 |
| Figure 3 – Signal pin load conditions | 5 |
| Measurement system | 5 |
| Equivalent-circuit model..... | 6 |
| Figure 4 - 0.8MM BGA socket equivalent-circuit diagram | 6 |
| Element definitions | 6 |
| Element values | 6 |
| Table 1 – 0.8MM BGA socket element values | 7 |
| Conclusions | 7 |
| Figure 5 - Bandwidth measurement..... | 7 |
| Appendix..... | 8 |

Summary

Objective

The ET 0.8MM BGA socket was measured at GigaTest Labs to assess its electrical performance. Also, its high-speed performance limits were determined.

Methodology:

A custom fixture was first designed by GTL which allows the use of coplanar probes to make the measurements. A second fixture was fabricated to be placed inside each socket. It provides connections between the internal pins, so pairs of pins can be measured in different load conditions. This fixture is referred to as "surrogate package". Figure 1 shows a picture the surrogate package, while figure 2 shows the top and bottom side of the fixture.

Figure 1: Surrogate Package

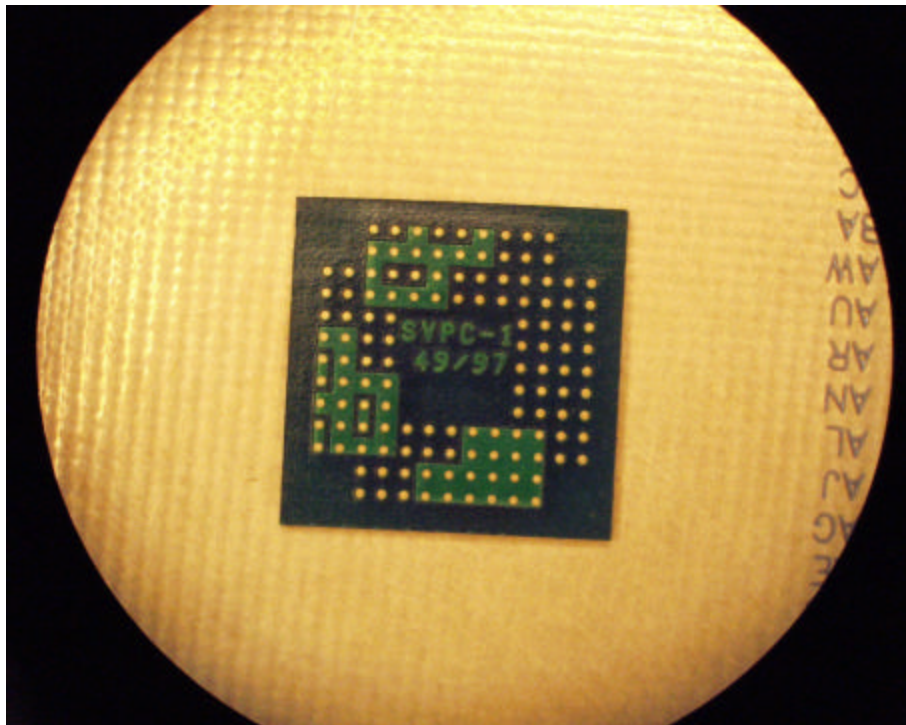
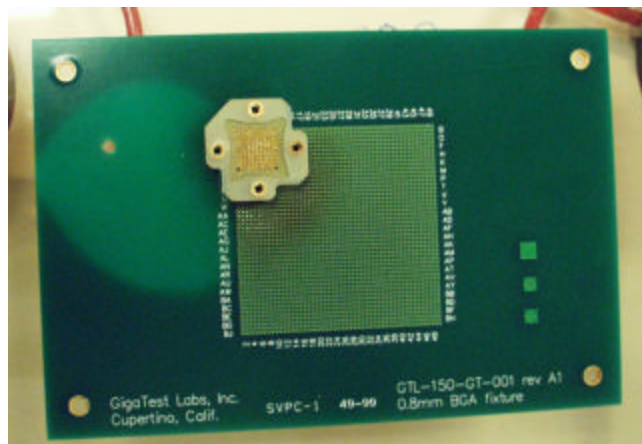
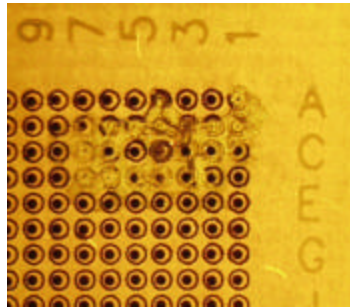

Figure 2 – Socket Fixture



There are three load conditions used on the signal pins: the **open** measurement is performed on two pins with just unconnected surface pads on the surrogate package. The **short** measurement is done with the pins shorted to the ground on the surrogate. The **thru** is just the two pins connected together. These are illustrated on figure 3. The measured pins are denoted by the numbers 1 & 2. The adjacent pins to the measurement, usually the three nearest neighbors are grounded to the fixture ground and the surrogate package ground.

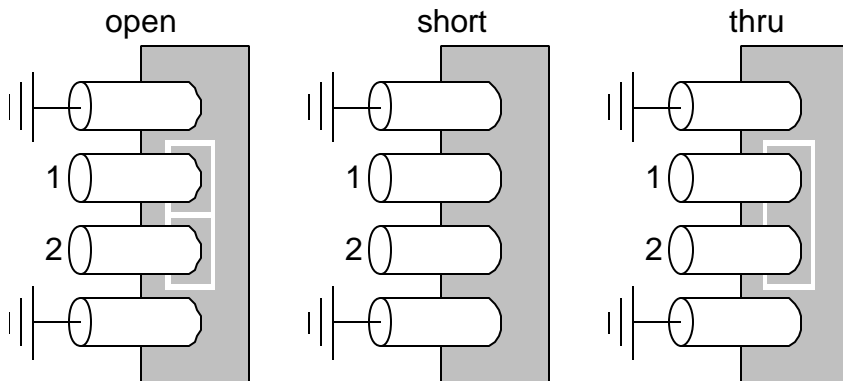

Figure 3 – Signal pin load conditions

The fixture was measured separately to extract its parasitics, so they could later be de-embedded from the overall measurement.

The Hewlett-Packard 8510C network-analyzer was used to measure two-port s-parameters. The frequency range was 0.05 – 20.05 GHz. From the s-parameter data, a SPICE-compatible equivalent circuit was derived using Agilent ADS version 2001

Measurement system

All measurements were taken using a high-frequency measurement system. This consists of a Hewlett-Packard 8510C network analyzer & GGB Picoprobes™ 450 μm pitch. The HP 8510C network analyzer is a frequency domain instrument. The measurements are taken as scattering parameters (a.k.a. s-parameters). The HP8510C has great calibration capabilities, which make it the most accurate high-frequency instrument available. For this work the short-open-load-thru (SOLT) calibration was used. The GGB Picoprobes provide a high-quality 50 Ω path from the network analyzer and cables to the DUT.

Equivalent-circuit model

Figure 4 shows the topology used to model the multi-site contactor (0.80mm pitch). Please note that only two pins are shown in this schematic, however there will be similar mutual elements (M_{21} , C_{21A} and C_{21B}) to **ALL the surrounding pins**.

Therefore, to implement the model for one pin, the user needs to describe it and all the pins surrounding it (a total of 9 pins). By the same reasoning, to implement two pins, then the models for 12 pins will be needed

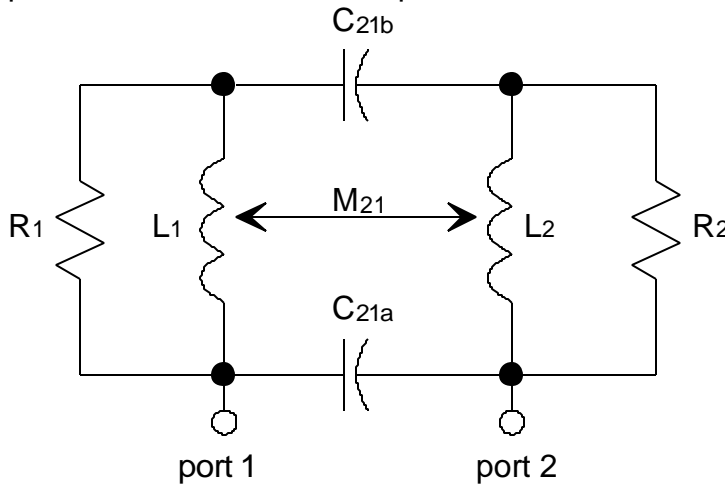

Figure 4 – 0.80MM BGA socket equivalent-circuit diagram

Element definitions

- L_1, L_2 : pin self-inductance
- M_{21} : mutual inductance between adjacent pins
- R_1, R_2 : shunt-resistance of inductors L_1 and L_2 , used to model high-frequency loss due to skin effect and dielectric loss
- C_{21a} : mutual-capacitance between adjacent pins (PCB side)
- C_{21b} : mutual-capacitance between adjacent pins (0.8mm BGA side)

Element values

The 0.8MM BGA socket model is valid from DC to 3.05 GHz. The measured and modeled transmission response agrees within 0.6 dB. Models were extracted for four types of pins: adjacent field pins, edge pins, corner pins and diagonal pins.

Table 1 – 0.8MM BGA socket element values

| pins | L_1 & L_2 (nH) | M_{21} (nH) | R_1 & R_2 (W) | C_{21a} (pF) | C_{21b} (pF) |
|-----------------|-----------------------|------------------|----------------------|-------------------|-------------------|
| field adjacent | 1.69 | 0.14 | 300 | 0.050 | 0.050 |
| field edge | 1.80 | 0.18 | 400 | 0.083 | 0.083 |
| corner adjacent | 1.85 | 0.19 | 400 | 0.083 | 0.083 |

Conclusions

1. The bandwidth for the 0.8MM BGA socket was determined from a loop-thru measurement on two adjacent pins. The nearest row of pins was grounded (see figure 5). The 1-dB bandwidth was 3.45 GHz, please see page 12 of the Appendix.

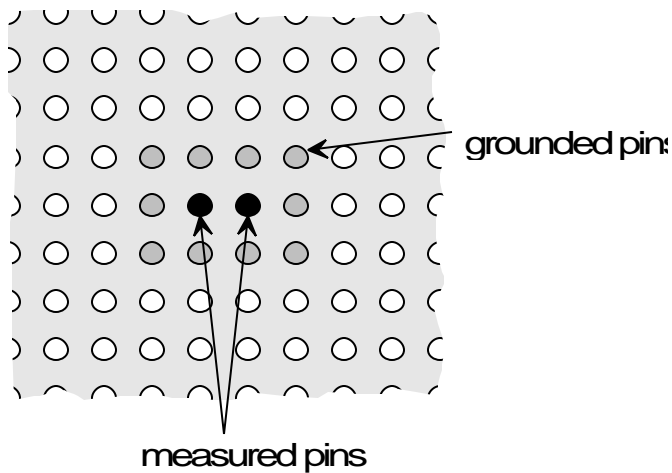

Figure 5 - Bandwidth measurement

2. The model bandwidth is DC-3.05 GHz, which will easily handle signals with 300 ps edges.
3. The contact resistance (R_s) on the socket is 0.07 ohms.

Appendix

The appendix shows the measured and simulated output data.

| Measured and simulated data | page |
|--|-------------|
| Open measurement on adjacent pins | 9 |
| Shorted measurement on adjacent pins | 10 |
| Loop-thru measurement on adjacent pins | 11 |
| Loop-thru bandwidth measurement (10 GHz) | 12 |

Adjacent pins open

Measured s-parameters in blue, simulated s-parameters in red

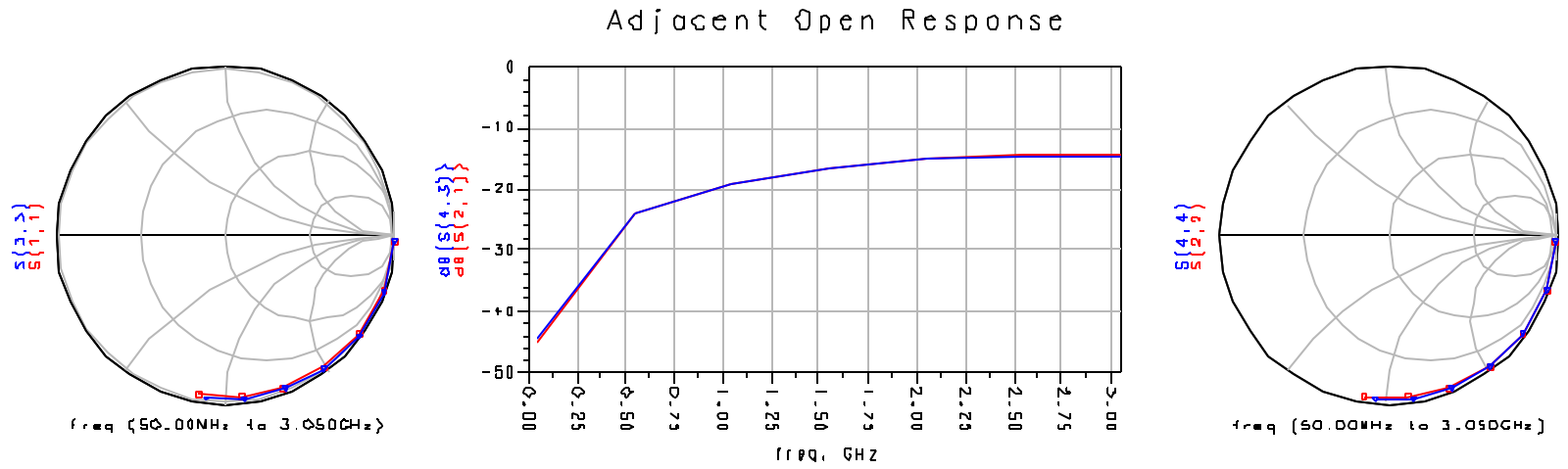

Adjacent pins shorted to ground

Measured s-parameters in blue, simulated s-parameters in red

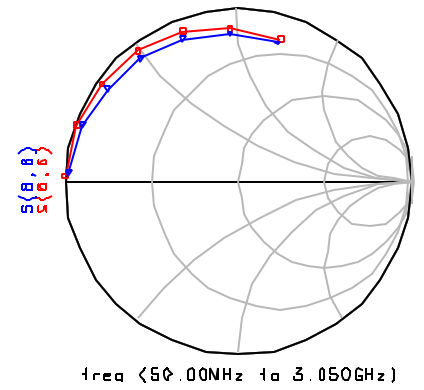
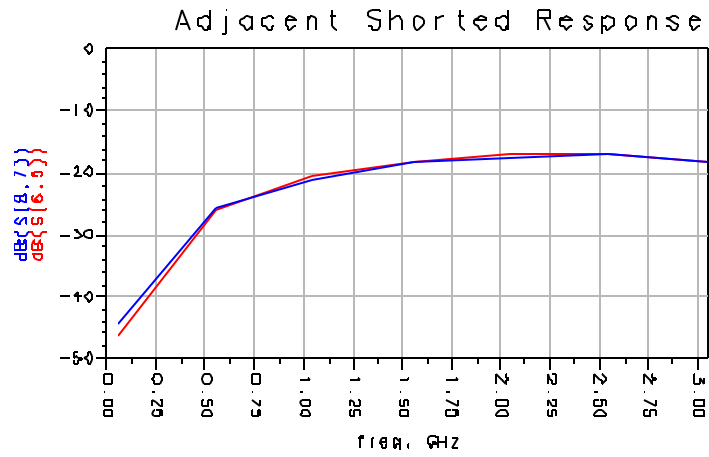
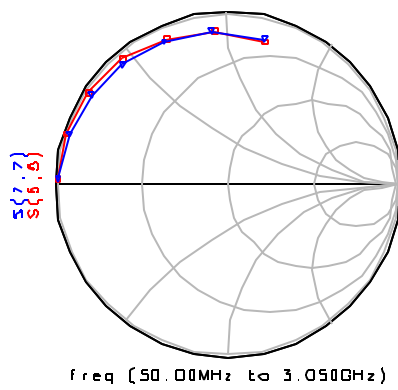

Adjacent pins connected together (loop-thru)

Measured s-parameters in blue, simulated s-parameters in red

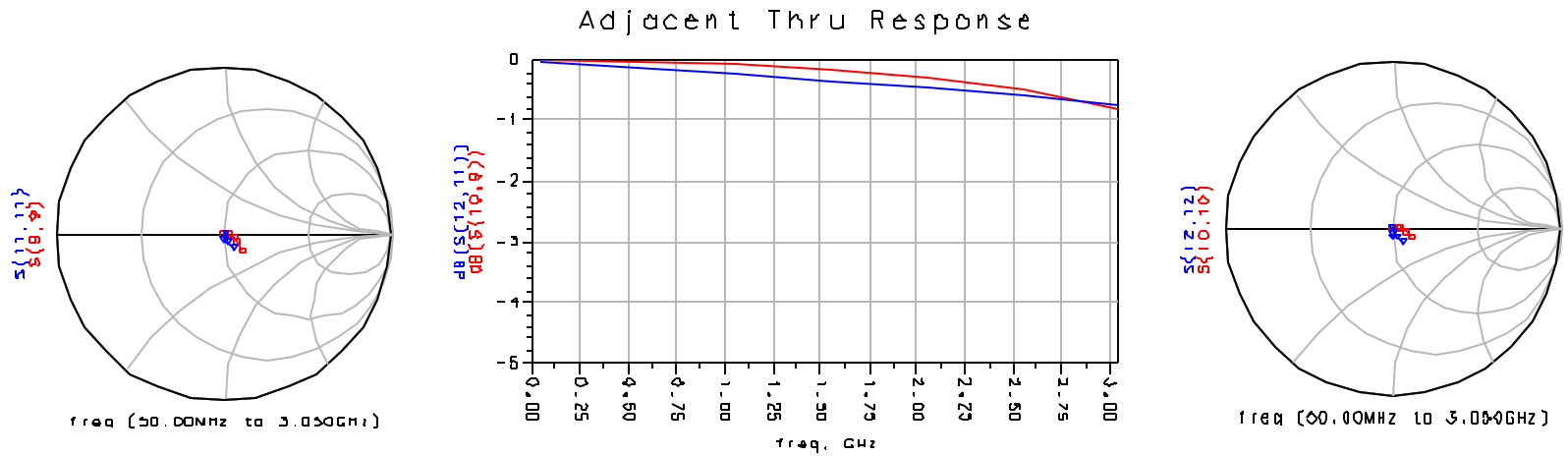

Loop-thru Bandwidth Measurement

Measure insertion loss versus frequency for two pins in series

