

HOW TO ORDER

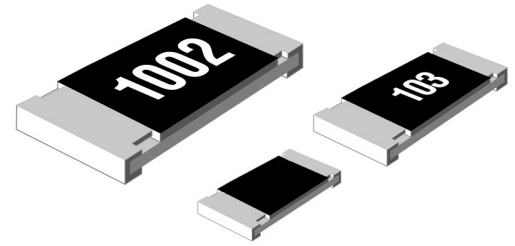
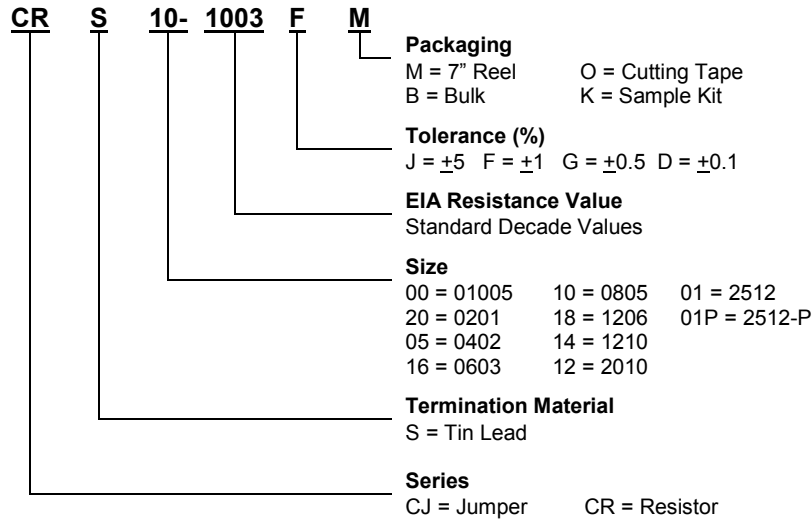

FEATURES

- Small size to 01005
- Operating temperature -55°C ~ +125°C
- High Reliable Termination

SCHEMATIC

Wrap Around Terminal
CRT, CJT, CRPT, CJPT type

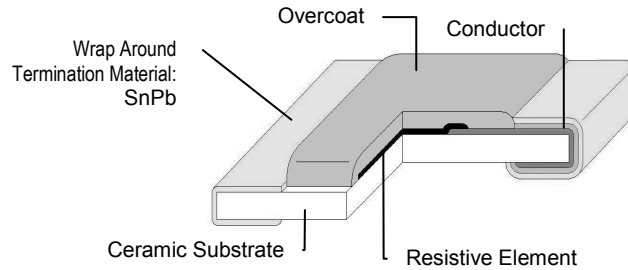
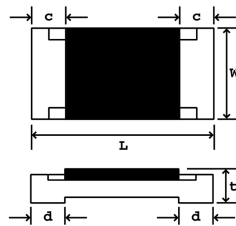

DIMENSIONS (mm)

Size	Size Code	L	W	c	d	t
01005	00	0.40 ± 0.03	0.20 ± 0.03	0.10 ± 0.05	0.10 ± 0.05	0.13 ± 0.05
0201	20	0.60 ± 0.03	0.30 ± 0.03	0.10 ± 0.05	0.15 ± 0.05	0.23 ± 0.03
0402	05	1.00 +0.1-0.05	0.50 ± 0.05	0.20 ± 0.10	0.25 ± 0.10	0.35 ± 0.05
0603	16	1.60 ± 0.10	0.80 ± 0.10	0.30 ± 0.20	0.30+0.20-0.10	0.45 ± 0.10
0805	10	2.00 ± 0.10	1.25 ± 0.10	0.40 ± 0.20	0.40 ± 0.20	0.50 ± 0.10
1206	18	3.10 ± 0.10	1.55 ± 0.10	0.50 ± 0.30	0.40 ± 0.20	0.55 ± 0.10
1210	14	3.10 ± 0.10	2.55 ± 0.10	0.50 ± 0.30	0.40 ± 0.20	0.60 ± 0.10
2010	12	5.00 ± 0.15	2.50 ± 0.15	0.60 ± 0.30	0.50 ± 0.25	0.60 ± 0.10
2512	01	6.30 ± 0.20	3.20 ± 0.20	0.60 ± 0.30	0.50 ± 0.25	0.60 ± 0.10
2512-P	01P	6.30 ± 0.20	3.20 ± 0.20	0.60 ± 0.30	0.50 ± 0.25	0.60 ± 0.10

ELECTRICAL SPECIFICATIONS for CHIP RESISTORS

Size	01005	0201	0402	0603	0805
Power Rating (EIA 575)	1/32W	1/20W	1/16W	1/10W	1/8W
Max. Working Voltage*	15V	25V	50V	50V	150V
Max. Overload Voltage	30V	50V	100V	100V	300V
Operating Temp.	70°C	70°C	70°C	70°C	70°C

Size	1206	1210	2010	2512
Power Rating (EIA 575)	1/4W	1/3W	1/2W	1W
Max. Working Voltage*	200V	200V	200V	200V
Max. Overload Voltage	400V	400V	400V	400V
Operating Temp.	70°C	70°C	70°C	70°C



Thick Film Chip Resistors Tin Lead Termination

Size	TCR (ppm/°C)	Tolerance (%) and Resistance			
		D(±0.1%) & E-96 & E-24	G(±0.5%) & E-96 & E-24	F(±1%) & E-96 & E-24	J(±5%) & E-24
01005	± 300			10Ω≤R<100Ω	10Ω≤R<100Ω
	± 200			100Ω≤R<1MΩ	100Ω≤R<1MΩ
0201	±200		100Ω-10KΩ	10Ω-2MΩ	10Ω-10MΩ
	+600 -200			1Ω-9.1Ω	1Ω-9.1Ω
0402	±100	100Ω-499KΩ	100Ω-1MΩ	100Ω-1MΩ	
	±200	10Ω-100Ω	10Ω-100Ω	10Ω≤R<100Ω 1MΩ<R≤10MΩ	10Ω-10MΩ
	+500 -200			1Ω-9.1Ω	1Ω-9.1Ω
	±400				10MΩ≤R≤20MΩ
0603	±100	10Ω-560kΩ	10Ω-1MΩ	10Ω-1MΩ	
	±200			1M<R≤10MΩ	10Ω-10MΩ
	±400			1Ω-9.1Ω	1Ω-9.1Ω 10MΩ<R≤20MΩ
0805	±100	10Ω-560kΩ	10Ω-1MΩ	10Ω-1MΩ	
	±200			1M<R≤10MΩ	10Ω-10MΩ
	±400			1Ω-9.1Ω	1Ω-9.1Ω 10MΩ<R≤20MΩ
1206	±100	10Ω-560kΩ	10Ω-1MΩ	10Ω-1MΩ	
	±200			1M<R≤10MΩ	10Ω-10MΩ
	±400			1Ω-9.1Ω	1Ω-9.1Ω 10MΩ<R≤20MΩ
1210	±100	10Ω-560kΩ	10Ω-1MΩ	10Ω-1MΩ	
	±200			1M<R≤10MΩ	10Ω-10MΩ
	±400			1Ω-9.1Ω	1Ω-9.1Ω 10MΩ<R≤20MΩ
2010	±100	10Ω-560kΩ	10Ω-1MΩ	10Ω-1MΩ	
	±200			1M<R≤10MΩ	10Ω-10MΩ
	±400			1Ω-9.1Ω	1Ω-9.1Ω 10MΩ<R≤20MΩ
2512	±100	10Ω-560kΩ	10Ω-1MΩ	10Ω-1MΩ	
	±200			1M<R≤10MΩ	10Ω-10MΩ
	±400			1Ω-9.1Ω	1Ω-9.1Ω 10MΩ<R≤20MΩ

* Rated Voltage: $\sqrt{P \times R}$

ELECTRICAL SPECIFICATIONS for ZERO OHM JUMPERS

Series	CJS20 (0201)	CJS05 (0402)	CJS06 (0603)	CJS10 (0805)	CJS18 (1206)	CJS14 (1210)	CJS12 (2010)	CJS01 (2512)
Rated Current	0.5A (70°C)	1A (70°C)	1A (70°C)	2A (70°C)	2A (70°C)	2A (70°C)	2A (70°C)	2A (70°C)
Resistance (Max)	50 m Ω	50 m Ω	50 m Ω	50 m Ω	50 m Ω	50 m Ω	50 m Ω	50 m Ω
Max. Overload Current	1A	2.5A	2.5A	5A	5A	5A	5A	5A
Working Temp.	-55°C ~ +125°C	-55°C ~ +125°C	-55°C ~ +125°C	-55°C ~ +125°C	-55°C ~ +125°C	-55°C ~ +125°C	-55°C ~ +125°C	-55°C ~ +125°C

* Rated Voltage: $\sqrt{P \times R}$

DERATING CURVE

For resistors operated at ambient temperature over 70°, power rating shall be derated in accordance with figure 1.

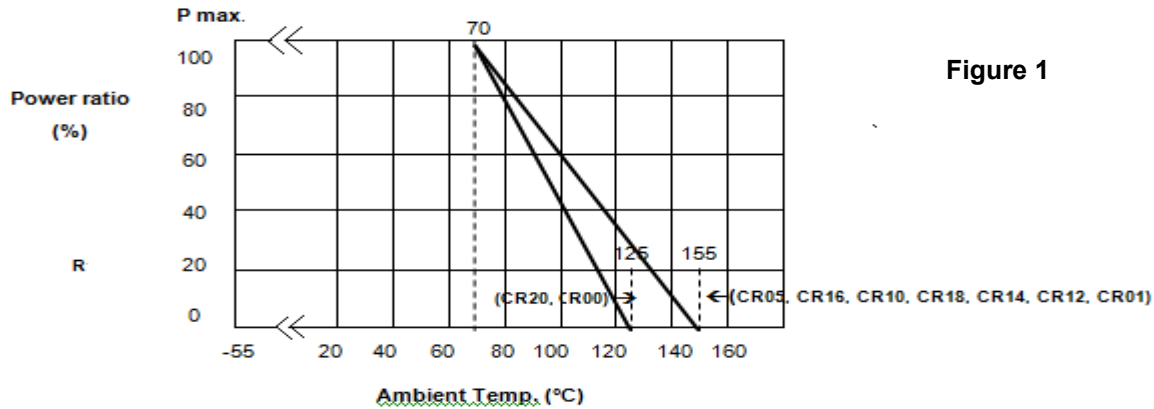

Figure 1

The rated voltage is calculated by the following formula: $E = \sqrt{P \cdot R}$
 $E = \text{Rated Voltage (V)}$, $P = \text{Rated Power (W)}$, $R = \text{Resistance Value } (\Omega)$

RELIABILITY TESTS

Test Items	Reference standard	Condition of Test	Test Limits ΔR
Temperature Coefficient of Resistance	IEC60115-1-4.8 JIS-C5201-1-4.8	-55~+125 °C	Refer 5.0
Short Time Overload	IEC60115-1-4.13 JIS-C5201-1-4.13	2.5 X rate voltage for 5 sec	$\pm(1\% + 0.05\Omega)$ Remarks: 0201 : $\pm(3\% + 0.1\Omega)$ 0402 : $\pm(2\% + 0.1\Omega)$ 0Ω : 50mΩ or less
Intermittent Overload	IEC60115-1-4.39 JIS-C5201-1-4.39	3.0 X rated voltage or Max Overloading voltage, 1sec "ON", 25sec "OFF", 10000 cycles Remarks: 0201-NA, 0402 2.5 X RCWV*)	$\pm(5.0\% + 0.1\Omega)$ 0Ω : 50mΩ or less
Endurance (Load Life)	IEC60115-1-4.25.1 JIS-C5201-1-4.25.1	1000 hours at rated voltage, 70°C, 1.5hours "ON", 0.5hour "OFF"	0.1%, 0.5%, 1% : $\pm(1.0\% + 0.05\Omega)$ 2%, 5% : $\pm(3.0\% + 0.1\Omega)$ Remarks: 0201 : $\pm(5\% + 0.1\Omega)$ 0402 : $\pm(3\% + 0.1\Omega)$ 0Ω : 100mΩ or less
Load Life with Humidity	IEC60115-1-4.24 JIS-C5201-1-4.24	1000 hours at rated voltage, 40±2°C, 90~95% RH 1.5hours "ON", 0.5hour "OFF"	0.1%, 0.5%, 1% : $\pm(1.0\% + 0.05\Omega)$ 2%, 5% : $\pm(3.0\% + 0.1\Omega)$ Remarks: 0201 : $\pm(5.0\% + 0.1\Omega)$ 0402 : $\pm(3.0\% + 0.1\Omega)$ 0Ω : 100mΩ or less
Rapid Change of Temperature	IEC60115-1-4.19 JIS-C5201-1-4.19	-55°C (30 min.) / +155°C (30 min.) 5 cycles	0.1%, 0.5%, 1% : $\pm(0.5\% + 0.05\Omega)$ 2%, 5% : $\pm(1.0\% + 0.05\Omega)$ Remarks: 0201 : $\pm(3\% + 0.1\Omega)$ 0Ω : 50mΩ or less
Solderability	IEC60115-1-4.17 JIS-C5201-1-4.17	245±5°C solder, 2±0.5 sec dwell. Solder: Sn96.5 / Ag3.0 / Cu0.5	At least 95% of surface area of electrode shall be covered with new solder
Robustness of Termination (Bending)	IEC60115-1-4.33 JIS-C5201-1-4.33	3mm deflection 2mm deflection (RM20,25)	0.1%, 0.5%, 1% : $\pm(0.5\% + 0.05\Omega)$ 2%, 5% : $\pm(1.0\% + 0.05\Omega)$ Remarks: 0201 : $\pm(1.0\% + 0.1\Omega)$ 0Ω : 50mΩ or less
Dielectric Withstanding Voltage (Voltage Proof)	IEC60115-1-4.7 JIS-C5201-1-4.7	Applying voltage: 0201: 50V, 0402 & 0603: 300V The other 500V for a minute	No abnormalities such as flashover, burning dielectric breakdown shall appear
Insulation Resistance	IEC60115-1-4.6 JIS-C5201-1-4.6	Applying voltage 100V for 1 minute. Remark: 0201 50V	$\geq 1G\Omega$
Resistance to Dry Heat	IEC60115-1-4.23.2 JIS-C5201-1-4.23.2	155±5°C for 96±4hours Remark: 0201 125±5°C	0.1%, 0.5%, 1% : $\pm(1.0\% + 0.05\Omega)$ 2%, 5% : $\pm(2.0\% + 0.1\Omega)$ Remarks: 0201 : $\pm(2.0\% + 0.1\Omega)$ 0Ω : 50mΩ or less
Resistance to Solder Heat	IEC60115-1-4.18 JIS-C5201-1-4.18	270±5°C solder, 10±1 sec dwell.	0.1%, 0.5%, 1% : $\pm(0.5\% + 0.05\Omega)$ 2%, 5% : $\pm(1.0\% + 0.05\Omega)$ Remarks: 0201 : $\pm(3.0\% + 0.1\Omega)$ 0Ω : 50mΩ or less

Note: RCWV: Rated continuous working voltage

EIA Standard Values

Decade Values in the EIA Standard E-24 Series:

1.0	1.1	1.2	1.3	1.5	1.6
1.8	2.0	2.2	2.4	2.7	3.0
3.3	3.6	3.9	4.3	4.7	5.1
5.6	6.2	6.8	7.5	8.2	9.1

Decade Values in the EIA Standard E-96 Series:

1.00	2.10	4.22	8.25	16.9	32.4	59.0
1.02	2.15	4.32	8.45	17.4	33.0	60.4
1.05	2.20	4.42	8.56	17.8	33.2	61.9
1.07	2.21	4.53	8.87	18.0	34.0	62.0
1.10	2.26	4.64	9.09	18.2	34.8	63.4
1.13	2.32	4.70	9.31	18.7	35.7	64.9
1.15	2.37	4.75	9.53	19.1	36.0	65.5
1.18	2.43	4.87	9.76	19.6	36.5	68.0
1.21	2.49	4.99	10.0	20.0	37.4	68.1
1.24	2.56	5.11	10.2	20.5	38.3	69.8
1.27	2.61	5.23	10.5	21.0	39.0	71.5
1.30	2.67	5.36	10.7	21.5	39.2	73.2
1.33	2.74	5.49	11.0	22.0	40.2	75.0
1.37	2.80	5.60	11.3	22.1	41.2	76.8
1.40	2.87	5.62	11.5	22.6	42.2	78.7
1.43	2.94	5.76	11.8	23.2	43.0	80.6
1.47	3.00	5.90	12.0	23.7	43.2	82.0
1.50	3.01	6.04	12.1	24.0	44.2	82.5
1.54	3.09	6.19	12.4	24.3	45.3	84.5
1.58	3.16	6.20	12.7	24.9	46.4	86.6
1.62	3.24	6.34	13.0	25.5	47.0	88.7
1.65	3.32	6.49	13.3	26.1	47.5	90.9
1.69	3.40	6.65	13.7	26.7	48.7	91.0
1.74	3.48	6.80	14.0	27.0	49.9	93.1
1.78	3.57	6.81	14.3	27.4	51.0	95.3
1.80	3.65	6.98	14.7	28.0	51.1	97.6
1.82	3.74	7.15	15.0	28.7	52.3	
1.87	3.83	7.35	15.4	29.4	53.6	
1.91	3.90	7.50	15.8	30.0	54.9	
1.96	3.92	7.68	16.0	30.1	56.0	
2.00	4.02	7.87	16.2	30.9	56.2	
2.05	4.12	8.06	16.5	31.6	57.6	

Those items in a shaded box are also E-24 values and will be marked with the EIA 3 Digit Code.

VALUE MARKING

For those parts ordered with an E-24 value, the product will be marked with a 3 digit code. For those products ordered with an E-96 value, the product will be marked with a 4 digit code. For those parts which fall under E-96 and E-24 values (e.g. 1K ohm is both an E-96 and E-24 value), the part will be marked with a 3 digit code; 4 digit markings for this type is available upon special request.



01005, 0201, and 0402 Size
No marking
E-24 & E-96 Values



0603 Size
EIA 96 Digit Code of 3.32K ohm
E-96 Values



0603, 0805, 1206, 1210, 2010, 2512 Sizes
EIA 3 Digit Code of 10K ohm resistor
E-24 Values, E-96 Values



0805, 1206, 1210, 2010, 2512 Sizes
EIA 4 Digit Code of 121K ohm resistor
E-96 Values

0603 MARKING CODE for E96 VALUES

By combining a specific two digit number and a letter code, you have a series of numeric/alpha digits that give you the complete (E96) resistance value codes for 0603 size part marking.

Value	Code	Value	Code	Value	Code	Value	Code
10.0	01	17.8	25	31.6	49	56.2	73
10.2	02	18.2	26	32.4	50	57.6	74
10.5	03	18.7	27	33.2	51	59.0	75
10.7	04	19.1	28	34.0	52	60.4	76
11.0	05	19.6	29	34.8	53	61.9	77
11.3	06	20.0	30	35.7	54	63.4	78
11.5	07	20.5	31	36.5	55	64.9	79
11.8	08	21.0	32	37.4	56	66.5	80
12.1	09	21.5	33	38.3	57	68.1	81
12.4	10	22.1	34	39.2	58	69.8	82
12.7	11	22.6	35	40.2	59	71.5	83
13.0	12	23.3	36	41.2	60	73.2	84
13.3	13	23.7	37	42.2	61	75.0	85
13.7	14	24.3	38	43.2	62	76.8	86
14.0	15	24.9	39	44.2	63	78.7	87
14.3	16	25.5	40	45.3	64	80.6	88
14.7	17	26.1	41	46.4	65	82.5	89
15.0	18	26.7	42	47.5	66	84.5	90
15.4	19	27.4	43	48.7	67	86.6	91
15.8	20	28.0	44	49.9	68	88.7	92
16.2	21	28.7	45	51.1	69	90.9	93
16.5	22	29.4	46	52.3	70	93.1	94
16.9	23	30.1	47	53.6	71	95.3	95
17.4	24	30.9	48	54.9	72	97.6	96

Letter Multiplier Cross Reference

A = 10 C = 1,000 E = 100,000 X = 1
B = 100 D = 10,000 F = 1,000,000 Y = 0.1

0603 Code	Explanation	Value
01B	01 = 10.0 & B = 100	10.0x100 = 1K Ω
25C	25 = 17.8 & C = 1,000	17.8x1,000 = 17.8K Ω
93D	93 = 90.9 & D = 10,000	90.9 x 10,000 = 909K Ω

PACKAGE QUANTITY

Type	01005	0201	0402	0603	0805
B				25,000	10,000
M	15,000	10,000	10,000	5,000	5,000
V		40,000	40,000	20,000	20,000

Type	1206	1210	2010	2512
B	5,000			
M	5,000	5,000	4,000	4,000
V	20,000	20,000	20,000	20,000

TAPE SCHEMATIC

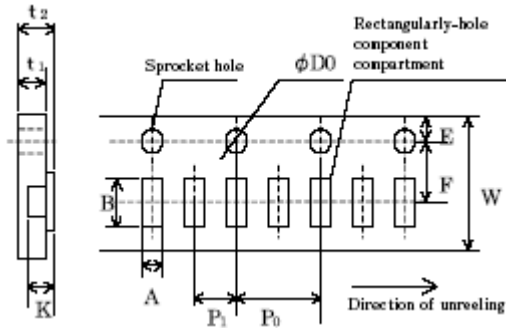

01005 Size

A	B	W	F	E	
0.38±0.02	0.68±0.02	8.0±0.10	3.5±0.05	1.75±0.05	
P1	P0	D0	t1	t2	K
2.0±0.05	4.0±0.10	1.55±0.03	0.42±0.05	0.5	0.27±0.02

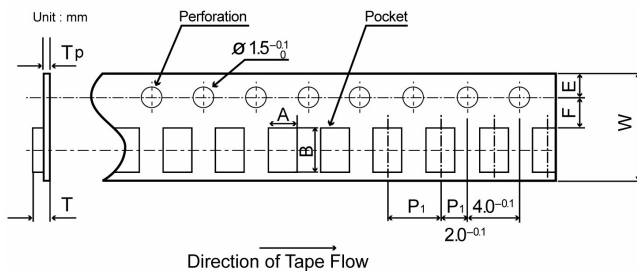

0201 ~ 2512 Size

TAPE DIMENSIONS (mm)

	0201	0402	0603	0805
A	0.37±0.05	0.65±0.1	1.1±0.2	1.65±0.2
B	0.67±0.1	1.15±0.1	1.9±0.2	2.4±0.2
W	8.0±0.2	8.0±0.2	8.0±0.2	8.0±0.2
E	1.75±0.1	1.75±0.10	1.75±0.1	1.75±0.1
F	3.5±0.05	3.5±0.05	3.5±0.05	3.5±0.05
P1	2.0±0.1	2.0±0.05	4.0±0.1	4.0±0.1
T	0.5 _{max}	0.55±0.1	0.70±0.1	0.90±0.1
Tp	0.4±0.05	0.40±0.05	0.60±0.1	0.75±0.1

	1206	1210	2010	2512
A	2.0±0.15	2.9±0.1	2.9±0.1	3.4±0.1
B	3.6±0.15	3.5±0.1	5.3±0.1	6.6±0.1
W	8.0±0.2	8.0±0.2	12.0±0.2	12.0±0.2
E	1.75±0.1	1.75±0.1	1.75±0.1	1.75±0.1

PACKAGE CONSTRUCTION

- 3 Ring Binder Case Holder
- Plastic pages with slip holders for each value
- Each value is individually identified in a slip holder
- Resistors are packaged on paper tape strips

The content may change without notification 7/21/2016.

F	3.5±0.05	3.5±0.05	5.5±0.05	5.5±0.05
P1	4.0±0.1	4.0±0.1	4.0±0.1	4.0±0.1
T	0.90±0.1	0.90±0.1	1.0±0.1	1.0±0.1
Tp	0.75±0.1	0.75±0.1	0.25±0.1	0.25±0.1

TAPE

Type	Resistor Size
Press Pocket Carrier Tape	01005
Rect. Punching Carrier Paper Tape	0201, 0402, 0603, 0805, 1206, 1210
Plastic (Embossed Tape)	2010 & 2512

REEL DRAWINGS

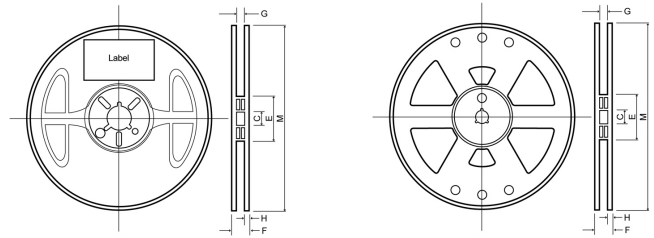

7" Reel (M)

13" Reel (V)

PACKAGE DIMENSIONS (mm)

	7" Reel (M)	13" Reel (V)
M	180 ± 3.0	330±2.5
H	1.20	2.3± 0.5
C	13.0 ± 0.2	13.0 ± 0.2
G	9.0 ± 0.3	9.5 ± 0.5
E	60 ± 1.0	80.0 ± 1.0
F	11.4 ± 1.0	14.4

LABEL DESCRIPTION

One side surface of a reel is marked with a label with the following items of information.

1. Chip Resistor
2. Part Number
3. Tolerance
4. Quantity
5. Lot number for production month/year/suffix L*
6. Manufacturer's name or symbol

* The suffix "L" indicates that this item is lead free. As of September 2004, all new production items of the series CR and CJ are no longer containing tin/lead (SnPb) terminals; they are lead free and in compliance with Lead Free/RoHS.