

PICOSTRAIN

Manual

PSØ81-EVA Evaluation System for PSØ81

15. Dezember 2009
Document-No.: DB_PSØ81-EVA_en VO.1

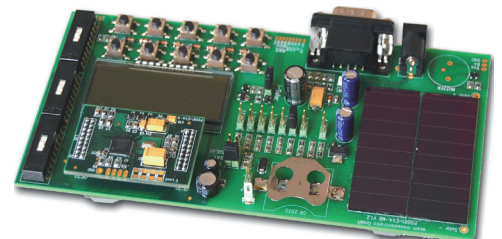

Published by acam-messelectronic gmbh

© **acam-messelectronic gmbh 2009**

Disclaimer / Notes

„Preliminary“ product information describes a product which is not in full production so that full information about the product is not available yet. Therefore, acam messelectronic GmbH („acam“) reserves the right to modify this product without notice. The information provided by this data sheet is believed to be accurate and reliable. However, no responsibility is assumed by acam for its use, nor for any infringements of patents or other rights of third parties that may result from its use. The information is subject to change without notice and is provided „as is“ without warranty of any kind (expressed or implied). Picostrain is a registered trademark of acam. All other brand and product names in this document are trademarks or service marks of their respective owners.

Support

For a complete listing of Direct Sales, Distributor and Sales Representative contacts, visit the acam web site at: <http://www.acam.de/company/distributors> or refer to chapter 8 in this datasheet

For technical support you can contact the acam support team in the headquarter in Germany or the Distributor in your country. The contact details of acam in Germany are:
support@acam.de or by phone +49-7244-74190.

Table of Contents**Page**

1. Introduction	1-1
2. Connecting Strain Gauges	2.1 HR - High Resolution Module 2-2
	2.2 STD - Standard Module 2-6
	2.3 WH - Wheatstone Module 2-6
3. Motherboard	3.1 LCD 3-3
	3.2 External LCD driver 3-4
	3.3 Solar panel 3-4
	3.4 Buzzer 3-4
4. Load Cell	4.1 Technical Specification 4-2
	4.2 Wiring diagram 4-2
5. Evaluation Software	5.1 Installing the Software 5-2
	5.2 Running the Software 5-3
6. Assembler Software	6.1 Installing the Assembler 6-2
	6.2 Running the Assembler 6-3
7. Miscellaneous	7.1 Literature Guide 7-2
	7.2 Contacts / Distributors 7-3
8. Appendix	8.1 Schematic Diagrams 8-2
	8.2 Layout PS081-EVA-HR 8-6
	8.3 Layout PS081-EVA-STD 8-7
	8.4 7.4 Layout PS081-EVA-WH 8-7

acam ®, **PICO**STRAIN ® are registered trademarks of acam-messelectronic gmbh

1	Introduction	1-2
1.1	General.....	1-2
1.2	System Overview	1-2
1.3	Component List	1-2



1 Introduction

1.1 General

The PSØ81-EVA-KIT evaluation system provides a complete weighing system made of a main board with LCD and solar panel, up to three plug-in modules, a 10kg load cell platform and windows-based evaluation and assembler software. It offers extensive and user-friendly configuration and evaluation of the PSØ81 single-chip solution for weigh scales. The PSØ81-EVAL system is connected to the PC's USB interface through the PICOPROG programming device.

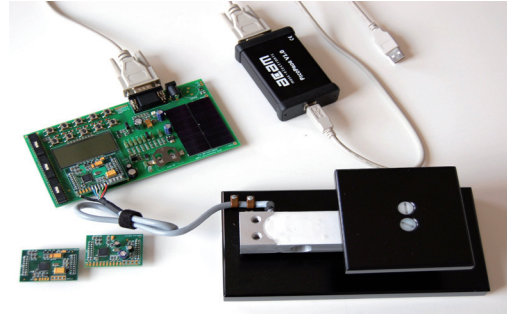

1.2 System Overview

- PSØ81-EVAL-MB main board
 - LCD display 22 x 51 mm²
 - Optional interface to external LCD controller
 - Power select by 3 jumpers:
 - Solar panel 55 x 20 mm²
 - Battery holder for CR2032
 - Wall power supply, Voltage selectable by on-board jumpers
 - 10 Push buttons
 - Serial interface to PICOPROG programmer
 - Optional buzzer
 - PSØ81-EVA-HR high resolution module
 - For up to 150.000 stable scale divisions & solar applications
 - 4 halfbridges
 - 4 layer PCB
- PSØ81-EVA-STD standard module
 - For up to 60.000 stable scale divisions
 - 4 halfbridges
 - 2 layer PCB
 - PSØ81-EVA-WB Wheatstone module
 - For up to 60.000 stable scale divisions with classical load cells
 - 1 Wheatstone bridge
 - 4 layer PCB
 - PICOPROG Programmer
 - 10kg load cell
 - 350 Ohm sensors
 - Mounted on platform
 - Wired as 2 half bridges with 1 span compensation resistor

1.3 Component List

- | | | | |
|-----------------|------------------------------|---------------------|---|
| • PSØ81-EVA-MB | Motherboard | • RS232 cable | Connecting the Evaluation board to the programmer |
| • PSØ81-EVA-HR | High resolution module | • USB cable | Connecting PICOPROG to the PC |
| • PSØ81-EVA-STD | Standard module | • Wall power supply | |
| • PSØ81-EVA-WH | Wheatstone module | • CD-ROM | Incl. software and data sheets |
| • PICOPROG | Programmer | • Buzzer | |
| • Demo scale | 10kg load cell with platform | | |

2	Connecting Strain Gauges	2-2
2.1	HR - High Resolution Module	2-2
2.1.1	Capacitor Selection and Assembly.....	2-2
2.1.2	Gain Compensation Resistors	2-3
2.1.3	Halfbridge	2-3
2.1.4	Fullbridge	2-4
2.1.5	Quattro Mode.....	2-5
2.1.6	Modification for Solar Applications	2-5
2.2	STD - Standard Module	2-6
2.3	WH - Wheatstone Module	2-6
2.3.1	Capacitor Selection and Assembly.....	2-7
2.3.2	Gain Compensation Resistors	2-7
2.3.3	Wheatstone Bridge Connection.....	2-7

2 Connecting Strain Gauges

The evaluation systems comes with the load cell already connected to the high resolution module. In the following we will explain how the user can apply his own load cell. In case of sensors with other than 350 Ohm resistance the discharge capacitor C_{load} has to be adopted. Also the gain compensation resistors R_{G1} and R_{G2} have to be adjusted.

2.1 HR - High Resolution Module

The high resolution module is designed for applications that use the full performance of the PSØ81. It includes the external bipolar comparator circuit. It can be used up to 150,000 stable scale divisions or solar applications. It is possible to measure up to 4 half bridges. It uses the external comparator to get the highest possible resolution. Due to the PICOSTRAIN measurement principle the system does not need a full bridge. Two resistors, in the following called half bridge, are sufficient.

Figure 1 High Resolution Module

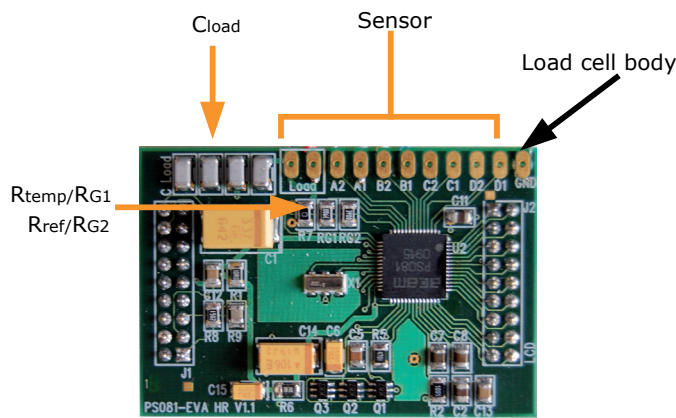

2.1.1 Capacitor Selection and Assembly

The PICOSTRAIN-measurement principle is based on measuring the discharge time of a capacitor. For this reason the correct size and material of the capacitors is significant to achieve best measuring results. In general we recommend a discharging time in the range of

$$\tau = 0.7 * R * C = 80 \text{ to } 120 \mu\text{s}.$$

As material we recommend COG or CFCAP (Multilayer ceramic from Taiyo-Yuden), X7R.

The recommend values are:

$R_{sg} = 350 \text{ Ohm} \rightarrow C_{load} = 300 \text{ nF to } 400 \text{ nF}$

$R_{sg} = 1000 \text{ Ohm} \rightarrow C_{load} = 100 \text{ nF to } 150 \text{ nF}$

The high resolution board is pre-assembled with $C_{load} = 4 \times 100 \text{ nF} = 400 \text{ nF}$.

2.1.2 Gain Compensation Resistors

The two resistors R_{temp} and R_{ref} are needed for two reasons:

- Correction of the delay time of the comparator
- Temperature measurement

The two resistors have to be connected in any case. In case of no temperature measurement both resistors can be of the same type (e.g. carbon resistors).

Temperature measurement is done by measuring the ratio of the discharge times of two resistors, a temperature dependent one and a temperature stable one. The sensitive resistor may be an KTY-type or even cheaper a carbon film resistor. The reference resistor can be a metal film resistor.

Note:

The resistors should have the same value as the strain gauges. The high resolution module is pre-assembled with 350 Ohm resistors.

2.1.3 Halfbridge

A halfbridge is sufficient to run the PS081 evaluation system. The following picture shows a half bridge attached to pads A and B. It is recommended to connect the half bridge like a full bridge. This means A1 & B2 are shorted as well as A2 and B1.

Figure 2 Connecting a halfbridge

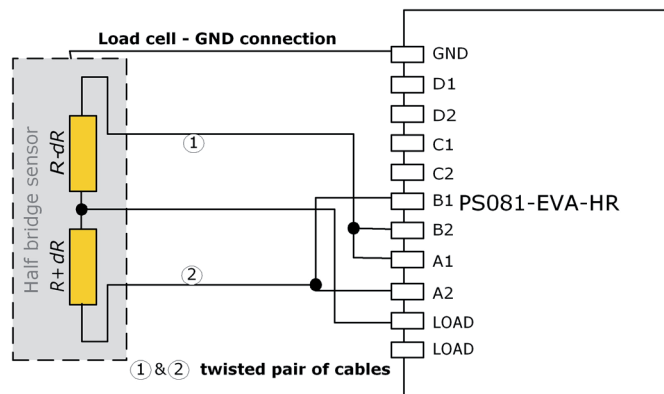

2.1.4 Fullbridge

For PICOSTRAIN a full bridge is ideally separated into two half bridges. This wiring can increase the resolution compared to Wheatstone bridges by 0.6 bit.

Figure 3 Connecting a fullbridge

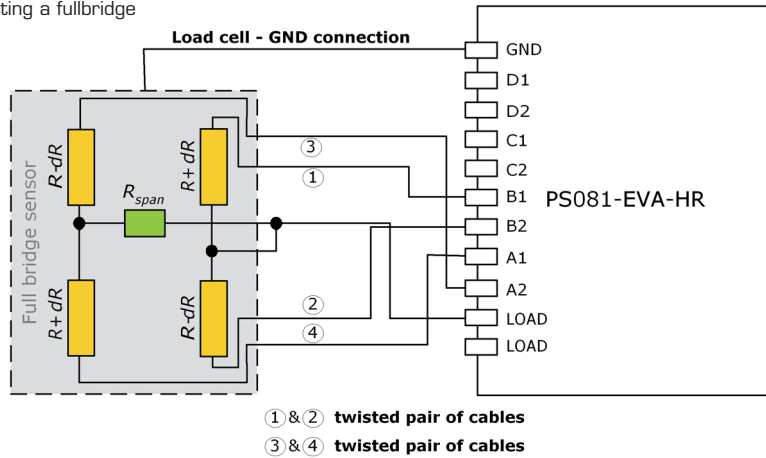

Existing sensors with Wheatstone bridge connection might adopted just by changing the wiring according to the following picture.

Figure 4 Adaption of Wheatstone wiring to PICOSTRAIN

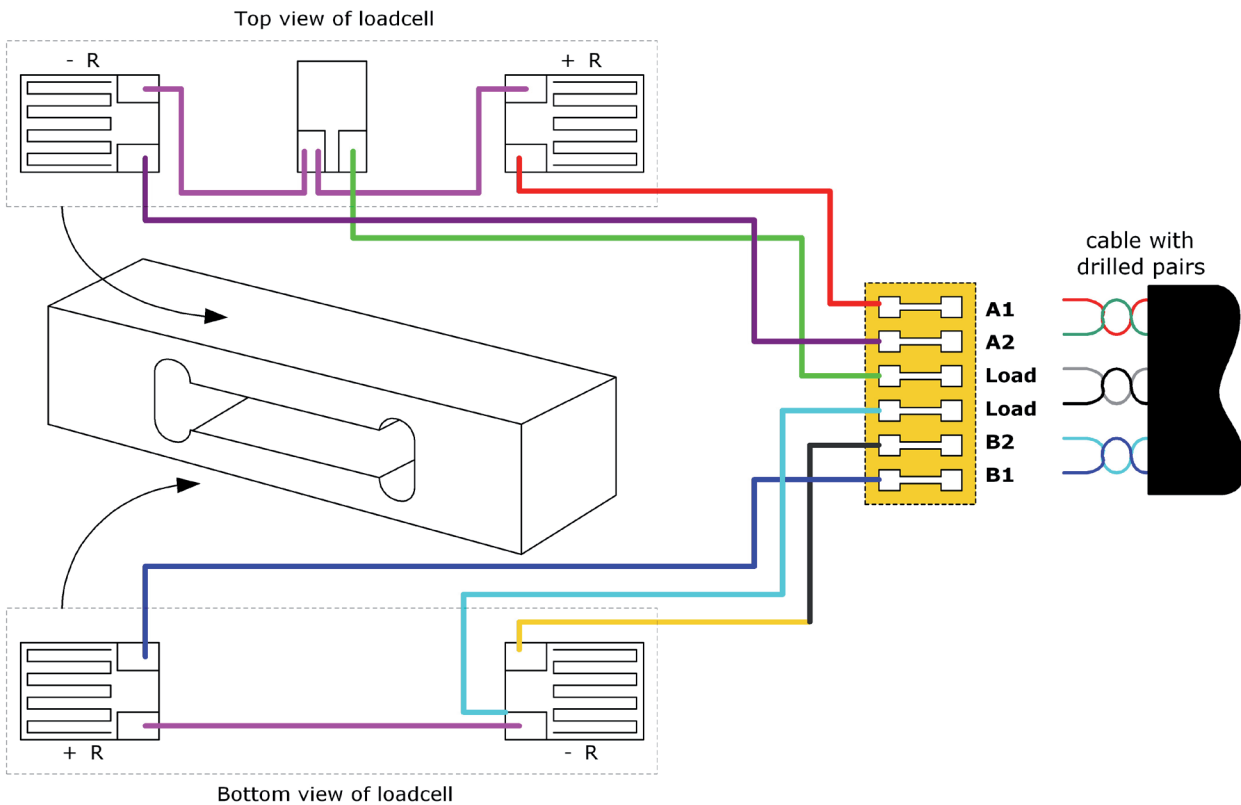

2.1.5 Quattro Mode

In quattro mode the PS081 measures 4 half bridges. The 4 half bridges are measured independently and the gain of each half bridge can be corrected separately. Typical applications are body, baby or platform scales

Figure 5 Connecting four halfbridges or two fullbridges in One sense mode

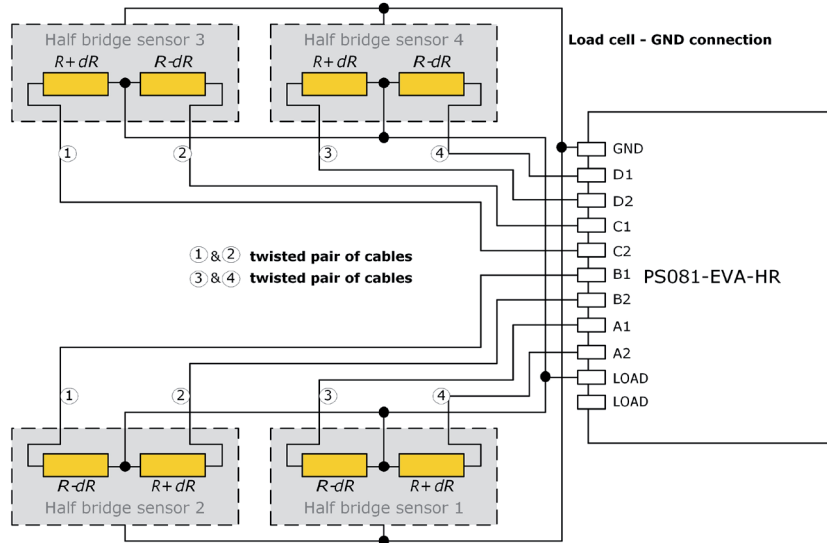

2.1.6 Modification for Solar Applications

In solar applications the reduction of the current consumption has the highest priority. The unique capability of PICO STRAIN allows to modify a full bridge load cell in a way that it becomes a half bridge with twice the resistance. So with 1 kOhm strain gauges the load cell shows a total resistance of 2 kOhm. The current into the sensor is reduced by a factor of 2. This option is reasonable in case all the strain gauges are on one side of the load cell.

Figure 6 Using a full bridge as half bridge for current reduction

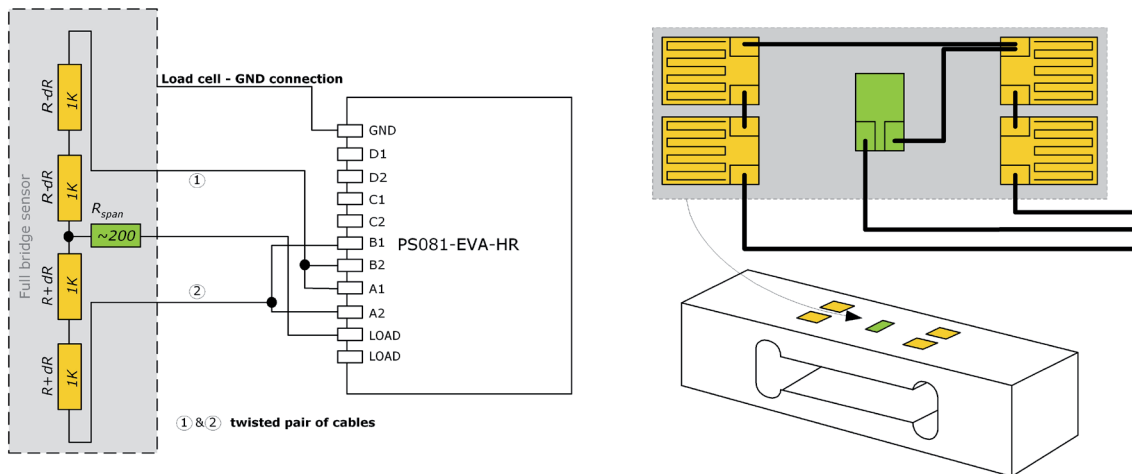

2.2 STD - Standard Module

The standard module is designed for applications with high, but not highest resolution. The internal comparator is used. This reduces the base resolution by 0.8 bit compared to the external comparator. The current consumption can be down to 100 μ A. The external circuitry is smaller and the PCB is a two layer one compared to four layers for the high resolution module.

Figure 7 Standard Module

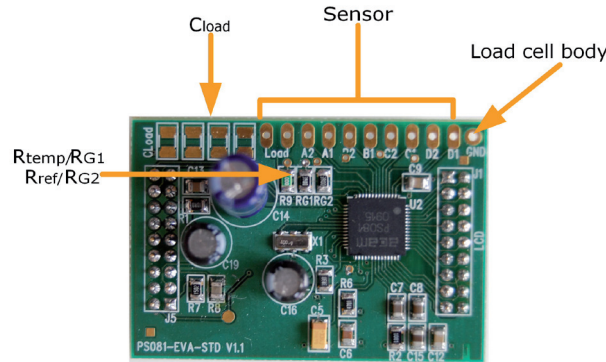

In all other respects everything is the same as for the high resolution module (section 2.1).

Note:

The standard module is shipped without Cload and RG1, RG2 being assembled. Those have to be added according to the resistance of the load cell.

2.3 WH - Wheatstone Module

The Wheatstone module offers the possibility to connect existing load cells in Wheatstone configuration without any modification. In general this will end in 0.6 bit less resolution compared to PICO TRAIN wiring. It might be reasonable to use Wheatstone bridges in case of cables longer than 0.5m.

Figure 8 Wheatstone Module

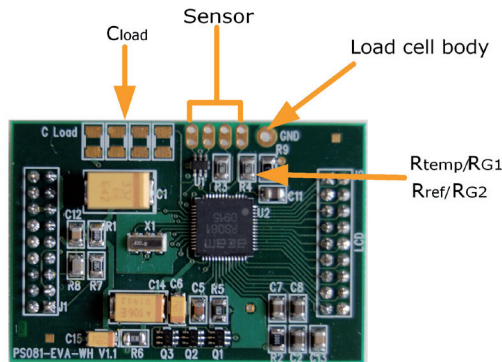

Note:

The standard module is shipped without Cload and RG1, RG2 being assembled. Those have to be added according to the resistance of the load cell.

2.3.1 Capacitor Selection and Assembly

The **PICOSTRAIN** measurement principle is based on measuring the discharge time of a capacitor. For this reason the correct size and material of the capacitors is significant to achieve best measuring results. In general we recommend a discharging time in the range of

$$\tau = 0.7 * 0.75 * R * C = 80 \text{ to } 120 \mu\text{s.}$$

As material we recommend COG or CFCAP (Multilayer ceramic from Taiyo-Yuden), X7R or Polystyrol. The recommend values are:

Rsg = 350 Ohm → Cload = 220 nF to 300 nF

Rsg = 1000 Ohm → Cload = 75 nF to 120 nF

2.3.2 Gain Compensation Resistors

The two resistors Rtemp and Rref are needed for two reasons:

Correction of the delay time of the comparator

Temperature measurement

The two resistors have to be connected in any case. In case of no temperature measurement both resistors can be of the same type (e.g. carbon resistors).

Temperature measurement is done by measuring the ratio of the discharge times of two resistors, a temperature dependent one and a temperature stable one. The sensitive resistor may be an KTY-type or even cheaper a carbon film resistor. The reference resistor can be a metal film resistor.

The resistors should have $\frac{3}{4}$ of the value as the strain gauges. The recommend values are:

Rsg = 350 Ohm → RG1, RG2 (Rtemp, Rref) = 270 Ohm

Rsg = 1000 Ohm → RG1, RG2 (Rtemp, Rref) = 750 Ohm

2.3.3 Wheatstone Bridge Connection

Figure 9 Wheatstone Bridge Connection

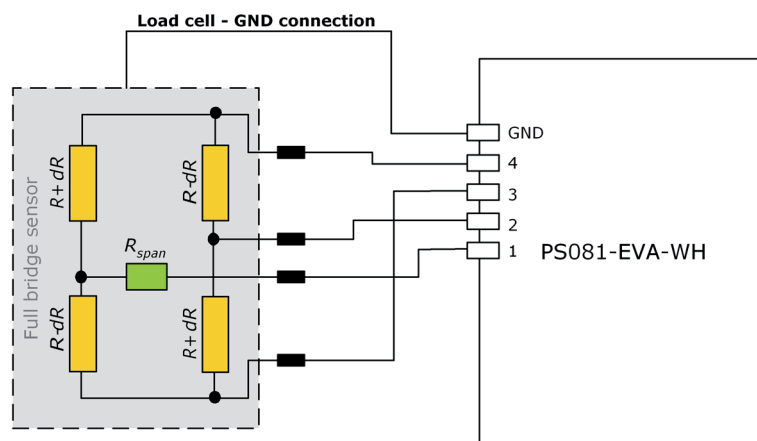

3	Motherboard.....	3-2
3.1	LCD.....	3-3
3.2	External LCD driver.....	3-4
3.3	Solar panel.....	3-4
3.4	Buzzer	3-4



3 Motherboard

The motherboard connects to the programmer. It serves the various power options. It holds the LCD and solar panel. The ten push buttons can be used in stand alone operation.

Figure 10 PS081-EVA Motherboard

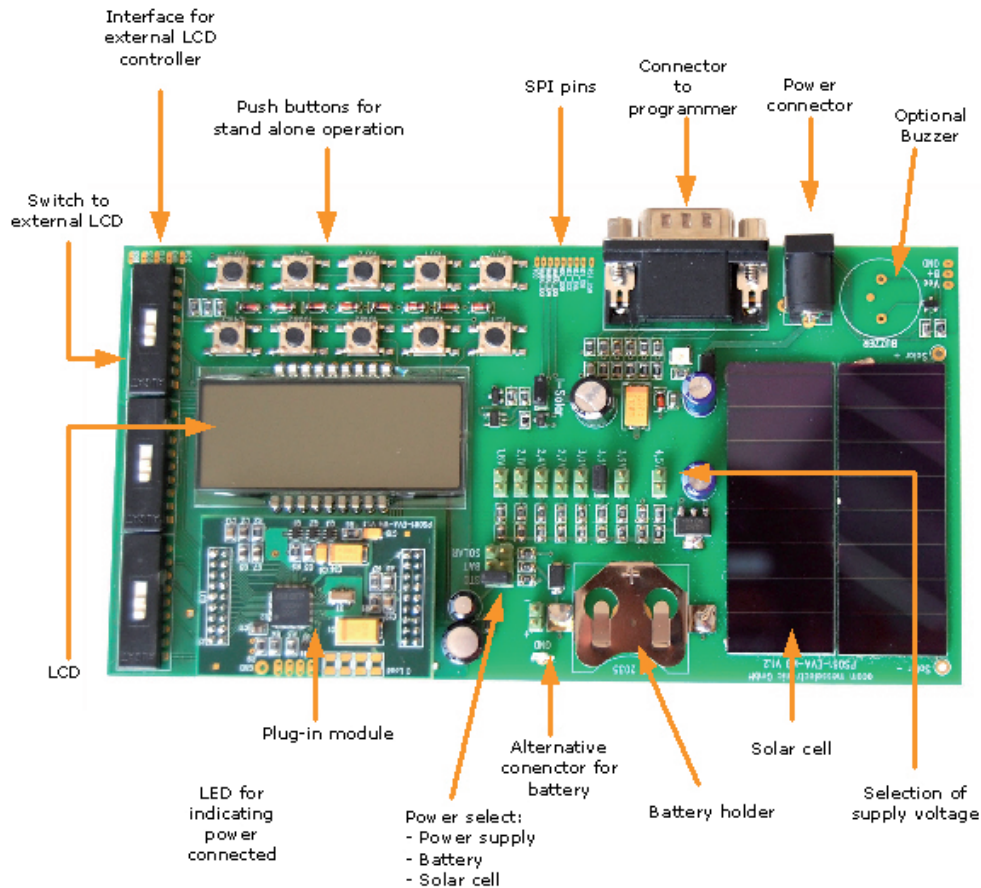

The jumpers for power select can also be used to measure the current consumption of the system.

3.1 LCD

The LCD is supplied by ADKOM Elektronik GmbH. Duty 1/4, Bias 1/3, Operating voltage 2.5V, Operating temperature 0°C to 50°C.

Figure 11 LCD

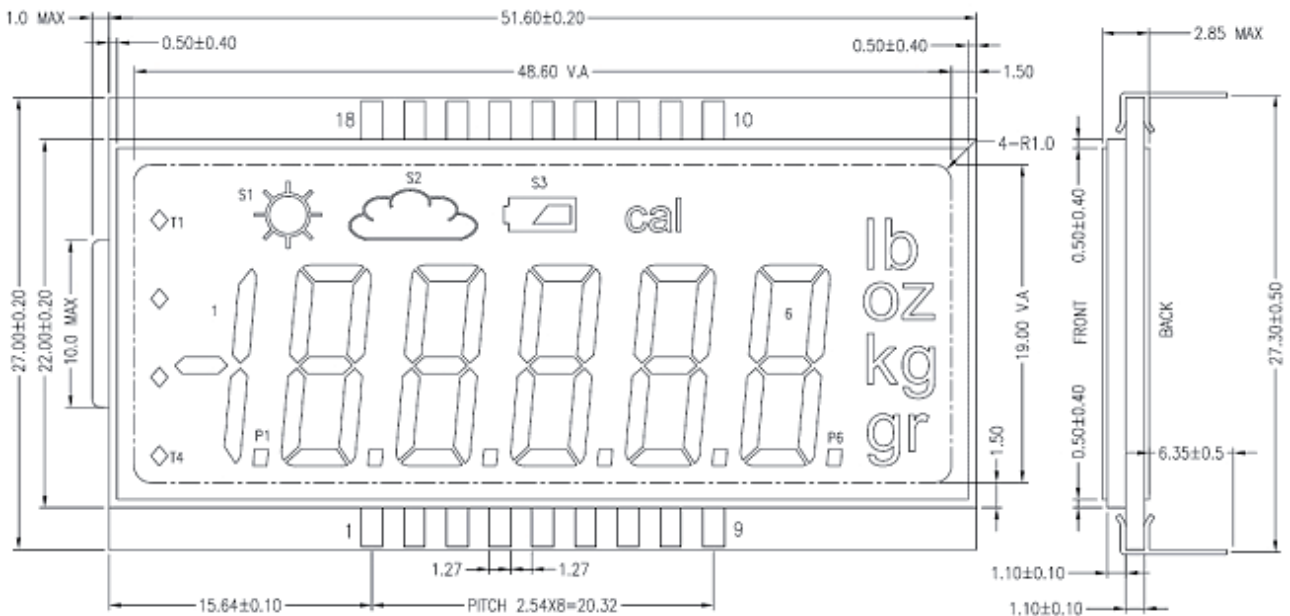

Pin	1	2	3	4	5	6	7	8	9	10	11	12	13	14	15	16	17	18
COM1	T1	1C	2A	2G	3A	3G	6A	6G	lb	S3	5G	5A	4G	4A	cov			
COM2	2	1B	2I	2B	3I	3B	6I	6B	oz	S1	5D	5I	4D	4I		0.3x2		
COM3	T3	1C	2F	2C	3F	3C	6F	6C	kg	ca	5C	5F	4C	4F			0.3x5	
COM4	T4	P1	2D	F2	3D	P3	6D	P6	gr	S2	F5	5D	P4	4D				0.3x4

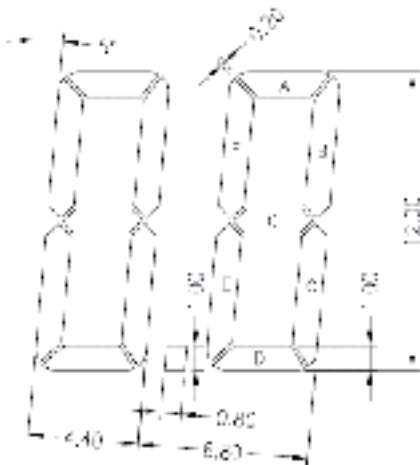

3.2 External LCD driver

PSØ81 offers the possibility to control an external LCD driver. Therefore a simplified SPI master mode was implemented, especially adopted to Holtek HT1621 and FM μ pd7225 devices.

For the SPI interface pins of the LCD driver are used. To have enough driver power up to 6 pins have to be used in parallel.

Note:

The three DIP switch select between the on-board LCD and an external driver. The external driver is selected if the switches are on the side of the solder pads for the external connection.

3.3 Solar panel

The solar cell is type SS 5520 from Sinonar for indoor applications.

Specifications:

Dimensions:	55 mm x 20 mm x 1.1 mm
Operating circuit voltage (200 lux):	2.5 V
Operating current:	14 μ A
Open circuit voltage:	4.0 V
Short circuit current:	17 μ A
Operating temperature:	-5 °C to +60 °C

Note:

In solar mode the system is driven by 3V. As the LCD is a 2.5 V type, the dark segments will be slightly visible. In the real application a 3 V LCD should be used.

3.4 Buzzer

There are solder pads to mount the buzzer which comes with the system. The buzzer is controlled by Mult_IO3. It should be mounted only if it is really used. Otherwise, with a wrong configuration, the buzzer may sound all the time.

4	Load cell	4-2
4.1	Technical Specification.....	4-2
4.2	Wiring diagram.....	4-2



4 Load cell

The evaluation system is shipped with a ready made demonstration scale connected to the high resolution module.

The load cell is model CZL601SE-10kg from Hua Lan Hai.

4.1 Technical Specification

Table 1 Technical Specification

Maximum load	kg	10
Comprehensive error C2	%F.S.	0.02
Rated output	mV/V	typ. 1.85
Non-linearity	%F.S.	0.03
Hysteresis	%F.S.	0.03
Repeatability	%F.S.	0.02
Creep	%F.S./30min.	0.02
Resistance	Ohm	350 ± 5
Compensation resistor	Ohm	42 ± 5
Compensated temperature range	°C	-10 to +40
Operating temperature range	°C	-35 to +65
Safe overload	%F.S.	120
Ultimate overload	%F.S.	150

Mechanical dimensions:	
Base plate	200 mm x 100 mm
Weighing plate	90 mm x 90 mm
Total height	70 mm

4.2 Wiring diagram

Figure 11 Wiring diagram

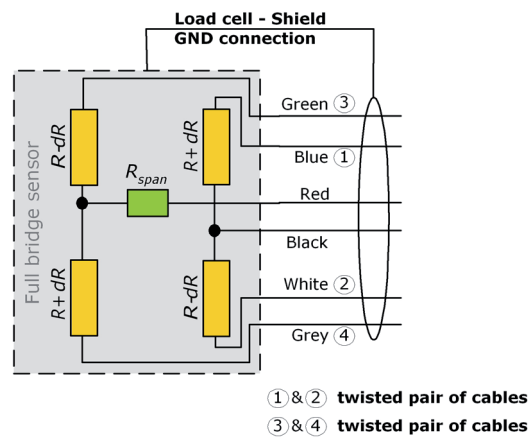

5	Evaluation Software.....	5-2
5.1	Installing the PS081-EVA Software	5-2
5.2	Running the Evaluation Software	5-3
5.2.1	Setup Page	5-3
5.2.2	Measurement Page	5-4
5.2.3	Quattro Page	5-5
5.2.4	Graphic Page	5-6
5.2.5	Front End Page.....	5-7
5.2.6	ALU Page	5-8
5.2.7	Expert Page	5-9
5.2.8	LCD Page	5-10

5 Evaluation Software

5.1 Installing the PSØ81-EVA Software

The PSØ81-EVA software is running under the following operating systems

- Windows NT
- Windows 2000
- Windows XP
- Vista
- Windows 7

The following steps have to be executed.

Note:

Please complete these instructions in the order that they appear, to avoid un-necessary complications.

1. Install the PSO81 Assembler software from PSO81-Assembler-Software\Volume1-3-xx\setup.exe
2. Run the PSO81 Assembler software once (just start it from Programs → PSO81 Assembler → PSO81 Assembler)
3. If you use Windows Vista or Windows 7 operating system the VISA runtime engine must be updated. In this case execute visa-runtime\visa41Ofull.exe. For Windows XP this is not necessary. Just continue the installation procedure.
4. Insert the programmer (PicoProg) into your PC via USB. You will be asked for a driver.
5. Please select the driver from C:\windows\system32\psO81_prg_LdrFW.sys and continue installation.
6. After installing PicoProg properly the assembler software can be used already.
(You can test to find the programmer on the ‚Download‘ page and press ‚Get Device Info‘)
7. Install the evaluation software now from PSO81-Evaluation-Software\Installer\Setup.exe
8. After installation you can use the software directly without any further steps.
9. Execute the program by selecting Programs → PSO81_USB_Vxx → PSO81_USB_vXX
————— You are ready to use the evaluation-kit from now on —————

During each step please follow the instructions on the screen to install the software.

Optionally you can see a video-tutorial about the PSO8 Assembler Software by executing the file: ASM-Screencast.exe in PSO8-Assembler-Introduction\Flash folder.

Annotation: You don't need to install the visa-runtime engine manually nor the Win2k-driver unless not advised different from acam support team. They are normally automatically installed by following the above described procedure.

5.2 Running the Evaluation Software

The software comes up with the following window:

5.2.1 Setup Page

Figure 12 Main Window of the Software

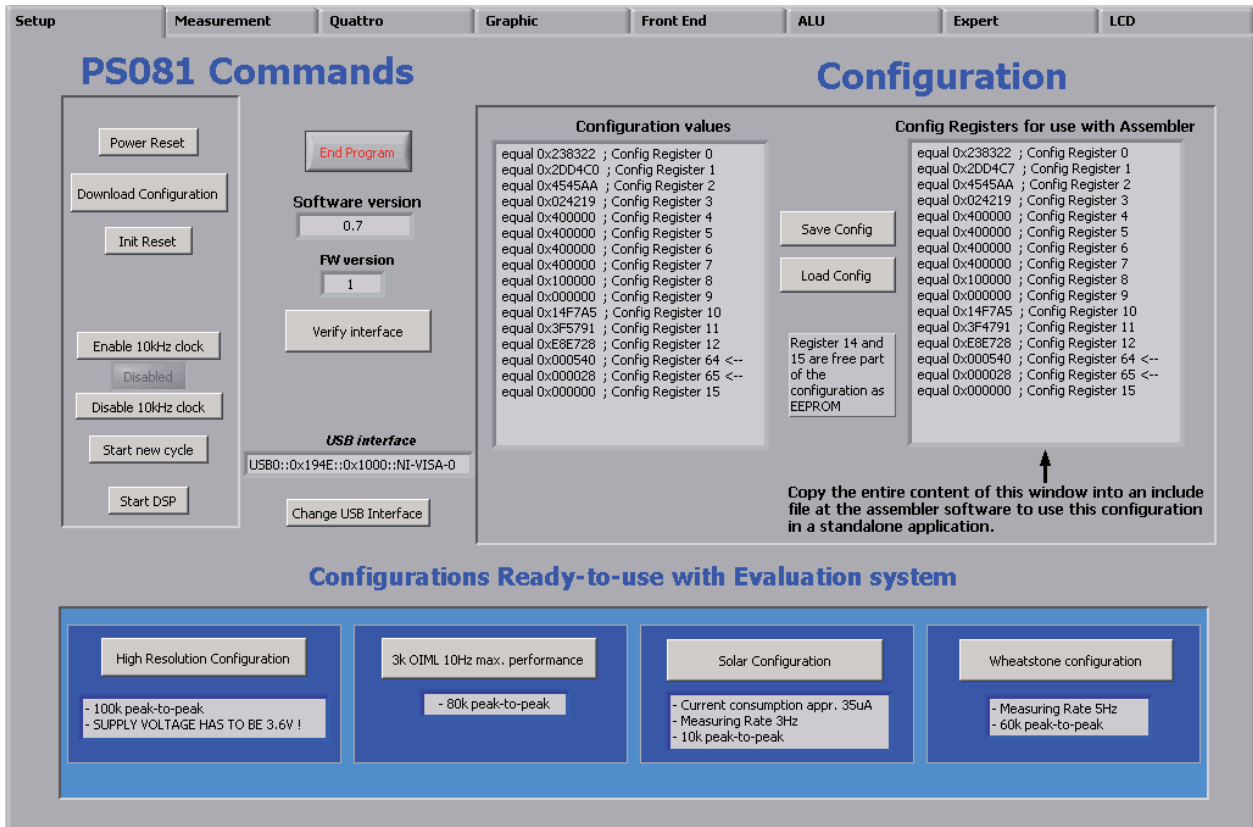

Download Configuration

Power Reset

Init reset

Start New Cycle

Enable/Disable 10kHz clock

Start DSP

Save Config

Load Config

Download the current configuration into the PS081

Power reset of evaluation board

Initialization of PS081 (keeps the configuration)

Start manually a new measurement

Switch on / off the 10 kHz by hand

Only for testing

Save actual PS081 configuration to PC

Load existing configuration from PC

Note:

It is recommended to start the PS081 evaluation by using the Ready-to-use configurations. After loading a configuration please press 'Power Reset' → 'Download Configuration' → 'Init Reset' Afterwards switch to the 'Measurement' tab and press → 'Start Measurement'

5.2.2 Measurement Page

Figure 13 Measurement Sheet

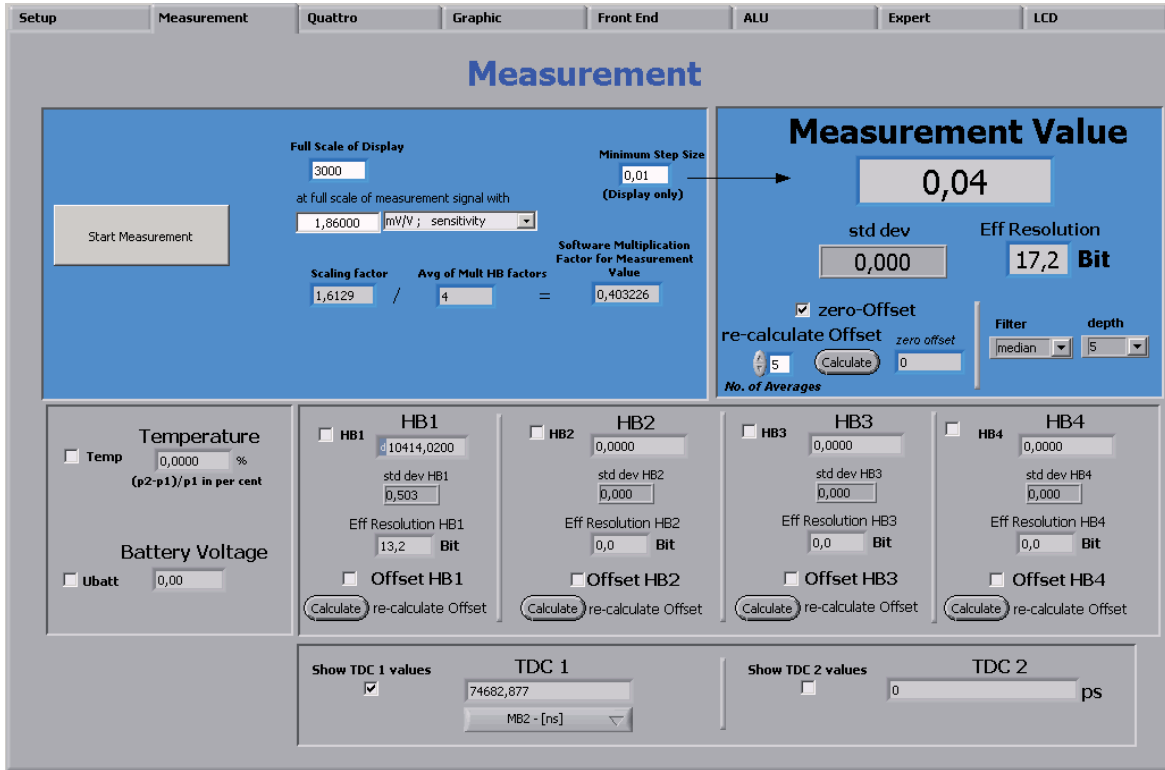

- Full Scale of Display Value that shall be displayed at maximum load
- at full scale of measurement... Sensitivity of sensor, output at maximum load
- Minimum step size Minimum step size of displayed result
- Measurement value Display of HBO result using the software filters set under "Filter".
- Eff. Resolution Effective resolution with respect to maximum output
- Filter Selection of various software filter like SINC (rolling average) and Median (non-linear filter).
- depth Depth of the filter
- re-calculate Offset Software recalculates the offset, sets back the display to 0.
- Temp Include temperature measurement result.
- Ubat Display (Rtemp-Rref)/Rref
- HB1 ... HB4 Display the results of the halfbridges
- Show TDC1 values Shows the discharge time
- Show TDC2 values Shows resolution of TDC

5.2.3 Quattro Page

Figure 14 Quattro Sheet

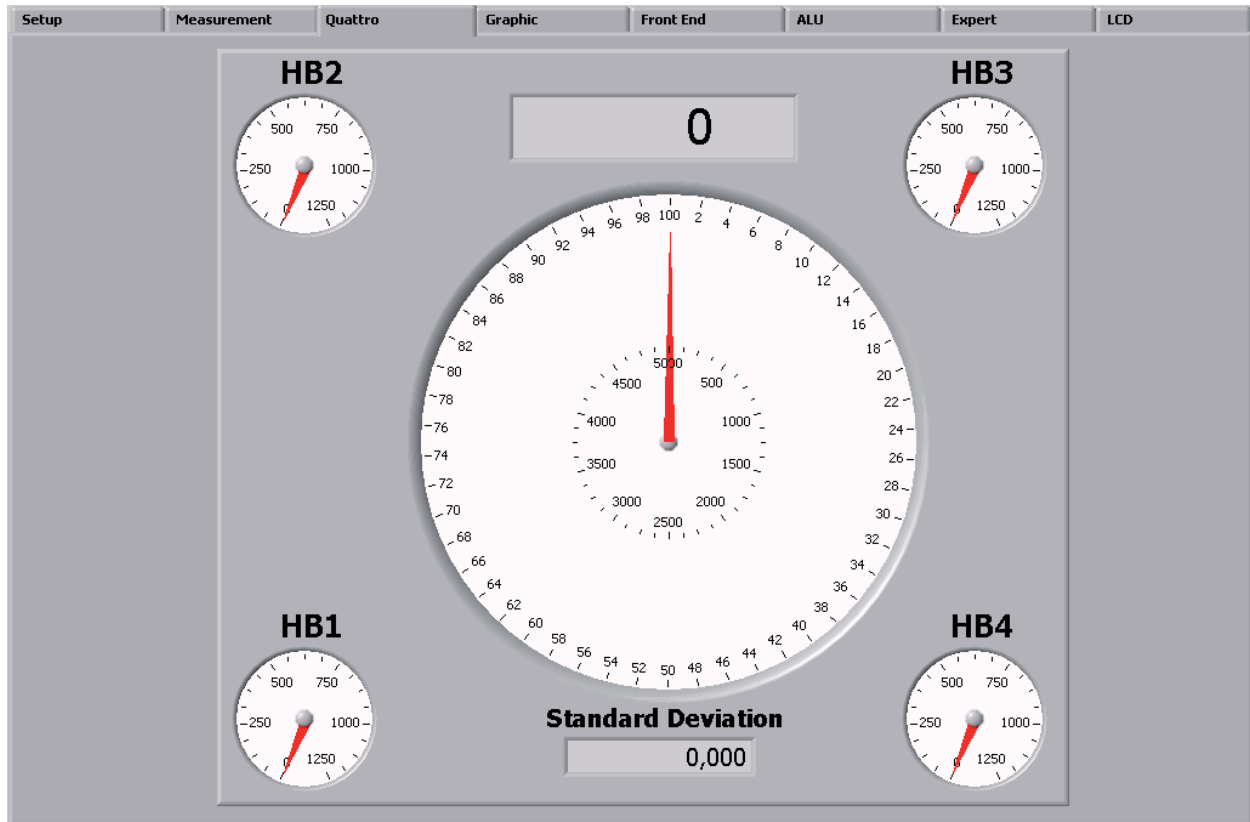

Graphical display of the four independent half-bridge results and the summarized result (center). This display is helpful when testing the behavior of quattro scales under off-center load conditions.

5.2.4 Graphic Page

Figure 15 Graphic Sheet

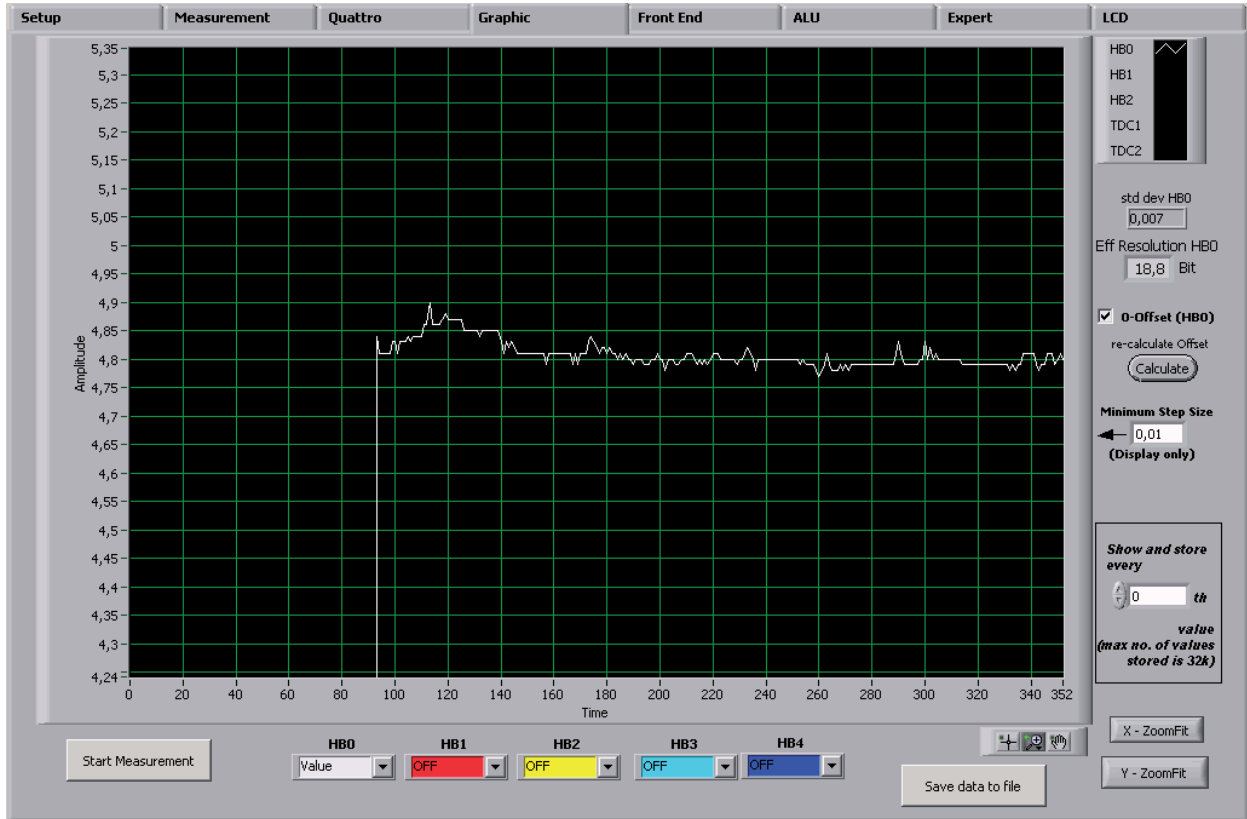

Graphical display of the results. The summary result HBO as well as the separate half bridge results can be displayed.

Pressing the → 'Save data to file' button stores the data in a text file. The size is limited to 32k values. For longterm drift investigations it is possible to store not each value. The number between values to be stored can be set.

5.2.5 Front End Page

Figure 16 Front End Sheet

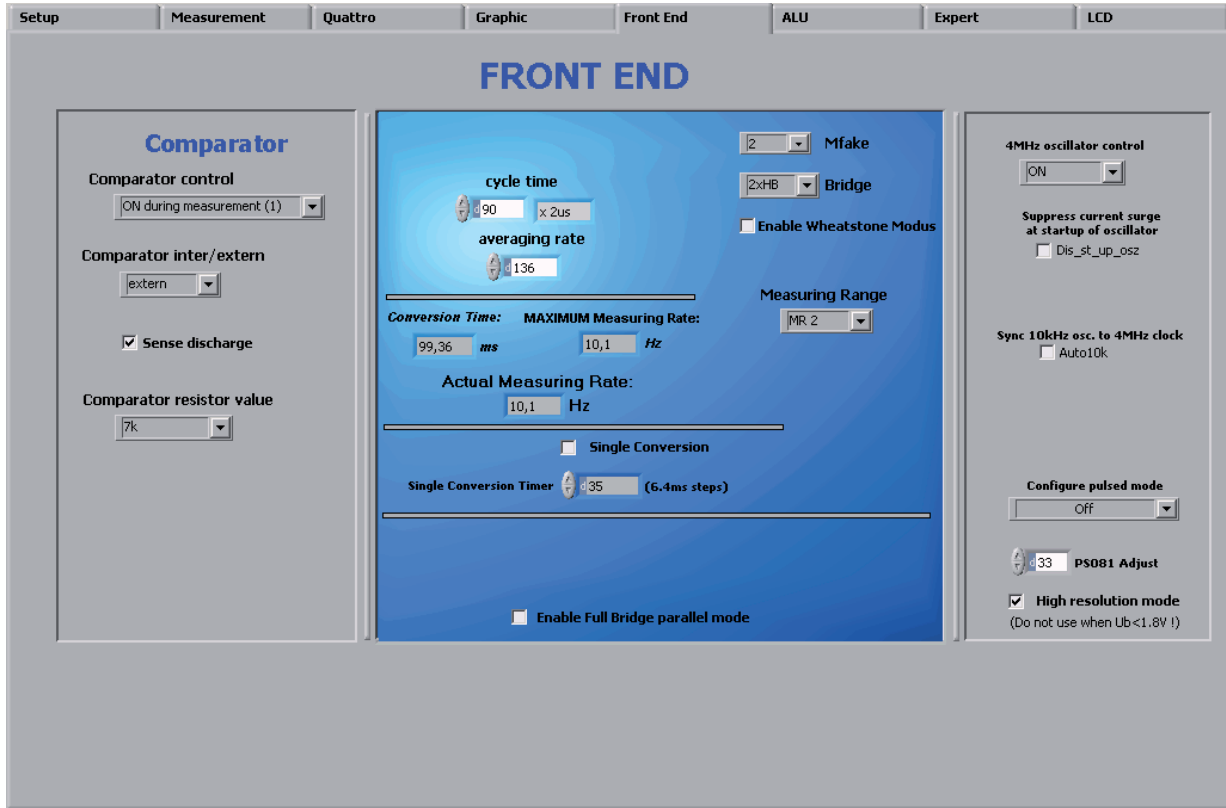

- Comparator control = con_comp: Sets the switch on behaviour of the comparator
- Comparator intern/external = sel_compint: Selection between internal comparator (Standard module) and external bipolar comparator (High resolution module)
- Comparator resistor value = sel_compr: Select comparator working resistor
- Cycle time = cytime: Set the cycle time (see section 9.2.3 of PS081 data sheet)
- Averaging rate = avrate: Set the internal averaging rate
- Single conversion = single_conversion: Selects single conversion modes. The timer defines the time interval between conversions.
- Mfake = mfake: Sets number of fake measurements.
- Bridge = bridge: Selects the number of half bridges
- Enable Wheatstone = en_wheatstone: Selects Wheatstone mode
- Measurement range = messb2: Standard is measurement range 2. Option to select range 1.
- 4 MHz oscillator control = sel_start_osz: Sets the switch on control for the 4 MHz oscillator

5.2.6 ALU Page

Figure 17 ALU Sheet

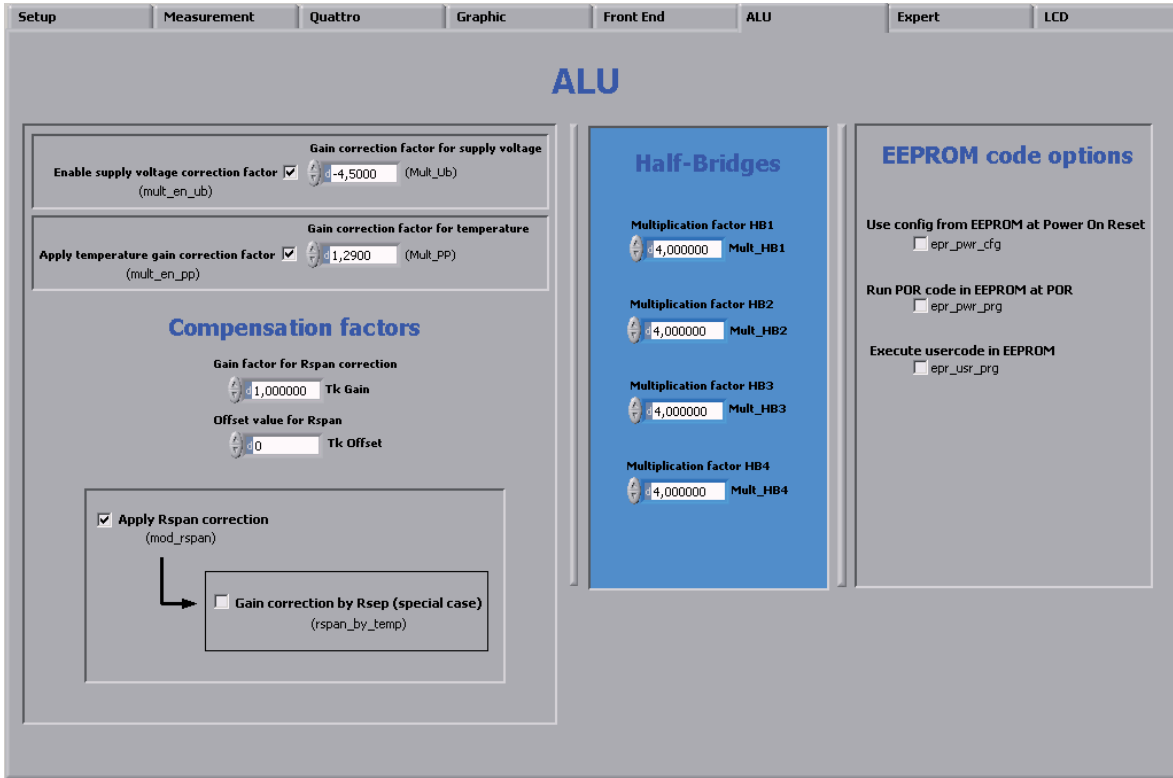

Settings for gain and offset correction.

Setting the 4 independent multiplication factors for the 4 half bridge results.

5.2.7 Expert Page

Figure 18 Expert Sheet

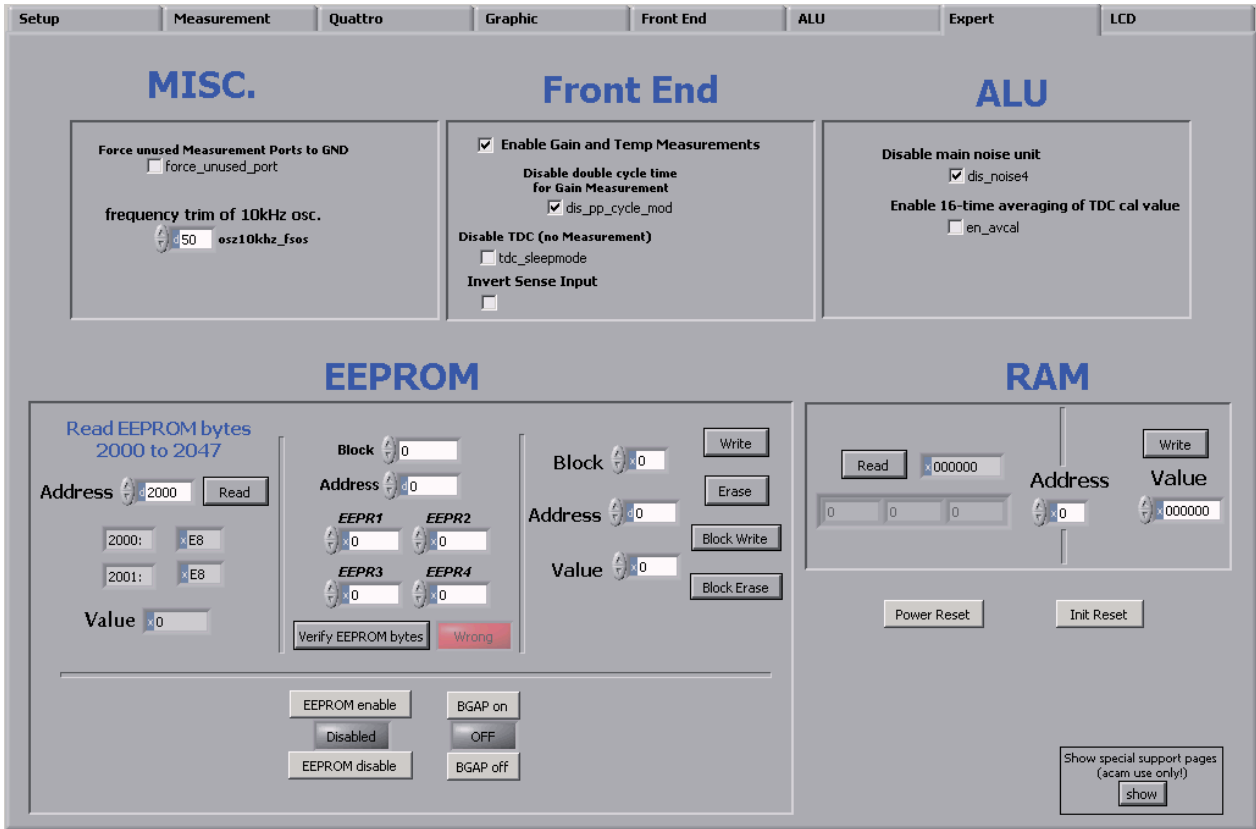

Note:

This page refers to expert setting only. Please change settings only after getting an introduction by an acam engineer.

5.2.8 LCD Page

Figure 19 LCD Sheet

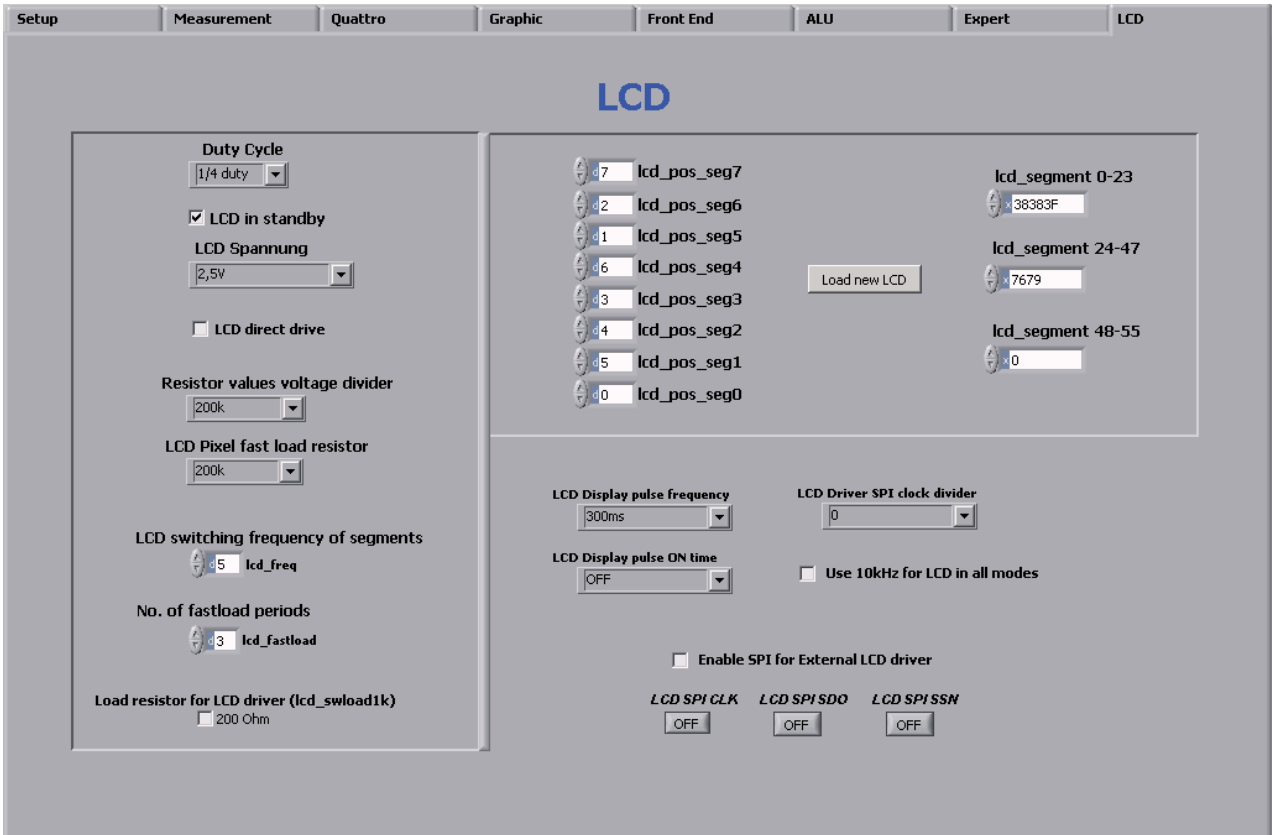

Selects the LCD duty cycle, LCD voltage (also direct drive), relevant resistor values , switching frequency and fast load periods for the LCD driver.

lcd_pos allows to adopt the LCD driver to user defined LCD's. For details please see section 8.6 of the PSØ81 datasheet.

lcd_segment allows to set the segments to be displayed when pressing 'Load new LCD'.

Setting 'LCD in standby' switches of the display.

6	Assembler Software	6-2
6.1	Installing the Assembler Software	6-2
6.2	Running the Assembler.....	6-3
6.2.1	Online Help	6-3
6.2.2	Assembler Page	6-4
6.2.3	Include Page	6-6
6.2.4	Debug Page	6-8
6.2.5	Download Page	6-10
6.2.6	Assembler Settings	6-12

6 Assembler Software

Features:

Table 2 Features

Platform:	Windows 2000, XP, Vista (32-Bit)
Type of Assembler:	2-Path Assembler 1 st path: 5 internal passes 2 nd path: 1 internal pass
Source-File:	*.asm, according to the PSØ81 assembler syntax
Target-File:	output.hex, downloadable Hex-File

Instruction:	<command> [<parameter1>, <parameter2>, <parameter3>] For example: nop or incr z or add x,y or gotoBitC x, 5, case1
Comment(s):	Single line comment: ; Multi line comment: <COMMENT> ... <ENDCOMMENT>
Includes:	Including files is possible with: #include "myfile.h"
Constants:	Constants can be defined with: CONST myConst8 15
Number formatting:	Numbers can be written in decimal or hexadecimal notation e.g.: add x,20 or add x, 0x14
Jump labels:	To jump within the code, you can use jump labels together with goto. E.g.: goto case1 case1: move x,y
Addressing:	Addressing is automatically done by the assembler. Please note, that you must provide at least 48 bytes of configuration data, maximum are 1024 bytes of user programmable space.
Subroutines:	Subroutines can be executed with the special opcode 'jsub' and 'jsubret'.

6.1 Installing the Assembler Software

Insert the CD-ROM. Run \PSØ81-Assembler-Software\Volume1-3-3\setup.exe to install the program.

Restart the computer if required. After the installation you will find in the START menu an item "PSØ81 Assembler". Run this to start the assembler program.

6.2 Running the Assembler

In the START menu there is an item “PS081 Assembler”. Run this to start the assembler program.

6.2.1 Online Help

The following sections give just a short description of the assembler program. For a detailed description of the assembler software please use the online help of the program. The online help can be opened from the Menu or by pressing the F1 button.

Figure 20 Help Menue

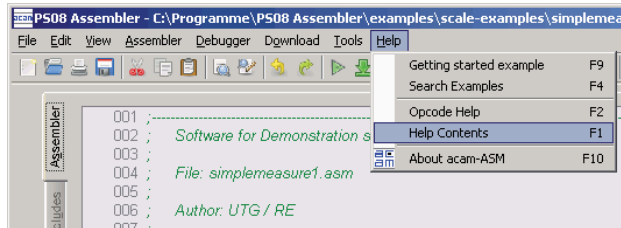

The following help window opens up:

Figure 21 Help Window

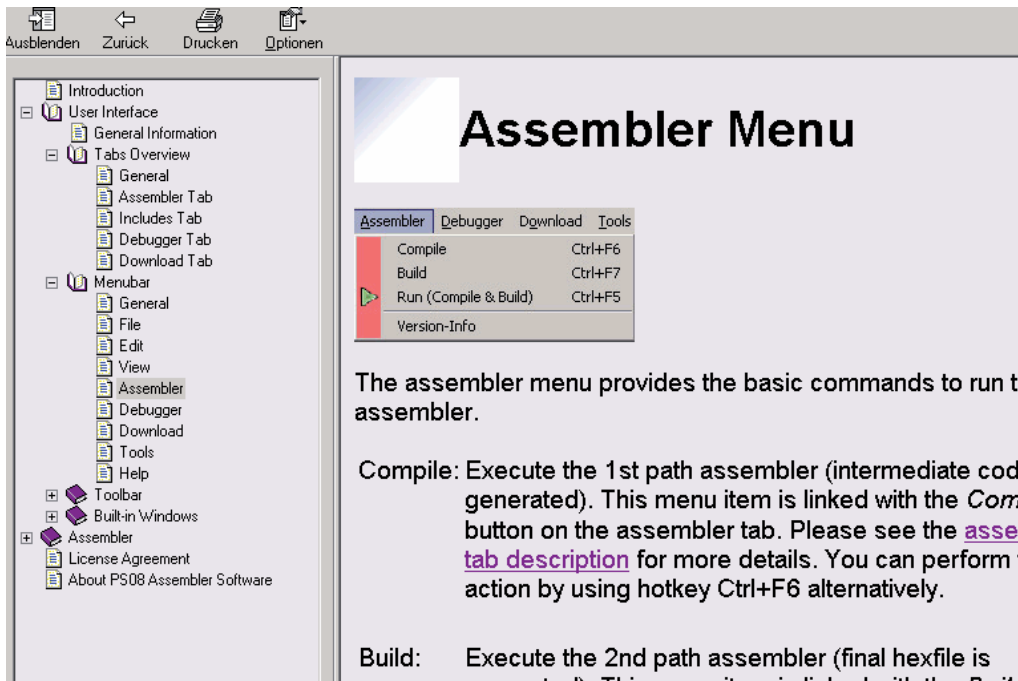

6.2.2 Assembler Page

Figure 22 Assembler Page

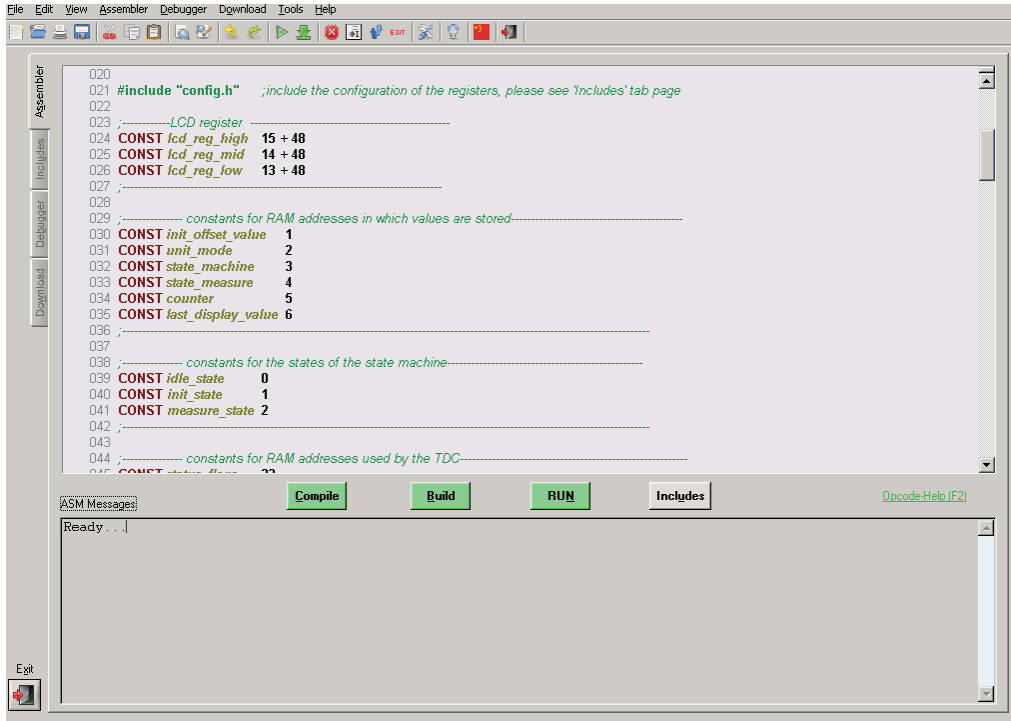

The assembler tab page consists mainly of a source code window, a status message window and buttons to operate the assembler. By clicking the green link labeled ‘Opcode-Help (F2)’ an integrated online help pops up which provides detailed information about the available opcodes.

The controls in detail:

Source code window: This window is the source code editor for the assembler listings (*.asm files). The source files can be fully edited there. Additional features are line numbering, syntax highlighting and integrated comment handling. Standard editor tasks like cut, copy & paste or find & replace, etc. can be performed. You can modify the settings for the editor via the tool settings dialog.

Assembler buttons: The assembler related buttons are: Compile, Build, Run and Includes. While clicking to the Includes-button leads you directly to the include tab, the other three buttons operate the assembler itself. As the assembler operates as a 2-path assembler - which means that in a first step the source file is assembled to intermediate code and in a second step from intermediate code to a downloadable hex code - there are several possibilities to perform this steps.

With *Compile* you execute the 1st path assembler (intermediate code is generated).

With *Build* you execute the 2nd path assembler (the final hexfile is generated).

Pressing the *RUN* button combines the two steps mentioned above.

If the assembly run was successful a message is displayed accordingly. If the compiling fails, an error message occurs.

Status message window: In this window there are the output messages of the assembler displayed. In case the assembly process was successful, a corresponding message appears. If an error occurs while assembling, an error message appears together with an exit code.

Opcode-Help: Between the source code window and the status message window there can be found a green link labeled 'Opcode-Help (F2)'. By clicking this link another window pops up. The window contains the opcode online help. Every available opcode is explained there very detailed. The additional windows is based on the integrated Microsoft Windows® Help system and can be operated separately. (Windows is a trademark of Microsoft Corporation)

Running the assembler in order to compile your source file is the first step when using the PSØ81 Assembler Software. Further steps like downloading the hexfile or using the debugger are based on a successful assembler run. In case there occur any errors please correct your source code and run the assembler again.

A getting started example can be loaded via the help menu or by pressing F9. An integrated 'Search Examples' module provides loads of examples related to the assembler structure itself as well as specific applications like programming weighing scales, accessing the RAM or displaying something on the LCD. The Search-Examples dialog box can be accessed via the help menu or by pressing F4.

6.2.3 Include Page

Figure 23 Include Page

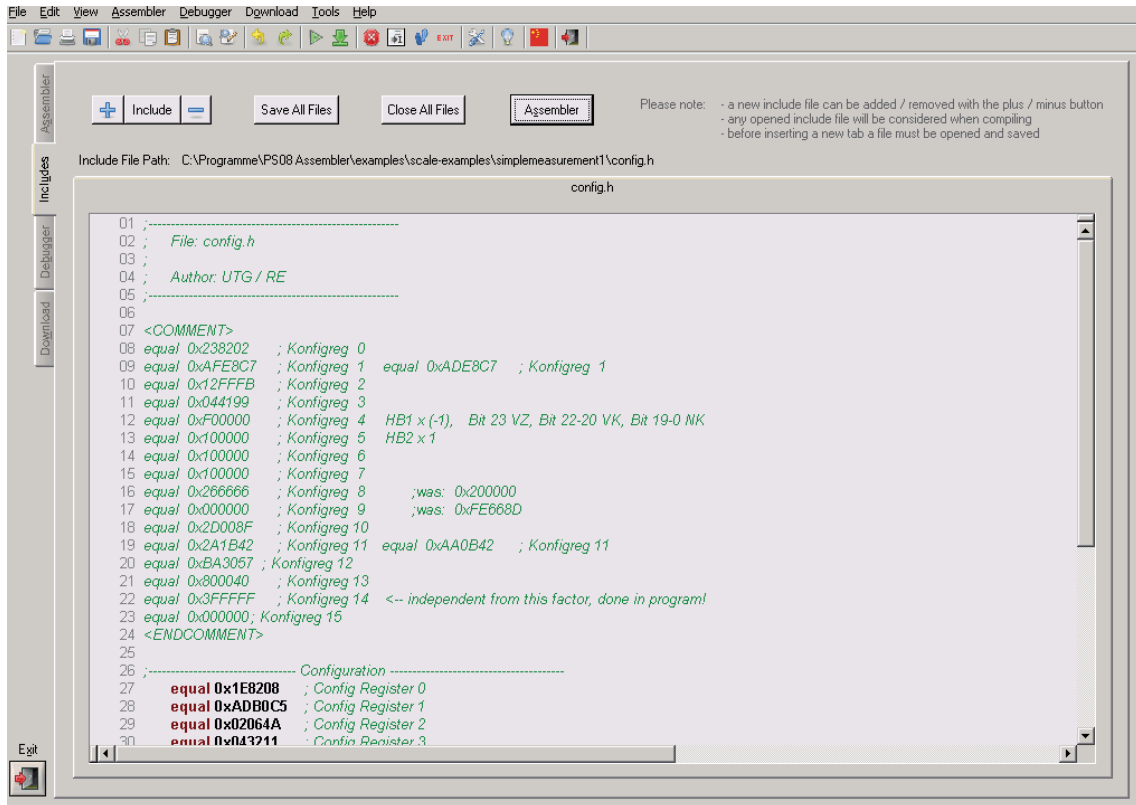

The includes tab consists mainly of one or more source code windows and several buttons to handle the include files. Generally the opened include files are considered when an assembler run is initiated. There can be up to 5 include files handled on the includes tab.

The controls in detail:

Source code window: The source code window allows the user to display and edit up to 5 include files (*.h files). The files can manually be opened, saved and closed. The properties of the editor are the same as on the assembler tab page. That means, features like line numbering, syntax highlighting and comment handling are also included here. Settings for the editor can be modified using the tool settings dialog box.

In order to include the files in your assembler listing, a special directive is needed:
#include "config.h" <- where config.h is opened on the includes tab

Include buttons: There are several buttons on this tab page: +/- Include, Save All Files, Close All Files and Assembler. Except the button Assembler - which is used to switch to the assembler tab page - all the other buttons are used to handle the include files.

+/- Include: administrate the number of active tabs via this two buttons. You can add another window by pressing '+' and close a tab by pressing '-'. You can have 5 tabs as a maximum to be active.

Save All Files / Close All Files: save resp. close all files which are currently opened on a tab.

The basic idea of this include tab is to provide more modularity and flexibility within your coding. That means, instead of packing all needed source code to a single assembler listing (*.asm files) you can roll out some pieces of code to other files (the include files, also called header files with extension *.h). The advantage of this method is, that the readability of your code will be improved and that once written parts of code can be reused (e.g. configuration information).

To include parts of code by using a include file there are two steps needed.

Step 1: open the include file on the includes tab (e.g. config.h).

Step 2: declare the inclusion in your assembler listing in the way: #include „config.h“

Of course the includes tab only offers the possibility to realize your coding in the described way. The alternative that you are just using single assembler files without using include files does exist furthermore.

6.2.4 Debug Page

Figure 24 Debug Sheet

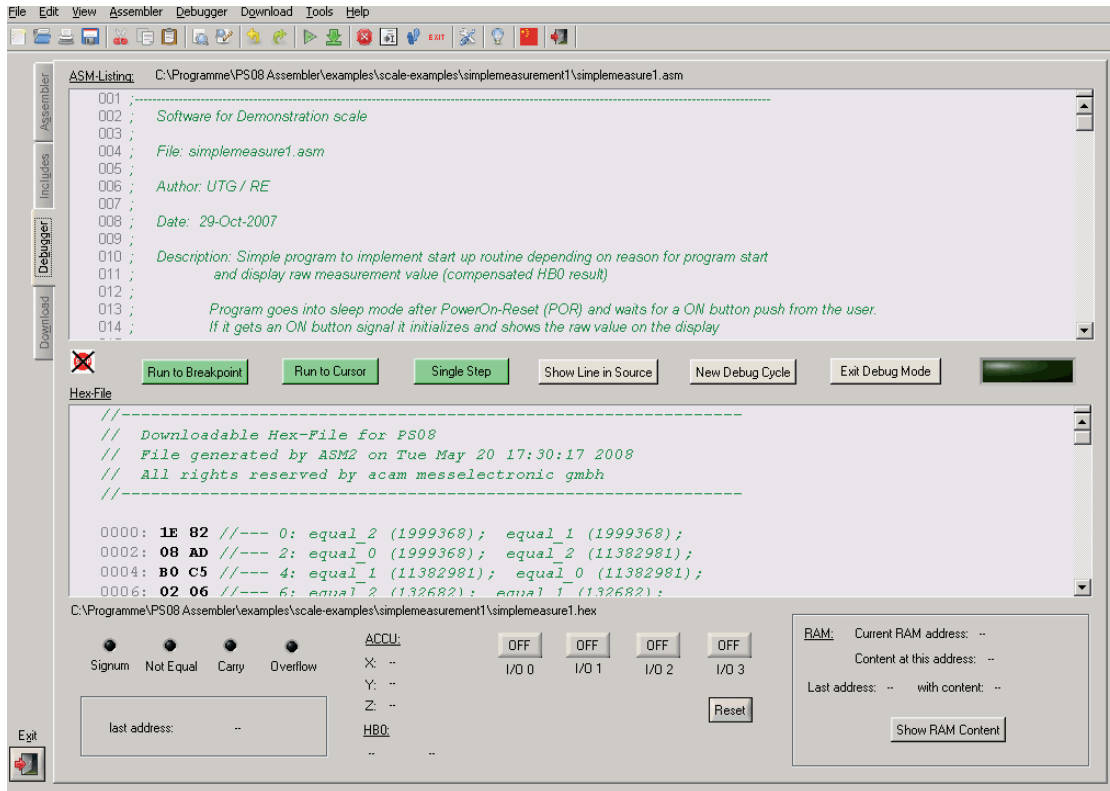

This tab provides a powerful debug interface. On this page you can debug the programs you wrote and make the processing of the code transparent. There are many data additionally available, e.g. status of the flags, content of the accumulator registers x,y,z or the content of the RAM. It is even possible to emulate the I/O-buttons including the reset button. An active debugging process is indicated by a LED. There are several debug-modes available.

The controls in detail:

- Source Code Window:** The source code is shown in this window again (read-only). It is possible to set breakpoints on the left column of the window (next to the line numbering). During the debug process the line which is currently processed will be highlighted.
- Hexcode Window:** The corresponding hexcode is displayed in this window. During the debug process the line of the last received opcode will be highlighted yellow.

Debug Buttons: There are six buttons available to control the debug process:

- Run To Breakpoint: set a breakpoint on the left column by double-clicking in it. Pressing the button let the debugger run until the breakpoint is reached.
- Run To Cursor: place the cursor in any line in the Source Code Window and press the button. The program will be processed until the line where the cursor is placed currently.
- Single Step: press this button and one single instruction will be performed at a time. This mode is well suited for watching the step to step processing, e.g. the jump to a subroutine.
- Show Line in Source: as you cannot edit the source file in this window you need to make any modifications in the original source window on the assembler tab page. To make it easier to find the current line on the assembler tab page you can press this button. The corresponding line in the source code will then be highlighted.
- New Debug Cycle: by pressing this button the debug mode is exited and entered explicitly. That means also, that all settings are cleared.
- Exit Debug Mode: by pressing this button the debug mode is exited
- LED indicator: the LED indicates the current status of the debugger. If it is grayed the debugger isn't active. An active debugger is indicated through a orange-colored LED labeled with 'RUNNING' on it.

Debugging information: In this area of the tab there are additional information shown belonging to the last processed instruction. For example, the corresponding address is shown, the state of the flags and the content of the accumulator registers x,y,z.

I/O and Reset buttons: This buttons give the opportunity to serve the I/O ports of the PSØ81. The configurable inputs can be emulated this way (in other words, a program can be debugged with a 'pressed button functionality'). The reset button performs a reset of the PSØ81.

RAM information: In this area some RAM information is shown. While the last & current RAM address plus content is shown every time, you can press the button 'Show RAM content' and you will get another pop-up window where you find the RAM content of address 0..31.

The debugger tab page gives you the possibility to run your program step by step or only parts of it and a lot more. Additional information is obtained which is normally not obvious. You can even combine several debug modes at runtime.

Please run the assembler on your listing first and make sure the file is processed successfully. Download the hexfile then and switch then to the debugger tab. You should be able to debug the file now.

6.2.5 Download Page

Figure 25 Download Sheet

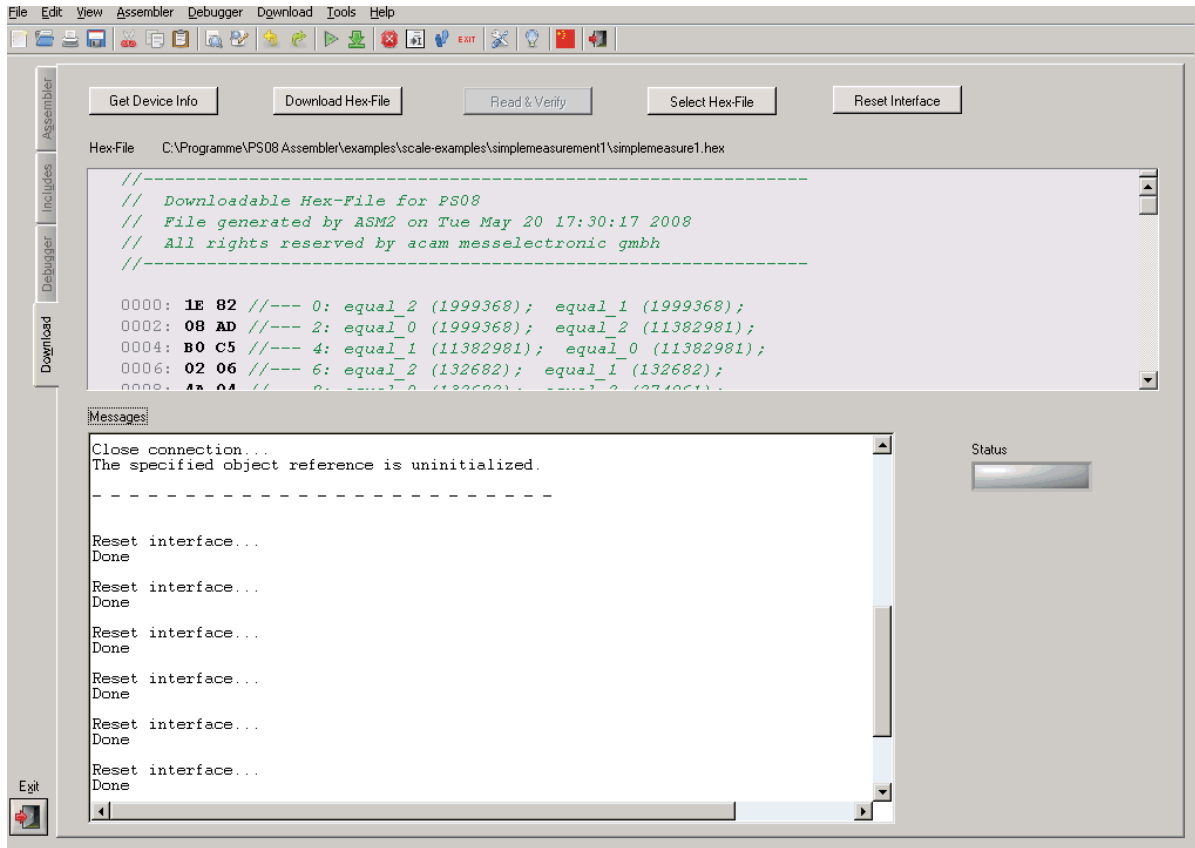

The download tab provides an interface to program the PS081 with the compiled hex code. For this purpose the hex-file is displayed and several buttons are provided to handle the download. A big message window shows the status of the connection and the programming. Furthermore a LED indicates success or failure of the download.

The controls in detail:

Hex code Window: The previously compiled hex-file is displayed in this window. Furthermore the path to the file is displayed above the window in order to have the possibility to check if it is the proper file.

- Download Buttons:** There are five buttons available to handle the download process:
- Get Device Info:** press this button to receive general information about the USB connection and the device itself (e.g. instrument handle, vendor-id, etc.). In case there are problems with the USB connection this button and the corresponding messages can help to find the problem's cause.
 - Download Hex-File:** by pressing this button the current displayed hex-file is downloaded to the PSØ81 EEPROM. The several steps which are performed, like erasing blocks or writing the data, can be monitored in the Status Messages Window.
 - Read & Verify:** press this button to verify the EEPROM content matches the selected hex code file content.
 - Select Hex-File:** in the case you don't want to download the currently displayed hex-file (or none hex-file is selected yet) you can choose a previously compiled hex-file via this button. By pressing this button a file select popup window appears where you can select your file. The file is displayed then in the hex code window and can be downloaded by pressing the 'Download Hex-File' button then.
 - Reset Interface:** in case there are any problems or disturbances with the USB connection, the interface can be resetted via this button. The Status Messages Window is cleared also when the button was pressed.
- Status Messages Window:** In this window there are the status messages displayed regarding the download process. The window can be cleared by pressing the 'Reset Interface' button.
- Status Indicator:** The status indicator LED shows the success of the performed action. While an action is performed the LED color is orange and labeled with 'IN PROGRESS'. After finishing the action the LED shows either 'SUCCESS' on a green background in case the action was performed successfully or 'FAILED' on a red background in case the last action failed.

Note:

Please consider, that downloading the hex code to the EEPROM is a required step to perform before you can use the debugger.

6.2.6 Assembler Settings

Different settings for the assembler and the editor can be done by selectig the item “Settings” in the “Tools” menue. Then a screen appears that show the following sheets:

Figure 26 Settings Sheet

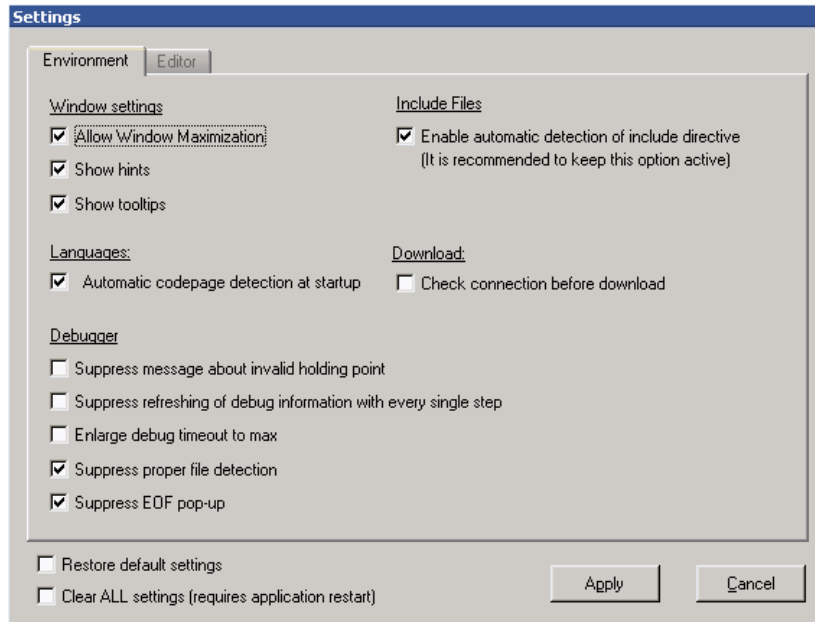
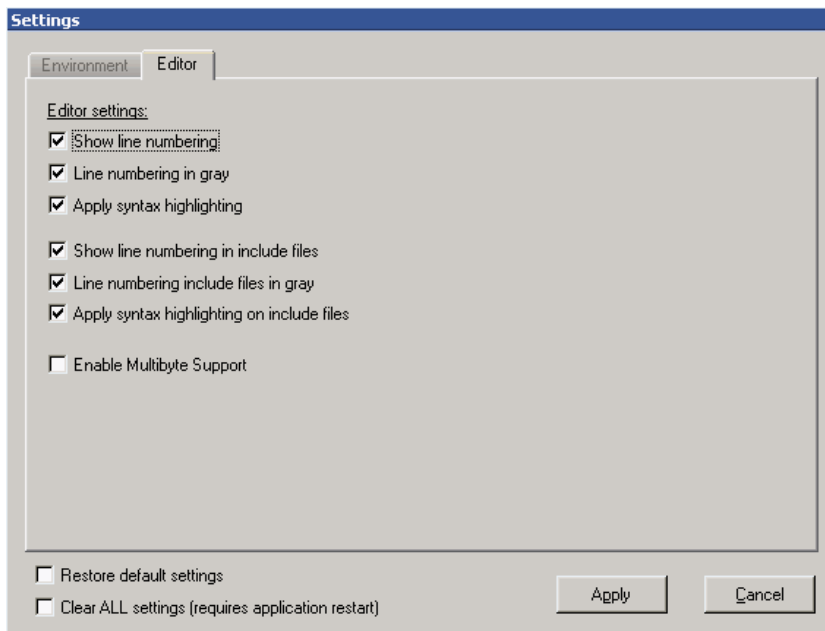

Figure 27 Editor Sheet



- 6 Miscellaneous 7-2**
- 6.1 Literature Guide..... 7-2**
- 6.2 Contacts / Distributors 7-3**



7 Miscellaneous

7.1 Literature Guide

Datasheets

Title	Document-No	Date
PSØ81 Single Chip Solution for Strain Gauges	DB_ PSØ81 VO.3	September 2009
ALCS-350 V2 Load Cell Simulator	DB_ALCS_V2 VO.1	July 2009

White Papers

Title	Document-No	Date
How to Lower Gain and Offset Drift Drift of a Load Cell by using TGGain and TKOffset Factors of PSØ81	WPO02 V1.0	October 2008
Construction Guideline for solar driven Scales	WPO01 V1.0	June 2008

Application Notes

Title	Document-No	Date
Meterological Investigations of PSØ81 Determining Zero Drift and Gain Drift	ANO18 V1.0	July 2008
Strain Gauge Wiring with PICOSTRAIN	ANO12 V1.0	August 2005
Rspan by Temp Compensation Compensation of Gain error for uncompensated Load Cells	ANO21 V1.0	July 2009
Design Guideline for Building a Solar Kitchen Scale	ANO22 V1.1	August 2009
Design Guideline for Building a Solar Body Scale	ANO23 V1.3	September 2009

All available documents can be downloaded from the acam website at:

<http://www.acam.de/download-section/picostrain>

7.2 Contacts / Distributors

Headquarter Germany	acam-messelectronic gmbh	Am Hasenbiel 27 76297 Stutensee-Blankenloch	Tel: +49 (0) 7244 7419-0 Fax: +49 (0) 7244 7419-29 support@acam.de www.acam.de
--------------------------------	--------------------------	--	--

European Distributors

Belgium (Vlaanderen)	CenS (Micro) Electronics BV.	PO Box 2331/ NL 7332 EA Apeldoorn Lamfe Amerikaweg 67 NL 7332 BP Apeldoorn	Tel: +31 (0) 55 3558611 Fax: +31 (0) 55 3560211 info@censelect.nl www.cebselect.nl
Estonia	FINTRONIC OY	Ruosilantie 14 B 00390 Helsinki	Tel: +358 9 2512 7770 Fax +3358 9 879 7770 www.fintronic.fi fintronic@fintronic.fi
Finland	FINTRONIC OY	Ruosilantie 14 B 00390 Helsinki	Tel: +358 9 2512 7770 Fax +3358 9 879 7770 www.fintronic.fi fintronic@fintronic.fi
France	microel (CATS S.A.)	Immeuble „Oslo“ - Les Fjords 19, avenue de Norvège Z.A. de Courtaboeuf - BP 3 91941 LES ULIS Cedex	Tel. : +33 1 69 07 08 24 Fax : +33 1 69 07 17 23 commercial@microel.fr www.microel.fr
Great Britain	2001 Electronic Components Ltd.	Stevenage Business Park, Pin Green Stevenage, Herts SG1 4S2	Tel. +44 1438 74 2001 Fax +44 1438 74 2001 c.jones@2k1.co.uk www.2k1.co.uk
Hungary	ChipCAD ELEKTRONIKAI DISZTRIBUCIÓ KFT	Tuzolto u. 31. 1094 BUDAPEST	Tel: +36 231 7000 Fax: +36 231 7011 szfarkas@chipcad.hu www.chipcad.hu
Italy	DELTA Elettronice s.r.l	Via Valpraiso 7/A 20144 Milano	Tel: +39 02 485 611 1 Fax: +39 02 485 611 242 flabrace@deltacomp.it www.deltacomp.it
Latvia	FINTRONIC OY	P. O. Box 99 1099 Riga	Tel: +371 297 18384 Fax: +371 671 8651 www.fintronic.fi harijs@fintronic.lv
Lithuania	FINTRONIC OY	Pramones str. 21 78136 Siauliai	Tel: +370 612 52525 Fax: + 370 41 419373 www.fintronic.fi modestas@fintronic.lt
Netherlands	CenS (Micro) Electronics BV.	PO Box 2331/ NL 7332 EA Apeldoorn Lamfe Amerikaweg 67 NL 7332 BP Apeldoorn	Tel: +31 (0) 55 3558611 Fax: +31 (0) 55 3560211 info@censelect.nl www.censelect.nl
Poland	W.G. Electronics Sp.z o.o.	ul. Modzelewskiego 35 02-679 WARSZAWA	Tel: +48 22 847 9720, +48 22847 9721 Fax: +48 22 647 0642 tgornicki@wg.com.pl www.wg.com.pl

Russia	Galant Electronics, Ltd.	100, Prospekt Mira, Moscow, 129626, Russia	Tel./Fax: +7-495-987-42-10, Tel.: +7-095-107-19-62 Mobile +7-916-993-67-57 leonid-k@galant-e.ru www.galant-e.ru
Switzerland	Computer Controls AG	Neunbrunnenstr. 55 8050 Zürich	Tel: +41-1-308 6666 Fax: +41-1-308 6655 info@ccontrols.ch www.ccontrols.ch
Ukraine	Filur Electric	off. 700, 2A Maxima Krivono- sa str. P.O.B. 180 Kiew, 03037	Tel: +380 44 2488812 Fax: +380 44 2493477 asin@filur.kiev.ua www.filur.net

American Distributors

United States of America	Transducers Direct, LCC	264 Center Street Miamiville, Ohio 45147	Tel: 513-583-9491 Fax: 513-583-9476 sales@acam-usa.com www.acam-usa.com
---------------------------------	-------------------------	---	--

Asian Distributors

India	Brilliant Electro-Sys. Pvt. Ltd.	4, Chiplunker Building, 4 Tara Temple Lane, Lamington Road, Bombay – 400 007	Tel: +91 22 2387 5565 Fax: +91 22 2388 7063 besimpex@vsnl.net www.brilliantelectronics.com
Israel	ArazimLtd.	4 Hamelacha St. Lod P.O.Box 4011 Lod 71110	Tel: 972-8-9230555 Fax: 972-8-9230044 info@arazim.com www.arazim.co.il
Japan	DMD–Daiei Musen Denki Co., Ltd.	10-10, Sotokanda, 3-Chome, Chiyoda-Ku Tokyo 101-0021	Tel: +81 (0)3 3255 0931 Fax: +81 (0)3 3255 9869 sales@daiei-dmd.co.jp www.daiei-dmd.co.jp
P.R. China	Shenzhen SECOM TELECOM Co., Ltd.	Headquarter: 32/F, Block A, ShenFang Plaza, No. 3005 Renmin Nan Rd. Shenzhen 518001 Nanjing Office: Beijing Office: Qingdao Office: Shanghai Office: Chengdu Office: Wuhan Office: Xi'An Office: Xiamen Office:	Tel.: +86 755 25155888 Fax: +86 755 25155880 zorro_huang@secomtel.com www.secomtel.com Tel.: +86 25 84552900 Tel.: +86 10 82336866 Tel.: +86 86 532 85899132 Tel.: +86 21 52371820 Tel.: +86 28 82981751 Tel.: +86 27 87322726 Tel.: +86 29 88323435 Tel.: +86 592 5806950
South Korea	SamHwa Technology Co., Ltd.	#4 4F Kyungwon building, 416-6 Jakjeon-dong GYEYANG-GU, INCHEON 407-060	Tel: +82 32 556 5410 Fax: +82 32 556 5411 www.isamhwa.com minjoonho@isamhwa.com

8	Appendix.....	8-2
8.1	Schematic Diagrams	8-2
8.1.1	PS081-EVA-MB main board	8-2
8.1.2	PS081-EVA-HR high resolution module	8-3
8.1.3	PS081-EVA-STD standard module.....	8-4
8.1.4	PS081-EVA-WH Wheatstone module.....	8-5
8.2	Layout PS081-EVA-HR	8-6
8.3	Layout PS081-EVA-STD	8-7
8.4	7.4 Layout PS081-EVA-WH	8-7

8 Appendix

8.1 Schematic Diagrams

8.1.1 PS081-EVA-MB main board

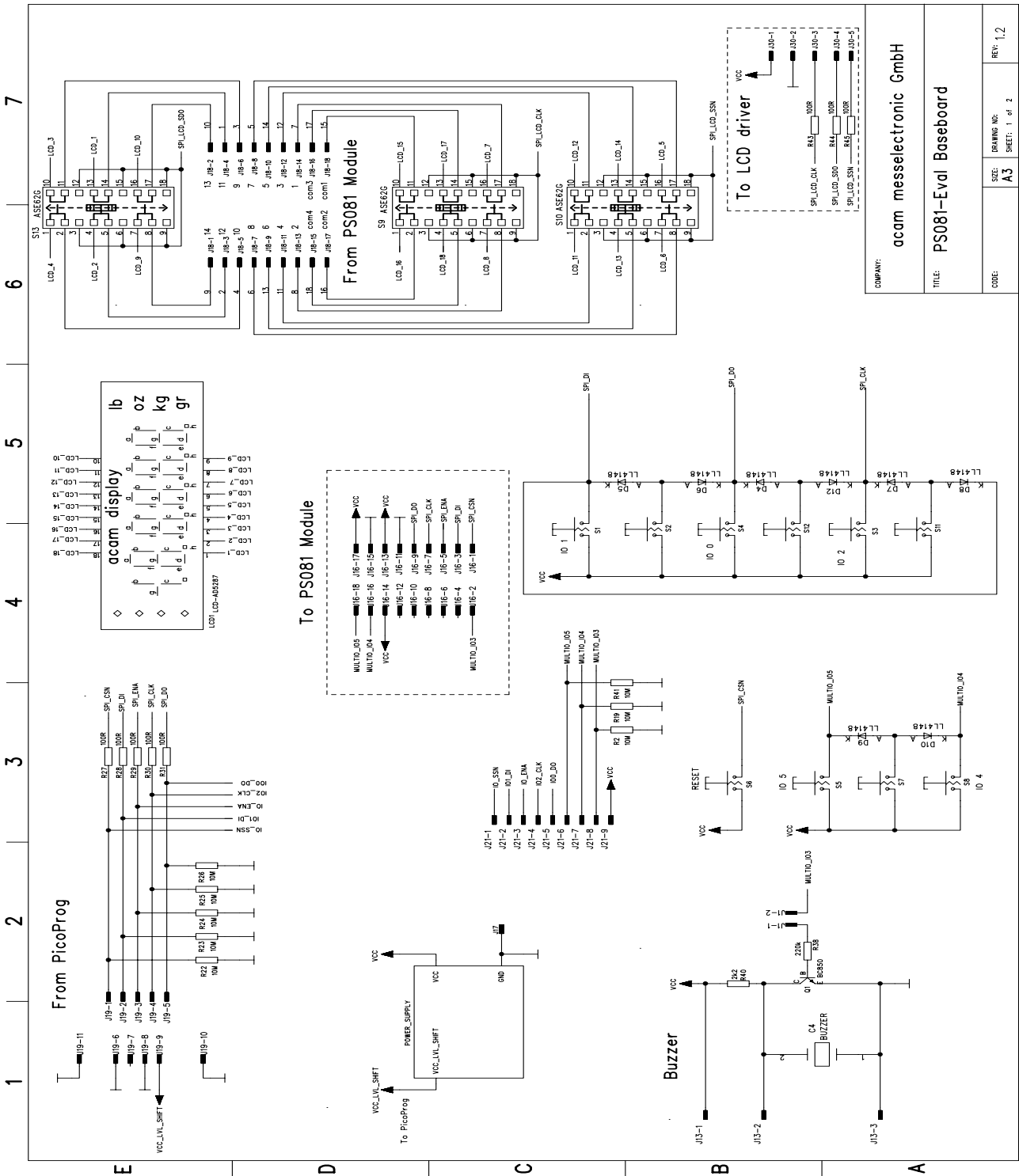

COMPANY:	acam messeletronic GmbH
TITLE:	PS081-Eval Baseboard
CODE:	
SIZE:	A3
DRAWING NO.:	
SHEET:	1 of 2
REV.:	1.2

8.1.2 PS081-EVA-HR high resolution module

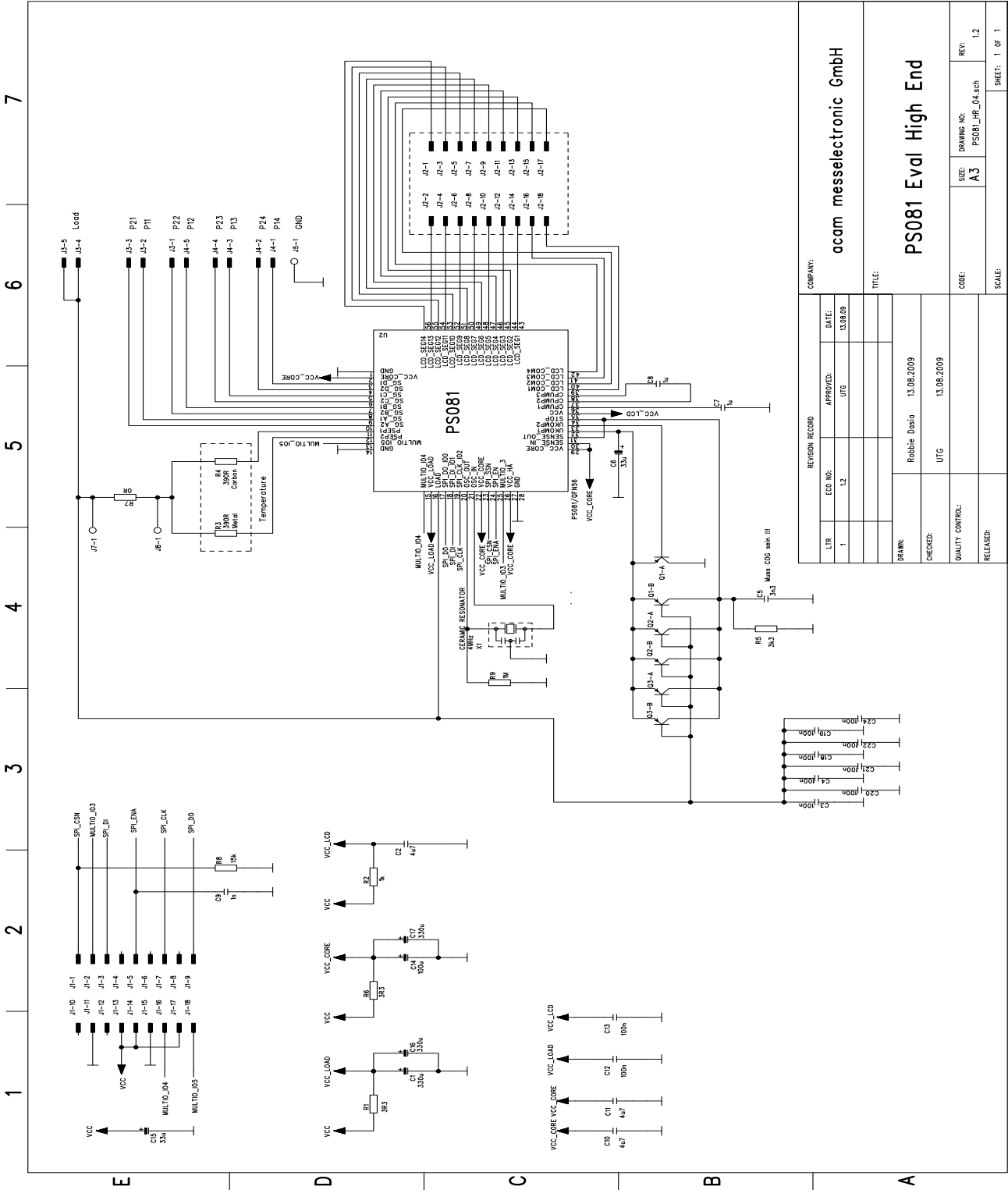

8.1.3 PS081-EVA-STD standard module

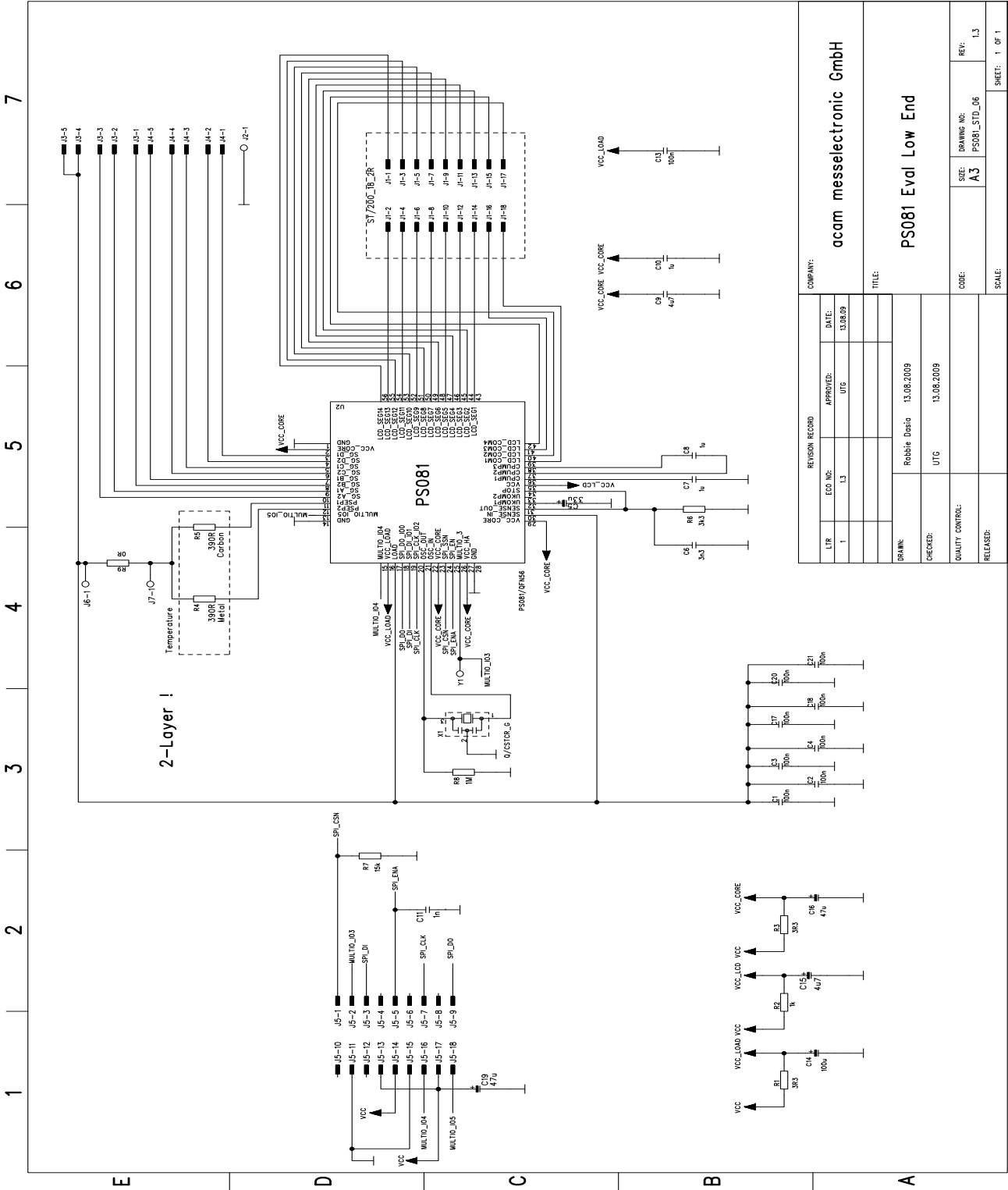

REVISION RECORD		DATE:	13.08.2009
UTR	ECO NO:	APPROVED:	UTG
1	1.3		
DRAWN:		Robbie Desio	13.08.2009
CHECKED:		UTG	13.08.2009
QUALITY CONTROL:			
RELEASED:			
COMPANY:		acam messeletronic GmbH	
TITLE:		PS081 Eval Low End	
CODE:	SIZE:	DRAWING NO:	REV:
	A3	PS081_STD_06	1.3
SCALE:		SHEET: 1 OF 1	

8.1.4 PS081-EVA-WH Wheatstone module

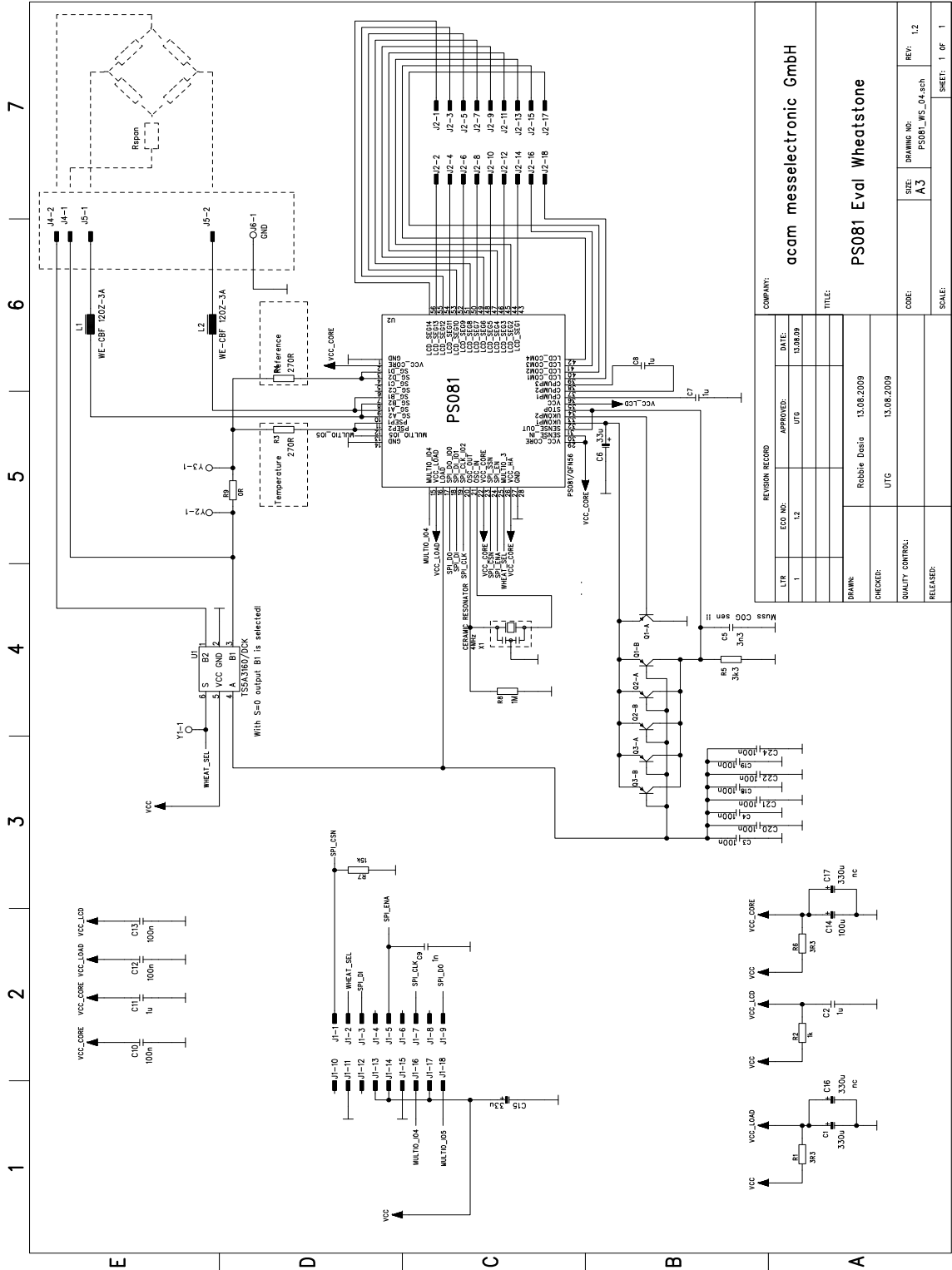

REVISION RECORD		DATE:	13.08.09
LTR	ECO. NO.	APPROVED:	UTG
1	12		
DRAWN:		Robbie Denis	13.08.2009
CHECKED:		UTG	13.08.2009
QUALITY CONTROL:			
RELEASED:			
COMPANY:		acam messeletronic GmbH	
TITLE:		PS081 Eval Wheatstone	
CODE:	DRAWING NO.:	REV.:	
	PS081_WS_04.sch	1.2	
SIZE:	A3	SHEET:	1 OF 1

8.2 Layout PSØ81-EVA-HR

Layer 1

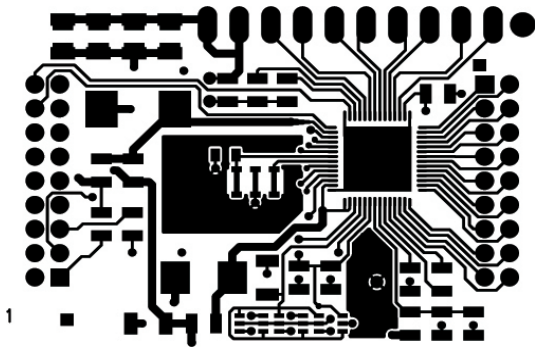

Layer 2

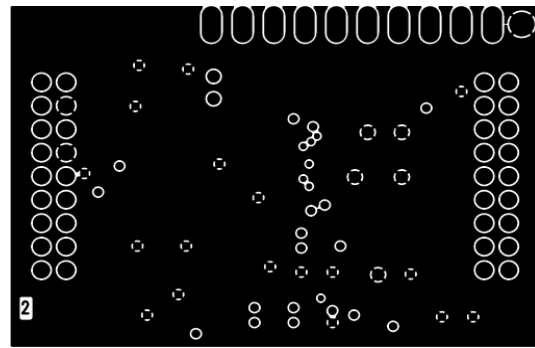

Layer 3

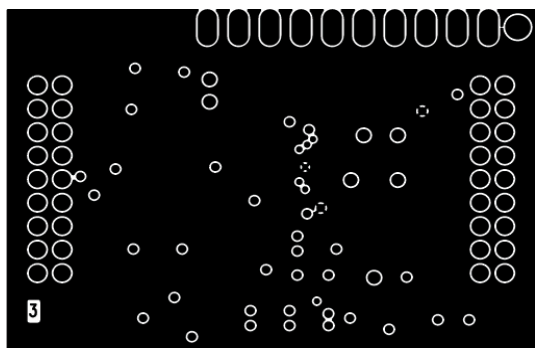

Layer 4

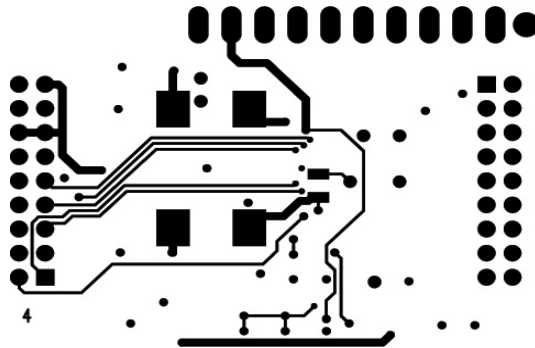

Layer 5

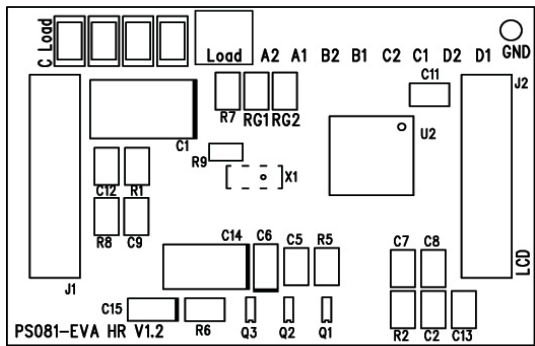

8.3 Layout PS081-EVA-STD

Layer 1

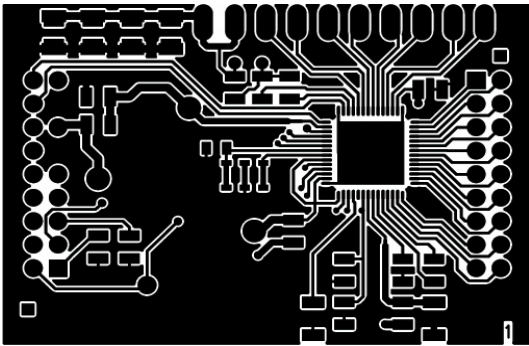

Layer 2

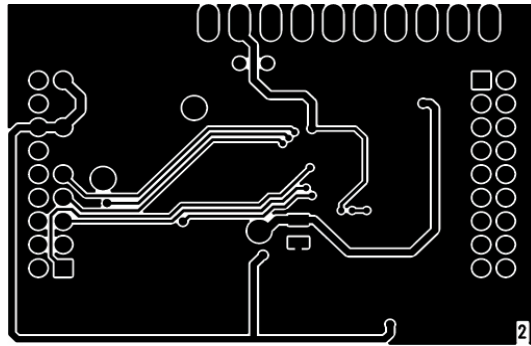

Layer 3

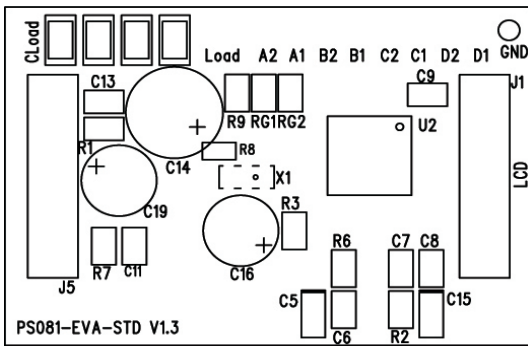

8.4 7.4 Layout PS081-EVA-WH

Layer 1

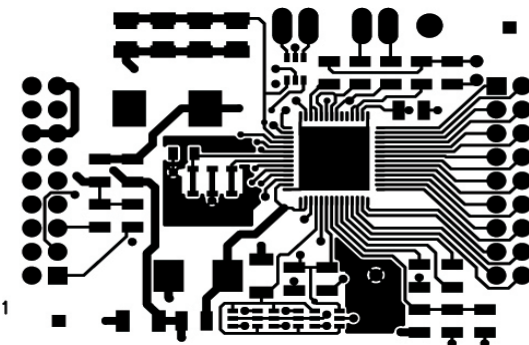

Layer 2

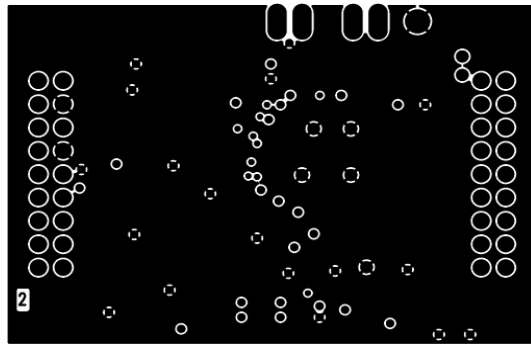

Layer 3

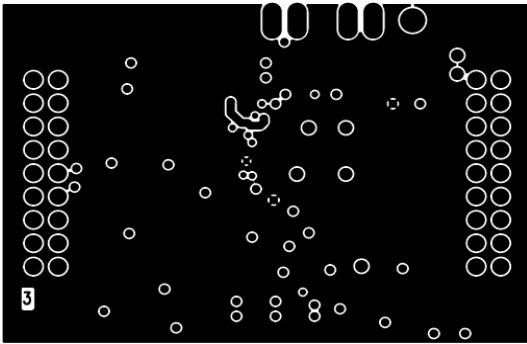

Layer 4

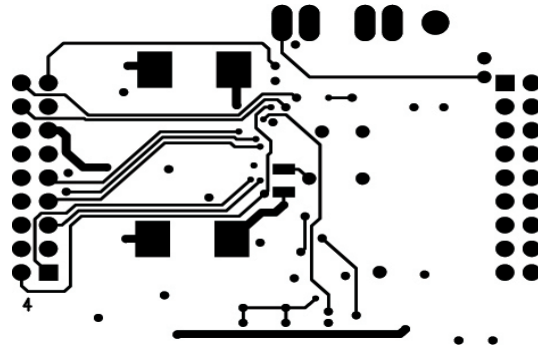

Layer 5

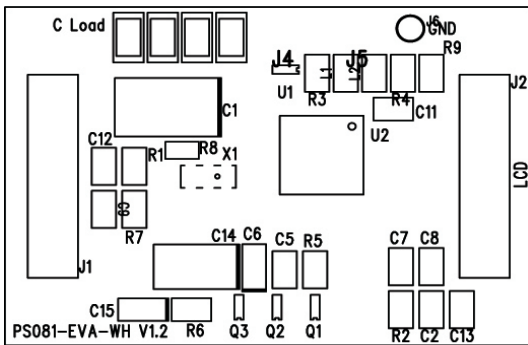

Last Changes:

01.08.09 First edition

15.12.09 Correct description of software installation in chapter 5

