



**Eval Kit Manual**

# **GP30**

**Standard Board**

**GP30-EVA-KIT**

## Content Guide

1	Introduction .....	3
2	Quick Start Guide .....	4
2.1	Install the Software .....	4
2.2	Install the Hardware: .....	4
2.3	Quick Start for Initial Measurements .....	4
3	Hardware Description .....	6
3.1	Introduction .....	6
3.2	Communication Interface .....	6
3.3	External amplifier .....	7
4	Software Description .....	8
4.1	Measurement .....	8
4.1.1	First step with measurement control elements .....	8
4.1.2	Time of Flight Measurement Results .....	9
4.1.3	2-Wire Temperature Measurement Results .....	10
4.2	Ultrasonic Measurement Control .....	11
4.3	Temperature Measurement Control .....	12
4.4	General Control .....	13
4.5	Interfaces .....	14
4.6	Interrupt & Error Handling .....	15
5	Software Menu .....	16
5.1	File .....	16
5.2	Tools .....	16
5.3	Firmware .....	19
5.4	Help .....	22
6	Schematics, Layers and BOM .....	23
7	Ordering & Contact Information .....	28
8	Copyrights & Disclaimer .....	29
9	Revision Information .....	30

## 1 Introduction

The GP30-EVA-KIT is a platform for a quick and easy start-up and evaluation of the TDC-GP30 ultrasonic flow converter (UFC). It supports the QFN40 package, which makes available the full functionality of TDC-GP30. The development kit offers user-friendly configuration and extensive testing of the TDC-GP30, but also the complete assembler environment for programming the device. For a proper use of the evaluation system, we strongly recommend to refer to the latest TDC-GP30 datasheets.

**Figure 1: Kit Content**



Pos.	Item	Comment
1	PICOPROG V3.0	Programmer and interface
2	GP30-EVA MODULE	Based on TDC-GP30 in QFN40 package
3	High density DSUB15 cable	Connecting Evaluation board to programmer
4	USB cable	Connects PicoProg V3.0 to PC

The board shows a patch field close to the GPIO pins where an external amplifier as well as analog switches for gas meter operation can be connected.

Please download the latest software for the kit from

<http://www.acam.de/download-center/ultrasonicflowconverter/>

## 2 Quick Start Guide

This section describes how to quickly set up the GP30-EVA-KIT, establish basic operation and make measurements.

### 2.1 Install the Software

It is crucial to install the software before connecting the evaluation kit to your computer. A default driver loading of your OS may interfere with correct installation.

- Download the latest zipped software installation package to the desired directory.
- Unzip the package to the desired directory.
- Open "setup.exe" from the unzipped directory.
- Follow the instructions on the screen.

### 2.2 Install the Hardware:

- Make sure software is installed correctly before proceeding with this step!
- Connect your computer with the PicoProg V3.0 using USB cable.
- Connect PicoProg V3.0 and the evaluation kit motherboard using the DB15 interfaces
- The green LED on the evaluation kit should be on.
- Connect your spool piece to US\_UP and US\_DOWN

### 2.3 Quick Start for Initial Measurements

From the "Start" menu, go to "All Programs" and then to the "acam" directory. Double click the "GP30\_v1\_5\_3" icon (or newer versions, if available) to begin execution of the evaluation software. The following screen should appear:

Figure 2: Measurement Page

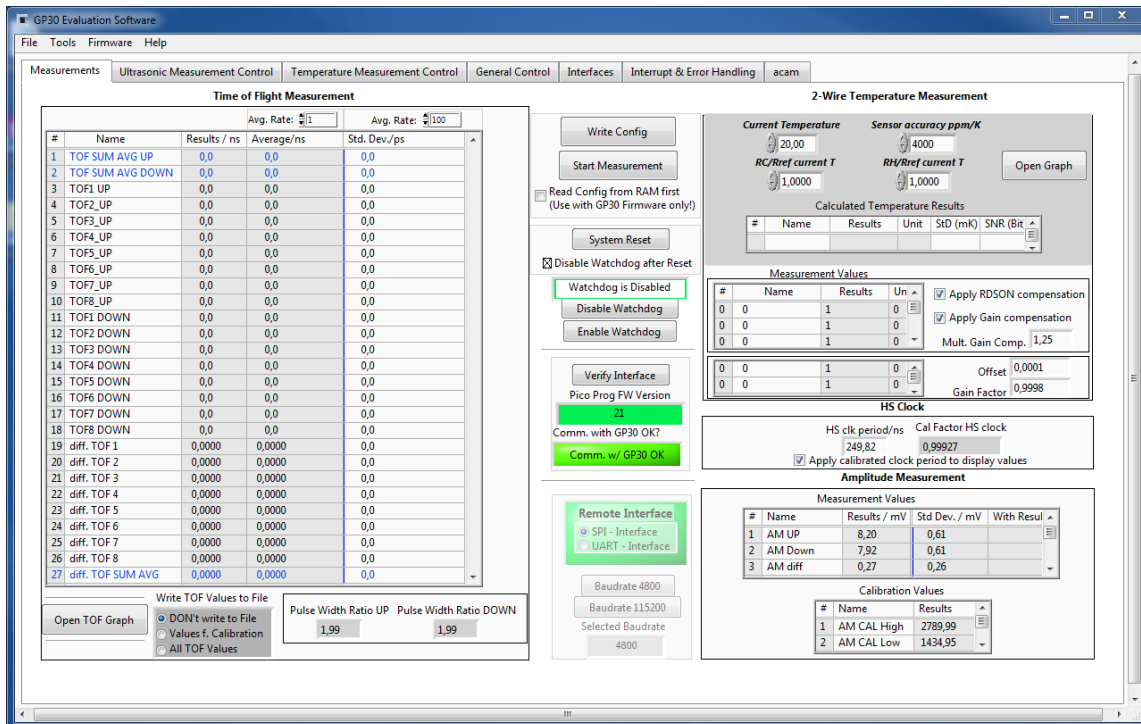

1. Click the “Verify Interface” button to confirm communication between PicoProg V3.0 and TDC-GP30 is working. Both fields, “Pico Prog FW version “ and “Comm. With GP30 OK?” should become green.
2. Next, open our configuration GP30Y\_config\_default\_A1.A2.11.03 and download it into the chip, pressing “Write Config”.
3. Connect your spool piece to pins US\_UP and US\_DOWN.
4. Press “Start Measurement” to begin measuring.

At this point, after successful completion of the above steps, a basic operation of the EVA kit should be possible. The following sections provide a detailed description of the hardware and software for advanced operation.

### 3 Hardware Description

#### 3.1 Introduction

The GP30-EVA MODULE board, shown in figure 3, is the front-end for a water or heat meter. The transducers and temperature sensors can be connected directly to this board. It comes with a 32,768 kHz quartz (X2) and a 4 MHz ceramic oscillator (X1). All ports of TDC-GP30 are available. Additional patch fields allow an easy extension with additional circuits. Those can be amplifiers or analog switches for operation in gas meter mode.

Figure 3: GP30-EVA Board

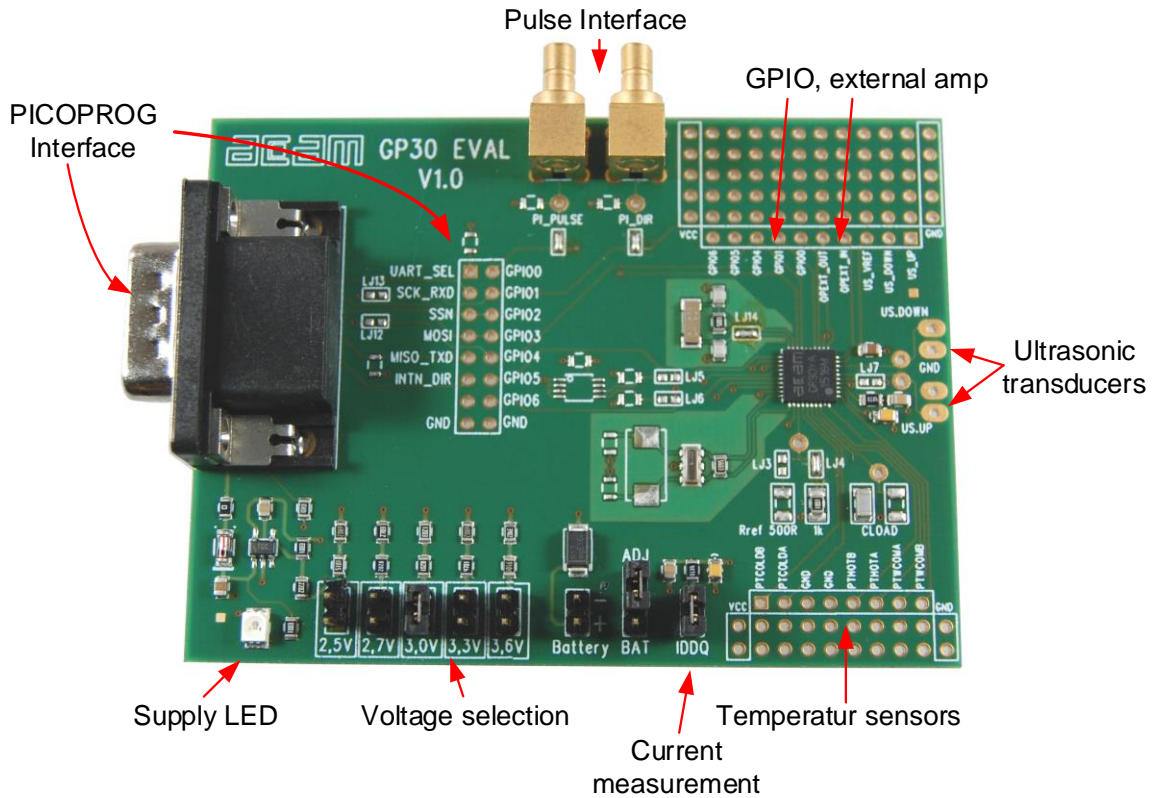

#### 3.2 Communication Interface

The PICOPROG device is a USB-to-SPI converter box that interfaces all UFC evaluation systems. With version 3.0, the PICOPROG also supports the USB-to-UART conversion of TDC-GP30. The PICOPROG is registered by the operating system initially as “picoprogram v3.0 unprogrammed”. As soon as the GP30 evaluation software starts, a special firmware is written into the PICOPROG to handle the SPI or UART communication with the TDC-GP30. The PICOPROG is now listed as “UNIPRO” in the device manager. For SPI communication only, PICOPROG version 2.0 is sufficient.

### 3.3 External amplifier

A typical circuit for an external amplifier at high frequencies (1 to 4 MHz) could be this one:

**Figure 4: External amplifier example**

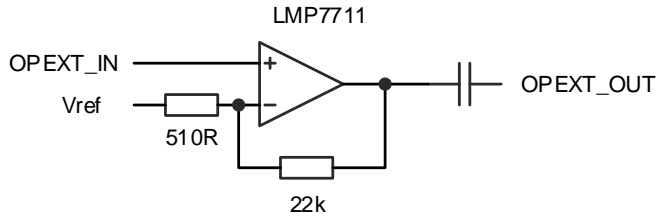

## 4 Software Description

### 4.1 Measurement

When started, the software comes up with the main window, showing the “Measurements” tab.

Figure 5 Main window

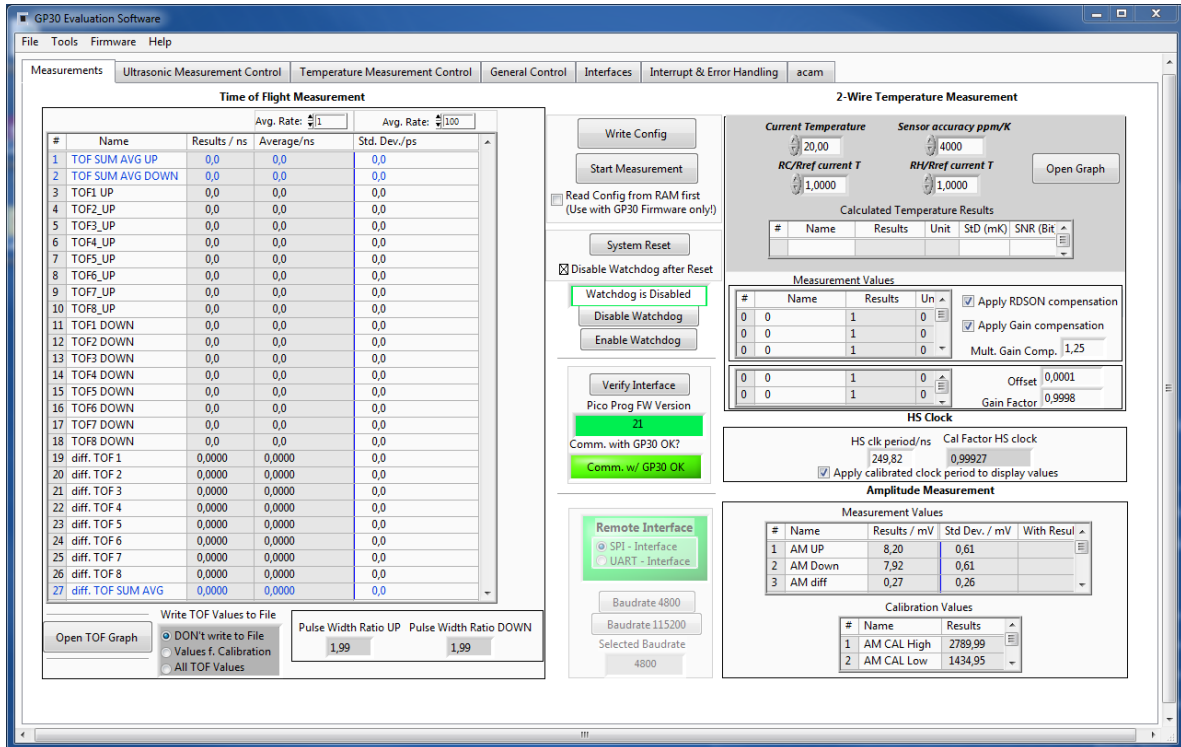

#### 4.1.1 First step with measurement control elements

A good first step is to load a working configuration and make measurements in frontend mode (without using the internal 32-Bit  $\mu$ P). ams provides a sample configuration file named GP30Y\_config\_default\_A1.A2.11.03 which typically works well with DN20 spool pieces.

**Load configuration file:** File menu → Open Config → choose appropriate configuration file

- **Next step:** Press “System Reset” button. Now the PicoProg FW version field should get green and the appropriate version should be displayed (20 or higher). Further, “Comm GP30 OK?” should get green to show that communication with TDC-GP30 works.
- **Next step:** If watchdog is not disabled by “System Reset” button → press “Disable Watchdog” button.
- **Next step:** Press “Write Config” button to download the configuration settings into TDCX-GP30.
- **Next step:** Press “Start measurement” button. Now the chip starts to measure and the software displays the results in the table “Time of Flight Measurements”.

The user can now modify the configuration to fit it to his needs. Having done this, the user can store his own configuration files.



### 4.1.2 Time of Flight Measurement Results

GP30 stores the first 8 hits of every TOF direction separately and also the sum of all measured hits. These 9 results are displayed for both directions, as we call them up and down. The evaluation software additionally calculates the difference between up and down stream, DIFF-TOF. In total, all 27 results are displayed in the “Results” column.

In the “Average” column the user can set the sample size for the averaging (<1000). The software calculates the rolling average of the results accordingly. In “Std. Dev.” column the standard deviation, calculated over a variable sample size, is displayed. The number of samples can be chosen (e.g. 100).

The same is done with the amplitude values of the receiving signals and the pulse width ratio between first hit and start hit. The values for both directions are displayed.

**Note:** The high speed calibration is by default off. This is more convenient when comparing measurement data. But when collecting data for calibration it is strongly recommended to have this active.

**Figure 6 HS Clock calibration**

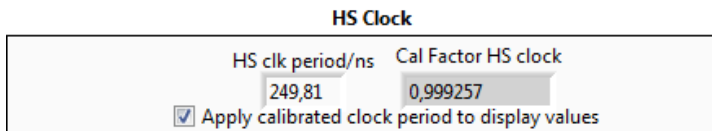

A graph to display TOF measurement results opens in a separate window by pressing “TOF Graph” button

It is possible to activate up to four plots. Each plot has various selections, e.g. TOF1UP, TOF2UP etc.. Always averaged values are displayed.

**Figure 7 TOF Graph**

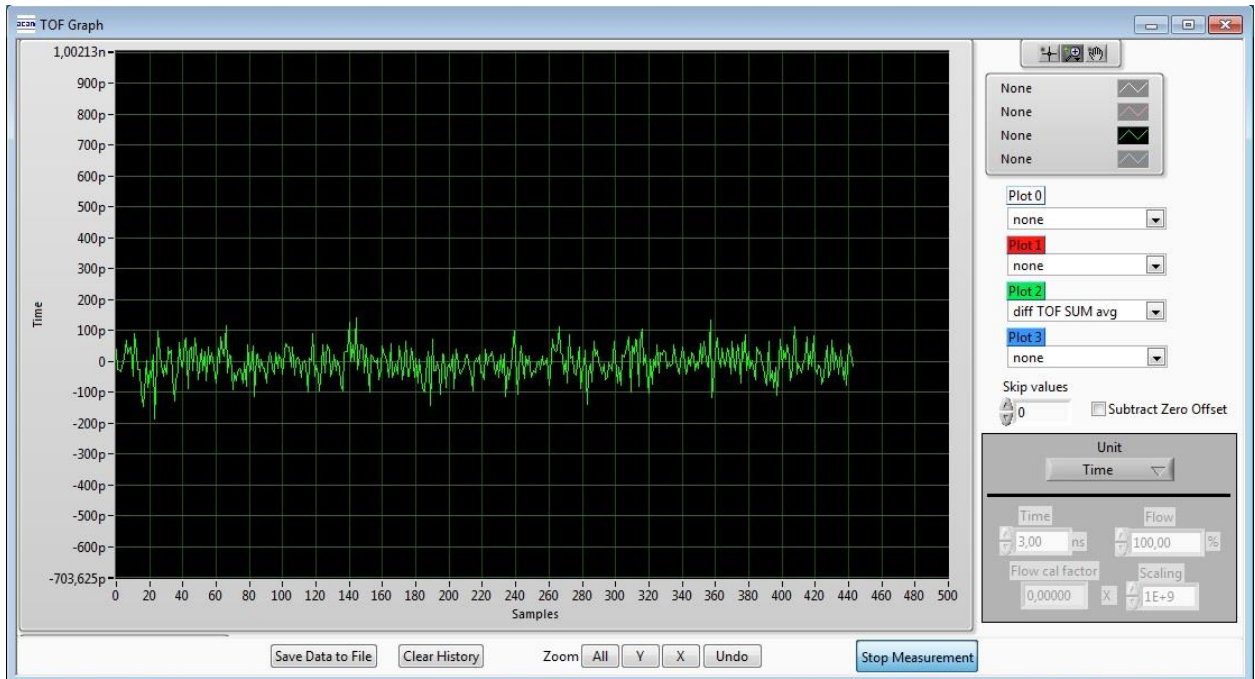

The measurement data can be exported into text files, either the main values for calibration only, or the full data.



## 4.2 Ultrasonic Measurement Control

In this tab the user makes all settings for an appropriate ultrasonic measurement. They group as follows:

- Time of Flight Sequence Control
- Time of Flight Hit Control
- Amplitude Measurement Control
- Transducer Interface Options

Figure 11

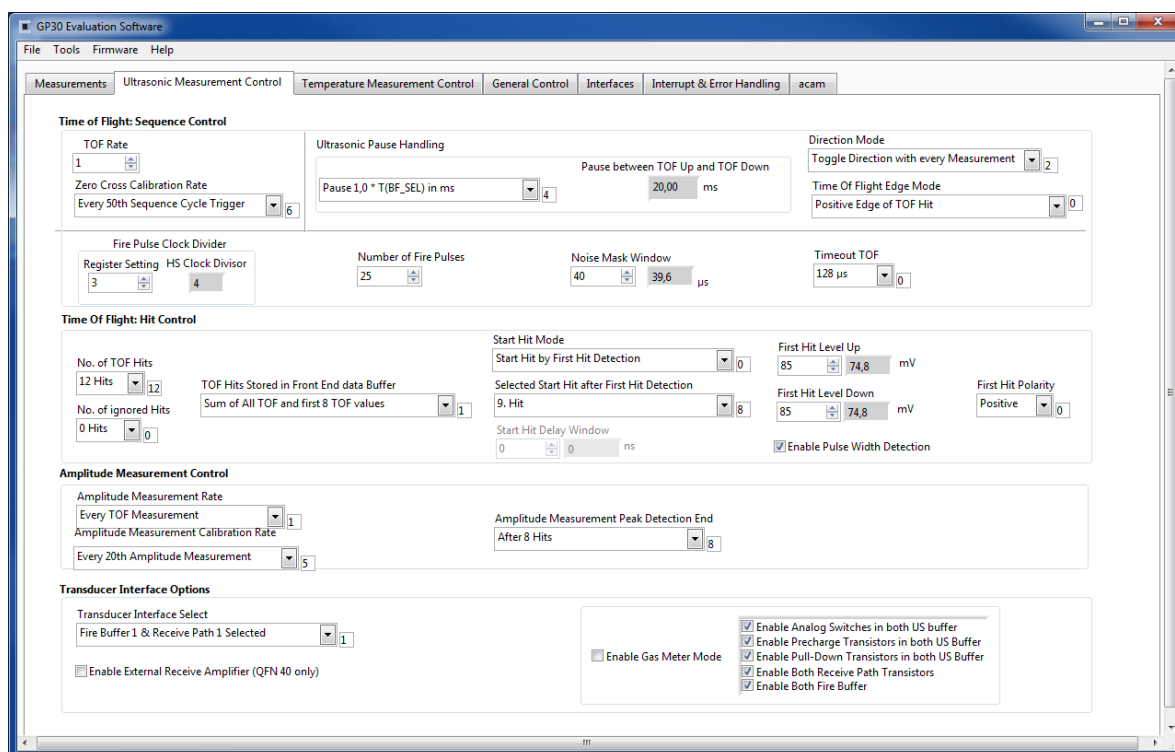

The meanings of the various settings are displayed in clear text. For more details about the register settings please refer to the GP30 manual.

### 4.3 Temperature Measurement Control

All settings for an appropriate temperature measurement are done in this tab, which are grouped as follows:

- Sequence Control
- Measurement Control
- Temperature Measurement Cycle Time

Figure 12

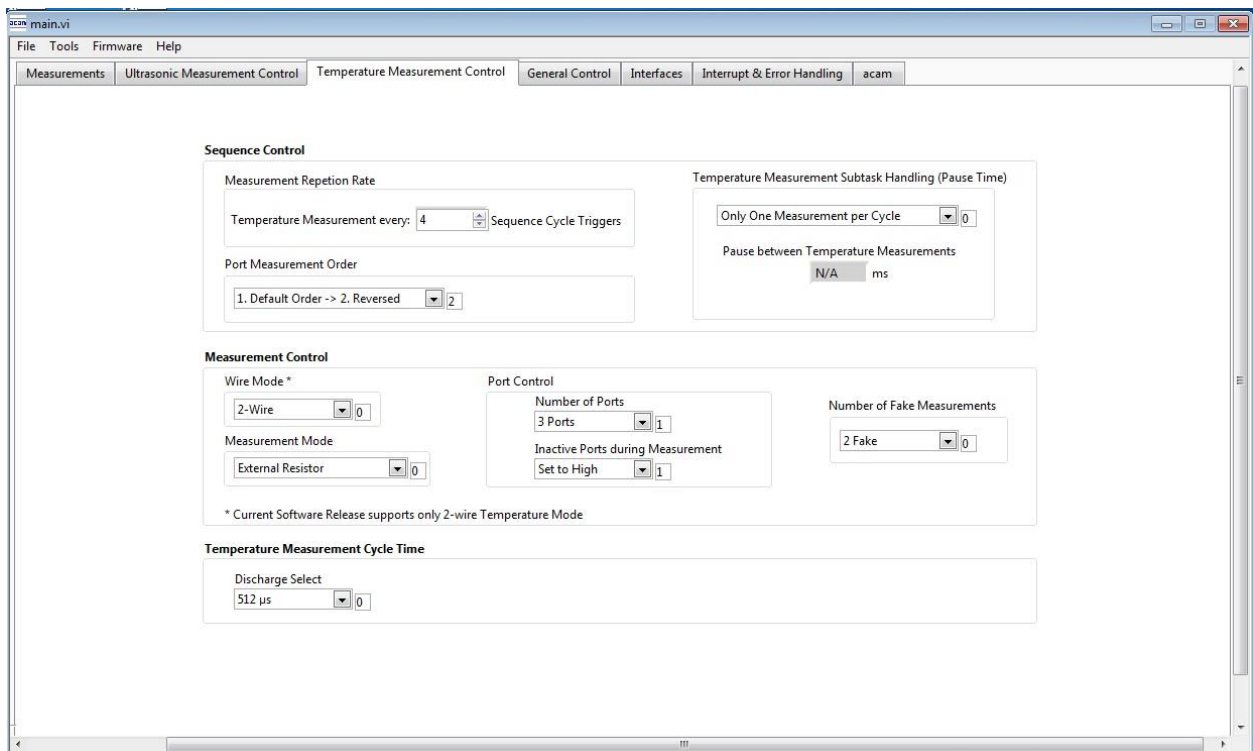

The meanings of the various settings are displayed in clear text. For more details about the register settings please refer to the GP30 manual.

## 4.4 General Control

The “General Control” tab covers configuration settings for

- Task sequencer
- High speed clock control
- Voltage measurement
- CPU handling
- Timer Settings

Figure 13

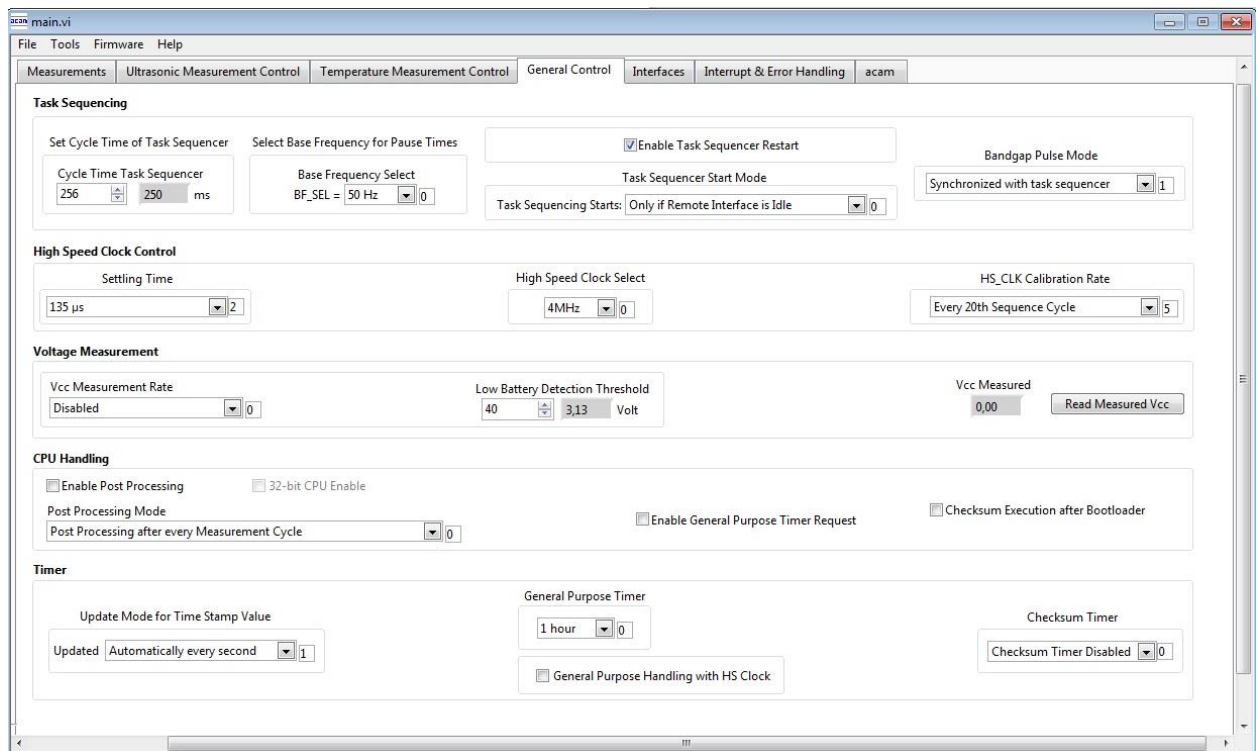

The meanings of the various settings are displayed in clear text. For more details about the register settings please refer to the GP30 manual.

### Firmware

In case the TDC-GP30 has firmware, setting flag “Enable post processing” turns on the CPU (flow meter mode). Having this not set, the GP30 runs as front-end in time conversion mode.

## 4.5 Interfaces

The “Interfaces” tab covers configuration settings for

- Pulse interface including test option
- EEPROM interface
- GPIO Control
- UART remote interface.

Figure 14

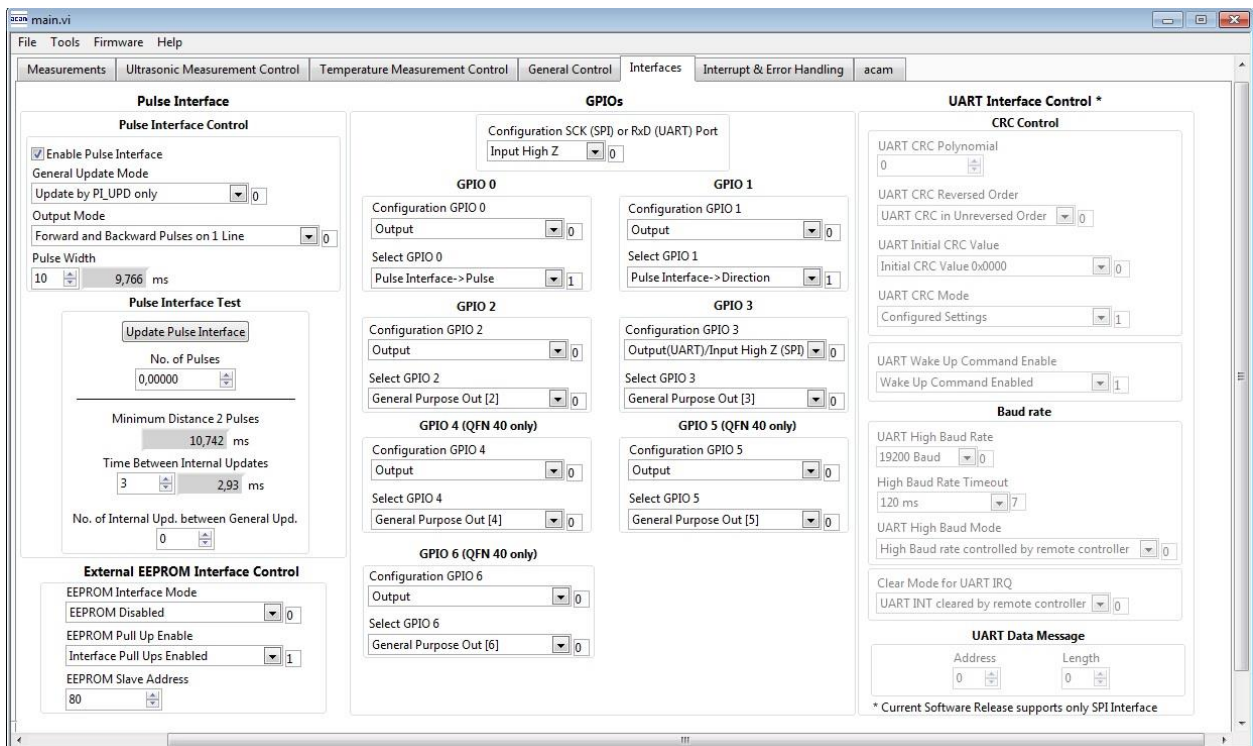

The meanings of the various settings are displayed in clear text. For more details about the register settings please refer to the GP30 manual.

### Pulse Interface

The pulse interface needs an appropriate firmware in the chip. This settings in the evaluation software only generate an artificial pulse to test the general functionality. But it is not related to any measurement.

### UART

The UART is not supported in this software version.

## 4.6 Interrupt & Error Handling

On this tab error indicators and interrupt sources for remote interface can be selected.

Figure 15

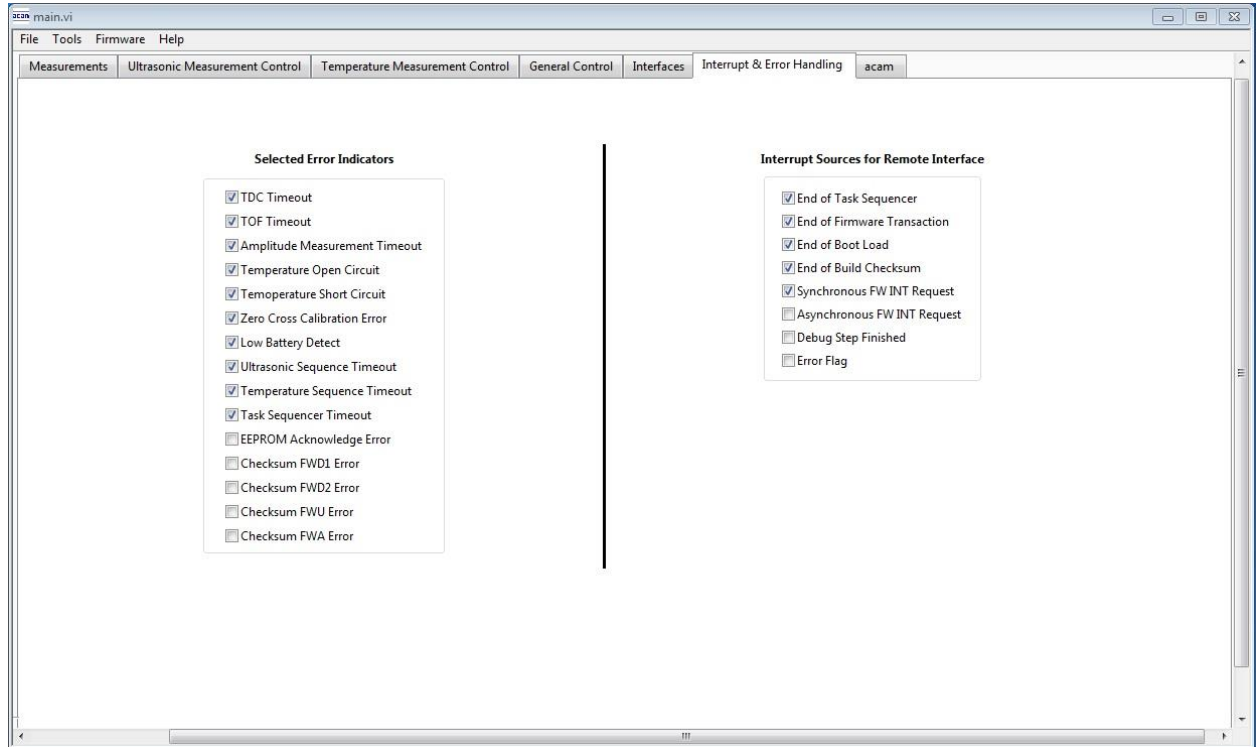

The meanings of the various settings are displayed in clear text. For more details about the register settings please refer to the GP30 manual.

## 5 Software Menu

Beside main window, the software menu allows the opening of other windows. There are some menu items which are redundant to available buttons of main window.

### 5.1 File

- Open Config

This dialog box allows the path selection of a configuration file, covering the register settings, necessary for a proper configuration of the GP30. After opening this file, the control settings are updated in the GUI.

- Save Config

This menu item allows the saving of the current GUI control settings into a configuration file

- Close

Close all open windows of the GP30 Evaluation software.

### 5.2 Tools

- Run Measurement

Same function as “Start/Stop Measurement” button in “Measurement” tab of main window.

- TOF Graph

Same function as “Open TOF Graph” button in “Measurement” tab of main window.

- Temperature Graph

Same function as “Open Graph” button for temperature measurement in “Measurement” tab of main window.

- RAM Memory

**Figure 16**

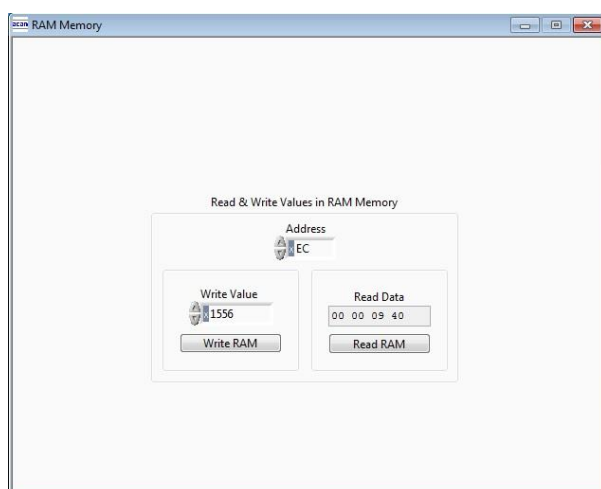

Opens a window which allows single write and read accesses to random access area for addresses 0x000 – 0x0FF.

The random access area from 0x100 – 0x17F, containing the firmware data, can be accessed separately by “Firmware Download” window.



- Registers

Figure 17

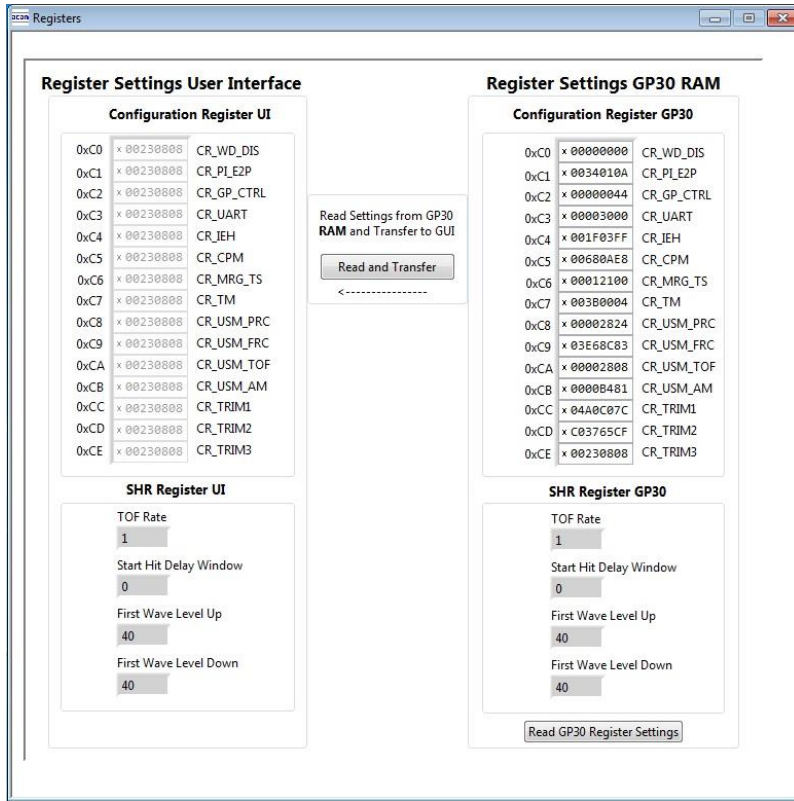

Opens a window which shows the registers important for a proper configuration setting of the GP30. In the left column, the register contents correspond to the settings done in tabs of GUI main window. If the button “Read GP30 Register Settings” is pressed, the configuration settings located in GP30 registers are displayed in the right column,. By pressing “Read and Transfer” button, the register settings in the tabs of main window and in the left column of this window are updated with the register settings from right column.

- Remote Commands

This window summarizes some additional commands which can be executed via remote interface.

- System Reset: Executes a complete system reset of GP30. Same function as “System Reset” button in “Measurement” tab of main window.
- System Init: Same function as “System Reset” without clearing the configuration (CR\_...) and the system handling (SHR\_...) register.

Figure 18

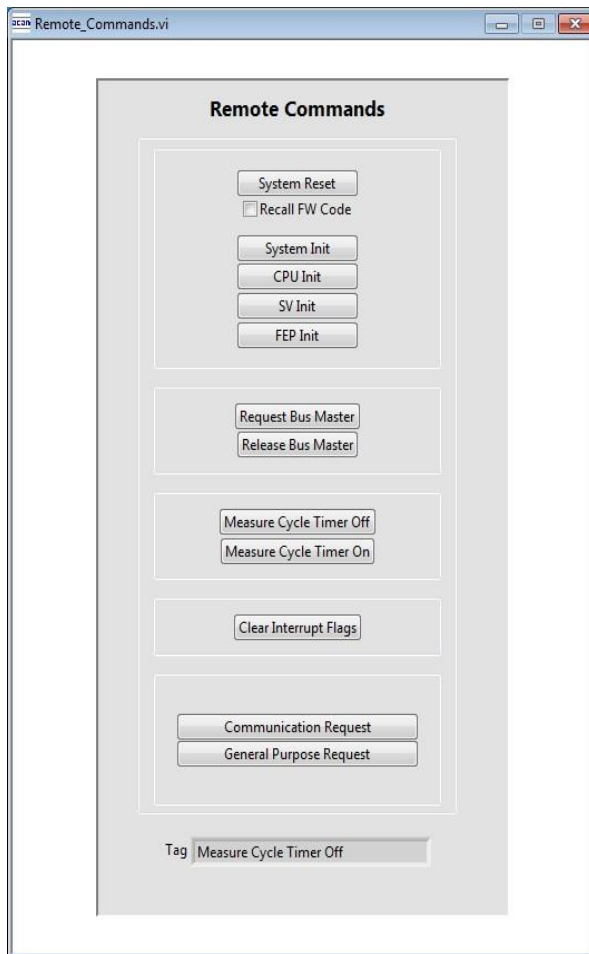

- CPU Init: Clears the CPU block in GP30
- SV Init: Clears the supervisor block in GP30
- FEP Init: Clears the frontend processing block in GP30
- Request/Release Bus Master: Allows the request of the bus master in GP30, e.g. if the random access bus is blocked by a deadlock, caused by an improper firmware download.
- Measure Cycle Timer Off/On: Stop & start of the measure cycle timer.
- Clear Interrupt Flags: Clears all bits in SRR\_IRQ\_FLAG register
- Communication Request: Allows an asynchronous demand by remote controller to get an interrupt by GP30, signaling the time for remote communication
- General Purpose Request: Allows an asynchronous request by remote controller to initiate a general purpose handling in in firmware of integrated GP30 CPU.

### 5.3 Firmware

- Assembler

The TDC-GP30 assembler is integrated into the GP30 evaluation software. It is opened in the Firmware menu of the main program:

Figure 19

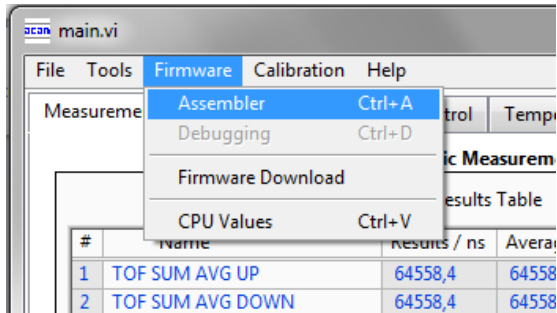

The following window comes up:

Figure 20

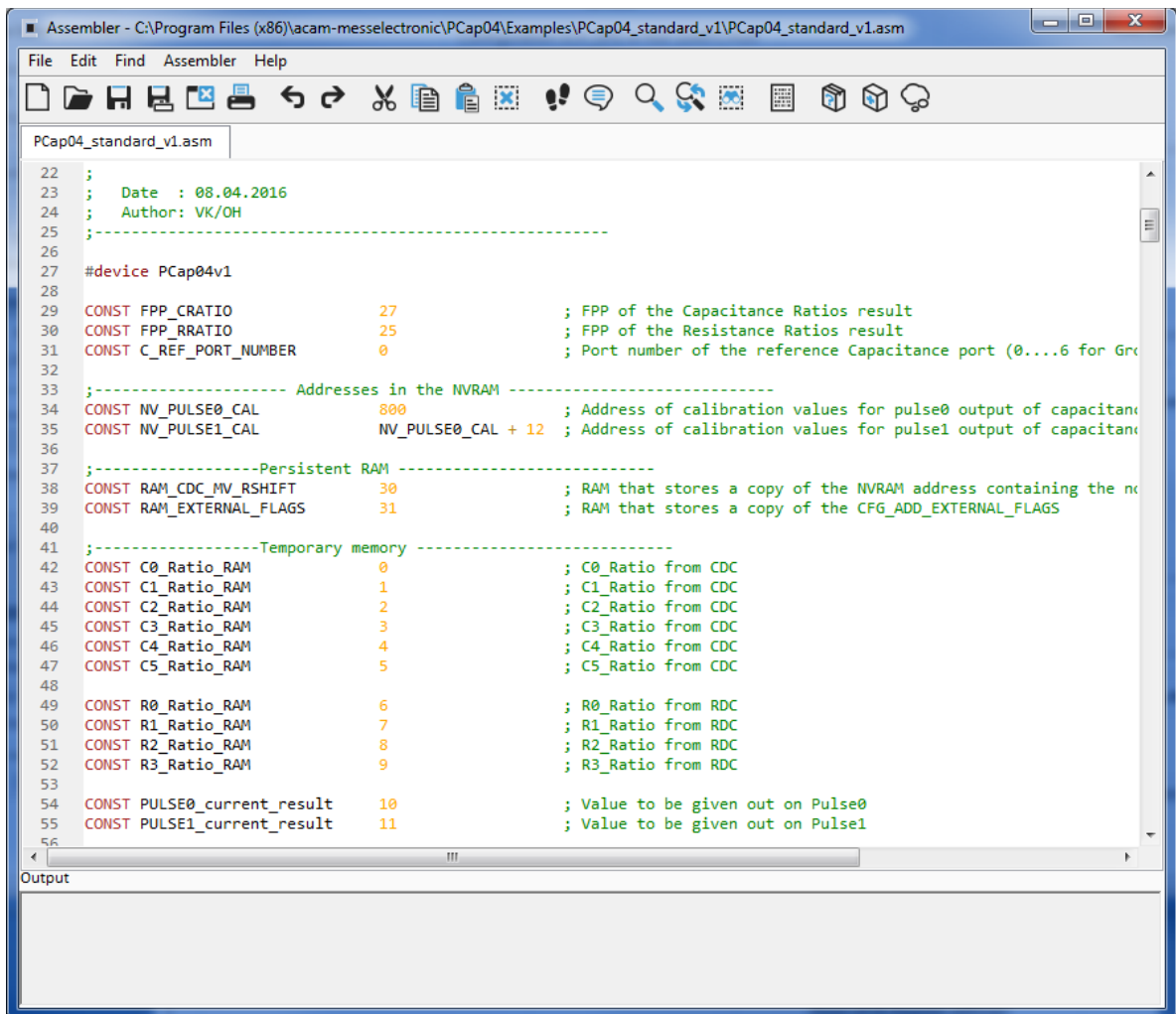

This is a comfortable editor with syntax highlighting, search and replace, copy and paste functions.

Under menu item “Assembler” the user finds the compile and download options. The download option effects, that “Firmware Download” window is opened (see also below).

Whether the call of these functions was successful or not is indicated by the messages at the bottom of the assembler window.

- Download

This window allows the download of the firmware which is typically handled by 2 files, one for the “Firmware User Code” and one for the “Firmware Data”.

Figure 21

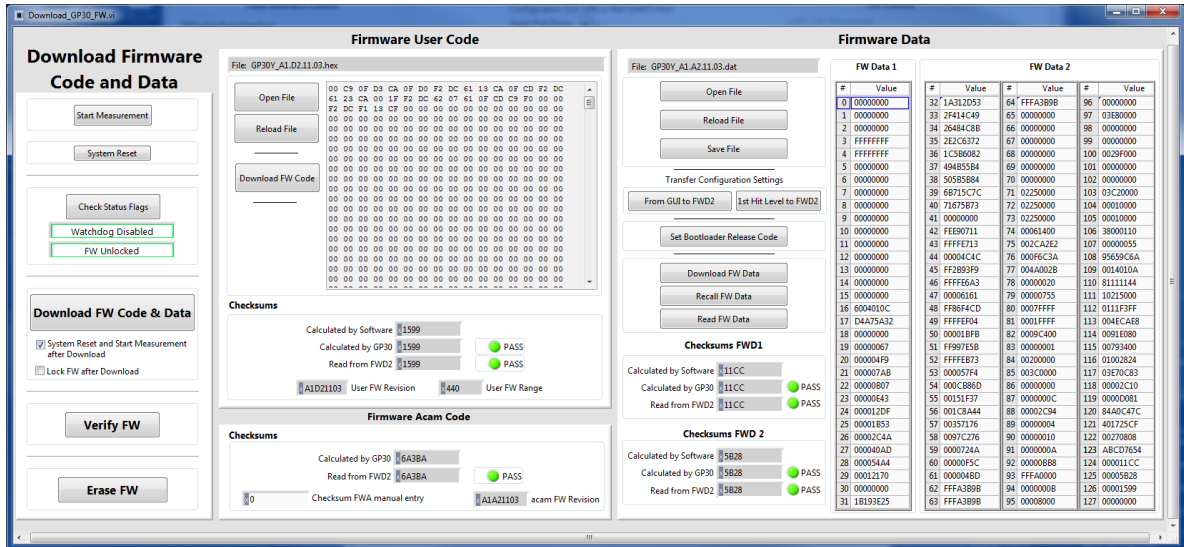

- With “Check Status Flag”, the watchdog and the lock state of the GP30 can be checked. Please make sure that the watchdog is disabled before starting a download or other transactions in this window.
- In the “Firmware User Code” section, a firmware user code file (\*.hex), which is typically generated by the assembler tool and intended for the user part of 4kx8 Program NVRAM, can be loaded by pressing “Open File”.
- In the “Firmware Data” section, a firmware data file (\*.dat), which is intended for the 128x32 Data NVRAM, can be loaded by pressing “Open File”. This section also contains some additional transfer options from GUI to FW Data 2 fields and from GP30 back to FW Data 2 fields.
- By pressing “Download FW Code & Data” both files are stored in the corresponding NVRAMs. This action takes a few seconds. After the download, both files are located in the volatile as well in the non-volatile part of the appropriate NVRAMs. The download can be combined with a lock option of the firmware.
- When pressing “Download FW Code & Data” a possible auto running firmware program is stopped. If a new proper auto running firmware program is downloaded, this firmware can be started again by performing a system reset.

- The last 4 addresses of FW Data 2 section contains the fields for the checksums which are stored to GP30 when downloading firmware to GP30. These fields are directly updated, when firmware files are loaded or contents of firmware data fields are changed.
- If pressing the “Verify FW” button after downloading, the content of the NVRAMs can be compared with the given files by their checksums. The software calculates the checksum of the given files and reads the calculated checksums of GP30 as well as the stored checksums at the end of FWD2 section. Then the checksums of every section are compared to each other. In case of a successful programming all indicators have to be green.
- In the “Firmware Acam Code” section, the checksums for the firmware acam code are also checked and displayed after a “Verify FW”. The firmware acam code cannot be modified by user. Therefore a checksum calculated by software filed is missing in this section.
- A lock state of GP30 or a hang-up, caused by a faulty firmware user code can be dissolved by pressing “Erase FW” button. After that, a new firmware (user code & data) need to be downloaded again.
- CPU Values

**This tab is only for customer who uses the acam firmware for flow calculation.** It reads out some important CPU values like water temperature, flow, velocity, etc. To enable the readout the “Read calculated values” checkbox has to be set.

Figure 22

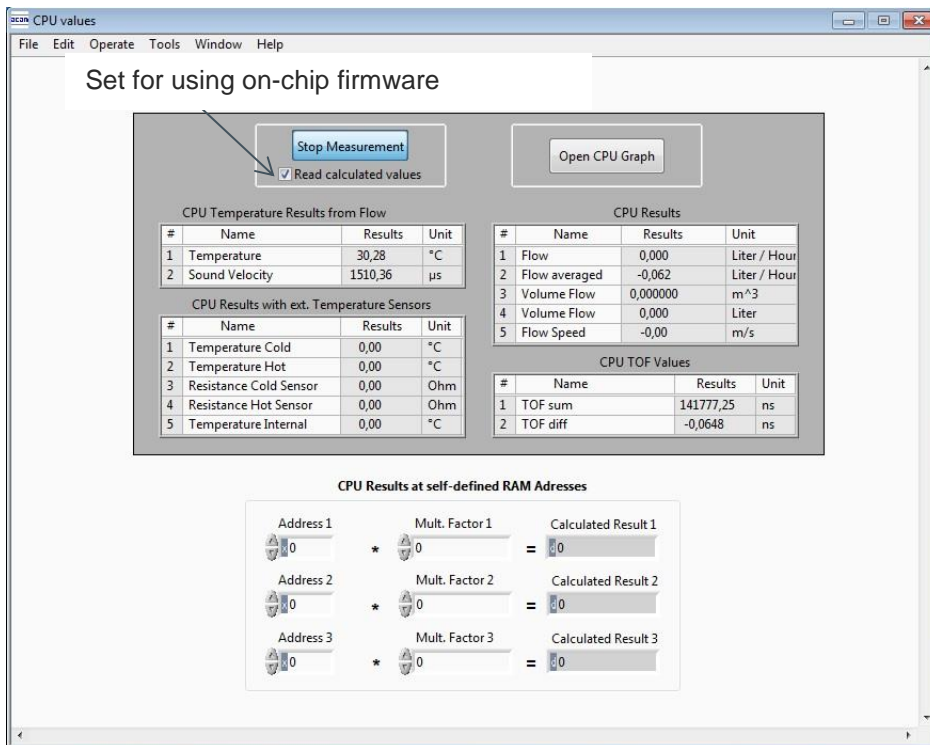

## 5.4 Help

When moving the cursor over the values in tabs of main window, the parameter name (used in the GP30 manual) is displayed. By right-click and selection of “Description and Tip”, a window is opened showing additional description of the value.

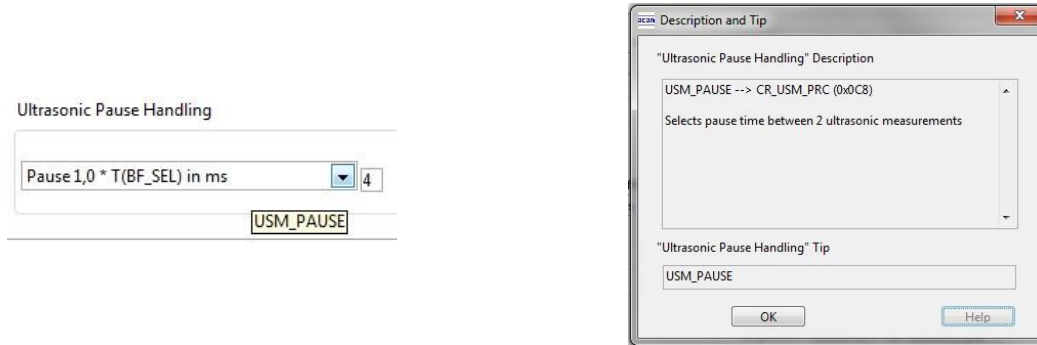

- Help Contents

Not supported in this software revision

- USB Communication

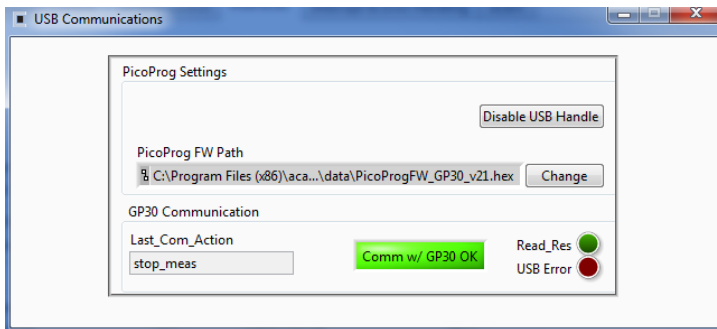

As described in chapter “Software Installation”.

- About

Displays software version number together with general information about software and acam.

## 6 Schematics, Layers and BOM

Figure 23: GP30-EVA MODULE Schematics

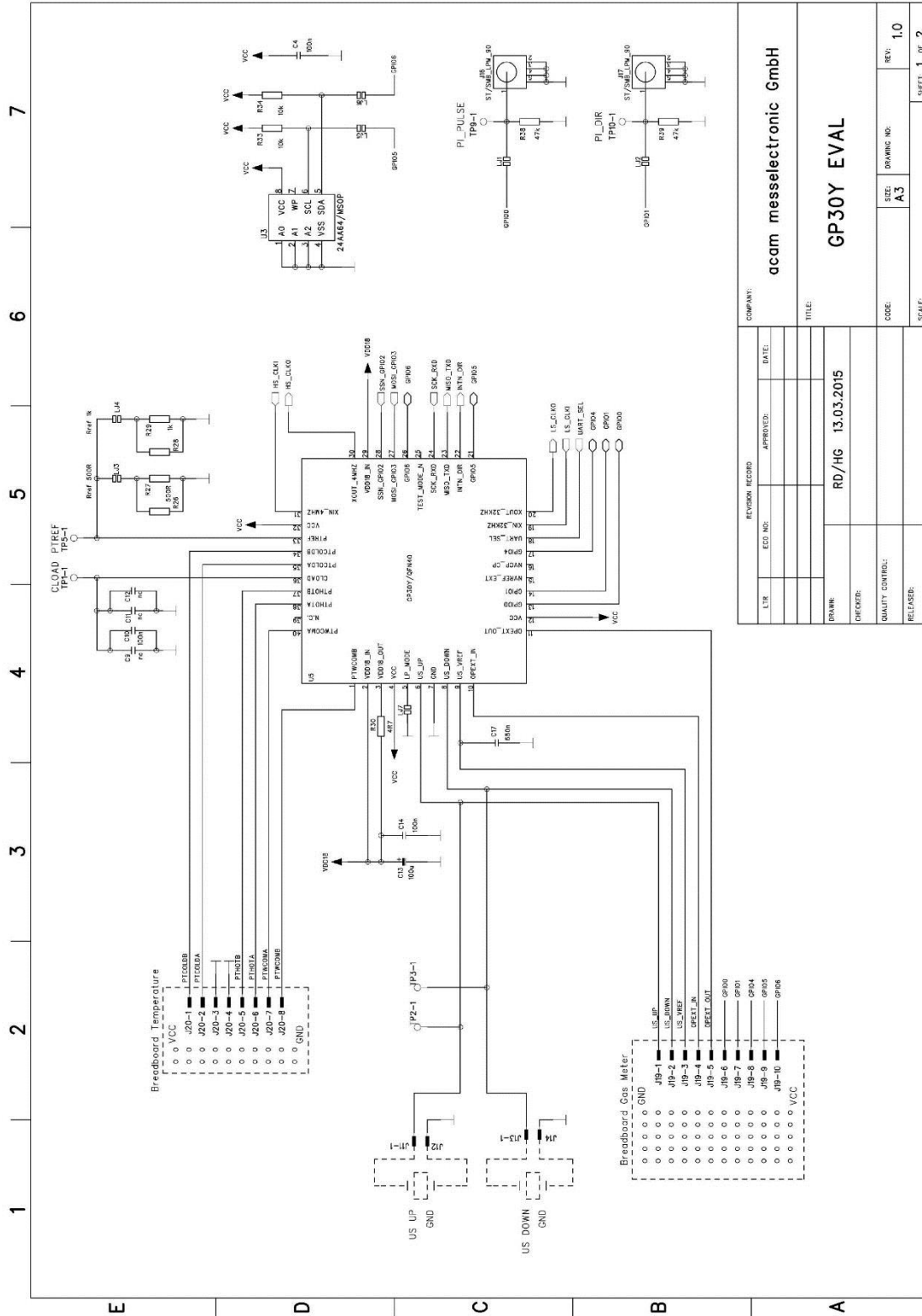

COMPANY:		acam messelectronic GmbH	
REVISION RECORD:		TITLE:	
LTB	ECD NO:	RD/HG	13.03.2015
DATE:	APPROVED:	CODE:	SIZE: A3
		DRAWING NO:	REV: 1.0
		QUALITY CONTROL:	SCALE: SHEET 1 OF 2
		RELEASED:	



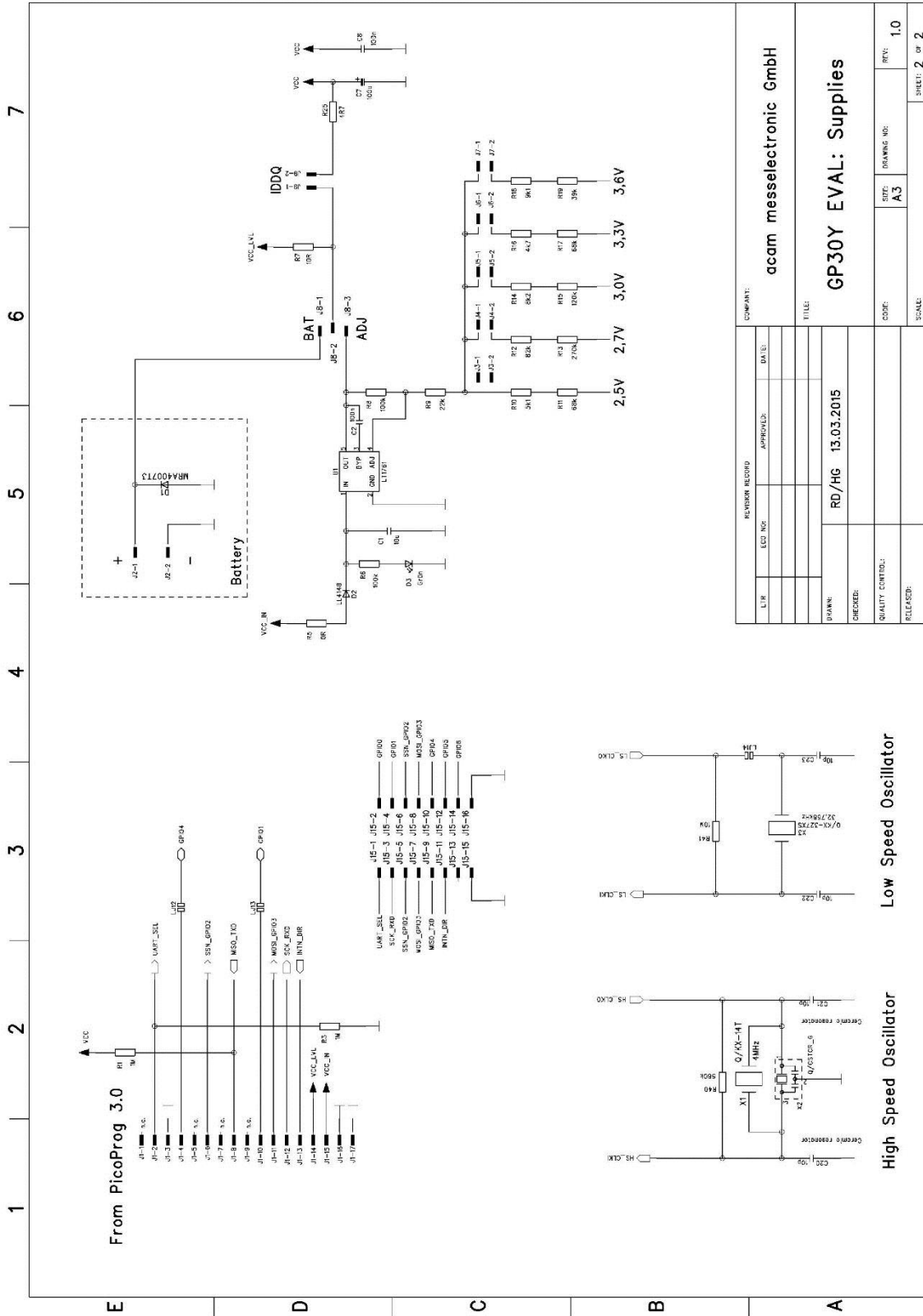

LIT		REVISION RECORD	DATE:
ECC INC		APPROVED:	
DATE:			
COMPANY: <b>acam messeletronic GmbH</b>			
TITLE: <b>GP30Y EVAL: Supplies</b>			
DATE:	REV:	DRAWING NO:	REV:
13.03.2015	A5		1.0
CHECKED:	RELEASED:	SCALE:	SHEET: 2 of 2
QUALITY CONTROL:			

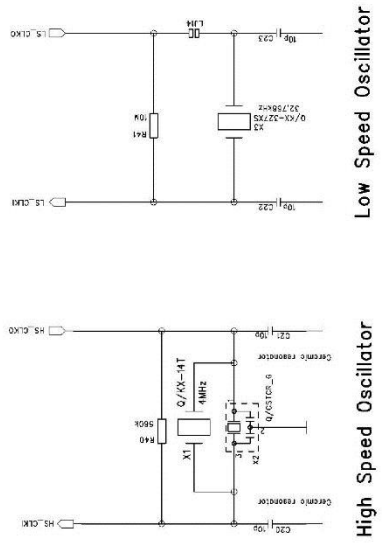
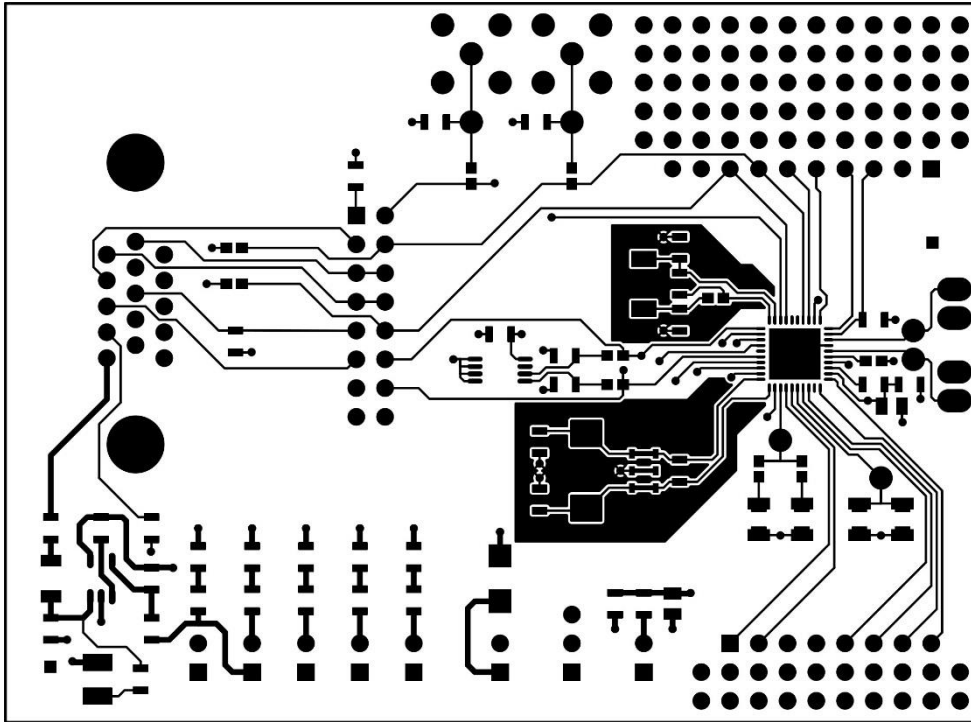
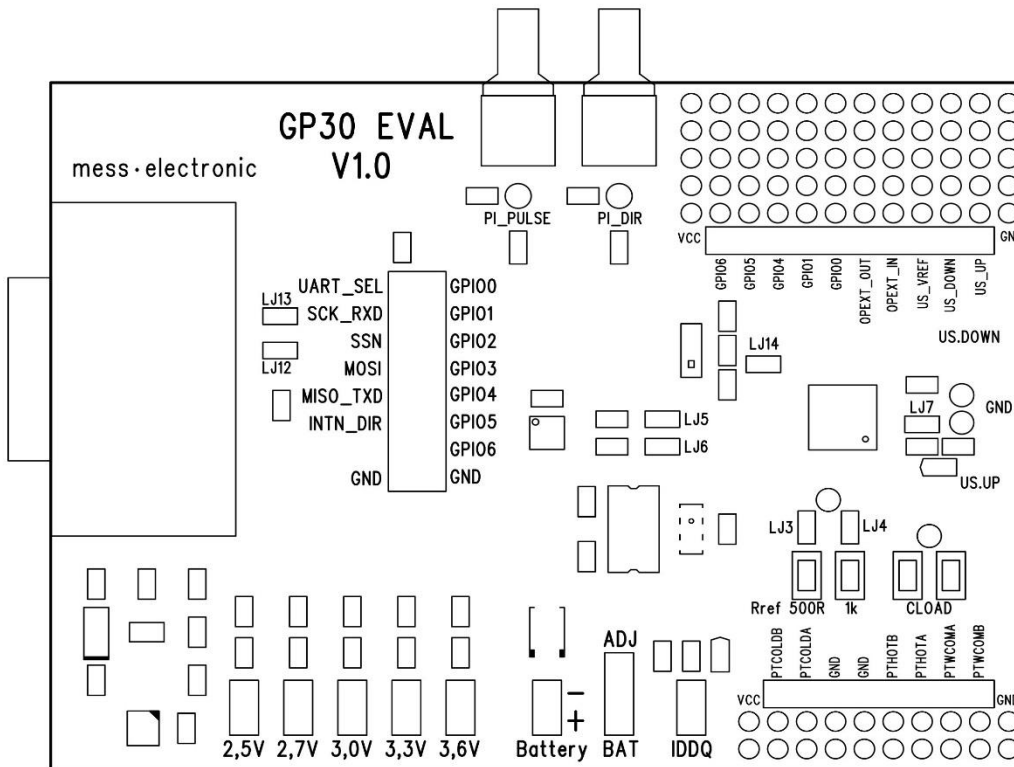



Figure 24: GP30-EVA MODULE Layout



L1



L1

Figure 25: Bill of Materials for GP30-EVA MODULE

Item	Qty	Reference	Part Name	PART DESC	TYPE
1	3	C2 C8 C14	C805,100n	CHIP-CAPACITOR	
2	2	C22 C23	C805,10p	CHIP-CAPACITOR	
3	1	C1	C805,10u	CHIP-CAPACITOR	
4	1	C17	C805,680n	CHIP-CAPACITOR	
5	1	C10	C1206,100n	CHIP-CAPACITOR	GRM31C5C1E104JA01L
6	2	C7 C13	F95_P,100u	TANTAL	F950J107MPAAQ2
7	1	U5	GP30Y/QFN40	TDC GP30Y	
8	1	D3	LED/HSMX-PLCC2,Grün	SURFACE MOUNT LED	
9	1	D2	LL4148	DIODE	
10	1	U1	LT1761	LOW NOISE LDO	LT1761ES5-BYP
11	4	LJ1 LJ2 LJ4 LJ14	L_JUMPER	SOLDER BRIDGE	
12	1	D1	MRA4007T3	DIODE	
13	1	X2	Q/CSTCR_G,4MHz	CERAMIC RESONATOR	CSTCR4M00G53-R0
14	1	X3	Q/KX-327XS,32,768kHz	CRYSTAL QUARTZ	KX-327XS
15	1	R5	R805,0R	CHIP-RESISTOR	
16	2	R25 R30	R805,4R7	CHIP-RESISTOR	
17	1	R7	R805,10R	CHIP-RESISTOR	
18	1	R29	R805,1k	CHIP-RESISTOR	
19	1	R16	R805,4k7	CHIP-RESISTOR	
20	1	R10	R805,5k1	CHIP-RESISTOR	
21	1	R14	R805,8k2	CHIP-RESISTOR	
22	1	R18	R805,9k1	CHIP-RESISTOR	
23	1	R9	R805,22k	CHIP-RESISTOR	
24	1	R19	R805,39k	CHIP-RESISTOR	
25	2	R11 R17	R805,68k	CHIP-RESISTOR	
26	1	R12	R805,82k	CHIP-RESISTOR	
27	2	R6 R8	R805,100k	CHIP-RESISTOR	
28	1	R15	R805,120k	CHIP-RESISTOR	
29	1	R13	R805,270k	CHIP-RESISTOR	
30	1	R40	R805,560k	CHIP-RESISTOR	
31	1	R41	R805,10M	CHIP-RESISTOR	
32	7	J2 J3 J4 J5 J6 J7 J9	ST/254_2	STIFTLISTE 2POL.	

Item	Qty	Reference	Part Name	PART DESC	TYPE
33	1	J8	ST/254_3_1R	STIFTLISTE 3POL.	
34	1	J1	ST/DSUB15HD_ABG	MALE CONNECTOR DSUB15 ABG	
35	2	J16 J17	ST/SMB_LPM_90	SMB CONNECTOR ABG	R114.665.000

## 7 Ordering & Contact Information

Ordering Code	Part Number	Description
GP30-EVA-KIT	220260004	GP30 Eval Kit for QFN40 version including PICOPROG and cables
GP30-EVA MODULE	220260008	GP30 evaluation board for QFN40 version

**Buy our products or get free samples online at:**

[www.ams.com/ICdirect](http://www.ams.com/ICdirect)

**Technical Support is available at:**

[www.ams.com/Technical-Support](http://www.ams.com/Technical-Support)

**Provide feedback about this document at:**

[www.ams.com/Document-Feedback](http://www.ams.com/Document-Feedback)

**For further information and requests, e-mail us at:**

[ams\\_sales@ams.com](mailto:ams_sales@ams.com)

**For sales offices, distributors and representatives, please visit:**

[www.ams.com/contact](http://www.ams.com/contact)

### Headquarters

ams AG

Tobelbaderstrasse 30

8141 Premstaetten

Austria, Europe

Tel: +43 (0) 3136 500 0

Website: [www.ams.com](http://www.ams.com)

## 8 Copyrights & Disclaimer

Copyright ams AG, Tobelbader Strasse 30, 8141 Premstaetten, Austria-Europe. Trademarks Registered. All rights reserved. The material herein may not be reproduced, adapted, merged, translated, stored, or used without the prior written consent of the copyright owner.

Demo Kits, Evaluation Kits and Reference Designs are provided to recipient on an “as is” basis for demonstration and evaluation purposes only and are not considered to be finished end-products intended and fit for general consumer use, commercial applications and applications with special requirements such as but not limited to medical equipment or automotive applications. Demo Kits, Evaluation Kits and Reference Designs have not been tested for compliance with electromagnetic compatibility (EMC) standards and directives, unless otherwise specified. Demo Kits, Evaluation Kits and Reference Designs shall be used by qualified personnel only.

ams AG reserves the right to change functionality and price of Demo Kits, Evaluation Kits and Reference Designs at any time and without notice.

Any express or implied warranties, including, but not limited to the implied warranties of merchantability and fitness for a particular purpose are disclaimed. Any claims and demands and any direct, indirect, incidental, special, exemplary or consequential damages arising from the inadequacy of the provided Demo Kits, Evaluation Kits and Reference Designs or incurred losses of any kind (e.g. loss of use, data or profits or business interruption however caused) as a consequence of their use are excluded.

ams AG shall not be liable to recipient or any third party for any damages, including but not limited to personal injury, property damage, loss of profits, loss of use, interruption of business or indirect, special, incidental or consequential damages, of any kind, in connection with or arising out of the furnishing, performance or use of the technical data herein. No obligation or liability to recipient or any third party shall arise or flow out of ams AG rendering of technical or other services.

## 9 Revision Information

Changes from previous version to current revision 1-00 (2016-Aug-08)	Page
Initial version V1.0	

---

**Note:** Page numbers for the previous version may differ from page numbers in the current revision.  
Correction of typographical errors is not explicitly mentioned.