

## Dome Cover Explosionproof Meter Housings

• Dimensions are nominal internal and listed on the following pages.

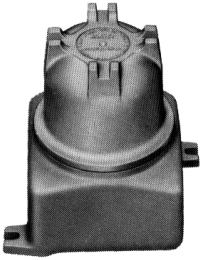

XJLD N4

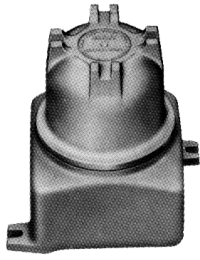

XJTD N4

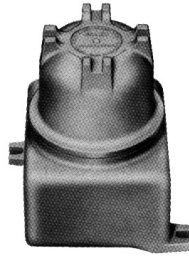

XJHAD N4

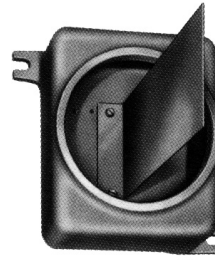

XJHAD N4

Without cover to show optional mounting bracket



XJHCD N4



XJKD N4



XJKAD N4

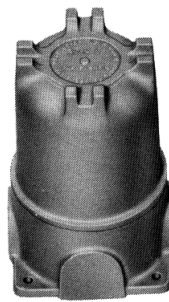

XJWT N4

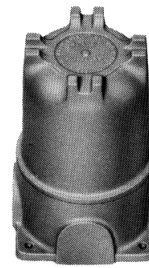

XJWT\_N4

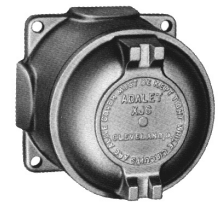

XJSD N4



XJWH N4



XJW N4

To house transfer switch modification (Not UL or CSA)

### CERTIFICATIONS

Class I, Div. 1, Groups C, D  
Class II, Groups E, F, G  
NEMA Type 4



UL 886  
CSA C22.2 No. 25 & 30  
UL 50

# DOMECOVER

## Dome Cover Explosionproof Meter Housings

### STANDARD FEATURES

- This group of housings is designed for enclosing relays, contactors and terminal strips. They are also suitable for accommodating splices of heavy conductors
- When used for splicing, the conductors may be pulled in with the ends extending out beyond the cover opening, making them accessible for splicing. When splices are completed, they need not be crowded back into the body but can be protected with the dome cover assembled to the housing.
- Optional mounting pans available - consult factory

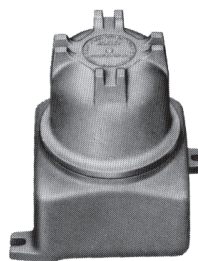

XJLD\_ N4

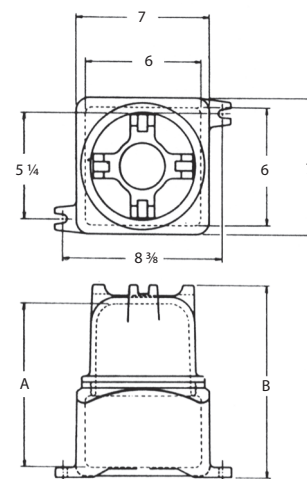

### NOMINAL DIMENSIONS

CAT. NUMBER	CONDUIT SIZE	INSIDE DIM.			INSIDE DOME A	OVERALL HEIGHT	DIA. COVER OPENING	MTNG HOLE SIZE	WEIGHT (LBS)
		W	L	D					
XJLD4 N4	2	6	6	3 1/2	8 9/16	9 13/16	5 3/8	7/16	12
XJLD6 N4	2	6	6	3 1/2	9 7/8	11 1/8	5 3/8	7/16	13
XJLD10 N4	2	6	6	3 1/2	14 3/8	15 5/8	5 3/8	7/16	15
XJLD13 N4	2	6	6	3 1/2	17 3/8	18 5/8	5 3/8	7/16	16
XJTD4 N4	2	5 13/16	6 9/16	4	9	10 1/4	5 3/8	1/2	13 1/2
XJTD6 N4	2	5 13/16	6 9/16	4	10 3/8	11 5/8	5 3/8	1/2	14 1/2
XJTD10 N4	2	5 13/16	6 9/16	4	14 7/8	16 1/8	5 3/8	1/2	16 1/2
XJTD13 N4	2	5 13/16	6 9/16	4	17 7/8	19 1/8	5 3/8	1/2	17 1/2

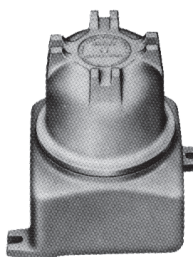

XJTD\_ N4

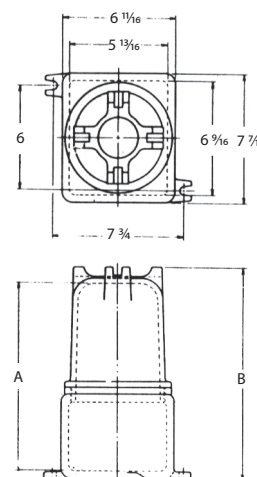

EXPLOSIONPROOF METER HOUSINGS

### CERTIFICATIONS

Class I, Div. 1, Groups C, D  
Class II, Groups E, F, G  
NEMA Type 4



UL 886  
CSA C22.2 No. 25 & 30  
UL 50

# DOME COVER

## Dome Cover Explosionproof Meter Housings

### STANDARD FEATURES

- This group of housings is designed for enclosing relays, contactors and terminal strips. They are also suitable for accommodating splices of heavy conductors.
- When used for splicing, the conductors may be pulled in with the ends extending out beyond the cover opening, making them accessible for splicing.
- When splices are completed, they need not be crowded back into the body but can be protected with the dome cover assembled to the housing.
- Optional mounting pans available - consult factory.

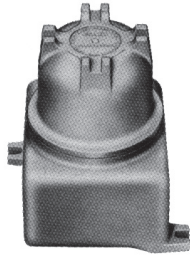
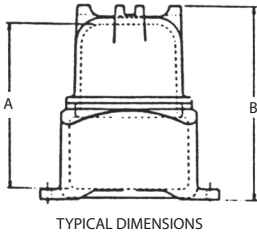

XJHAD\_ N4

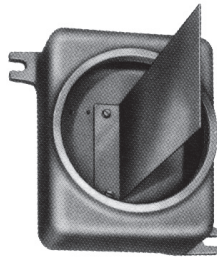

XJHAD N4

Without cover to show optional mounting plate.

### NOMINAL DIMENSIONS

CAT. NUMBER	CONDUIT SIZE	INSIDE DIM.			INSIDE DOME A	OVERALL HEIGHT	DIA. COVER OPENING	MTNG HOLE SIZE	WEIGHT (LBS)
		W	L	D					
XJHAD6 N4	2	7 13/16	9 3/16	4	10 3/4	12 1/4	7	5/16	22 3/4
XJHAD9 N4	2	7 13/16	9 3/16	4	13 3/4	15 1/4	7	5/16	25 1/4
XJHAD12 N4	2	7 13/16	9 3/16	4	16 3/4	18 1/4	7	5/16	28
XJHCD6 N4	2	7 3/4	10 5/16	5	11 3/4	13 1/4	7	5/16	24
XJHCD9 N4	2	7 3/4	10 5/16	5	14 3/4	16 1/4	7	5/16	26
XJHCD12 N4	2	7 3/4	10 5/16	5	17 3/4	19 1/4	7	5/16	30

EXPLOSIONPROOF  
METER HOUSINGS

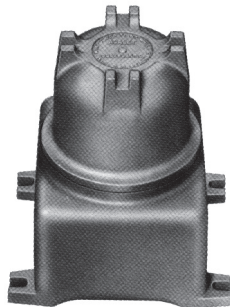
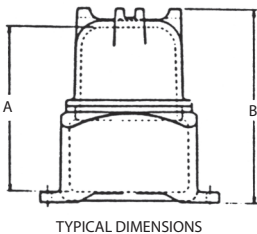

XJHCD\_ N4

### CERTIFICATIONS



Class I, Div. 1, Groups C, D  
Class II, Groups E, F, G  
NEMA Type 4

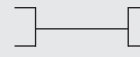

UL 886  
CSA C22.2 No. 25 & 30  
UL 50

# DOMED COVER

## Dome Cover Explosionproof Meter Housings

### STANDARD FEATURES

- This group of housings is designed for enclosing relays, contactors and terminal strips. They are also suitable for accommodating splices of heavy conductors.
- When used for splicing, the conductors may be pulled in with the ends extending out beyond the cover opening, making them accessible for splicing.
- When splices are completed, they need not be crowded back into the body but can be protected with the dome cover assembled to the housing.
- Optional mounting pans available - consult factory.

### NOMINAL DIMENSIONS

CAT. NUMBER	CONDUIT SIZE	INSIDE DIM.			INSIDE DOME A	OVERALL HEIGHT B	DIA. COVER OPENING	MTNG HOLE SIZE	WEIGHT (LBS)
		W	L	D					
XJKD6 N4	4	9 1/2	11 1/2	6 1/8	13	14 3/4	9	1/16	47 1/2
XJKD12 N4	4	9 1/2	11 1/2	6 1/8	19	20 3/4	9	1/16	53 1/4
XJKD18 N4	4	9 1/2	11 1/2	6 1/8	25	26 3/4	9	1/16	60
XJKAD6 N4	4	9 1/2	11 1/2	8 1/8	15	16 3/4	9	1/16	51
XJKAD12 N4	4	9 1/2	11 1/2	8 1/8	21	22 3/4	9	1/16	57
XJKAD18 N4	4	9 1/2	11 1/2	8 1/8	27	29 3/4	9	1/16	64

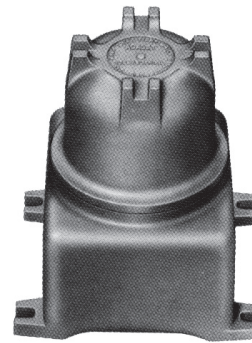

XJKD\_ N4

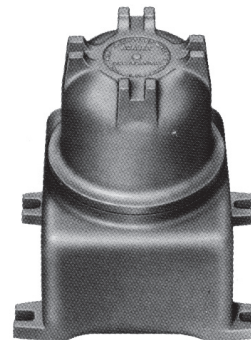
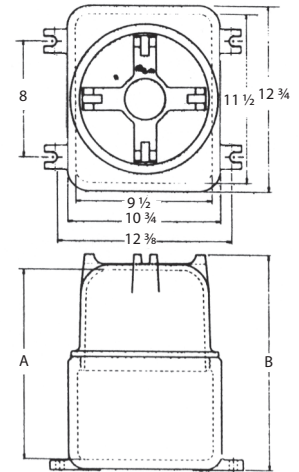

XJKAD\_ N4

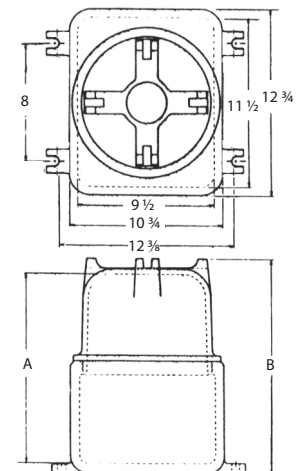

### CERTIFICATIONS

Class I, Div. 1, Groups C, D  
Class II, Groups E, F, G  
NEMA Type 4

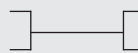

UL LISTED  
CSA C22.2 No. 25 & 30  
UL 50

# DOME COVER

## Dome Cover Explosionproof Meter Housings

### STANDARD FEATURES

- This group of housings is designed for splicing conductors. The dome cover allows the conductors to be pulled in and leave the ends extended for easy splicing.
- When splices are completed, they need not be crowed back into the body but can be protected with the dome cover assembled to the housing.
- These housings are also suitable for mounting transfer switches and other equipment for panel mounted applications
- The housings are available in two (2) body sizes with varying dome cover lengths. The housings have four (4) external pads located 90° apart and have a boss on the inside center of back. (Except for XJSD)
- The pads can be drilled and tapped for holes as listed below

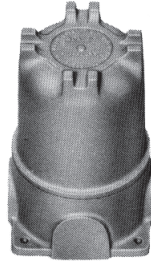
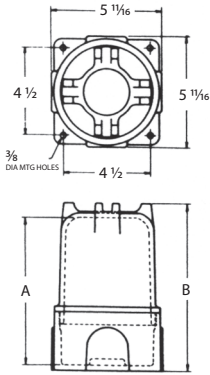

XJW\_ N4

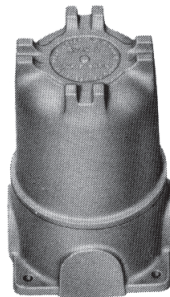
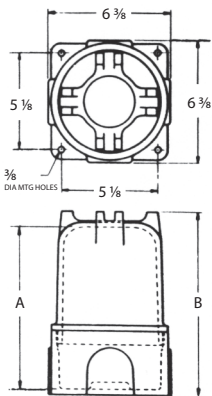

XJWT\_ N4

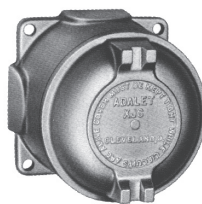
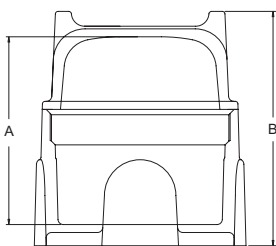

XJSD N4

### NOMINAL DIMENSIONS

CAT. NUMBER	CONDUIT SIZE	INSIDE DIM. DIA.	INSIDE DIM. D	INSIDE DOME A	OVERALL HEIGHT B	DIA. COVER OPENING	MTNG HOLE SIZE	WEIGHT (LBS)
XJW3 N4	1 1/4	4 13/16	2 3/4	5 5/8	6 5/8	4 13/16	5/16	4 3/4
XJW5 N4	1 1/4	4 13/16	2 3/4	7 5/8	8 5/8	4 13/16	5/16	5 3/4
XJWT4 N4	2	5 3/8	3 3/4	7 7/8	8 3/8	5 3/8	3/8	6 3/4
XJWT6 N4	2	5 3/8	3 3/4	9 7/8	10 7/8	5 3/8	3/8	7
XJWT10 N4	2	5 3/8	3 3/4	13 7/8	14 7/8	5 3/8	3/8	8
XJWT13 N4	2	5 3/8	3 3/4	16 7/8	17 7/8	5 3/8	3/8	9
XJSD N4	1	4	3 23/32	4 7/16	5 5/16	4	5/16	3

EXPLOSIONPROOF  
METER HOUSINGS

### CERTIFICATIONS

Class I, Div. 1, Groups C, D  
Class II, Groups E, F, G  
NEMA Type 4

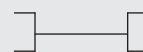

UL LISTED  
UL 886  
CSA C22.2 No. 25 & 30  
UL 50



# DOMECOVER

## Dome Cover Explosionproof Meter Housings

### STANDARD FEATURES

- This housing is designed for splicing conductors. The dome cover allows the conductors to be pulled in and leave the ends extended for easy splicing.
- When splices are completed, they need not be crowed back into the body but can be protected with the dome cover assembled to the housing.
- These housings are also suitable for mounting transfer switches and other equipment for panel mounted applications
- The housings have four (4) external pads located 90° apart and have a boss on the inside center of back
- The pads can be drilled and tapped for holes as listed below

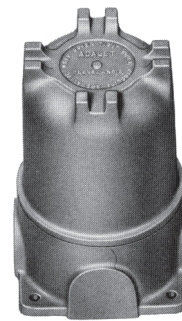

XJWH \_ N4

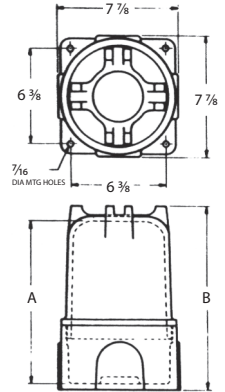

### NOMINAL DIMENSIONS

CAT. NUMBER	CONDUIT SIZE	INSIDE DIM. DIA	INSIDE DIM. D	INSIDE DOME A	OVERALL HEIGHT B	COVER OPENING DIA.	MTNG HOLE SIZE	WEIGHT (LBS)
XJWH6 N4	2 1/2	6 7/8	4 1/4	10 1/4	11 7/16	6 7/8	7/16	15
XJWH9 N4	2 1/2	6 7/8	4 1/4	13 1/4	14 7/16	6 7/8	7/16	17
XJWH12 N4	2 1/2	6 7/8	4 1/4	16 1/4	17 7/16	6 7/8	7/16	19

EXPLOSIONPROOF  
METER HOUSINGS

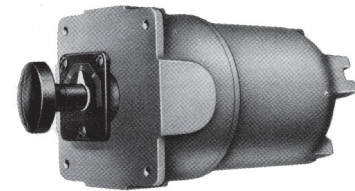

XJW N4

Modified to house transfer switch  
Not UL or CSA

### CERTIFICATIONS

Class I, Div. 1, Groups C, D  
Class II, Groups E, F, G  
NEMA Type 4

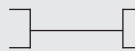

UL 886  
CSA C22.2 No. 25 & 30  
UL 50