

XDHI (Mini) SERIES

2-5/16" ID Enclosure Double Ended Housing

STANDARD FEATURES

- 1/2" NPT conduit feed-through hubs, offset into power side for maximum clearance and capacity
- Front boss with 1/2" NPT opening into instrument side for conduit, sensor or probe (see design options for other sizes)
- Internal and external ground screws and tamper resistant cover set screws for extra safety
- Choice of solid covers or 1-13/16" diameter tempered glass window for local read out and display
- Buna-Nitrile rubber gasket for NEMA Type 4X watertight applications
- Corrosion resistant, "safety blue" polyester powder coating (other colors available)
- Stainless steel hardware



DESIGN OPTIONS

- 1/4"-20 UNC holes in front boss for bracket mounting
- Front boss modifications: 3/4" NPT & various NPSM & metric entries available in place of standard 1/2" NPT (consult factory)
- 2 point, power side terminal strip with sealed pass-through to instrument (add suffix "2T" to catalog number)
- Powder or epoxy coatings to match company color scheme
- Cast-on logos
- Custom drilling & tapping modifications
- Interior bulkhead penetrations
- Power side (shallow side) cover options:

| | | |
|------------|---|----------------|
| Flat Solid | — | Standard |
| Dome Glass | — | Add Suffix "A" |
| Flat Glass | — | Add Suffix "B" |
| Dome Solid | — | Add Suffix "C" |

XDHI - DOMESTIC RATINGS:

DIVISION RATINGS:

CLASSIFIED
CLASS I, DIV 1 GROUP BCD
CLASS II, DIV 1 GROUPS EFG
TYPE 4X



UL1203; CSA C22.2 No. 30 & CSA C22.2 No. 25

XDHI - GLOBAL RATINGS (OPTIONAL):

ZONE RATINGS:

ATEX (FLAMEPROOF – DEMKO)

II 2G  Ex d IIB+H₂

II 2D  Ex tD A20

IP66

IECEX (FLAMEPROOF – UL)

Ex d IIB+H₂

IP66

EN60079-0, EN60079-1

EN61241-0 & EN61241-1

EN60529

IEC60079-0 & IEC60079-1

IEC60529

NOTE: AN EXTENDED TEMPERATURE RANGE APPLIES TO ATEX AND IECEX RATINGS ONLY (-50° C TO +85° C AMBIENT)

The ADALET Engineering Department is Available to Assist you in the Selection of Enclosures and Accessories.

XDHI (Mini) SERIES

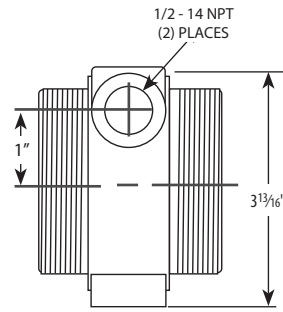
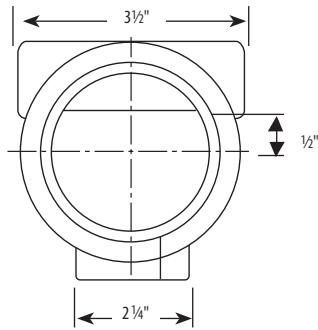

Solid Cover Arrangements

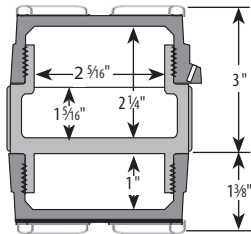

| SOLID COVER | |
|----------------|---------------------------|
| Catalog Number | Description |
| XDHIFCX | Flat Cover, 1/2" NPT Hubs |

Glass Cover Arrangements

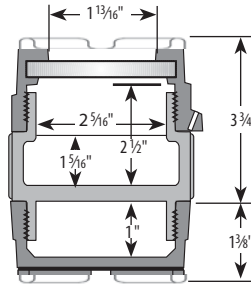

| GLASS COVER | |
|----------------|---------------------------------|
| Catalog Number | Description |
| XDHIFGCX | Flat Glass Cover, 1/2" NPT Hubs |

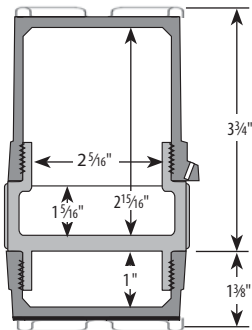

| SOLID COVER | |
|----------------|---------------------------|
| Catalog Number | Description |
| XDHIDCX | Dome Cover, 1/2" NPT Hubs |

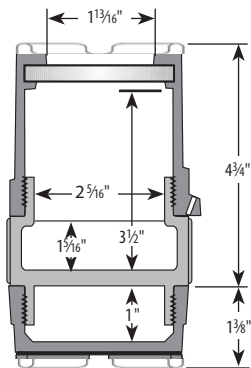

| GLASS COVER | |
|----------------|---------------------------------|
| Catalog Number | Description |
| XDHIDGCX | Dome Glass Cover, 1/2" NPT Hubs |