

FUJI COMMAND SWITCHES REPLACEMENT MANUAL

R series AR30, DR30

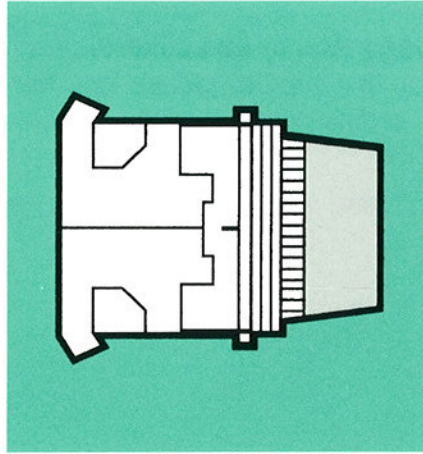

30mm dia.
1¹³/₆₄ inch

**Illuminated
Pushbutton
Switches**

**Pushbutton
Switches**

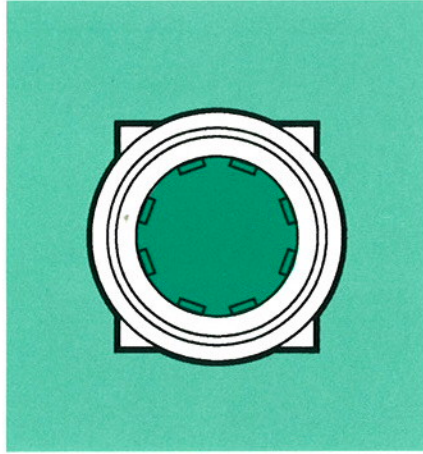
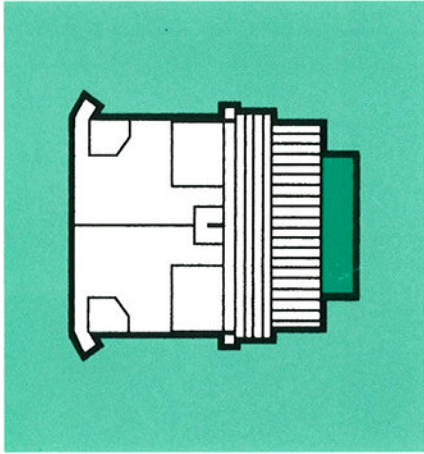
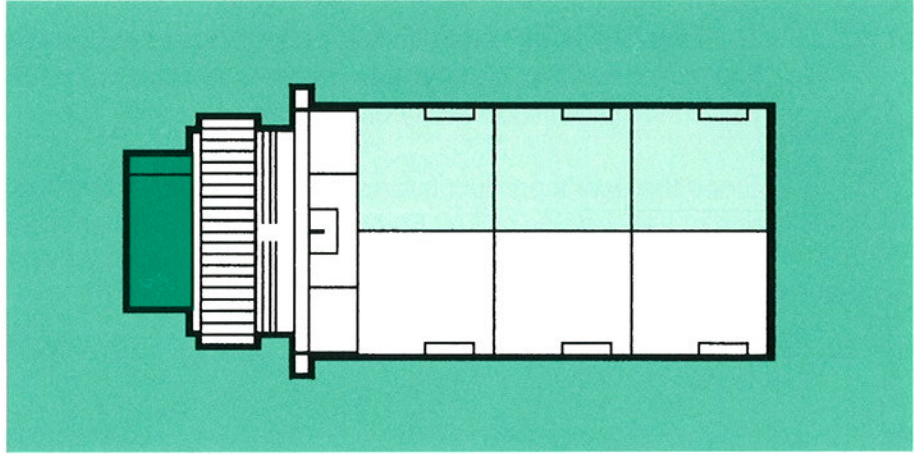

**Selector
Switches**

**Pilot
Lights**

COLOR BUTTON AND CONTACT BLOCK REPLACEMENT PROCEDURE

The procedure should be performed by an authorized Fuji distributor only. If you have any questions on this manual, please feel free to contact either FEEOA (Fuji Electric Corp. of America) or Fuji Electric Co., Ltd. in Japan.

CATALOG DISCLAIMER

The information contained in this catalog does not constitute an express or implied warranty of quality. Any warranty of merchantability or fitness for a particular purpose is hereby disclaimed.

Since the user's product information, specific use application, and conditions of use are all outside of Fuji Electric's control, it shall be the responsibility of the user to determine the suitability of any of the products mentioned for the user's specific application.

COMPONENT PARTS

Illuminated pushbutton switch and pushbutton switch Page 4

Selector switch and pilot light 5

REPLACING OPERATOR / INDICATOR

AR30E0L, E5L, G3L, G8L 6

AR30F0R, F5R, E0R, E5R, G1R, G6R, G0R, S1R, S2R, S3R, S6R 8

AR30M0R, M5R, M3R, M4R 10

AR30Q2R 12

AR30PL 14

AR30PR, PCR, WR 16

DR30D0L, K0L 18

DR30E3L 20

REPLACING CONTACT BLOCKS 22

CONTACT BLOCK ARRANGEMENT 23



Type	Replacing operator / indicator	Replacing contact block	Contact block arrangement
Illuminated pushbuttons, pushbuttons and selector switches			
AR30E0L Illuminated, extended round head	Page 6	Page 22	Page 23, 24, 25
AR30E0R Extended round head	8	22	26, 27
AR30E5L Illuminated, extended round head, alternate action	6	22	24, 25
AR30E5R Extended round head, alternate action	8	22	28
AR30F0R Flush round head	8	22	26, 27
AR30F5R Flush round head, alternate action	8	22	28
AR30G0R Round head with half shroud / $\varnothing 24$	8	22	26, 27
AR30G1R Round head with guard ring / $\varnothing 24$	8	22	26, 27
AR30G3L Illuminated, round head with guard ring	6	22	23, 24, 25
AR30G6R Round head with guard ring / $\varnothing 24$, alternate action	8	22	28
AR30G8L Illuminated, round head with guard ring, alternate	6	22	24, 25
AR30JR Cylinder key operated	—	22	33, 34, 35
AR30M0R Mushroom head / $\varnothing 40$	10	22	26, 27
AR30M3R Mushroom head with guard ring / $\varnothing 40$	10	22	26, 27
AR22M4R Mushroom head / $\varnothing 29$	10	22	26, 27
AR30M5R Mushroom head / $\varnothing 40$, alternate action	10	22	28
AR30PCR Knob operated, control type	16	—	—
AR30PL Illuminated, knob operated	14	22	30, 31, 32
AR30PR Knob operated, with round frame	16	22	33, 34, 35
AR30Q2R Push-pull head for emergency stop	12	22	29
AR30S1R Round head with selector ring, 2-position	8	22	29
AR30S2R Round head with selector ring, 2-position	8	22	29
AR30S3R Round head with selector ring, 2-position	8	22	29
AR30S6R Round head with selector ring, 2-position	8	22	29
AR30V2L Illuminated, push-lock for emergency stop	—	22	24, 25
AR30V2R Push-lock for emergency stop / $\varnothing 40$	—	22	28
AR30WR Lever operated with round frame	16	22	33, 34, 35
Pilot lights			
DR30D0L Domed lens	18	—	—
DR30E3L Extended round lens	20	—	—
DR30K0L Faceted lens	18	—	—

≡≡≡ Illuminated pushbutton switch/AR30

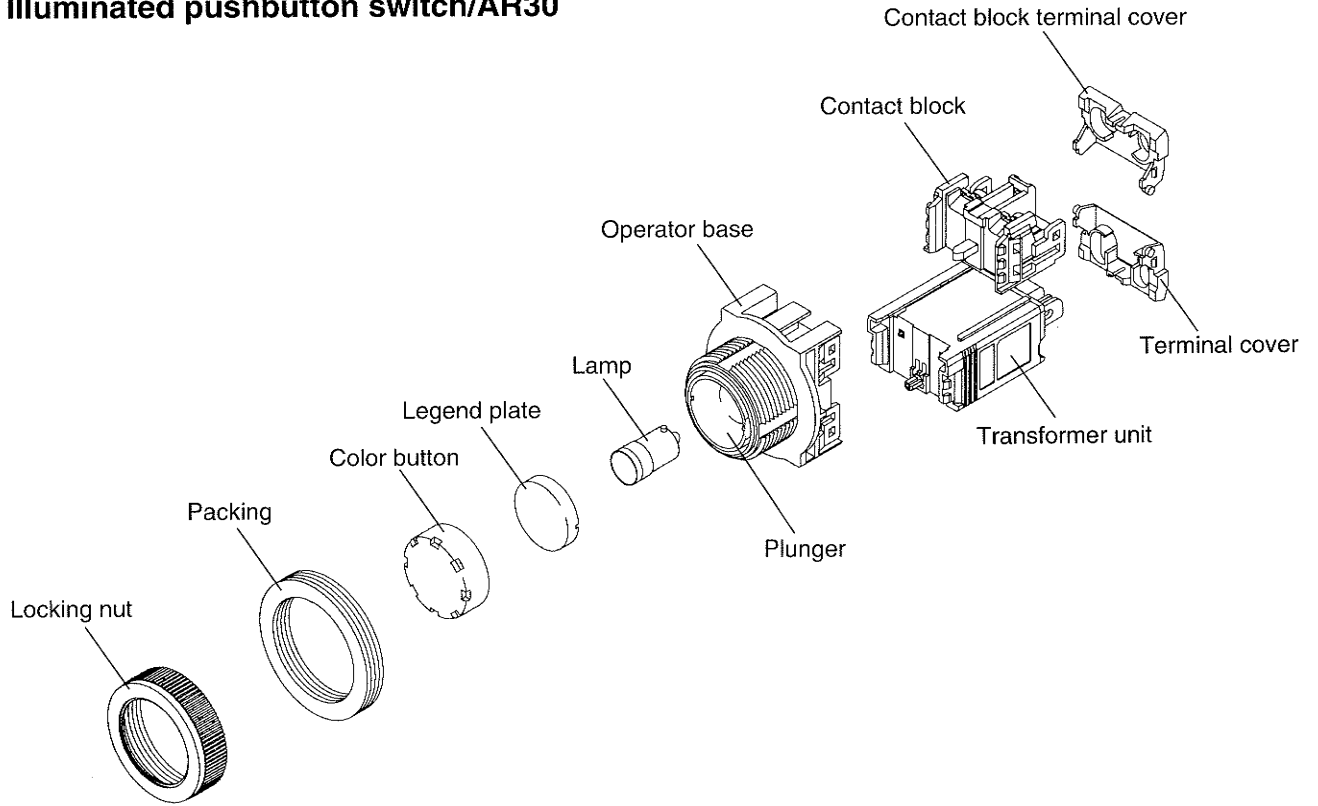

≡≡≡ Pushbutton switch/AR30

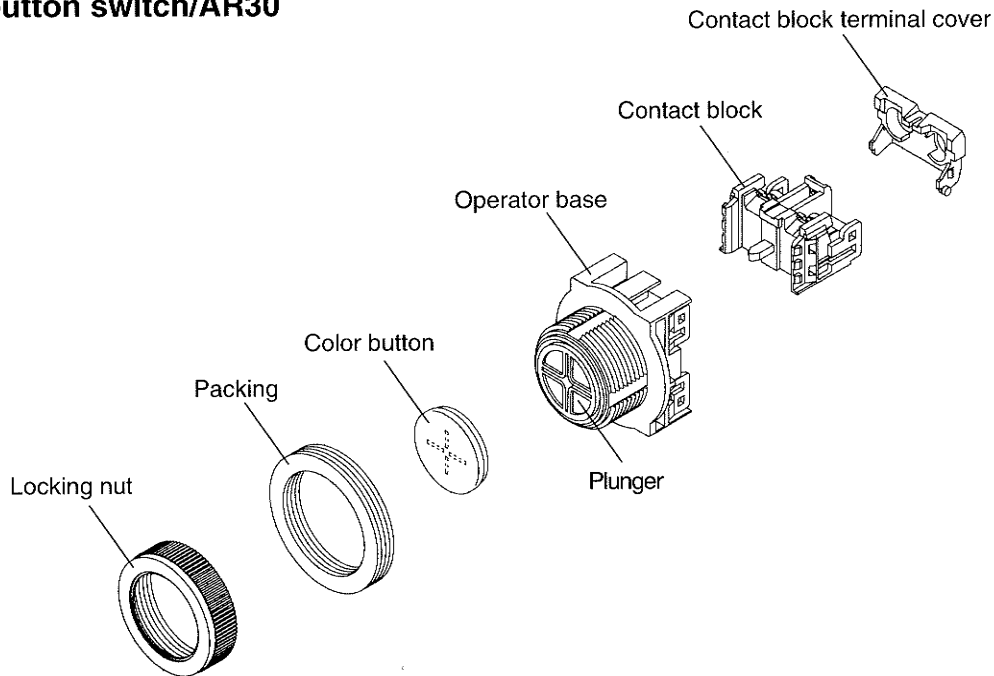

☰ Illuminated selector switch/AR30

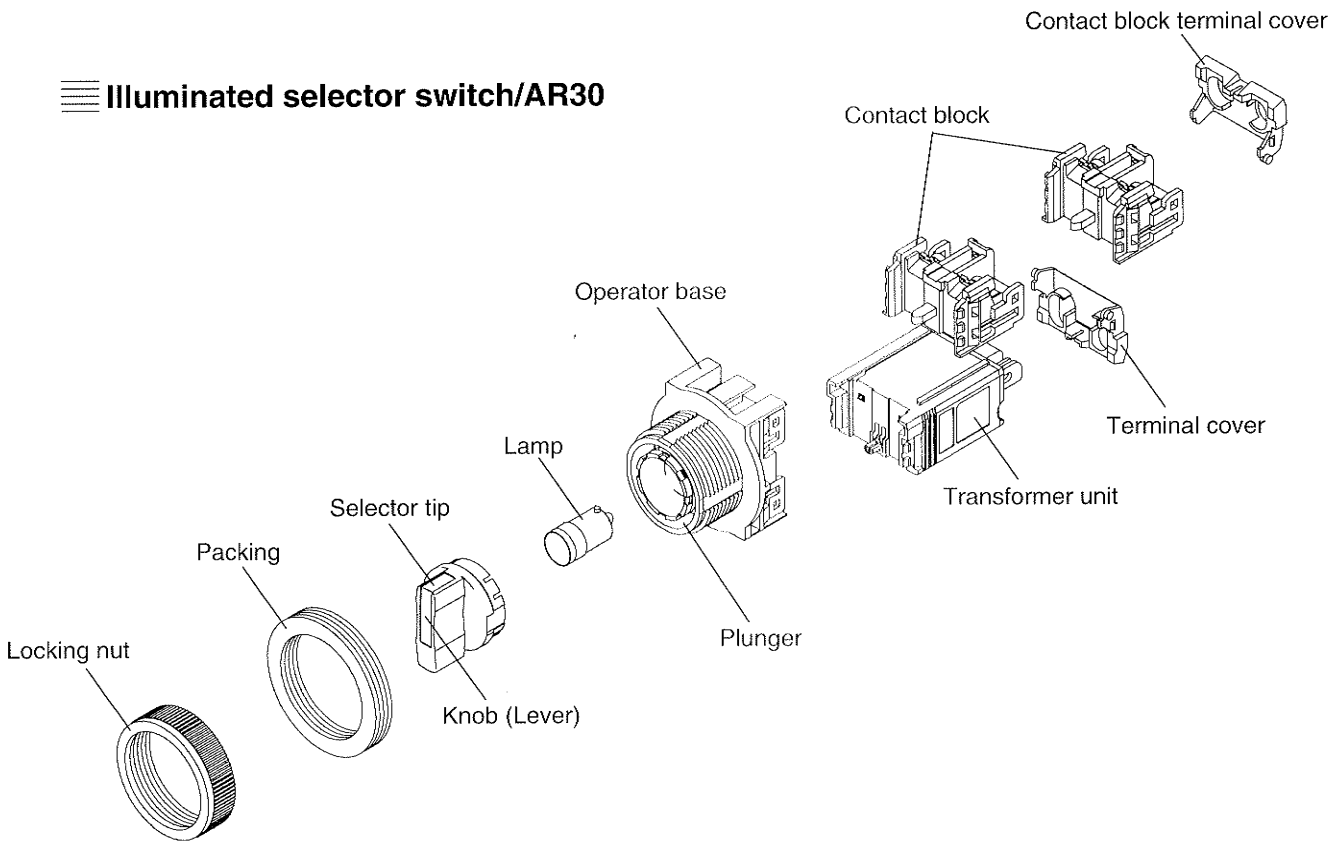

☰ Selector switch/AR30

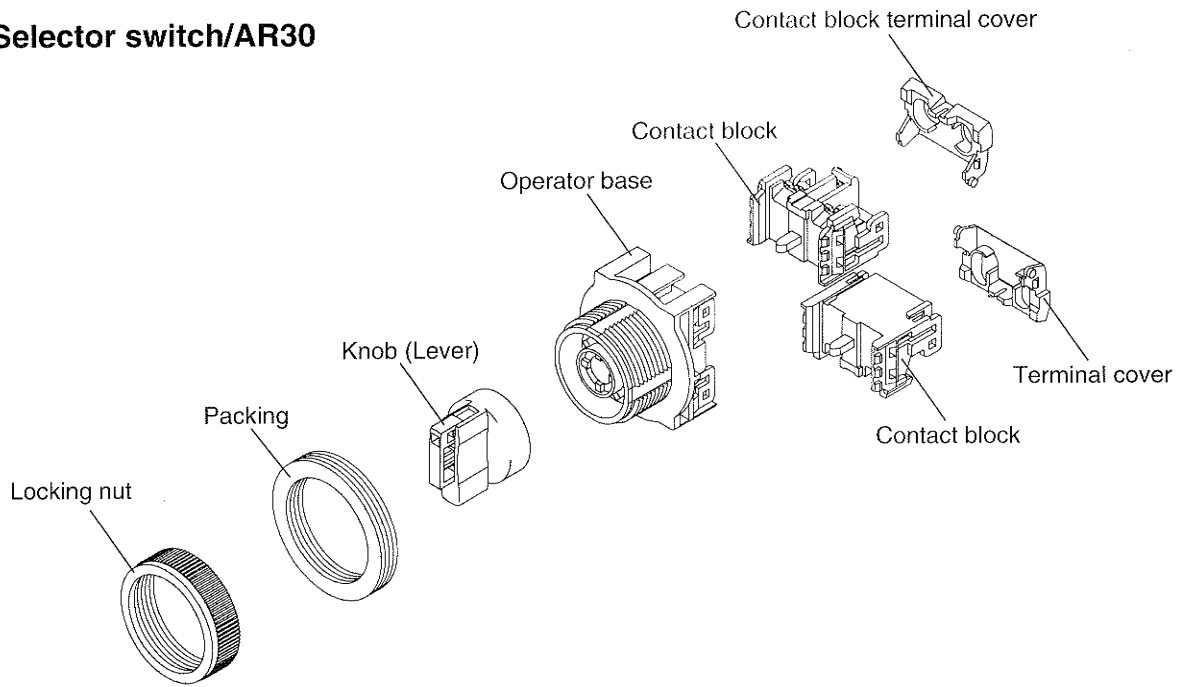

≡ Pilot light/DR30

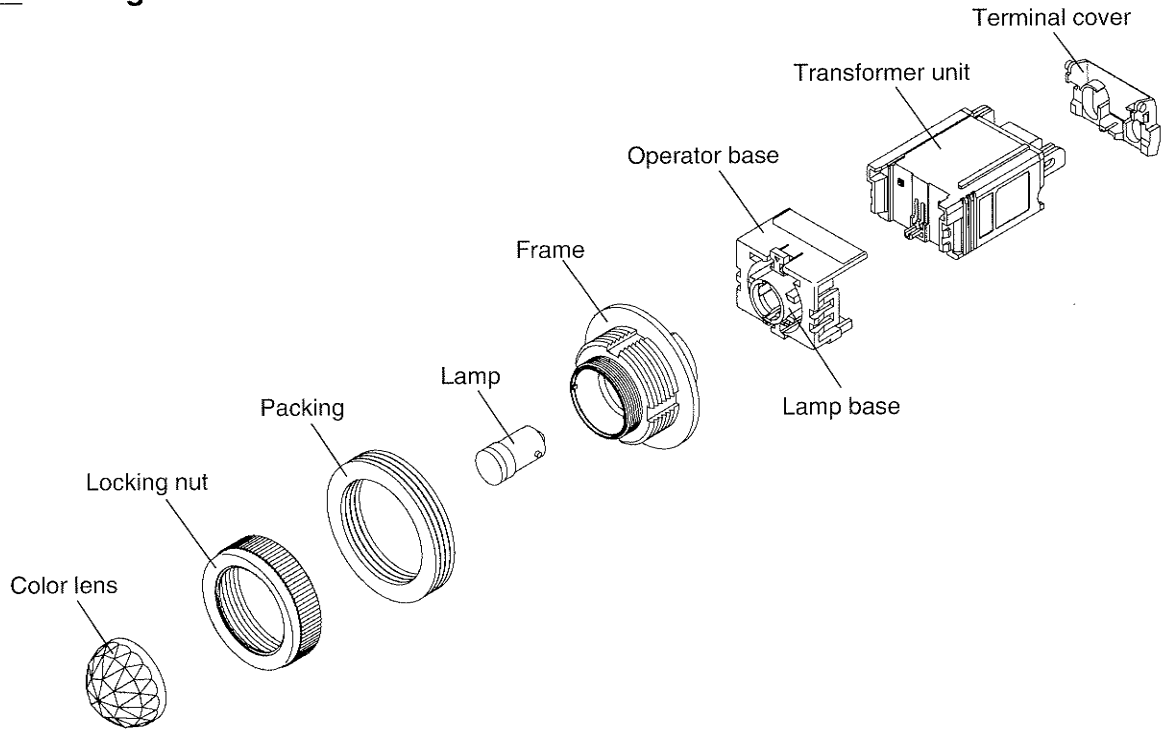

AR30E0L
E5L/Alternate action

AR30G3L
G8L/Alternate action

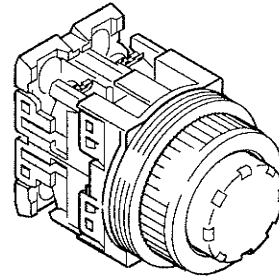

Description	Type(Ordering code) <i>Fill in <input type="checkbox"/> <input type="checkbox"/> with color code</i>	Color code	Tool
Illuminated pushbutton switch	AR30E0L E5L G3L G8L		
Color button	AR9C012-<input type="checkbox"/>	Green G Red R Yellow Y Orange A Clear C Sky blue S*	AR9A004
LED lamp (BA9S/13)	6V AC 48mA DH9L510-A■ 6V DC 56mA DH9L510-6■ 12V AC/DC 34/28mA DH9L510-B■ 24V AC/DC 18/14mA DH9L510-E■	Yellow Y Red R Red/green W Amber A	AH9A790
Contact block	AR9B290 (1NO/Blue) AR9B291 (1NC/Red)		AH9A321

* Color button code **S (Sky blue)** for incandescent bulb only.

Combination of button color and LED lamp color

Luminous color (Type number code)	Color button <input type="checkbox"/>	LED lamp ■
Green G	Green G	Yellow Y
Red R	Red R	Red R
Yellow Y	Yellow Y	Yellow Y
Orange A	Orange A	Amber A
White W	Clear C	Red/Green W

Replacing color button

1. Select the illuminated pushbutton to be modified.
2. Insert the teeth of tool AR9A004 into the grooves of the color button.
3. Remove the color button by unscrewing counterclockwise.
4. Screw the new color button onto the plunger, turning clockwise.

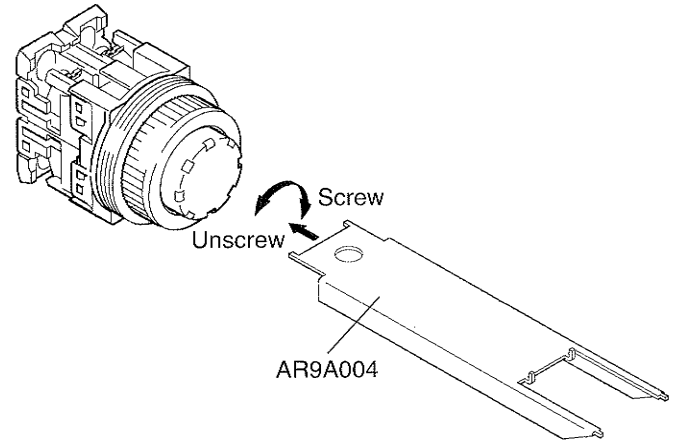

Replacing LED lamp

1. Remove the legend plate AR9P002-W from the plunger.
2. Insert the tip of tool AH9A790 onto the LED lamp.
3. Remove the LED lamp, turning the tool counterclockwise.
4. Place the new LED lamp into the lamp base, turning the tool clockwise.
5. Put the legend plate onto the plunger, fitting its recess slot to projections of plunger.

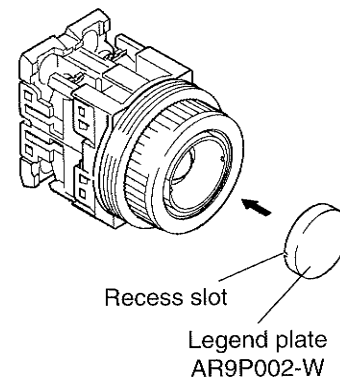
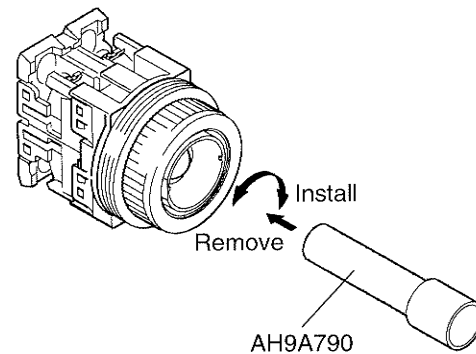

AR30F0R
F5R/Alternate action

AR30E0R
E5R/Alternate action

AR30G1R
G6R/Alternate action
G0R

AR30S1R/With selector ring
S2R/With selector ring
S3R/With selector ring
S6R/With selector ring

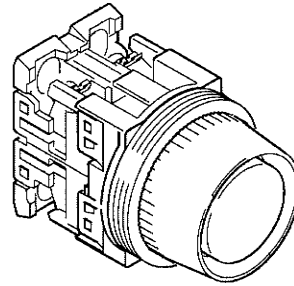

Description	Type(Ordering code) <i>Fill in <input type="checkbox"/> with color code</i>			Color code	Tool
Pushbutton switch	AR30F0R F5R	AR30S1R S2R S3R S6R	AR30E0R E5R G1R G6R G0R		
Color button	AR9C001-<input type="checkbox"/>	AR9C002-<input type="checkbox"/>	AR9C003-<input type="checkbox"/>	Green Red Black Yellow Orange White Sky blue	G R B Y A W S AH9A321
Contact block	AR9B290(1NO/Blue) AR9B291(1NC/Red)				AH9A321

Replacing color button

1. Select the pushbutton to be modified.
2. For AR30G1R and G6R, remove the guard ring, unscrewing counterclockwise.
3. Insert the tip of tool AH9A321 into the slot between color button and frame. Remove the color button, levering the tool.
4. Place the new color button onto the plunger, fitting its cross projections to cross grooves of the plunger.
5. For AR30G1R and G6R, install the guard ring, screwing clockwise.

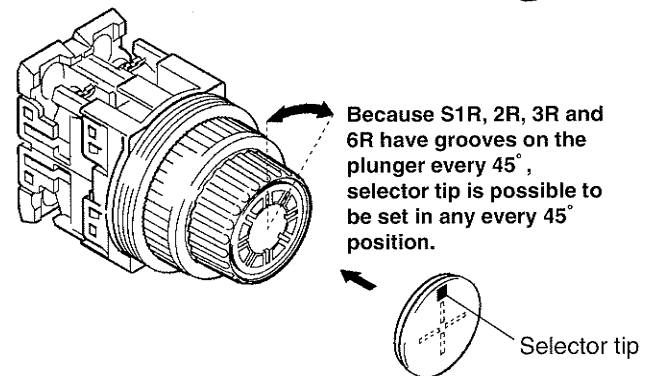
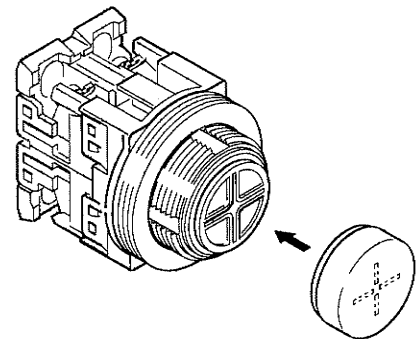
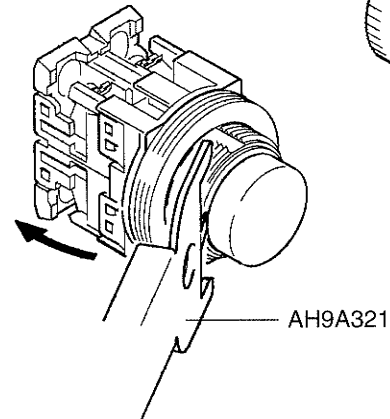
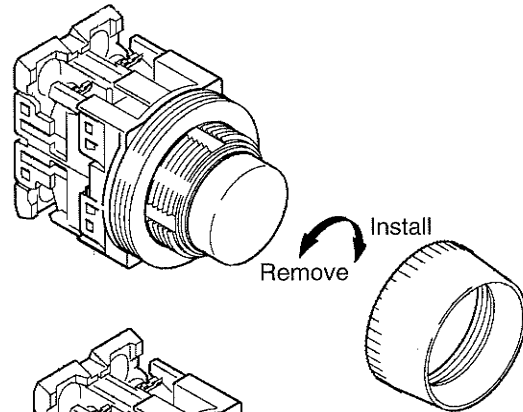

AR30M0R

M5R/Alternate action

M3R

M4R

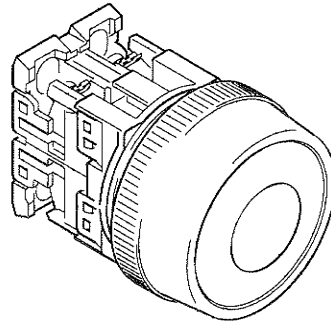

Description	Type(Ordering code) <i>Fill in <input type="checkbox"/> with color code</i>	Color code	Tool
Pushbutton switch	AR30M0R M5R M3R	AR30M4R	
Color button	AR9C007-<input type="checkbox"/>	AR9C006-<input type="checkbox"/>	Green G Red R Black B Yellow Y Orange A White W Sky blue S
Contact block	AR9B290(1NO/Blue) AR9B291(1NC/Red)		AH9A321

AR30Q2R

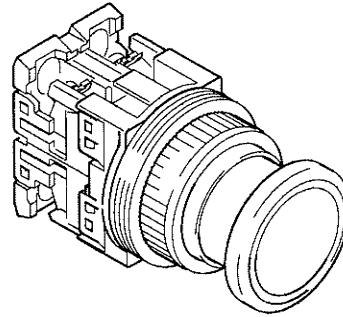

Description	Type(Ordering code) <i>Fill in <input type="checkbox"/> with color code</i>	Color code	Tool
Emergency stop pushbutton switch	AR30Q2R		
Color button	AR9C010-<input type="checkbox"/>	Green G Red R Black B Yellow Y Orange A White W Sky blue S	Screwdriver
Contact block	AR9B290 (1NO/Blue) AR9B291 (1NC/Red)		AH9A321

Replacing color button

1. Select the pushbutton to be modified.
2. Loosen the set screw M3 × 6 by using a screwdriver and remove it from the plunger.

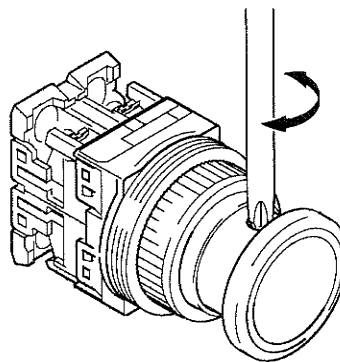

3. Pull the color button free from plunger.
4. Place the new color button on the plunger, aligning the set screw holes.
5. Reinstall the set screw M3 × 6 and tighten.

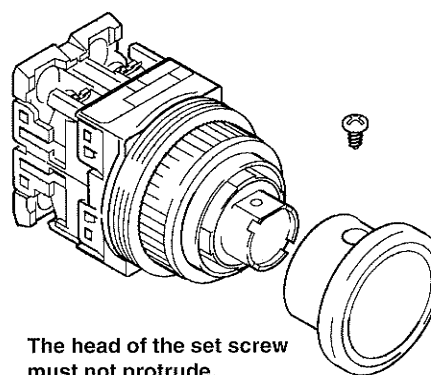

AR30PL

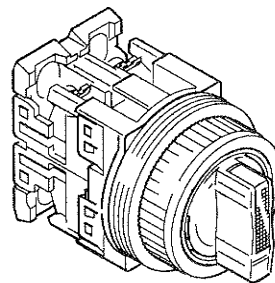

Description	Type(Ordering code) <i>Fill in <input type="checkbox"/> <input checked="" type="checkbox"/> with color code</i>	Color code	Tool
Illuminated selector switch	AR30PL		
Color knob	AR9M005-<input type="checkbox"/>	Green G Red R Yellow Y Orange A White W Sky blue S*	Screwdriver
LED lamp (BA9S/13)	6V AC 48mA DH9L510-A <input checked="" type="checkbox"/> 6V DC 56mA DH9L510-6 <input checked="" type="checkbox"/> 12V AC/DC 34/28mA DH9L510-B <input checked="" type="checkbox"/> 24V AC/DC 18/14mA DH9L510-E <input checked="" type="checkbox"/>	Yellow Y Red R Red/green W Amber A	AH9A790
Contact block	AR9B290 (1NO/Blue) AR9B291 (1NC/Red)		AH9A321

* Color knob code **S (Sky blue)** for incandescent bulb only.

Combination of knob color and LED lamp color

Luminous color (Type number code)	Color knob <input type="checkbox"/>	LED lamp <input checked="" type="checkbox"/>
Green G	Green G	Yellow Y
Red R	Red R	Red R
Yellow Y	Yellow Y	Yellow Y
Orange A	Orange A	Amber A
White W	White W	Red/Green W

Replacing color knob

1. Select the selector switch to be modified.
2. Insert the tip of a small screwdriver into the slot between color knob and frame at one of two cutting of color knob.
3. Using leverage, remove the color knob.
4. Replace the new color knob onto the plunger, pressing until it fits into place.

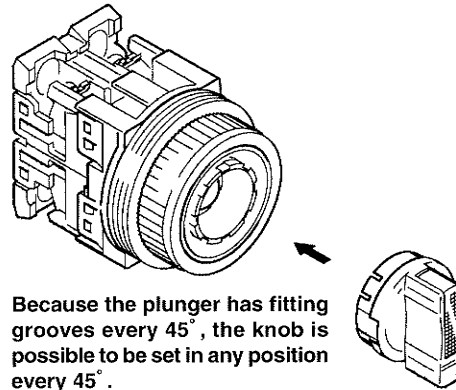
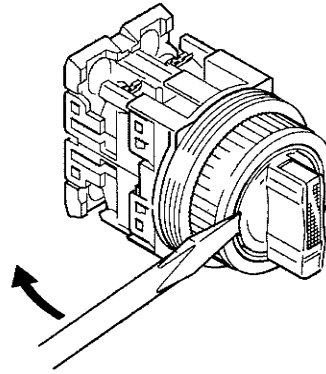

Replacing LED lamp

1. Insert the tip of tool AH9A790 onto the LED lamp.
2. Remove the LED lamp, turning the tool counterclockwise.
3. Place the new LED lamp into the lamp base, turning the tool clockwise.

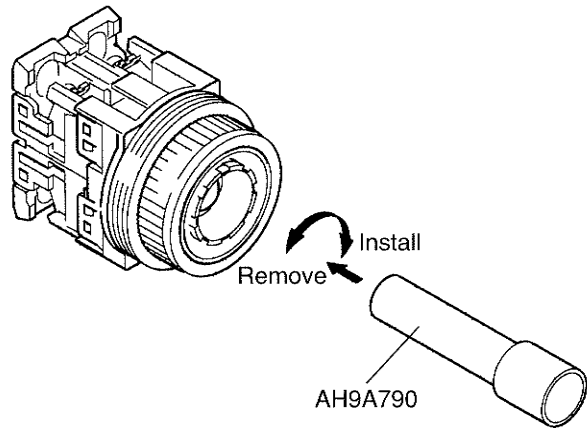

AR30PR
PCR/Control type

AR30WR

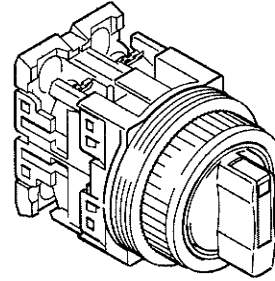

Description	Type(Ordering code) <i>Fill in <input type="checkbox"/> with color code</i>	Color code	Tool
Selector switch	AR30PR AR30WR		
Color knob (lever)	AR9M006-<input type="checkbox"/> AR9M007-<input type="checkbox"/>	Black B Green G Red R	Screwdriver
Contact block	AR9B290 (1NO/Blue) AR9B291 (1NC/Red)		AH9A321

Description	Type(Ordering code) <i>Fill in <input type="checkbox"/> with color code</i>	Color code	Tool
Selector switch Control type	AR30PCR		
Color knob	AR9M006-<input type="checkbox"/>	Black B Green G Red R	Screwdriver
Contact block	Not available		

Replacing color knob (lever)

1. Select the selector switch to be modified.
2. Insert the tip of a small driver into the slot between selector tip and selector knob (lever).
3. Lift the tip up by turning the screwdriver.

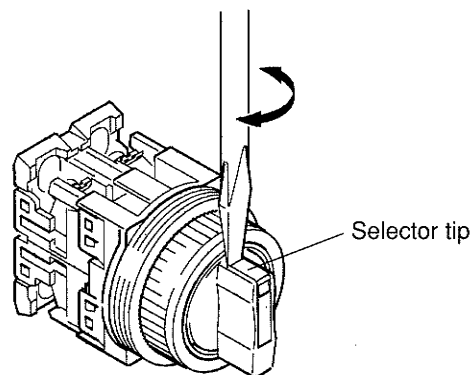

4. Pull the selector knob (lever) free from the plunger.
5. Lift the tip of the new selector knob (lever).
6. Put the selector knob (lever) onto the plunger and press the tip down until it clicks into place.

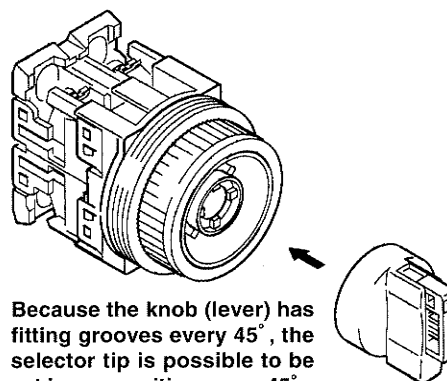

**DR30D0L
K0L**

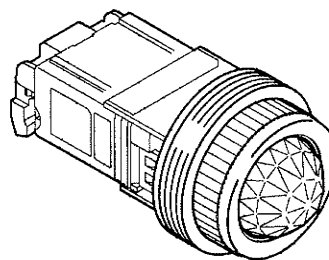

Description	Type(Ordering code) <i>Fill in <input type="checkbox"/> <input checked="" type="checkbox"/> with color code</i>		Color code	Tool
Pilot light	DR30D0L	DR30K0L		
Color lens	DR9C001-<input type="checkbox"/>	DR9C002-<input type="checkbox"/>	Green G Red R Yellow Y Orange A White W Sky blue S*	AH9A702
LED lamp (BA9S/13)	6V AC 48mA 6V DC 56mA 12V AC/DC 34/28mA 24V AC/DC 18/14mA	DH9L510-A ■ DH9L510-6 ■ DH9L510-B ■ DH9L510-E ■	Yellow Y Red R Red/green W Amber A	AH9A790

* Color lens code **S (Sky blue)** for incandescent bulb only.

Combination of color lens and LED lamp color

Luminous color (Type number code)	Color lens <input type="checkbox"/>	LED lamp <input checked="" type="checkbox"/>
Green G	Green G	Yellow Y
Red R	Red R	Red R
Yellow Y	Yellow Y	Yellow Y
Orange A	Orange A	Amber A
White W	White W	Red/Green W

Replacing color lens

1. Select the pilot light to be modified.
2. Remove the color faceted (domed) lens unscrewing counterclockwise using the tool AH9A702.
3. Replace the new color faceted (domed) lens by screwing clockwise.

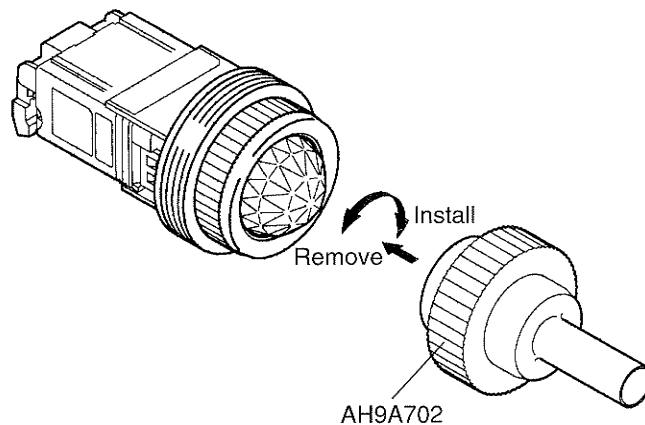
**Replacing LED lamp**

1. Insert the tip of tool AH9A790 onto the LED lamp.
2. Remove the LED lamp, turning the tool counterclockwise.
3. Place the new LED lamp into the lamp base, turning the tool clockwise.

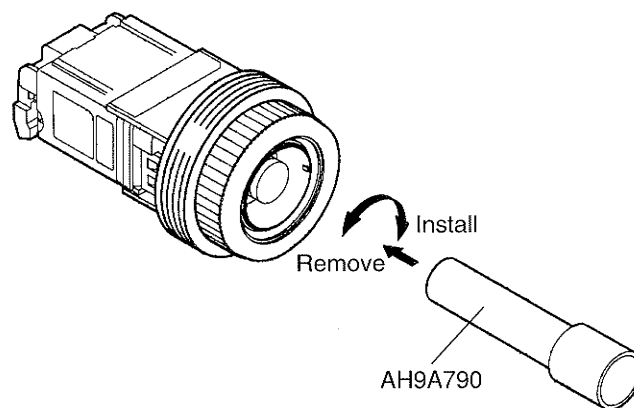

DR30E3L

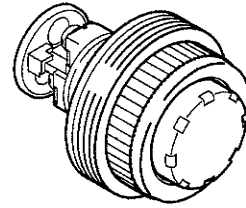

Description	Type(Ordering code) <i>Fill in <input type="checkbox"/> <input checked="" type="checkbox"/> with color code</i>	Color code	Tool
Pilot light	DR30E3L		
Color lens	AR9C012-<input type="checkbox"/>	Green G Red R Yellow Y Orange A Clear C Sky blue S*	AR9A004
LED lamp (BA9S/13)	6V AC 48mA DH9L510-A ■ 6V DC 56mA DH9L510-6 ■ 12V AC/DC 34/28mA DH9L510-B ■ 24V AC/DC 18/14mA DH9L510-E ■	Yellow Y Red R Red/green W Amber A	AH9A790

* Color lens code **S (Sky blue)** for incandescent bulb only.

Combination of color lens and LED lamp color

Luminous color (Type number code)	Color lens <input type="checkbox"/>	LED lamp <input checked="" type="checkbox"/>
Green G	Green G	Yellow Y
Red R	Red R	Red R
Yellow Y	Yellow Y	Yellow Y
Orange A	Orange A	Amber A
White W	Clear C	Red/Green W

Replacing color lens

1. Select the pilot light to be modified.
2. Insert the teeth of tool AR9A004 into the groves of color button.
3. Remove the color lens by unscrewing counterclockwise.
4. Replace the new color lens by screwing clockwise.

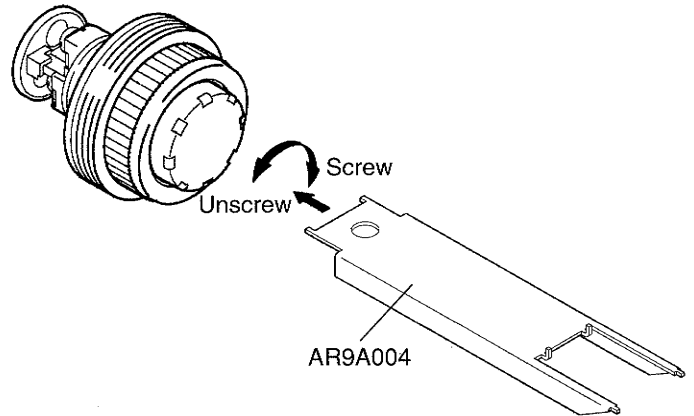

Replacing LED lamp

1. Remove the legend plate AR9P002-W from the plunger.
2. Insert the tip of tool AH9A790 onto the LED lamp.
3. Remove the LED lamp, turning the tool counterclockwise.
4. Place the new LED lamp into the lamp base, turning the tool clockwise.
5. Place the legend plate onto the plunger, fitting its two of four recess slots to two projections of the plunger.

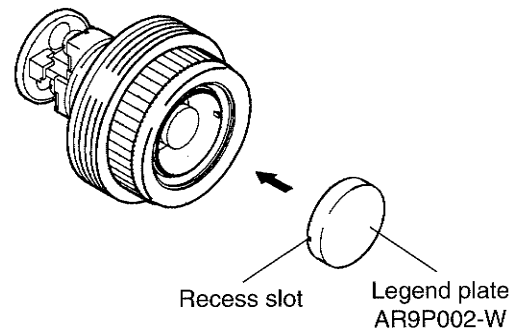
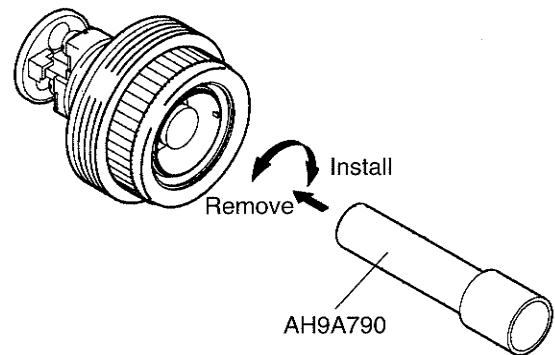

AR30E0L, E0R
 AR30E5L, E5R
 AR30F0R
 AR30F5R
 AR30G0R, G1R, G6R
 AR30G3L, G8L
 AR30M0R
 AR30M3R, M4R

AR30M5R
 AR30S1R, S2R, S3R, S6R
 AR30Q2R
 AR30PR, WR, JR
 AR30PL
 AR30V2L
 AR30V2R

1. Select the illuminated pushbutton, pushbutton or selector switch to be modified.
2. To detach contact block(s) with terminal cover, use tool AH9A321 to open mounting legs slightly, and remove the contact block with terminal cover.

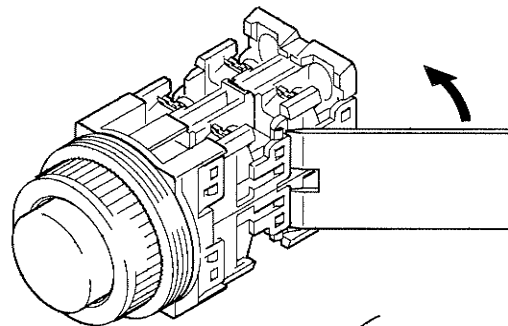

3. Additional contact block(s) without terminal cover can be snap-fitted into the operator base. Push the contact block straight into the mounting legs of the operator base or those of contact block which has been mounted into the operator base until they click into place.
4. Complete the contact block arrangement to mount contact block(s) with terminal cover finally.

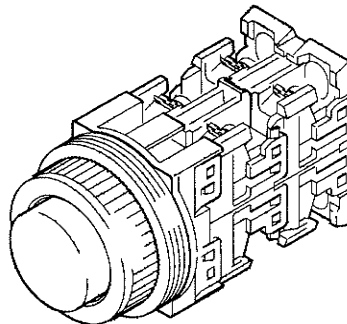
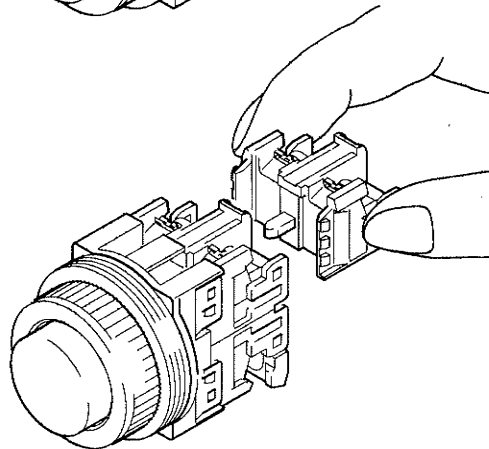

- When adding more than two contact blocks, align the slots on the both sides and make sure that the contact blocks facing each other are not open.
- To handle contact block with terminal cover, don't separate each of them. Because the terminal cover is designed not easy to separate from the contact block.

Illuminated pushbutton switches, without transformer

AR30E0L, G3L ①

Ordering code of contact arrangements

01 1NC

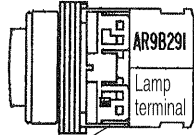

Name plate

02 2NC

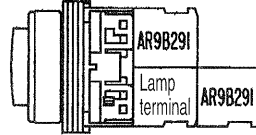

03 3NC

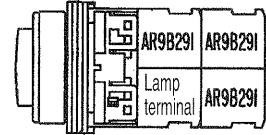

04 4NC

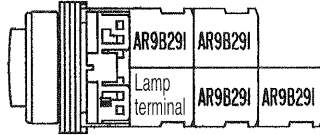

05 5NC

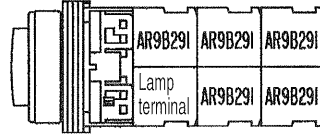

06 6NC

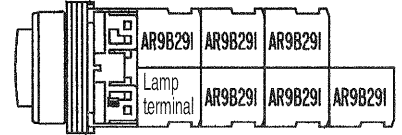

10 1NO

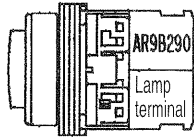

11 1NO • 1NC

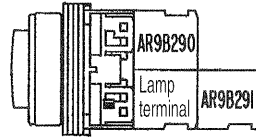

12 1NO • 2NC

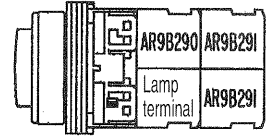

13 1NO • 3NC

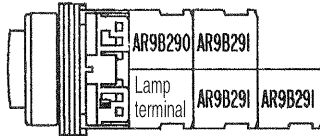

14 1NO • 4NC

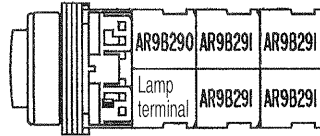

15 1NO • 5NC

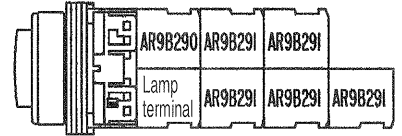

20 2NO

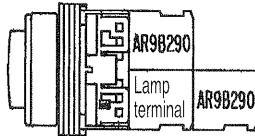

21 2NO • 1NC

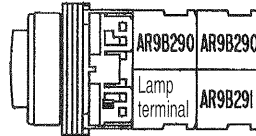

22 2NO • 2NC

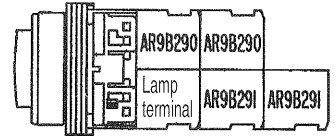

23 2NO • 3NC

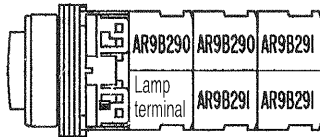

24 2NO • 4NC

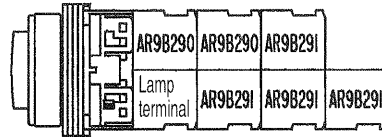

30 3NO

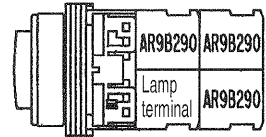

31 3NO • 1NC

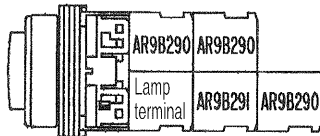

32 3NO • 2NC

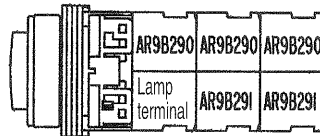

33 3NO • 3NC

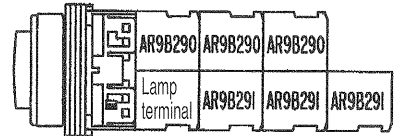

AR30E0L, E0R
 AR30E5L, E5R
 AR30F0R
 AR30F5R
 AR30G0R, G1R, G6R
 AR30G3L, G8L
 AR30M0R
 AR30M3R, M4R

AR30M5R
 AR30S1R, S2R, S3R, S6R
 AR30Q2R
 AR30PR, WR, JR
 AR30PL
 AR30V2L
 AR30V2R

1. Select the illuminated pushbutton, pushbutton or selector switch to be modified.
2. To detach contact block(s) with terminal cover, use tool AH9A321 to open mounting legs slightly, and remove the contact block with terminal cover.

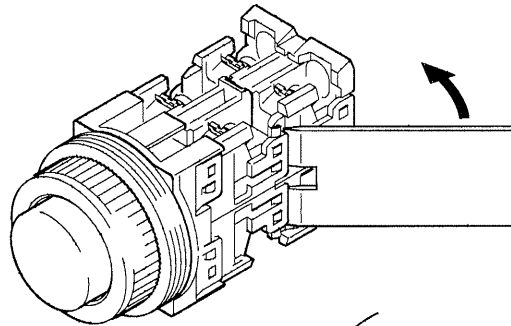

3. Additional contact block(s) without terminal cover can be snap-fitted into the operator base. Push the contact block straight into the mounting legs of the operator base or those of contact block which has been mounted into the operator base until they click into place.
4. Complete the contact block arrangement to mount contact block(s) with terminal cover finally.

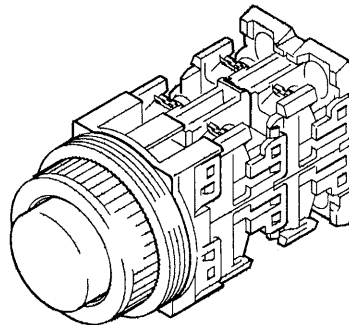
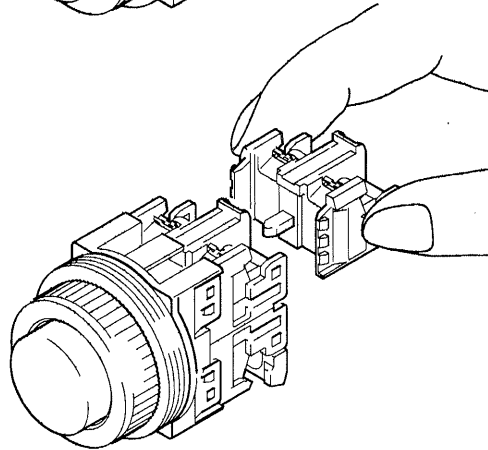

- When adding more than two contact blocks, align the slots on the both sides and make sure that the contact blocks facing each other are not open.
- To handle contact block with terminal cover, don't separate each of them. Because the terminal cover is designed not easy to separate from the contact block.

Illuminated pushbutton switches, without transformer

AR30E0L, G3L ②

Ordering code of contact arrangements

40 4NO

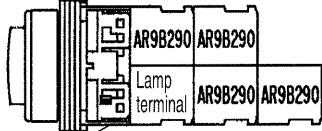

Name plate

41 4NO • 1NC

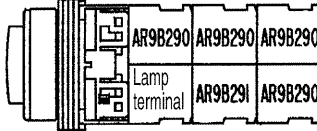

42 4NO • 2NC

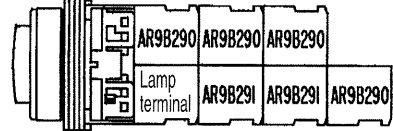

50 5NO

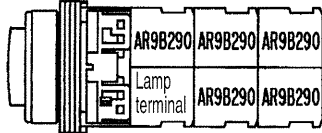

51 5NO • 1NC

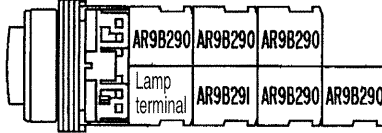

60 6NO

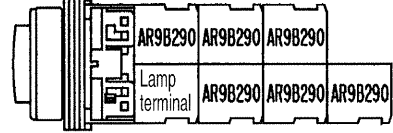

Illuminated pushbutton switches, without transformer

AR30E5L, G8L, AR30V2L

Ordering code of contact arrangements

01 1NC

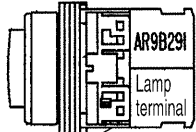

Name plate

02 2NC

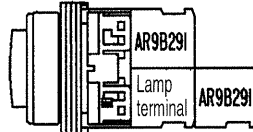

03 3NC

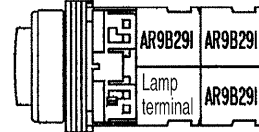

10 1NO

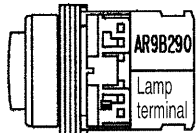

11 1NO • 1NC

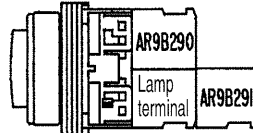

12 1NO • 2NC

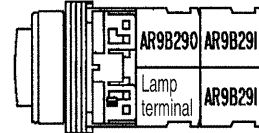

20 2NO

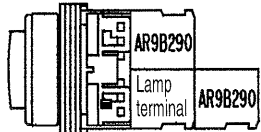

21 2NO • 1NC

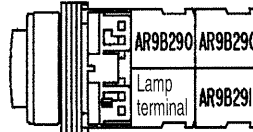

30 3NO

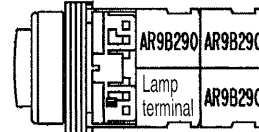

Illuminated pushbutton switches, with transformer
AR30E0L, G3L

Ordering code of contact arrangements

01 1NC

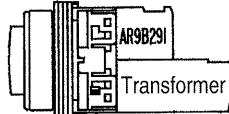

Name plate

04 4NC

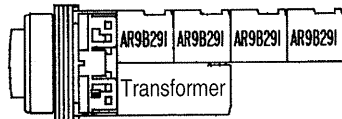

02 2NC

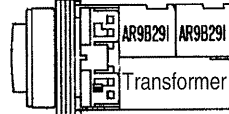

03 3NC

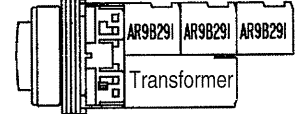

10 1NO

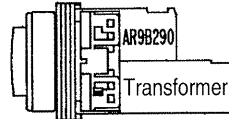

11 1NO • 1NC

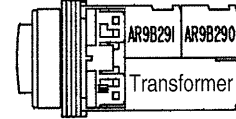

12 1NO • 2NC

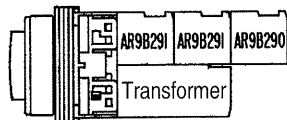

13 1NO • 3NC

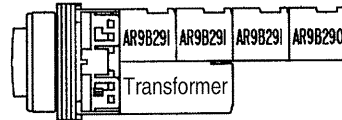

20 2NO

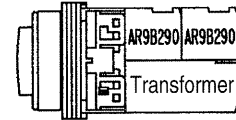

21 2NO • 1NC

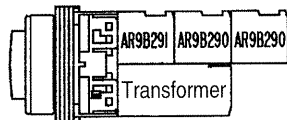

22 2NO • 2NC

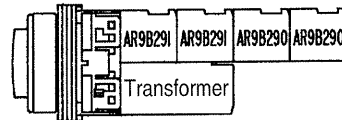

30 3NO

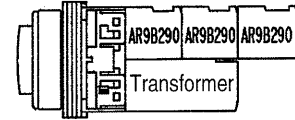

31 3NO • 1NC

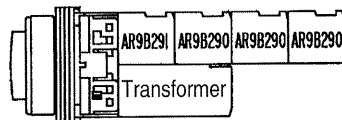

40 4NO

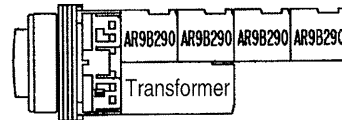

Illuminated pushbutton switches, with transformer
AR30E5L, G8L, AR30V2L

Ordering code of contact arrangements

01 1NC

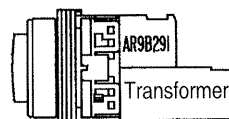

Name plate

02 2NC

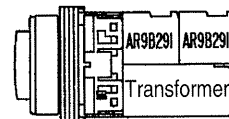

10 1NO

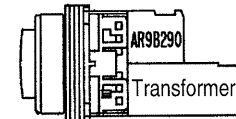

11 1NO • 1NC

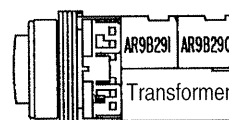

20 2NO

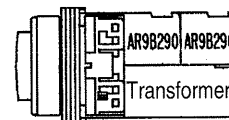

Pushbutton switches

AR30F0R, E0R, G0R, G1R, M0R, M3R, M4R ①

Ordering code of contact arrangements

01 1NC

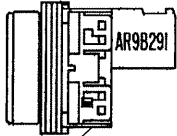

Name plate

02 2NC

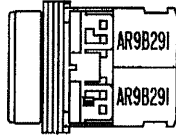

03 3NC

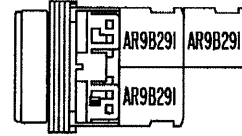

04 4NC

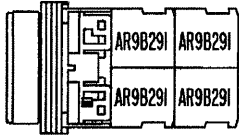

05 5NC

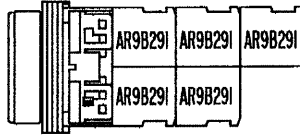

06 6NC

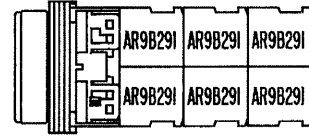

07 7NC

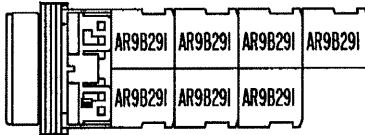

08 8NC

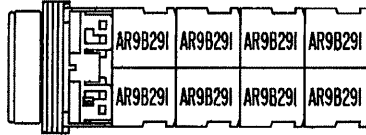

10 1NO

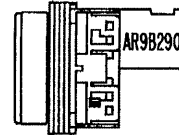

11 1NO • 1NC

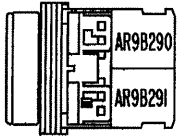

12 1NO • 2NC

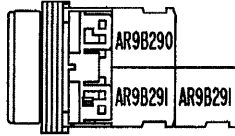

13 1NO • 3NC

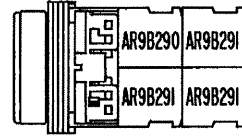

14 1NO • 4NC

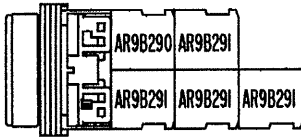

15 1NO • 5NC

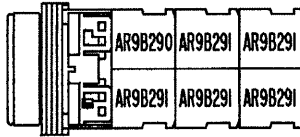

16 1NO • 6NC

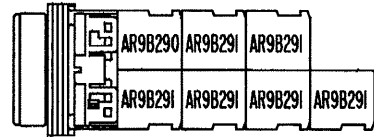

17 1NO • 7NC

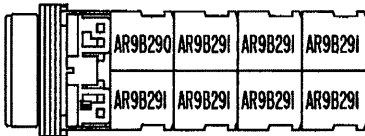

20 2NO

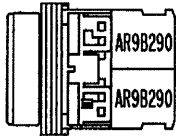

21 2NO • 1NC

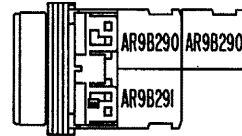

22 2NO • 2NC

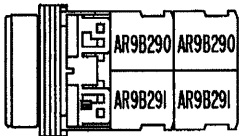

23 2NO • 3NC

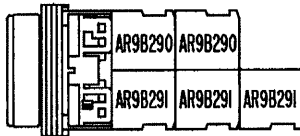

24 2NO • 4NC

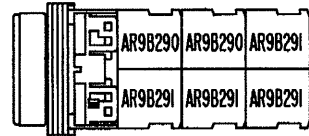

Pushbutton switches

AR30F0R, E0R, G0R, G1R, M0R, M3R, M4R ②

Ordering code of contact arrangements

25 2NO • 5NC

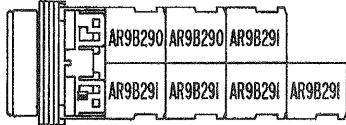

26 2NO • 6NC

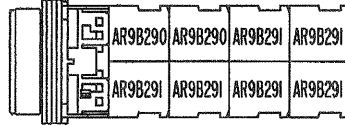

30 3NO

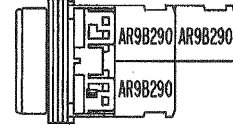

31 3NO • 1NC

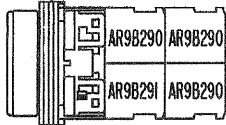

32 3NO • 2NC

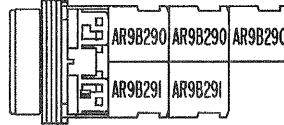

33 3NO • 3NC

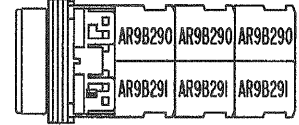

34 3NO • 4NC

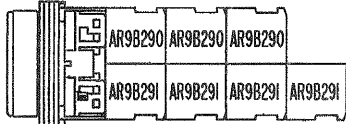

35 3NO • 5NC

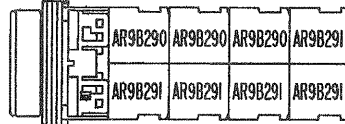

40 4NO

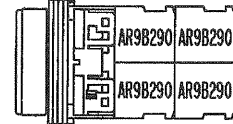

41 4NO • 1NC

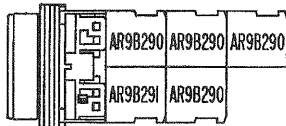

42 4NO • 2NC

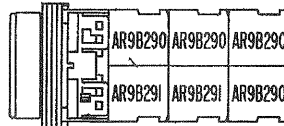

43 4NO • 3NC

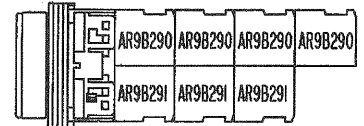

44 4NO • 4NC

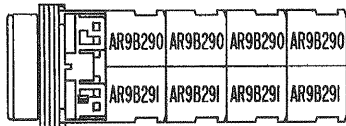

50 5NO

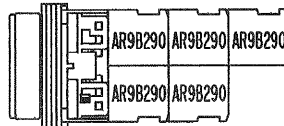

51 5NO • 1NC

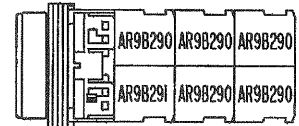

52 5NO • 2NC

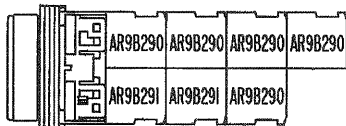

53 5NO • 3NC

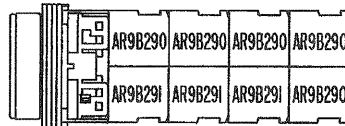

60 6NO

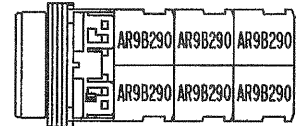

61 6NO • 1NC

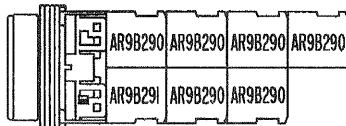

62 6NO • 2NC

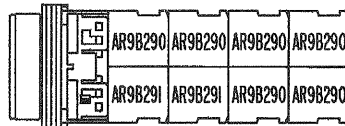

70 7NO

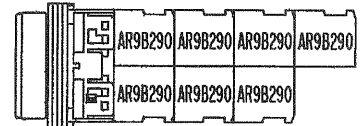

71 7NO • 1NC



80 8NO

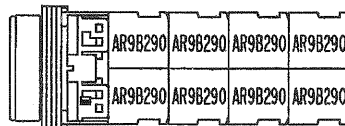

Pushbutton switches
AR30F5R, E5R, G6R, M5R

Emergency stop pushbotton switch
AR30V2R

Ordering code of contact arrangements

01 1NC

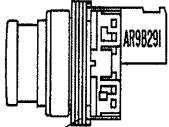

Name plate
04 4NC

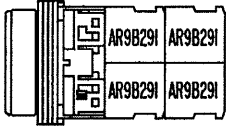

12 1NO • 2NC

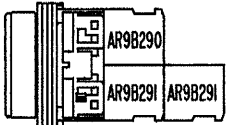

21 2NO • 1NC

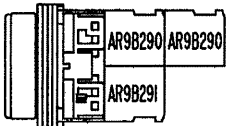

31 3NO • 1NC

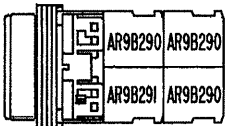

02 2NC

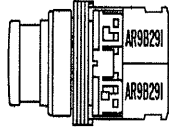

10 1NO

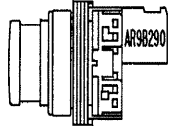

13 1NO • 3NC

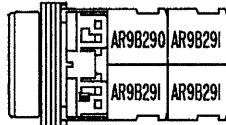

22 2NO • 2NC

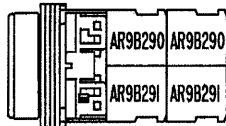

40 4NO

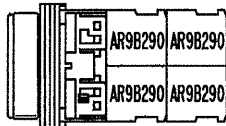

03 3NC

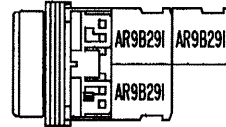

11 1NO • 1NC

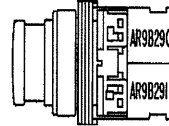

20 2NO

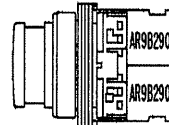

30 3NO

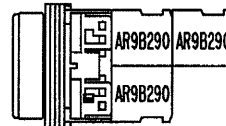

Pushbutton switches, with selector rings
AR30S1R, S2R, S3R, S6R

Ordering code of contact arrangements

S1R, S2R, S3R, S6R

22 2NO • 2NC

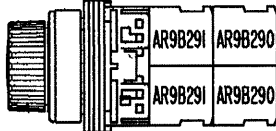

S2R

20 2NO

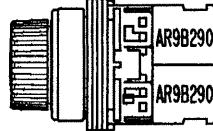

Emergency stop pushbutton switch
AR30Q2R

Ordering code of contact arrangements

01 1NC

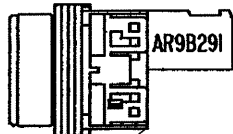

Name plate

02 2NC

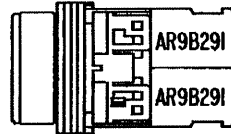

10 1NO

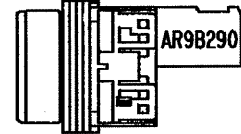

11 1NO • 1NC

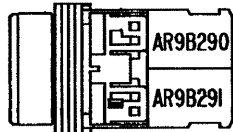

20 2NO

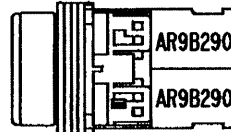

Illuminated selector switches, maintained, without transformer

AR30PL-2, PL-3

Ordering code of contact arrangements

01 1NC

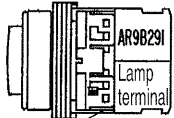

Name plate
04 4NC

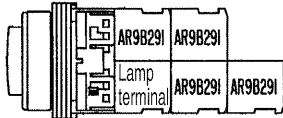

10 1NO

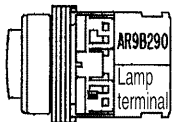

13 1NO • 3NC

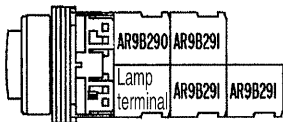

20 2NO

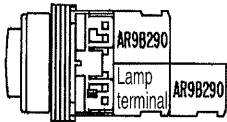

23 2NO • 3NC

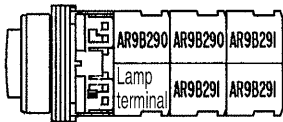

31 3NO • 1NC

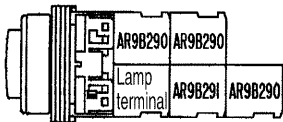

40 4NO

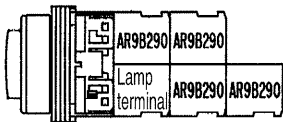

02 2NC

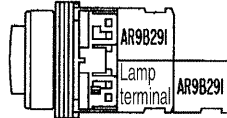

05 5NC

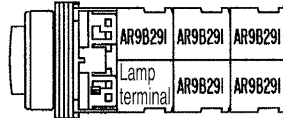

11 1NO • 1NC

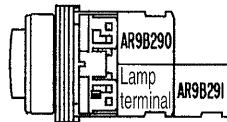

14 1NO • 4NC

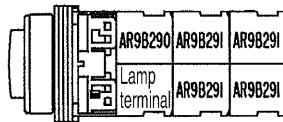

21 2NO • 1NC

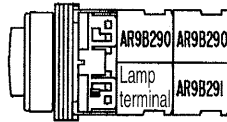

24 2NO • 4NC

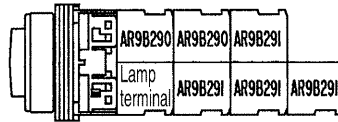

32 3NO • 2NC

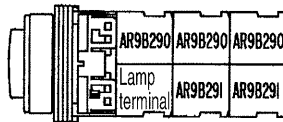

41 4NO • 1NC

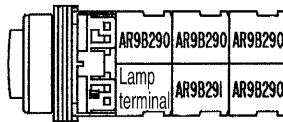

03 3NC

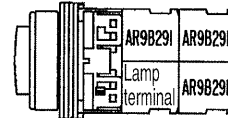

06 6NC

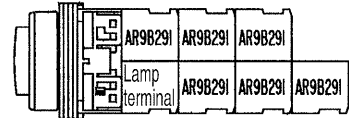

12 1NO • 2NC

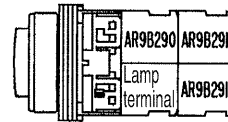

15 1NO • 5NC

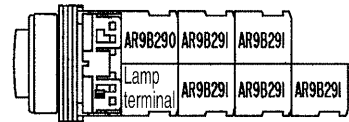

22 2NO • 2NC

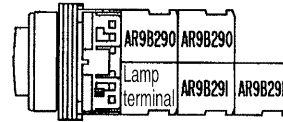

30 3NO

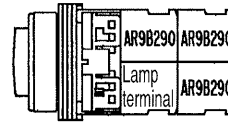

33 3NO • 3NC

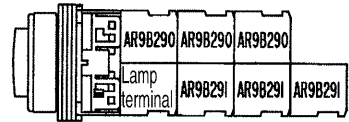

42 4NO • 2NC

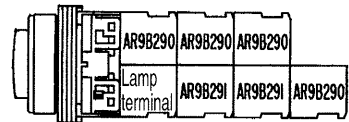

Illuminated selector switches, spring return, without transformer
 Illuminated selector switches, spring/manual return, without transformer

AR30PL-0
AR30PL-6, PL-7

Ordering code of contact arrangements

01 1NC

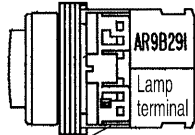

Name plate

02 2NC

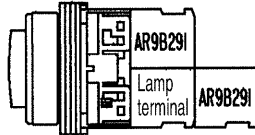

03 3NC

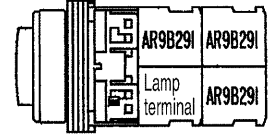

10 1NO

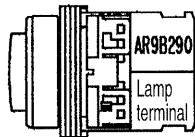

11 1NO • 1NC

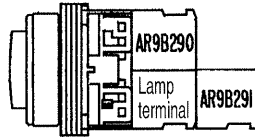

12 1NO • 2NC

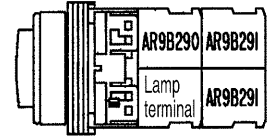

20 2NO

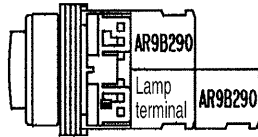

21 2NO • 1NC

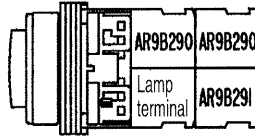

30 3NO

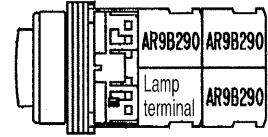

Illuminated selector switches, maintained, with transformer
AR30PL-2, PL-3 ①

Ordering code of contact arrangements

01 1NC

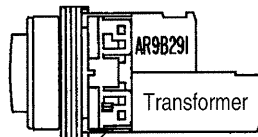

Name plate

02 2NC

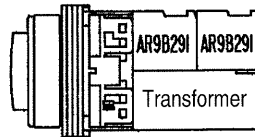

03 3NC

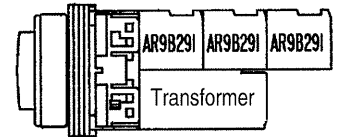

04 4NC

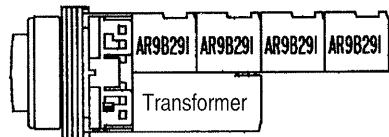

10 1NO

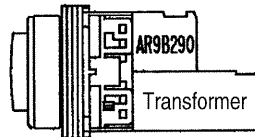

11 1NO • 1NC

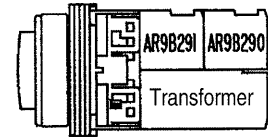

10

Illuminated selector switches, maintained, with transformer

AR30PL-2, PL-3 ②

Ordering code of contact arrangements

12 1NO • 2NC

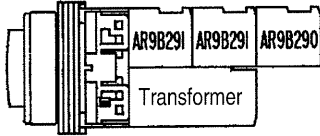

13 1NO • 3NC

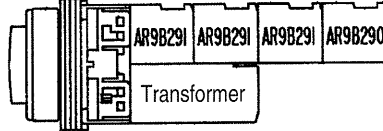

20 2NO

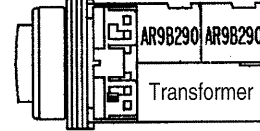

21 2NO • 1NC

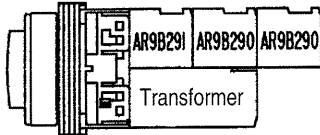

22 2NO • 2NC

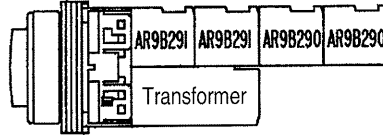

30 3NO

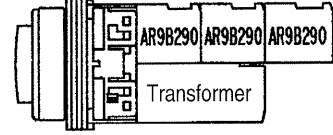

31 3NO • 1NC

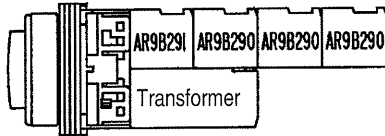

40 4NO

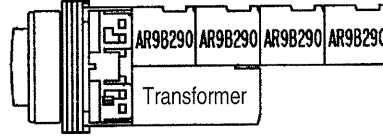

Illuminated selector switches, spring return, with transformer

Illuminated selector switches, spring/manual return, with transformer

AR30PL-0

AR30PL-6, PL-7

Ordering code of contact arrangements

01 1NC

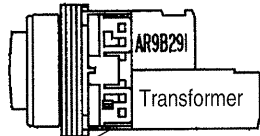

Name plate

02 2NC

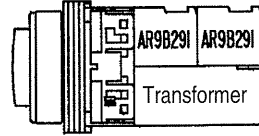

10 1NO

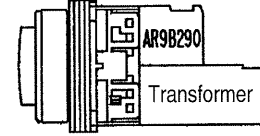

11 1NO • 1NC

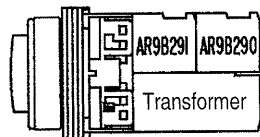

20 2NO

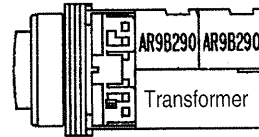

Selector switches, maintained

AR30PR-2, PR-3, WR-2, WR-3, JR-2, JR-3 ①

Ordering code of contact arrangements

01 1NC

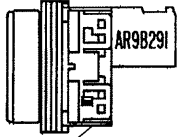

Name plate

02 2NC

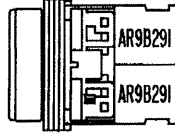

03 3NC

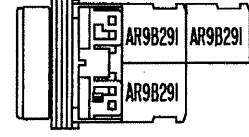

04 4NC

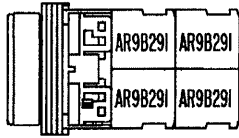

05 5NC

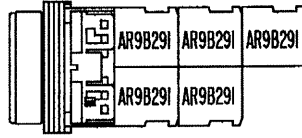

06 6NC

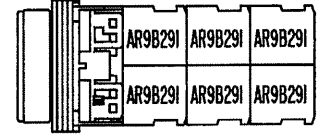

07 7NC

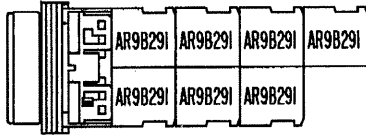

08 8NC

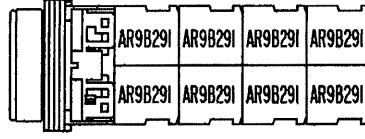

10 1NO

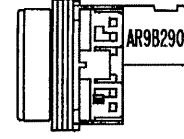

11 1NO • 1NC

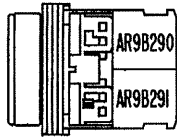

12 1NO • 2NC

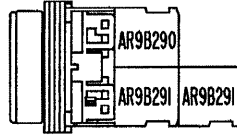

13 1NO • 3NC

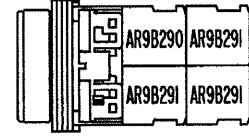

14 1NO • 4NC

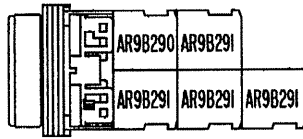

15 1NO • 5NC

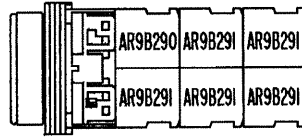

16 1NO • 6NC

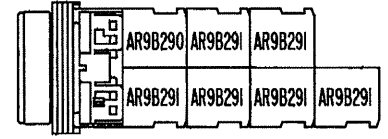

17 1NO • 7NC

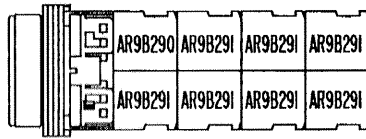

20 2NO

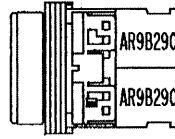

21 2NO • 1NC

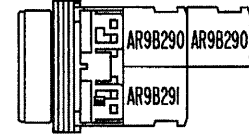

22 2NO • 2NC

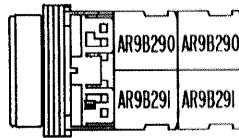

23 2NO • 3NC

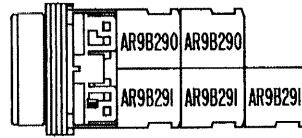

24 2NO • 4NC

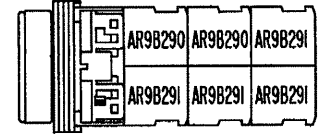

Selector switches, maintained

AR30PR-2, PR-3, WR-2, WR-3, JR-2, JR-3 ②

Ordering code of contact arrangements

25 2NO • 5NC

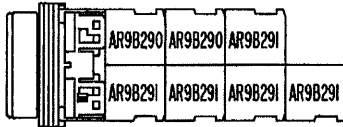

26 2NO • 6NC

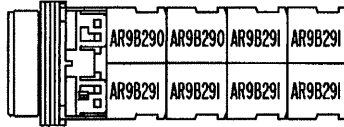

30 3NO

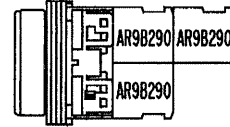

31 3NO • 1NC

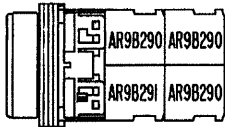

32 3NO • 2NC

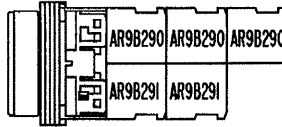

33 3NO • 3NC

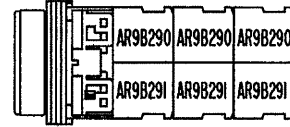

34 3NO • 4NC

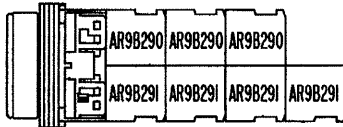

35 3NO • 5NC

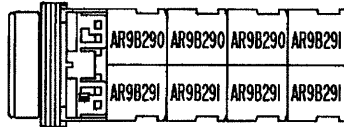

40 4NO

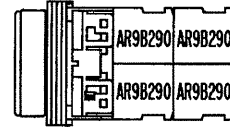

41 4NO • 1NC

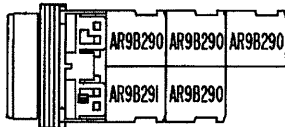

42 4NO • 2NC

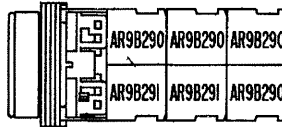

43 4NO • 3NC

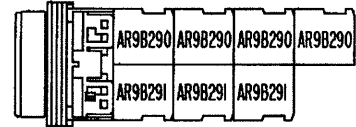

44 4NO • 4NC

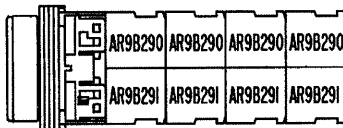

50 5NO

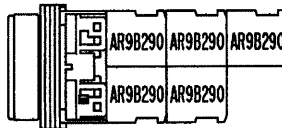

51 5NO • 1NC

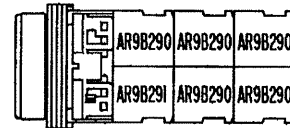

52 5NO • 2NC

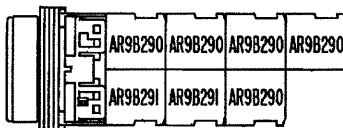

53 5NO • 3NC

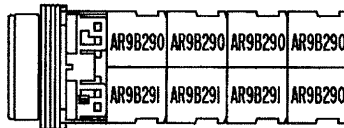

60 6NO

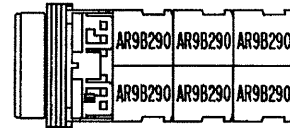

61 6NO • 1NC

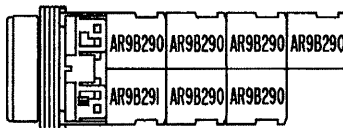

62 6NO • 2NC

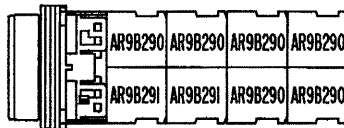

70 7NO

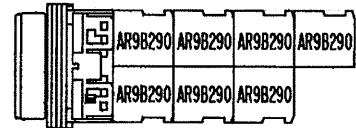

71 7NO • 1NC

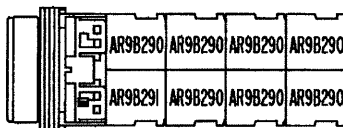

80 8NO

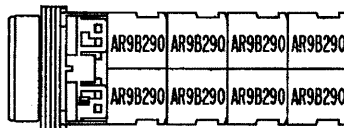

Selector switches, spring return
AR30PR-0, WR-0, JR-0

Selector switches, spring/manual return
AR30PR-6, WR-6, JR-6, PR-7, WR-7, JR-7

Ordering code of contact arrangements

01 1NC

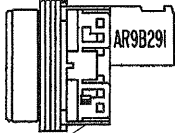

Name plate

02 2NC

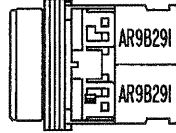

03 3NC

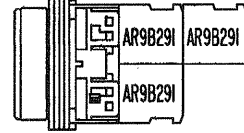

04 4NC

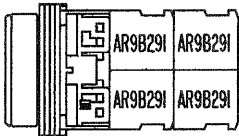

10 1NO

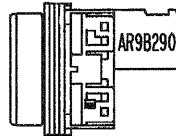

11 1NO • 1NC

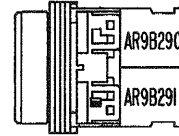

12 1NO • 2NC

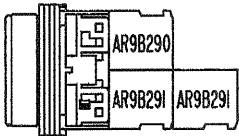

13 1NO • 3NC

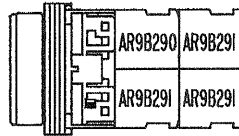

20 2NO

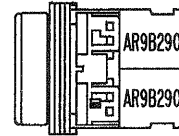

21 2NO • 1NC

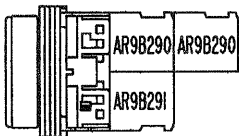

22 2NO • 2NC

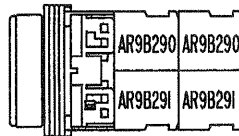

30 3NO

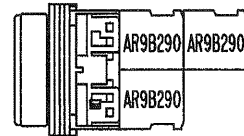

31 3NO • 1NC

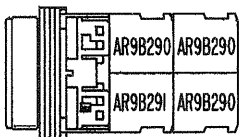

40 4NO

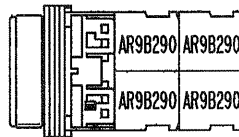

Selector switches, spring return
AR30PR-1, WR-1, JR-1

Ordering code of contact arrangements

20 2NO

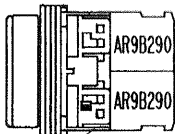

Name plate

22 2NO • 2NC

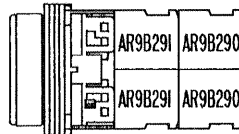

Fuji Electric Co.,Ltd.

5-7, Nihonbashi Odemma-cho, Chuo-ku
Tokyo 103-0011, JAPAN
[Http://www.fujielectric.co.jp/fcs/eng](http://www.fujielectric.co.jp/fcs/eng)

Fuji Electric Corp. of America

47520 Westinghouse Drive
Fremont, CA 94539
Phone: 510-440-1060
Fax: 510-440-1063
[Http://www.fujielectric.com/fecoa](http://www.fujielectric.com/fecoa)

Printed on recycled paper