

# RNJ

Rack and panel cylindrical connectors



**Amphenol**



Connecting people + technology

[www.amphenol-socapex.com](http://www.amphenol-socapex.com)

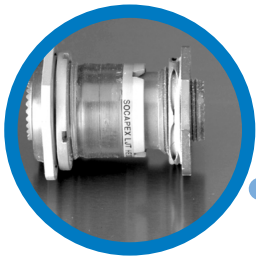

# RNJ

Rack and panel cylindrical connectors

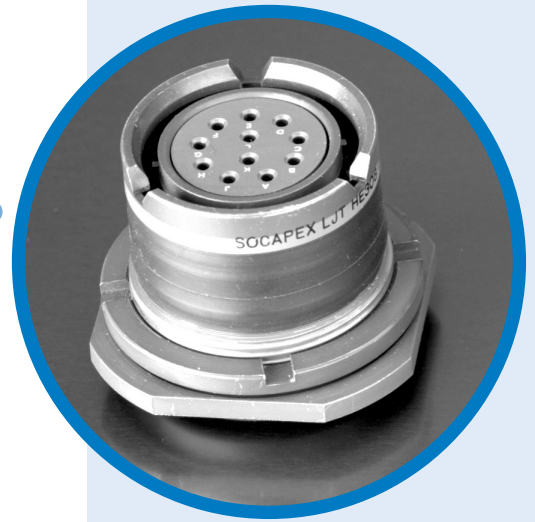

## MAIN CHARACTERISTICS

- EMI shielding
- Shells are grounded before contact mating
- Lightweight space saving design
- Durability: 500 cycles
- Moisture resistance: in addition to interfacial seal, main joint souffler and rear gasket on the plug are set up for moisture sealing between connector halves
- Corrosion resistance:
  - Olive drab cadmium over nickel plating on aluminium shell (withstands 500 hours of salt spray exposure) or electroless nickel
  - Free cadmium version also available.
- 8 shell sizes from 11 to 25
- Contact protection:
  - 100% scoop-proof. The design prevents bent pins and a short circuit occurring during mating.
  - Between 1 and 128 contacts in accordance with Mil-C-39029 standard
  - Crimp contacts sizes 22D, 20, 16, 12, 8, 4, 00.
  - PCB contacts sizes 22D & 20 (size 16, 12, 8, please consult Amphenol)
  - Wire-wrap contacts sizes 22D & 20
  - Optical termini (POM series) in accordance with Mil-T-29504 standard
- For environmental applications: supplied without rear accessories. Design provides serrations on rear threads of shells. Compatible with some M 85049 rear accessories for MIL-DTL-38999 I connectors. Please consult us.
- Temperature range: -65°C +175°C
- Insulation resistance > 5000 Mohms at ambient temperature under 500 Vcc

Figure 1 - FEATURES

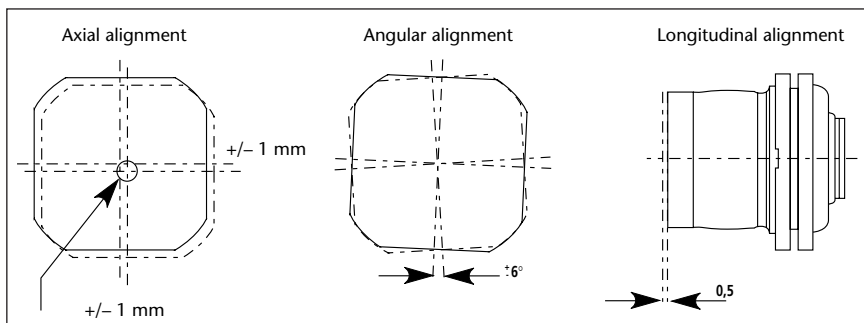

## DESCRIPTION

The RNJ series rack and panel connectors are qualified for the requirements of the standard DAT C 5935 x 0005 HE308 21, 25, 26 & 27T models.

They are used to connect electrical and optical devices between a moving unit (rack) and a fixed unit (panel) without any coupling / uncoupling device. This function is ensured by a system of moving and the fixed units.

The connectors are built to allow for design tolerances (up to the limits shown in figure 1) during the mating of the connectors and the final locking of the moving and fixed units.

These connectors are derived from the LJT series and meet or exceed the MIL-DTL-38999 Series I requirements.

## RNJ: the environmental rack connection

## APPLICATIONS

- Military applications & Aeronautic
- Advanced industrial applications

RNJ



Amphenol

## Presentation

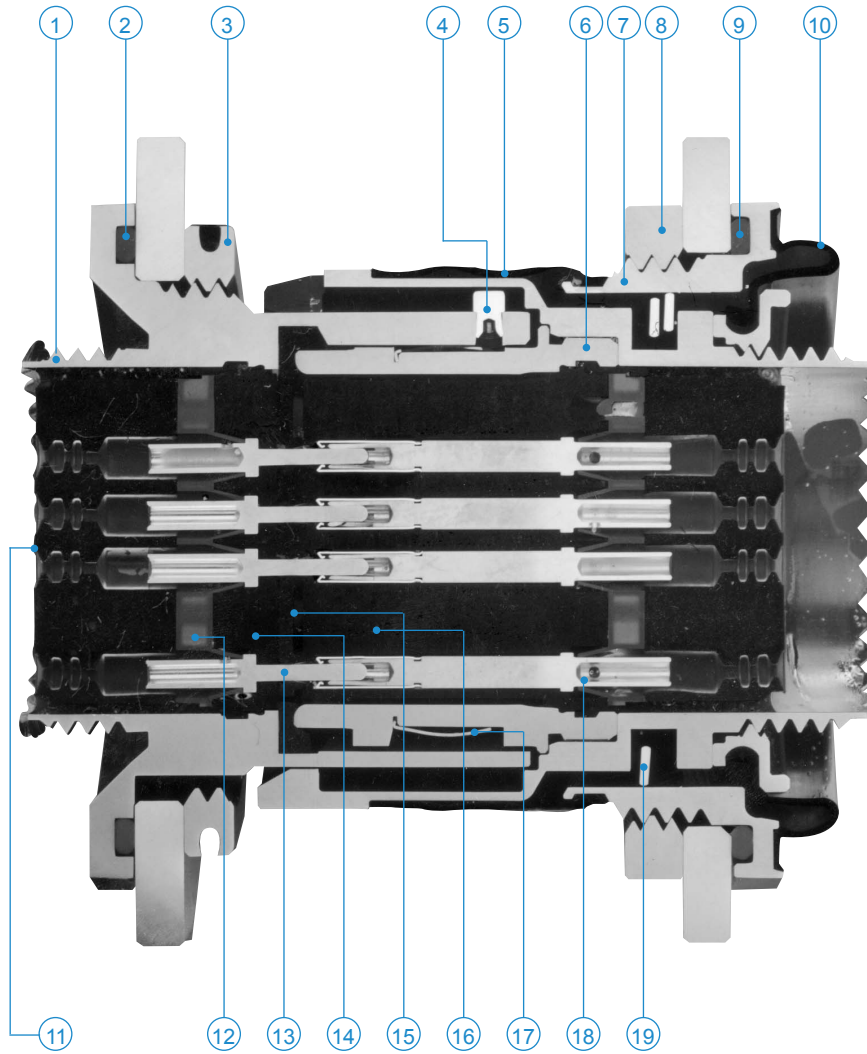

- 1 - Receptacle shell
- 2 - O ring
- 3 - Hexagonal nut
- 4 - Rivet
- 5 - Sealed membrane
- 6 - Free plug shell
- 7 - Fixed plug shell
- 8 - Panel nut (plug)
- 9 - O ring
- 10 - Sealed membrane
- 11 - Grommet
- 12 - Dielectric retention disc
- 13 - Pin contact
- 14 - Male insert
- 15 - Interfacial seal
- 16 - Female insert
- 17 - Grounding fingers
- 18 - Socket contact
- 19 - Spring washers

## Environmental characteristics

- Temperature range: -65°C to +175°C
- High temperature endurance 1000 hours
- Humidity 100% R.H.
- Air leakage:
  - Receptacles RNJ27: 16 cm<sup>3</sup> / h max under 2 bars pressure
  - Floating RNJ26 - 46:
    - Front Face: 16 cm<sup>3</sup> / h max under 2 bars pressure
    - Rear Face: 4 cm<sup>3</sup> / h max under 0,5 bar pressure (higher pressure withstanding available on request)
- Salt spray:
  - olive drab cadmium 500 h
  - electroless nickel 48 h
- Fluid resistance:
  - MIL-L-7808 (lubricating oil)
  - MIL-L-23699 (lubricating oil)
  - MIL-H-5606 (hydraulic fluid)
  - Hydraulic fluid (Chevron M2V)
  - MIL A-8243 (defrosting fluid)
  - MIL- C- 87936 type I
  - MIL-T-5624 (JP5)
  - MIL-C-47220 or Coolanol 25 or equivalent
  - MIL-G-3056 type I (gasoline)
  - Isopropyl alcohol per TT-I-735 grade A or B mixed with mineral spirit TT-T-291 type I or P-D-680 type I

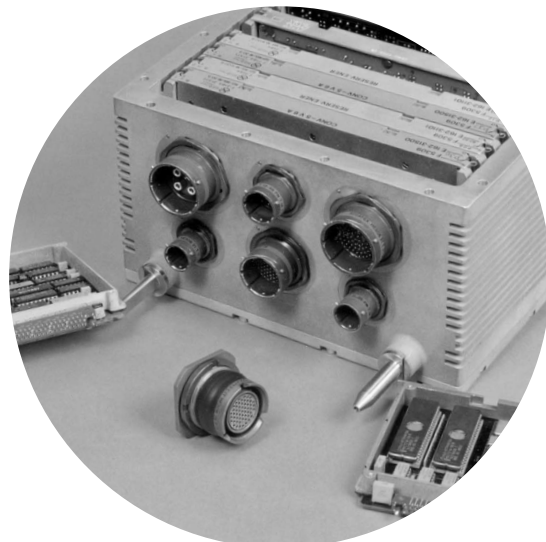

## Mechanical characteristics

- Insert retention in the shell: 7 bars
- Contact retention in the insert:

Contact size	22D	20	16	12	8	4	00
Maximum load (N)	45	67	110	110	150	150	150

- Mating and unmating forces

Shell size	Maximum mated force (daN)	Maximum unmated force (daN)
11	20	12
13	30	13
15	35	15
17	50	16
19	55	18
21	65	22
23	80	27
25	102	34

- Durability: 500 cycles
- Sine vibrations 10 . 2000 Hz 30g
- Random vibrations 10 . 2000 Hz 28g
- Shocks: 150g 3 ms 1/3 sinus

## Electrical characteristics

- Contact rating: nominal current per contact:

Contact size	22D	20	16	12	8	4	00
Current (A)	5	7.5	13	23	60	100	230

- Contact resistance:

Contact size	22D	20	16	12	8	4	00
Contact resistance (mohms)	8	4.7	2	1.1	0.6	0.26	—

- Insulation resistance: - at ambient > 10<sup>5</sup> Mohms  
- at maximum temperature > 10<sup>3</sup> Mohms

- Service rating:

Service (p. 4/5)	Dielectric withstanding voltage (Vrms)								Working voltage	
	At sea level		15000 meters		21000 meters		34000 meters		Vrms	Vdc
	mated	unmated	mated	unmated	mated	unmated	mated	unmated		
M	1300	1300	800	550	800	350	800	200	400	550
I	1800	1800	1000	600	1000	400	1000	200	600	850
II	2300	2300	1000	800	1000	500	1000	200	900	1250

- Dimensions of acceptable contacts and cables:

Contact size	Contact Diameter mm (in)	Crimp barrel		Acceptable cables						
		Diameter mm (in)	Depth mm (in)	Gauge AWG Section mm <sup>2</sup> (sq in)				Outside diameter mm (in)		
				22	24	26	28	min	average	Max
22D	0.76 (0.030)	0.88±0.03 (0.035±0.001)	3.58 (0.141)	0.38 (0.015)	0.22 (0.009)	0.15 (0.006)	0.095 (0.004)	0.76 (0.03)	1.20 (0.047)	1.37 (0.054)
				20	20	24				
16	1.57 (0.062)	1.70±0.03 (0.067±0.001)	5.30 (0.209)	16	18	20		1.68 (0.066)	2.41 (0.095)	2.77 (0.109)
				12	14					
8	3.60 (0.039)	4.6 +0.05 (0.181+0.002)-0	10 (0.394)	8				4.50 (0.177)	—	5.8 (0.228)
				Min: 8.98 - Max: 10 (Min: 0.354 - Max: 0.394)						
4	5.75 (0.226)	7.4±0.05 (0.291±0.002)	12 (0.4724)	21.10 (0.831)				7.73 (0.304)	8.08 (0.318)	8.43 (0.332)
00	12 (0.472)	14.6+0.05 (0.575±0.002)	21 (0.827)	100 (3.937)				13.3 (0.524)	—	14.7 (0.579)

## Insert arrangements

### Front face view of male insert

The major keyway is shown in the «normal» position

Contact size	22D	20	16	12	8	4	00
Caption							

① : RNJ insert arrangement reference

② : Number of contacts

③ : Contact sizes

④ : Service (See page 3)

#### SIZE 11 SHELL

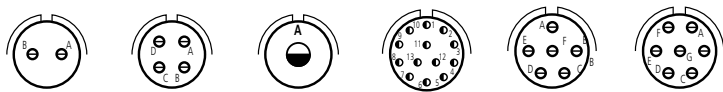

①	11-2	11-4	11-12	11-35	11-98	11-99
②	2	4	1	13	6	7
③	20	20	12	22D	20	20
④	I	I	II	M	I	I

#### SIZE 13 SHELL

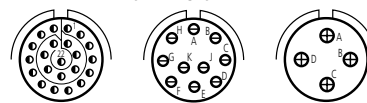

①	13-35	13-98	13-4
②	22	10	4
③	22D	20	16
④	M	I	I

#### SIZE 13 SHELL

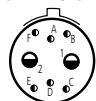

①	13-26
②	6+2
③	22D 12
④	M

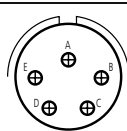

①	15-5
②	5
③	16
④	II

#### SIZE 15 SHELL



①	15-19
②	19
③	20
④	I

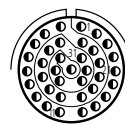

①	15-35
②	37
③	22D
④	M

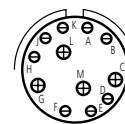

①	15-97
②	4 + 8
③	16 20
④	I

#### SIZE 17 SHELL

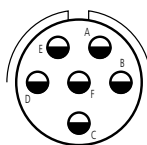

①	17-6
②	6
③	12
④	I

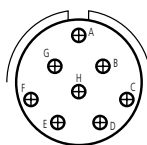

①	17-8
②	8
③	16
④	II

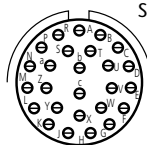

①	17-26
②	26
③	20
④	I

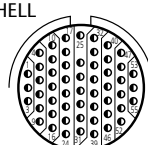

①	17-35
②	55
③	22 D
④	M

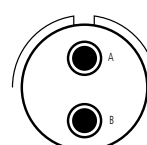

①	17-75
②	2
③	8 TWINAX
④	I

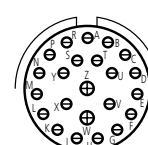

①	17-99
②	2 + 21
③	16 20
④	I

#### SIZE 19 SHELL

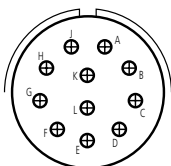

①	19-11
②	11
③	16
④	II

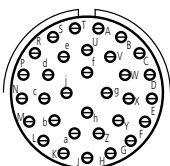

①	19-32
②	32
③	20
④	I

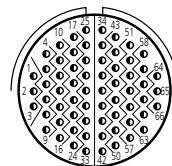

①	19-35
②	66
③	22 D
④	M

#### SIZE 21 SHELL

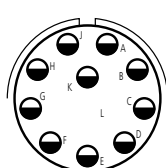

①	21-11
②	11
③	12
④	1

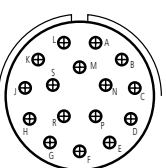

①	21-16
②	16
③	16
④	11

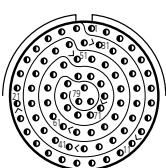

①	21-35
②	79
③	22D
④	M

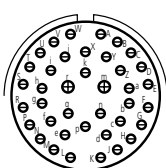

①	21-39
②	2 + 37
③	16 20
④	I

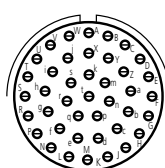

①	21-41
②	41
③	41
④	20

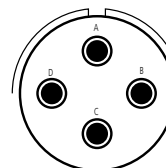

①	21-48
②	4
③	8 Puissance
④	M

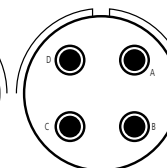

①	21-75
②	4
③	8 Coax
④	I

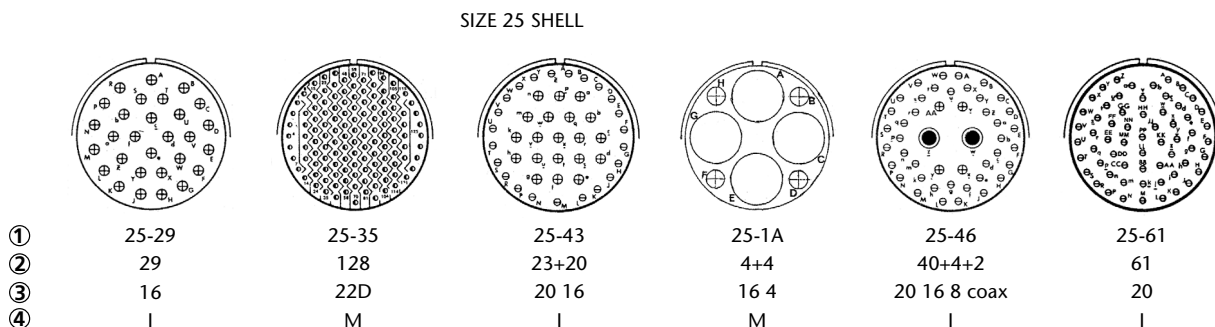
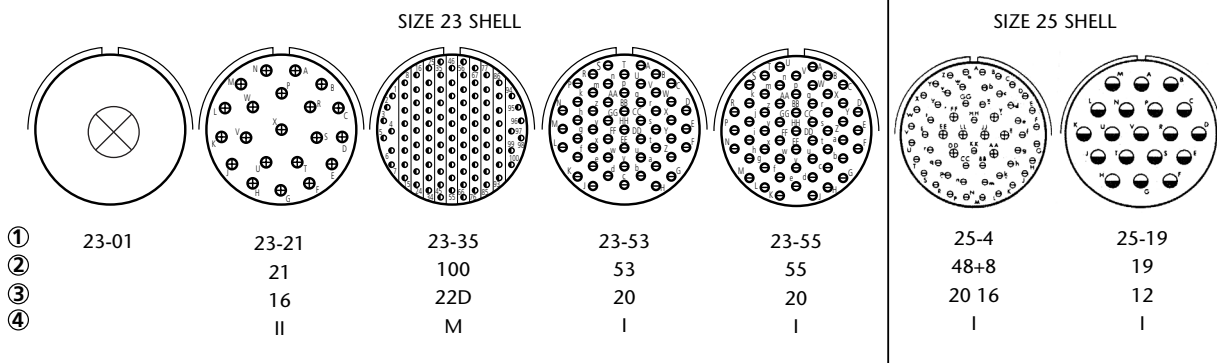

Insert arrangements	Service (see page 3)	Number of contacts	Number of contacts by size							
			22D	20	16 POWER	12 POWER COAX	8 COAX TRIAXIAL	8 POWER	4 POWER	00 POWER
RNJ										
11-2	I	2		2						
11-4	I	4		4						
11-12	II	1				1				
11-35	M	13	13							
11-98	I	6		6						
11-99	I	7		7						
13-4	I	4			4					
13-26	M	8	6			2				
13-35	M	22	22							
13-98	I	10		10						
15-5	II	5			5					
15-19	I	19		19						
15-35	M	37	37							
15-97	I	12		8	4					
17-6	I	6				6				
17-8	II	8			8					
17-26	I	26		26						
17-35	M	55	55							
17-75	I	2				2				
17-99	I	23		21	2					
19-11	II	11			11					
19-32	I	32		32						
19-35	M	66	66							
21-11	I	11				11				
21-16	II	16			16					
21-35	M	79	79							
21-39	I	39		37	2					
21-41	I	41		41						
21-48	I	4						4		
21-75	I	4					4			
23-01		1								1
23-21	II	21			21					
23-35	M	100	100							
23-53	I	53		53						
23-55	I	55		55						
25-4	I	56		48	8					
25-19	I	19				19				
25-29	I	29			29					
25-35	M	128	128							
25-43	I	43		23	20					
25-1A	M	8			4			4		
25-46	I	46		40	4		2			
25-61	I	61		61						

Please consult us for other insert arrangements.

## Overall dimensions

### Receptacle

Jam nut receptacle for both crimp and PCB contacts

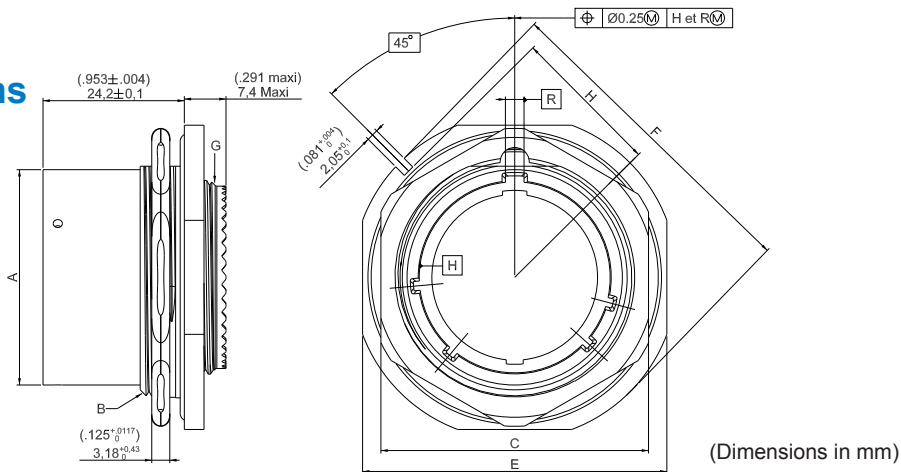

Shell size	Diameter A Max.	Thread B UNEF Class 2A	C Max.	E +0,48 0 (+0.19) 0	Diameter F +0,41 0 (+0.16) 0	Thread G UNEF Class 2A	H 0 -0,2 0 (-0.08)	Mass with contacts (average)	
								Male g	Female g
	mm (inch)		mm (inch)	mm (inch)	mm (inch)		mm (inch)		
11	17,81 (.701)	.8125-20	25,9 (1.020)	31,49 (1.240)	34,93 (1.375)	.5625-24	15,33 (.604)	16	19,5
13	21,62 (.851)	1.000-20	30,7 (1.209)	34,69 (1.366)	38,10 (1.500)	.6875-24	16,92 (.666)	22,5	28
15	24,80 (.976)	1.125-18	33,8 (1.331)	37,79 (1.488)	41,28 (1.625)	.8125-20	18,51 (.729)	28	37
17	27,97 (1.101)	1.250-18	37,0 (1.457)	40,99 (1.614)	44,45 (1.750)	.9375-20	20,10 (.791)	33	46,5
19	30,69 (1.208)	1.375-18	40,2 (1.583)	45,79 (1.803)	49,23 (1.938)	1.0625-18	22,67 (.893)	41,5	58,5
21	33,86 (1.333)	1.500-18	43,4 (1.709)	48,99 (1.929)	52,37 (2.062)	1.1875-18	24,26 (.955)	50,5	71
23	37,04 (1.458)	1.625-18	46,5 (1.831)	52,09 (2.051)	55,58 (2.188)	1.3125-18	25,84 (1.017)	55,50	82,5
25	40,22 (1.583)	1.750-18	51,3 (2.020)	55,29 (2.177)	58,72 (2.312)	1.4375-18	27,43 (1.080)	63	98

### Plug

With rear accessory possibility

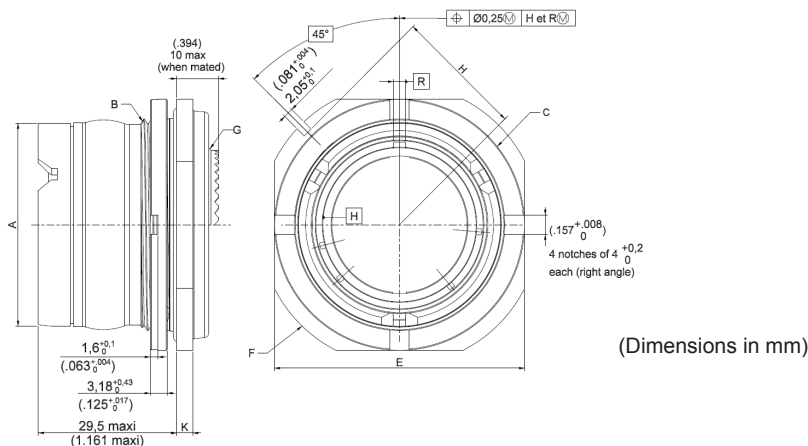

Without rear accessory possibility

Shell size	Diameter A +0,03 -0,1 (+0.01) -0.04	Thread B UNEF Class 2A	C Max.	E 0 -0,25 0 (-0.1)	Diameter F ±0,41 (±0.16)	Thread G UNEF Class 2A	H 0 -0,25 0 (-0.1)	K +0,28 -0,25 (+0.11) -0.1	Mass with contacts (average)	
									Male g	Female g
	mm (inch)		mm (inch)	mm (inch)	mm (inch)		mm (inch)			
11	23,00 (.906)	1.000-20	32,23 (1.264)	32,16 (1.266)	38,10 (1.500)	.5625-24	16,92 (.666)	2,77 (.109)	24	28
13	26,80 (1.055)	1.125-18	35,25 (1.388)	35,34 (1.391)	41,28 (1.625)	.6875-24	18,51 (.729)	2,77 (.109)	28	34
15	30,00 (1.181)	1.250-18	38,40 (1.512)	38,51 (1.516)	44,45 (1.750)	.8125-20	20,10 (.791)	2,77 (.109)	32	41
17	33,22 (1.308)	1.375-18	41,60 (1.638)	41,69 (1.641)	49,23 (1.938)	.9375-20	22,67 (.893)	2,77 (.109)	38	51
19	36,20 (1.425)	1.500-18	46,30 (1.823)	46,43 (1.828)	52,37 (2.062)	1.0625-18	24,26 (.955)	3,56 (.14)	48	65
21	39,40 (1.551)	1.625-18	49,60 (1.953)	49,64 (1.954)	55,58 (2.188)	1.1875-18	25,84 (1.017)	3,56 (.14)	67	87
23	42,60 (1.677)	1.750-18	52,70 (2.075)	52,78 (2.078)	58,72 (2.312)	1.3125-18	27,43 (1.080)	3,56 (.14)	83	111
25	45,68 (1.798)	1.875-16	53,93 (2.213)	54,03 (2.128)	59,10 (2.327)	1.4375-18	27,58 (1.086)	3,56 (.14)	104	125

Only RNJ specific dimensions are mentioned in these figures. -All dimensions which are not mentioned meet the MIL-DTL-38999 Series I Standard.

# Connector mounting

## Generalities

- The dimension of  $36^{+0}_{-0.5}$  between the flanges is mandatory to secure the technical performances at the mating position.
- A guiding system has to ensure the correct positioning of the rack independently of the connectors.
- No mechanical stress must be applied to the rear of the plug by the wires.
- To mount an accessory on the plug, it is necessary to use a holding support to avoid strain on the internal set of the plug.
- A stainless steel pin is delivered with both plug and receptacle connectors. The pin ensures a perfect positioning of the connector on the panel.

## Mated connector

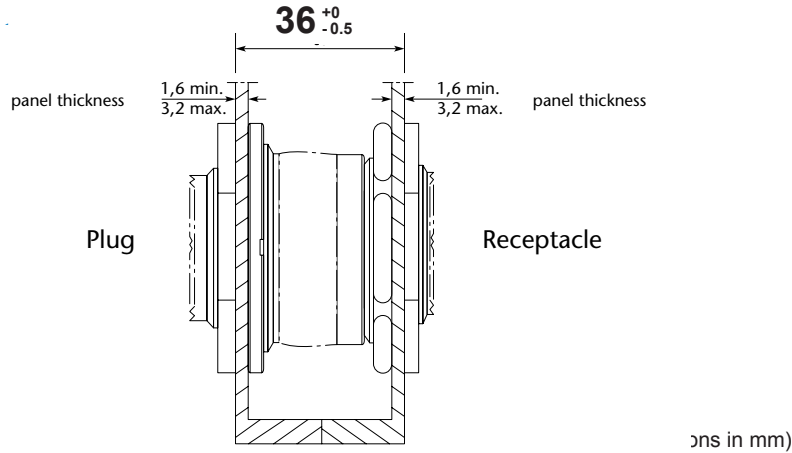

## Panel drilling and recommended nut coupling torque

Shell size		K min mm (in)	W mm (in)	Diam. X +0.1/-0 mm (in)	Nut coupling torque N.m	Clamping bush for RNJ plug
Plug	Receptacle					
—	11	—	11.69 (0.460)	20.,88 (0.822)	4.5/5.7	—
11	13	32.,60 (1.283)	12.81 (0.504)	25.58 (1.007)	6.2/6.8	RNJ 8982 A11
13	15	36.00 (1.417)	13.94 (0.549)	28.80 (1.134)	7.9/8.5	RNJ 8982 B13
15	17	39.60	15.06 (1.559)	31.98 (0.593)	9.0/9.6 (1.259)	RN J8982 C15
17	19	43.30 (1.705)	16.88 (0.665)	35.15 (1.384)	10.2/10.7	RNJ 8982 D17
19	21	47.00 (1.850)	18.00 (0.709)	38.28 (1.507)	11.3/12.4	RNJ 8982 E19
21	23	50.60 (1.992)	19.12 (0.753)	41.50 (1.634)	12.4/13.6	RNJ 8982 F21
23	25	54.20 (2.134)	20.24 (0.797)	44.68 (1.759)	13.6/14.7	RNJ 8982 G23
25	—	59.70 (2.350)	20.30 (0.799)	48.08 (1.893)	15.8/16,9	RNJ 8982 H25

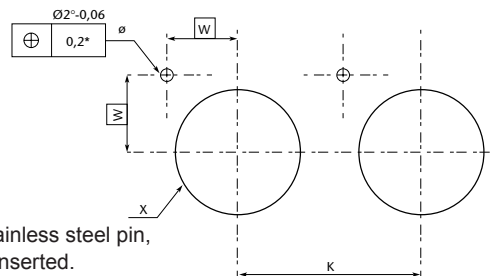

\* Hole to be fitted with a stainless steel pin, which must be forcefully inserted.

## Rear accessories coupling torque

The following values must be respected.  
Before applying this coupling torque, locking glue has to be put on the rear thread of the connector.

Shell size	11	13	15	17	19	21	23	25
Coupling torque (Nm)	8 ± 0.4	11 ± 0.5	11 ± 0.5	14 ± 0.7	14 ± 0.7	17 ± 0.8	17 ± 0.8	20 ± 1



## Standard PCB tail dimensions for RNJ 27 CI receptacles

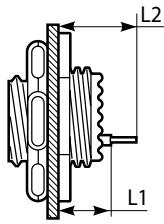

		RNJ 27 CI mm (in)	
P	L1	min	7.89 (0.311)
		max	8.57 (0.337)
L2	min	12.79 (0.504)	
	max	13.67 (0.538)	
S	L1	min	7.69 (0.303)
		max	8.37 (0.330)
L2	min	12.59 (0.496)	
	max	13.47 (0.530)	



(Other dimensions available upon request)  
For specific RNJ 46 plugs equipped with PCB contacts (flex circuit applications), please consult us.

New: RNJ receptacles for PCB applications now available with stand off with holes for M3 screws for fixation on the board.

### How to order

Series	RNJ	26	T	11	35	P	N	014	LC	—
<b>Shell type</b> 26: Plug with accessory possibility 27: Jam nut receptacle 46: Plug without accessory possibility (For plug and receptacle with square flange, please										
<b>Service class and contact type</b> T: Environmental crimp applications, # 22D/20/16/12/8/4/00 CI: Environmental solder applications on PCB (receptacle only), # 22D/20/16 (for sizes 12 and 8, please consult us) DW: Environmental wire-wrapping applications (receptacle only), # 22D/20										
<b>Shell size</b> 11/13/15/17/19/21/23/25										
<b>Insert arrangement</b> See pages 4/5										
<b>Contact style</b> P: Pin S: Socket										
<b>Polarization</b> N: Normal position only (Letter N is required)										
<b>Shell finish</b> 014: Olive drab cadmium 023: Electroless nickel										
<b>Contacts</b> Blank: Connector delivered with contacts LC: Connector delivered without contact ("LC" not marked on the connector)										
<b>Deviation</b> F404: Tinned PCB contacts For other deviations (FXXX), please consult us										

### Clamping bush for RNJ plug



For # 11: RNJ8982A11      For # 19: RNJ8982E19  
 For # 13: RNJ8982B13      For # 21: RNJ8982F21  
 For # 15: RNJ8982C15      For # 23: RNJ8982G23  
 For # 17: RNJ8982D17      For # 25: RNJ8982H25

Do not hesitate to contact us for further information



## Amphenol

Amphenol Socapex  
 Mil/Aero & Industrial Business Unit  
 948, Promenade de l'Arve - BP 29  
 F - 74311 Thyez Cedex  
 Tel.: +33 (0)4 50 89 28 00 - Fax: +33 (0)4 50 96 19 41  
<http://www.amphenol-socapex.com>

Sales office in Paris  
 Tel.: +33 (0)1 49 05 30 00 - Fax: +33 (0)1 49 05 30 43