

This drawing includes confidential information which is the property of ASHCROFT INC. This copy is loaned for a specific purpose, with the understanding that it will not be reproduced or used for any other purpose or disclosed to others, and it will be returned on demand.

ASHCROFT INC.

250 EAST MAIN STREET
STRATFORD, CT 06614

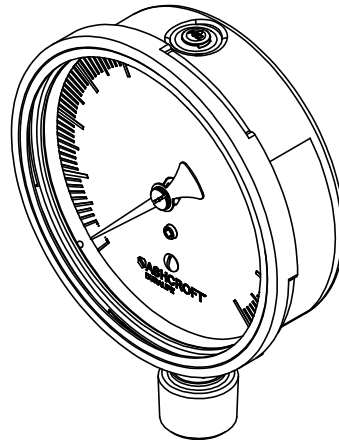
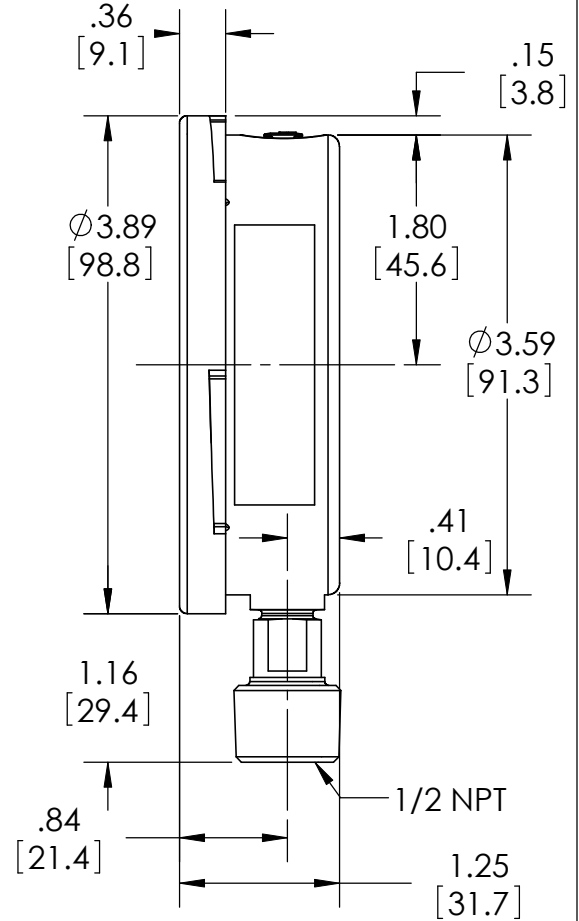
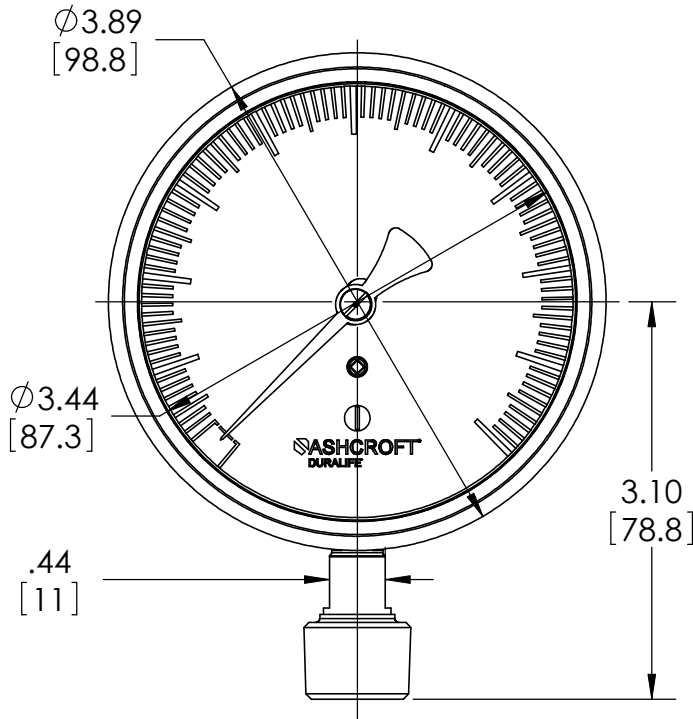

DIMENSIONS IN [] ARE MILLIMETERS

REV.	ECO	DESCRIPTION	BY	DATE
A	0004508	RELEASED GENERAL DIMS. FOR 35 1009 04L	MJS	6/22/2010

This print certified correct for		General Dimensions			
Customer's Name		35 1009 04L SERIES			
		DURALIFE			
Customer's Order No.	Drawn MJS	Date 6/22/10	Date of Issue		
Ashcroft Order No.	Checked	Date	SHEET-1		Rev.
Certified by	Date	Approved	Date	70A3058	A