

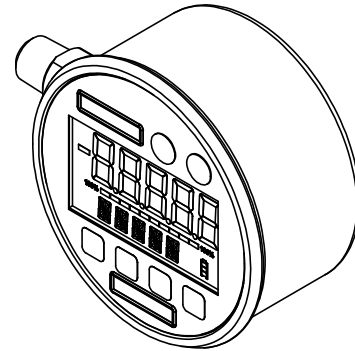

This drawing includes confidential information which is the property of ASHCROFT INC. This copy is loaned for a specific purpose, with the understanding that it will not be reproduced or used for any other purpose or disclosed to others, and it will be returned on demand.

**ASHCROFT** INC.

250 EAST MAIN STREET  
STRATFORD, CT 06614

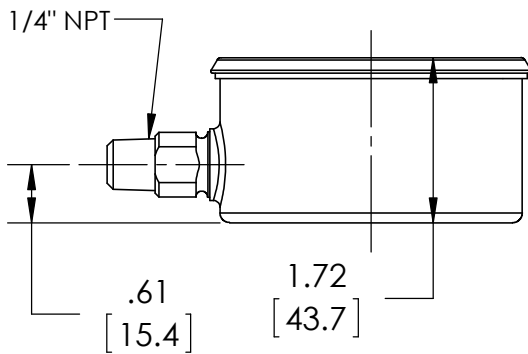
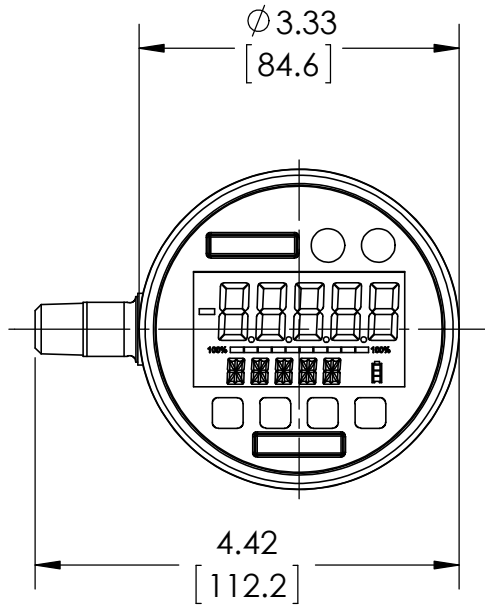

DIMENSIONS IN [ ] ARE MILLIMETERS

REV.	ECO	DESCRIPTION	BY	DATE
A	0005200	RELEASED GENERAL DIMS.	MJS	11/30/2011

This print certified correct for		<b>General Dimensions</b>		
Customer's Name		2074 DIGITAL INDUSTRIAL GAUGE		
		302074SD02E30#		
Customer's Order No.	Drawn MJS	Date 11/30/11	Date of Issue	
Ashcroft Order No.	Checked	Date	SHEET-1	Rev.
Certified by	Date	Approved	Date	<b>70A3886</b>
				<b>A</b>