



Bal Spring[™] canted coil spring

Solutions for EMI/RFI Shielding Applications



Product Innovation Through Engineering Collaboration

At Bal Seal Engineering, we create custom electromagnetic interference/radio-frequency interference (EMI/RFI) shielding solutions that improve the performance and reliability of the equipment you design and manufacture.

For more than half a century, we've helped some of the biggest names in worldwide industry gain a competitive edge. And in many cases, we've helped to develop breakthroughs and shape industry standards along the way. Our collaborative engineering approach enables us to forge "innovation partnerships" with engineers like you who want to make their products stronger, faster, lighter, or more functional.

In early development or existing product improvement stages, we combine our proven core products with application engineering, precision manufacturing and material science expertise to produce solutions that deliver.

The Bal Spring™: A Proven Performer

The Bal Spring canted coil spring is a versatile component that shields sensitive electronics from the harmful effects of EMI/RFI. The spring's independent coils, which serve as multiple contact points for optimal conductivity and/or grounding performance in shielding applications, ensure consistent, reliable connection—even under shock and vibration.

The Bal Spring's highly conductive properties and unique design enable it to provide superior shielding, particularly in high-frequency, small-package applications. It can also be used to mechanically fasten with precisely controllable insertion and removal forces, thereby reducing system complexity and weight.

SHIELDING WITH SPRINGS

Global demand for shielding solutions to address electromagnetic and radio-frequency interference is on the rise due to the need to prevent equipment failure in aerospace, defense, automotive, telecommunications, and many other industries. Shielding from EMI and RFI is vital to preventing damage to critical systems and components.

Bal Spring™ canted coil springs have been tested and proven to provide effective shielding in the packaging of electronic enclosures. As interface components, these springs offer a simple, economical design that greatly reduces radiated and conducted interference. Bal Spring canted coil springs offer additional benefits afforded by their design, including outstanding durability and reliability.

The Bal Spring canted coil spring is available in a variety of sizes and configurations:

- Cross sections range from a coil height (CH) of 0.041 to 0.494 in. (1,04 to 12,55 mm)
- Ring diameters range from 0.020 in. (0,508 mm)
- Base materials include various copper alloys and stainless steel alloys
- Platings with several metals are available
- Forms include precision cut lengths and closed/welded rings

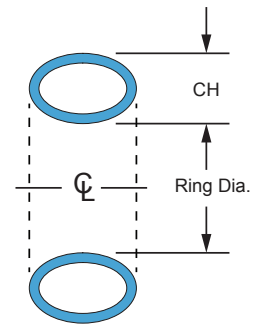

TYPICAL GROOVE CONFIGURATIONS

The following groove configurations, which are the result of extensive design and independent laboratory testing, have been proven to optimize the shielding performance of our Bal Spring canted coil springs. These configurations are readily adaptable to many hardware applications.

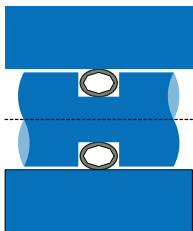

Flat Piston

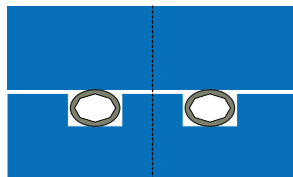

Flat Plate

RECTANGULAR:
Easiest to machine.

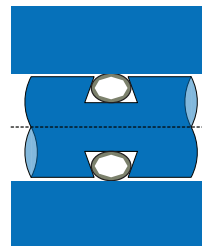

Dovetail Piston

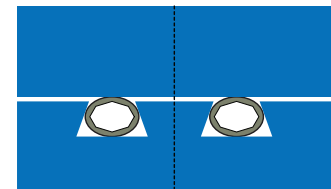

Dovetail Plate

DOVETAIL:
Best for retaining spring in place.

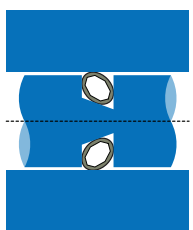

Tapered Piston

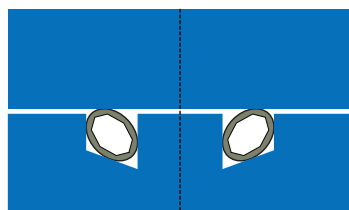

Tapered Plate

TAPERED BOTTOM:
Best control of forces.

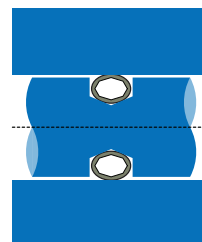

V Piston

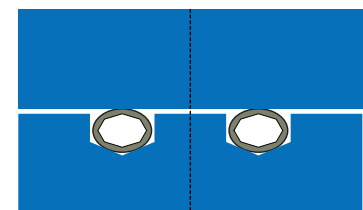

V Plate

V GROOVE:
Best conductivity.

See page 5 for axial and radial load assembly applications.

BENEFITS OF BAL SPRING™ CANTED COIL SPRING DESIGN

Bal Spring™ canted coil springs exhibit a unique deflection and force behavior upon compression. The springs are available as closed rings or straight lengths, in a variety of sizes and materials to meet demanding shielding requirements.

The spring offers long-term durability because of its high resistance to compression set provided by spring resilience. Conductivity across the interface is preserved by highly concentrated forces at multiple contact points. Due to its near constant force over a large compression range, the spring provides consistent shielding despite surface irregularities and tolerance variations (see Figure 1). It is available in very small ring diameters and cross sections, with various groove options, and the spring is self-retained in grooves with no adhesives required. Low compression forces from light spring loads ensure easy assembly. The multi-function spring provides mechanical latching and locking in addition to electrical conducting and EMI/RFI shielding.

CANTED COIL CONFIGURATION

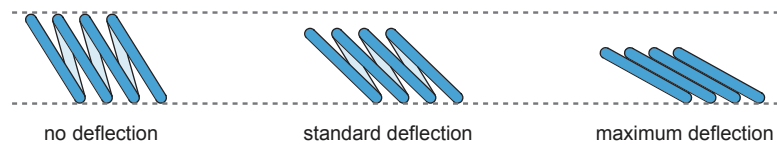

CONSISTENT SHIELDING DESPITE SURFACE IRREGULARITIES AND TOLERANCE VARIATIONS

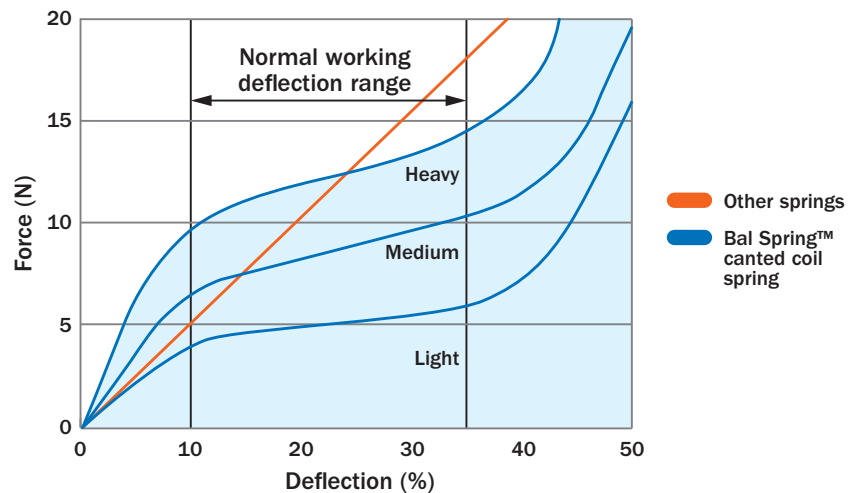
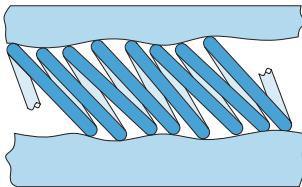

Figure 1. Unlike typical spring technologies, the Bal Spring canted coil spring provides nearly constant force across the working deflection.

EFFECTIVE EMI/RFI SHIELDING

The Bal Spring's highly conductive properties and unique design enable it to provide superior shielding against EMI/RFI, particularly in high-frequency, small-package applications. As an interface shielding component, the spring offers designers a simple, economical means to greatly reduce radiated emissions and conducted interference.

Figure 2 at right indicates the superior shielding effectiveness of the Bal Spring canted coil spring compared with other shielding options. Summary test data shows that the spring exhibits much lower transfer impedance than finger stock, helical flat springs, or wire mesh over elastomer.

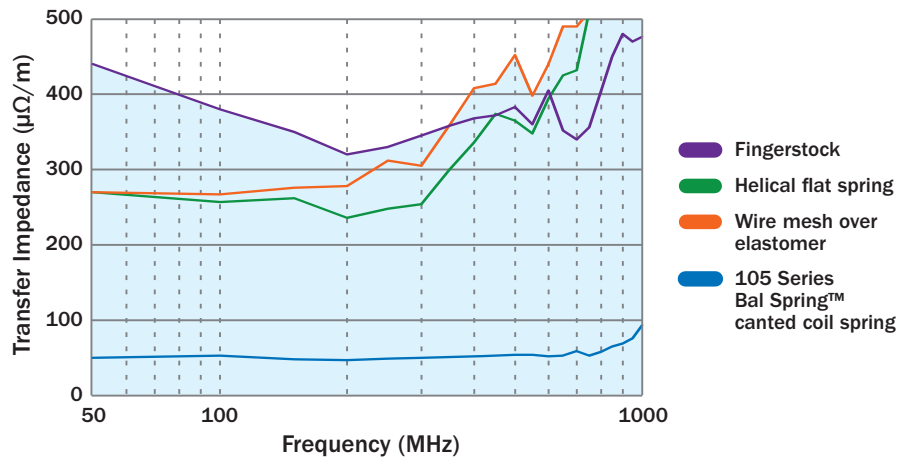

Figure 2. Transfer impedance of canted coil spring vs. other shielding methods.

Figures 3 and 4 at right illustrate the Bal Spring's shielding effectiveness at frequency ranges of 1–10 GHz and 100 MHz–1 GHz. Tests were conducted on a 50-Ω characteristic impedance coaxial connector using a copper alloy Bal Spring with silver plating as a shielding element. The spring was shown to provide up to 90 db of attenuation.

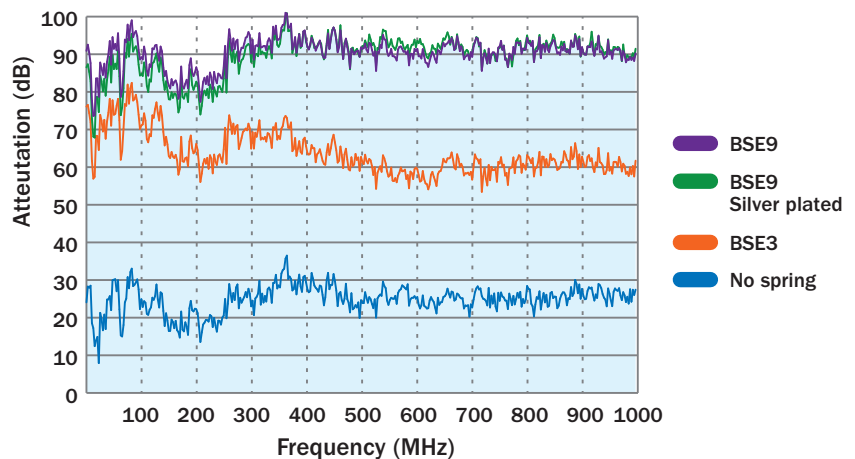

Figure 3. 100 MHz–1 GHz, attenuation vs. frequency.

Compared with no spring, spring material type BSE3 shows greatly improved shielding effectiveness, which may be sufficient for some applications. BSE9, which shows even greater shielding effectiveness, is recommended for high-performance shielding requirements.

Note: shielding effectiveness is highly dependent on connector design and configuration.

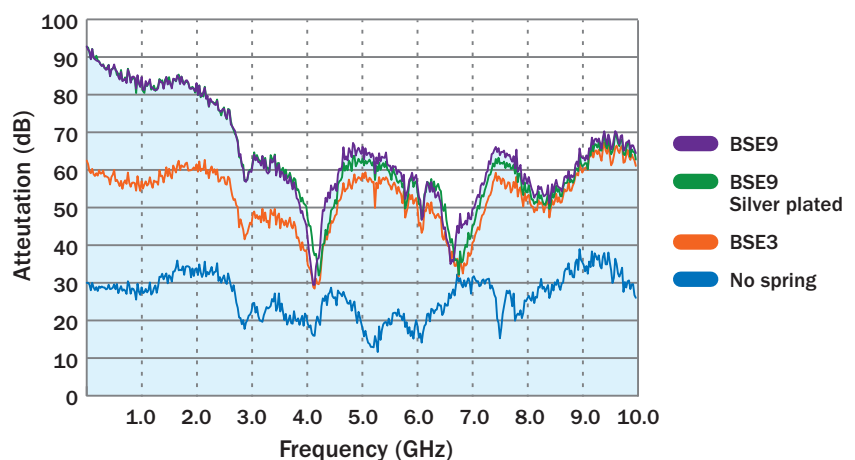

Figure 4. 1–10 GHz, attenuation vs. frequency.

APPLICATIONS

The versatile design of Bal Spring™ canted coil springs allows them to be employed in a variety of applications. The set of typical groove configurations on page 2 optimizes spring performance in various user geometries. The most common assembly orientations are shown below along with a typical example.

AXIAL LOAD ASSEMBLY

For applications involving flat, planar interfaces: The groove may be a linear or closed shape, while the spring may be a free length or ring. The spring is retained in the groove with a light preload during installation and assembly. The mating surface compresses and captivates the spring when assembled. See Figure 5.

TYPICAL AXIAL APPLICATION ELECTRONIC ENCLOSURE

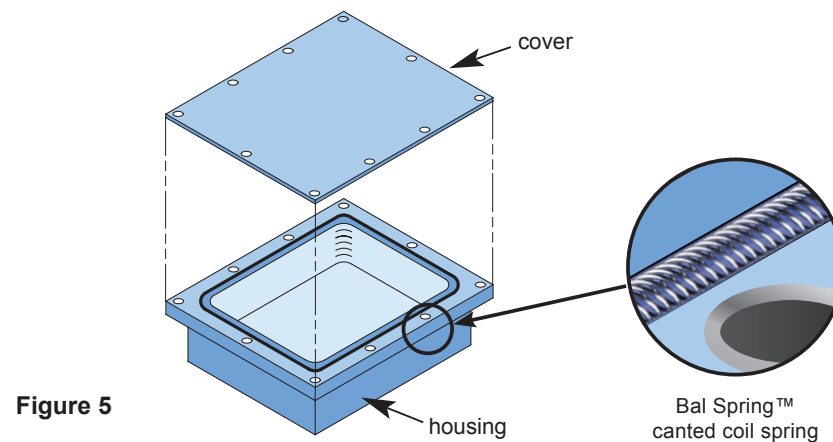

RADIAL LOAD ASSEMBLY

For plug and socket arrangements: The spring in a closed ring form is mounted in the groove on the plug. Coil tension retains the part in the groove through installation. The mating housing compresses and captivates the spring as assembled. See Figure 6.

TYPICAL RADIAL APPLICATION ELECTRICAL CONNECTOR

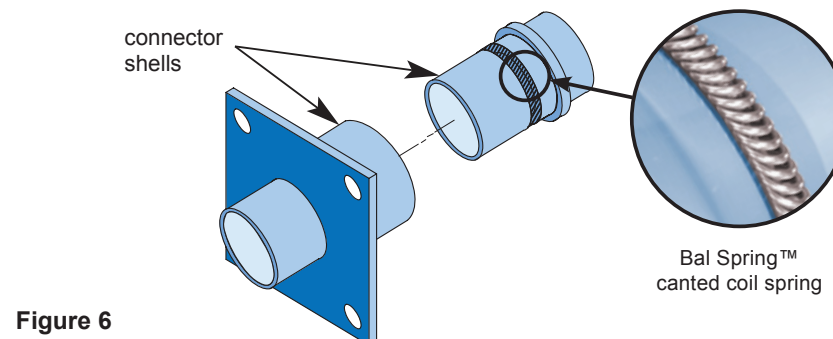

APPLICATIONS

CONNECT/DISCONNECT ASSEMBLY

For applications requiring strong retention or locking between plug and socket parts: The spring is mounted in the groove on the plug. Groove designs on both parts are available for different mating conditions, loading levels, and load sensitive release mechanisms. The mating housing compresses and captivates the spring as assembled. See Figure 7.

TYPICAL CONNECT/DISCONNECT ASSEMBLY

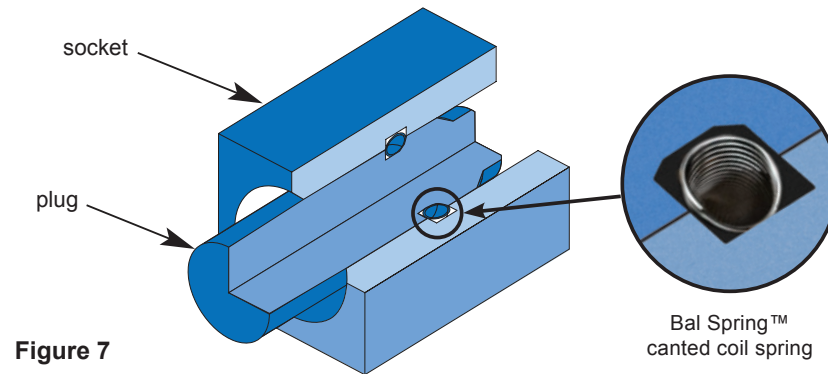

OTHER SAMPLE APPLICATIONS

The spring can be used in a combination of different arrangements. The groove does not have to be rectangular or round; It can follow the shape of the cavity. The interface can be pure axial, radial, or a combination of both. See Figures 8 and 9.

COAXIAL CONNECTOR

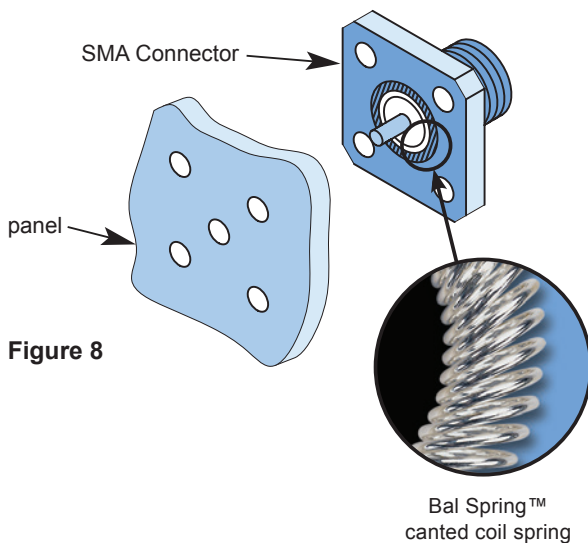

WAVEGUIDE FLANGES

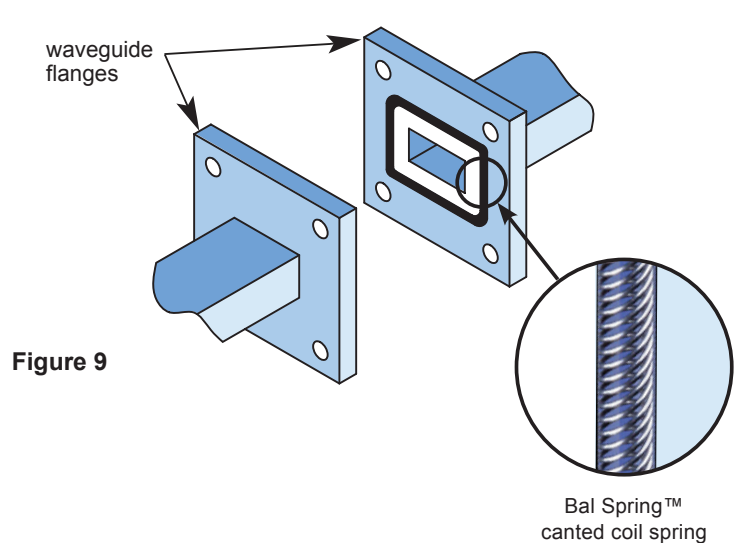

EMI SHIELDING TEST DATA

We maintain a library of data of transfer impedance (Z_T) and shielding effectiveness (SE) measurements for springs. This data is the product of extensive testing to the standards of MIL-G-83528 for shielding effectiveness and SAE ARP 1705 for Transfer Impedance, conducted by an independent test laboratory. We have published a series of Technical Reports covering this subject, including TR-91 "Shielding Quality of Bal Spring™ Canted Coil Springs and Other EMI Gaskets," TR-92 "Shielding Effectiveness of Bal Spring™ Canted Coil springs," and TR-93 "EMI Gasket Test Methods—Transfer Impedance vs. Radiated Shielding Effectiveness." To obtain your copy of these reports, visit the technical library section of our Web site at www.balseal.com.

SPRING SIZING

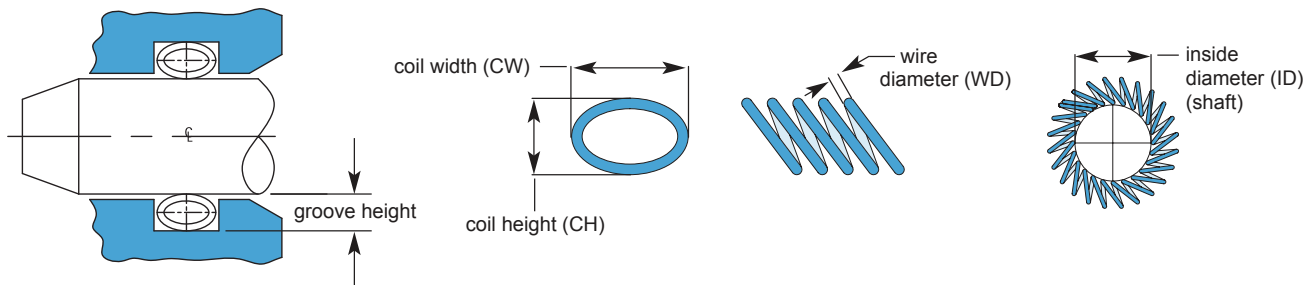

Spring Series*	Nominal Height of Flat Bottomed Groove**	Min. – Max. Coil Width in. (mm)*	Min. – Max. Coil Height in. (mm)	Min. – Max. Wire Diameter in. (mm)	Minimum Ring Inside Diameter in. (mm)
101	0.021	0.016–0.040 (0,41–0,74)	0.016–0.031 (0,41–0,79)	0.003–0.005 (0,08–0,14)	0.020 (0,508)
100	0.043	0.032–0.100 (0,81–2,54)	0.031–0.063 (0,78–1,60)	0.005–0.008 (0,13–0,20)	0.105 (2,67)
104	0.071	0.063–0.121 (1,60–3,07)	0.063–0.094 (1,60–2,39)	0.008–0.014 (0,20–0,36)	0.175 (4,45)
105	0.096	0.095–0.146 (2,41–3,71)	0.094–0.125 (2,39–3,18)	0.011–0.016 (0,28–0,41)	0.230 (5,84)
106	0.138	0.125–0.255 (3,18–6,48)	0.125–0.188 (3,18–4,78)	0.016–0.026 (0,41–0,66)	0.325 (8,26)
107	0.183	0.200–0.419 (5,08–10,64)	0.188–0.250 (3,18–6,35)	0.020–0.031 (0,51–0,79)	0.430 (10,92)
108	0.276	0.253–0.426 (6,43–10,82)	0.250–0.375 (6,35–9,52)	0.026–0.041 (0,66–1,01)	0.650 (16,51)
109	0.384	0.384–0.593 (9,75–15,06)	0.375–0.500 (9,52–12,70)	0.031–0.051 (0,79–1,30)	0.905 (22,99)

NOTE:
PLEASE GIVE CONSIDERATION TO THE FACT THAT THE (Z_T) VALUES PROVIDED THROUGHOUT THIS CATALOG AND OTHER DOCUMENTS ARE THE PRODUCT OF SPECIFIC TEST SAMPLES, HARDWARE, AND PROCEDURES. FOR THESE REASONS, THE DATA MAY BE SUBJECT TO VARIATIONS WITH RESPECT TO OUR USERS' ACTUAL HARDWARE AND IN-USE CONDITIONS. THE ONLY VERIFIABLE METHOD TO DETERMINE THE SHIELDING PERFORMANCE IS THROUGH ACTUAL TESTING OF HARDWARE UNDER REAL OR ACCURATELY SIMULATED OPERATING CONDITIONS.

THE INFORMATION SET FORTH HEREIN IS SOLELY FOR USER'S REFERENCE, AND IS NOT, IN PART OR FULL, TO BE CONSIDERED AS CONSTITUTING A WARRANTY OR REPRESENTATION OF PERFORMANCE FOR WHICH WE WILL ASSUME RESPONSIBILITY.

*OTHER SPRING SIZES AVAILABLE UPON REQUEST.

**EXTREMES IN COIL HEIGHT OR WIDTH REQUIRE CUSTOM GROOVES. CONTACT BAL SEAL ENGINEERING FOR MORE INFORMATION.

SHIELDING PERFORMANCE FOR VARIOUS APPLICATIONS

The following results were compiled from transfer impedance (SAE ARP 1705) measurements taken from over 150 different configurations. Each graph presents its data in terms of a specific parameter—materials and platings, groove types, and forces (See Figures 10–12). The data is averaged for each type within the parameter groupings. Comparative performance between the different types within a graph is expressed in percentage.

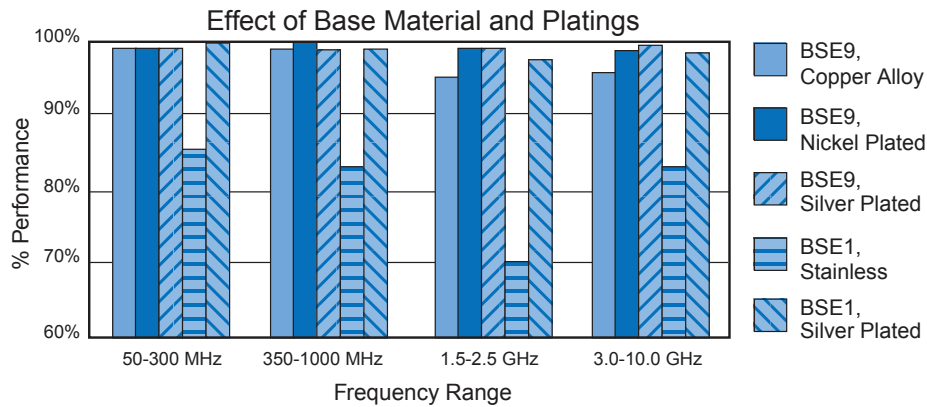

Figure 10. Springs made from stainless steel and copper alloy base materials were plated with nickel and silver. This graph shows their effect on transfer impedance (ZT) measurements.

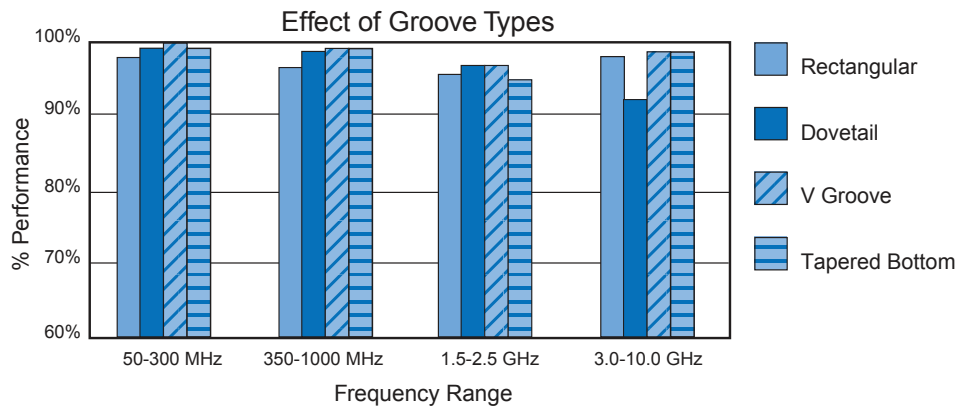

Figure 11. Four groove types were evaluated: rectangular, dovetail, tapered bottom, and V Groove. This graph shows their effect on transfer impedance measurements.

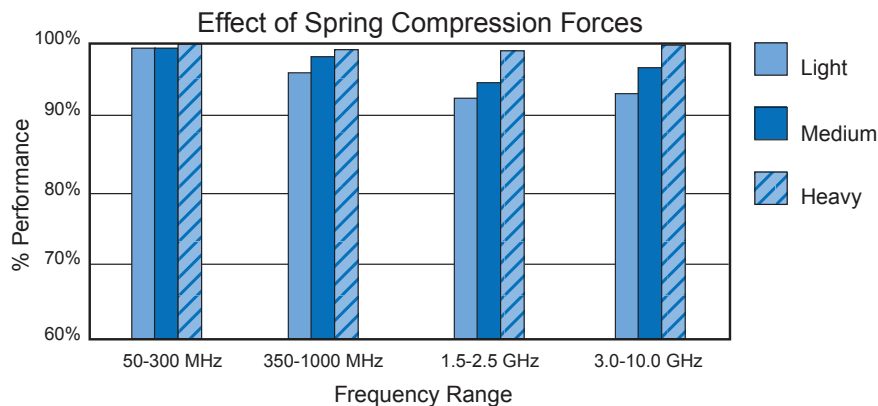

Figure 12. Three different spring forces per size were evaluated: light, medium, and heavy. transfer impedance performance was gained with increased force.

STANDARD MATERIALS

Copper alloy and stainless steel are the standard base materials for Bal Spring™ canted coil springs for EMI shielding. These materials exhibit an excellent combination of mechanical and electrical properties and allow for the manufacture of springs of the highest performance and reliability.

Copper alloy is conductive enough to be used unplated in many applications. Stainless steel will benefit by being plated with a more conductive metal. A spring composed of stainless steel will have a higher force-per-unit compression than one of identical dimensions made from copper alloys.

Material	Conductivity, IACS	Resistivity, $\mu\Omega\text{-cm}$	Comments
BSE9 Copper Alloy	17%	10	High conductivity Susceptible to oxidation
BSE1 Stainless	3%	72	High conductivity when plated Good corrosion resistance
BSE3 Stainless	2.9%	74	High conductivity when plated Excellent corrosion resistance

Table 1. Standard materials.

PLATINGS

Bal Spring canted coil springs are available with platings ideal for use in humid and/or corrosion-inducing environments, or any application in which higher conductivity is desired. The platings may be ordered to MIL standards or other specifications.

Silver plating will generally provide the surfaces of highest conductivity. But, as with all finishes, corrosion potential and wear characteristics must be considered. We routinely use protective coatings on silver plating to provide corrosion resistance.

The galvanic compatibility values in Table 2 are intended as a reference to materials that are in an environment of extreme temperature, humidity, and ionic conductors.

Other materials and platings are available upon request.

Plating Material	Conductivity, IACS	Resistivity, $\mu\Omega\text{-cm}$	Galvanic Compatibility
Gold	74%	2.35	Silver, Titanium, Platinum
Silver	105%	1.59	Nickel, Titanium, AISI 300 steels
Nickel	19%	7.98	Copper, Brass, Beryllium Copper, Tungsten
Tin	15%	11.0	Chromium plating, Aluminum alloys, Galvanized steel series, Brass

Table 2. Conductivity values are percentages of standard copper conductivity. References: *Metals Handbook, American Society for Metals, 1998. TR-85, Galvanic Compatibility for Spring Materials, Bal Seal Engineering, Inc. 2002*

TECHNICAL SUPPORT

Our team of skilled application engineers is standing by to help you tackle your toughest EMI shielding challenges. Just use the online "design request form" at www.balseal.com to provide us with some basic application data, and we'll respond with a detailed design proposal, material choices and more.

IMPORTANT INFORMATION

WARNING

IT IS ESSENTIAL THE END USER RUN EVALUATION TESTING UNDER ACTUAL SERVICE CONDITIONS WITH A SUFFICIENT SAFETY FACTOR TO DETERMINE IF THE PROPOSED, SUPPLIED, OR PURCHASED BAL SEAL PRODUCTS ARE SUITABLE FOR THE INTENDED PURPOSE.

Welded springs have an increased probability of breaking or failing at or adjacent to the weld as opposed to other areas of the spring. This probability is increased further if the spring is used in an application involving extension of the spring. Temperature affects the properties (i.e. tensile strength, elongation, etc.) of the spring. Failure of Bal Seal Engineering, Inc. products can cause greater leakage, equipment failure, property damage, personal injury, and/or death. Equipment containing Bal Seal Engineering products must be designed to provide for the safe handling of any eventuality that may result from a partial or total failure of said Bal Seal Engineering products. Bal Seal Engineering products must be tested with a sufficient safety factor after installation. A program of regular maintenance and inspection must be performed. The user, through their own analysis and testing, is solely responsible for making the final selection of the products and for assuring that all performance, safety, and warning requirements of the application are met.

CLEANING

CUSTOMER/END USER IS ADVISED THAT BAL SEAL ENGINEERING PRODUCTS MAY REQUIRE CLEANING AND/OR STERILIZATION PRIOR TO USAGE, DEPENDING ON THE APPLICATION.

IMPORTANT: DISCLAIMER OF ALL WARRANTIES

THE IMPLIED WARRANTIES OF MERCHANTABILITY AND FITNESS FOR A PARTICULAR PURPOSE AND ALL WARRANTIES, IMPLIED OR EXPRESS, ARE EXCLUDED AND SHALL NOT APPLY TO BAL SEAL OR BAL SEAL ENGINEERING PRODUCTS.

All statements, technical information and recommendations herein are based on tests we believe to be reliable. But the accuracy or completeness thereof is not guaranteed. All such statements, technical information, and recommendations shall not be the basis of any bargain with Bal Seal Engineering or any seller and do not constitute a warrant that the goods will conform to any statements, technical information, or recommendations. The use of any such statement, information or recommendation is solely for the purposes of identification or illustration and is not to be construed as a warranty that any goods will conform to such statements, information, or recommendations. No affirmation of fact or promise made by Bal Seal Engineering or any seller will constitute a warranty that any goods will conform to the affirmation or promise.

Before using any product, the user shall determine the suitability of the product for its intended use, and the user assumes all risk and liability whatsoever in connection therewith. No one,

including company representatives, wholesalers, distributors, salespersons, or employees of Bal Seal Engineering, is authorized to make any warranty or representation, and no customer or user may rely on any warranty or representation. Bal Seal Engineering reserves the right to make any changes without notice in our products and in the information and contents of this document/brochure. Such information can include, but is not limited to, dimensional data, force, torque, materials, pressures, temperatures, surface finishes, etc.

Nothing contained herein or in any of our literature shall be considered a license or recommendation to use any process or to manufacture or to use any product in conflict with existing or future patents, covering any product or material or its use.

The buyer shall hold and save the company, its officers, agents, and employees, harmless from liability of any nature or kind for or on account of the use, sale or lease of any patented or unpatented invention, article, or appliance, furnished or used hereunder.

LIMITATION OF LIABILITY/REMEDIES

IT IS AGREED THAT THE LIABILITY OF THE SELLER AND BAL SEAL ENGINEERING, WHETHER AS A RESULT OF BREACH OF ANY WARRANTY, IF ANY WARRANTY IN FACT BE FOUND TO EXIST, NEGLIGENCE, OTHER TORT, BREACH OF CONTRACT OR OTHERWISE SHALL BE LIMITED TO REPLACING THE NON-CONFORMING BAL SEAL PRODUCT OR ANY PART THEREOF, OR, AT SELLER'S OPTION, TO THE REPAYMENT TO THE BUYER OF THE PURCHASE PRICE PAID BY BUYER IN RESPECT OF WHICH DAMAGES ARE CLAIMED UPON RETURN TO THE SELLER, FREIGHT PREPAID, OF THE NON-CONFORMING PRODUCT OR PART THEREOF. SELLER SHALL NOT BE LIABLE IN TORT OR IN CONTRACT FOR ANY OTHER DAMAGES, DIRECT, INDIRECT OR CONSEQUENTIAL. ANY CLAIMS MUST BE MADE IN WRITING AND WITHIN 28 DAYS OF SHIPMENT OF GOODS TO RECEIVE CONSIDERATION.

Copyright ©2015, Bal Seal Engineering, Inc.

*Products described herein may be protected by one or more of the following U.S. Patents: 5,411,348; 5,474,309; 5,545,842; 5,599,027 and others as well as foreign patents or products where patents are pending.
(LE-88G) (170-3-1) (PR#621-11)

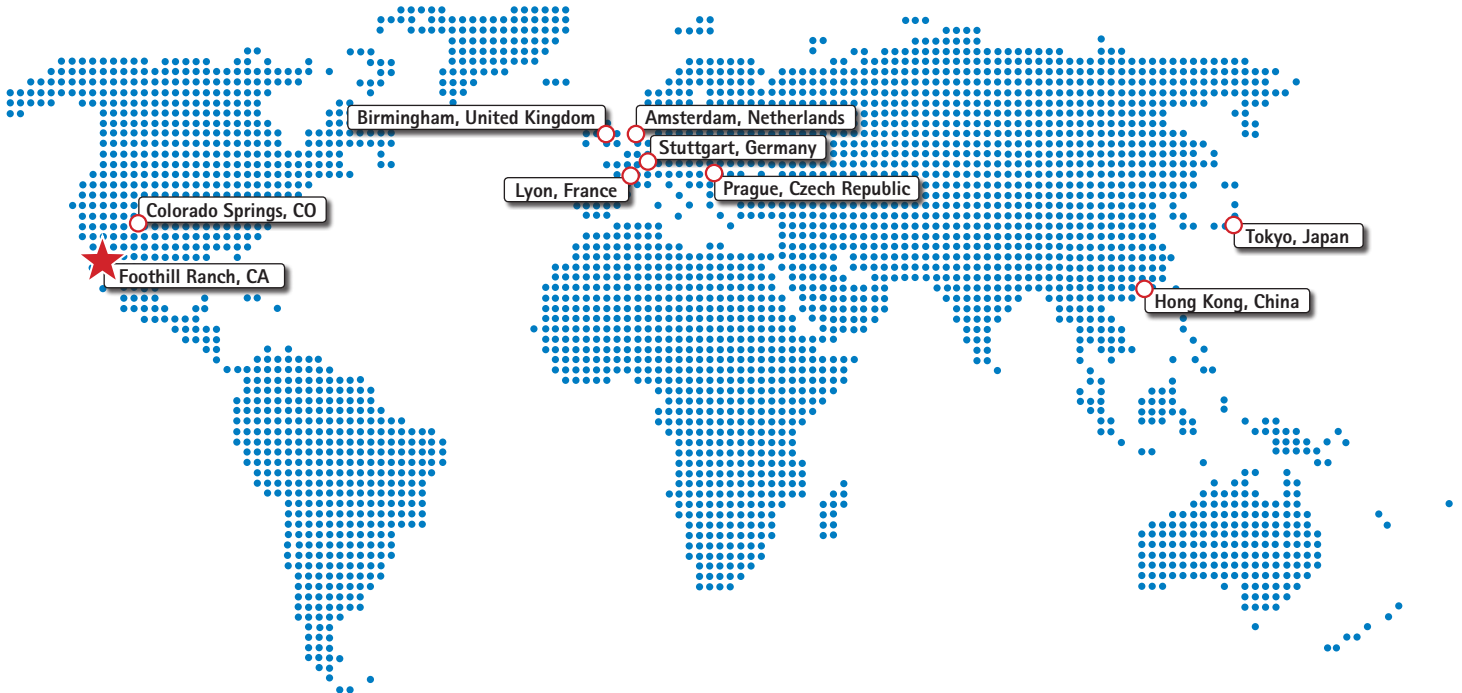

www.balseal.com



Americas

Bal Seal Engineering, Inc.
 19650 Pauling
 Foothill Ranch, CA 92610-2610
 Telephone 949 460 2100
 Toll Free 800 366 1006
 Fax 949 460 2300
 E-mail sales@balseal.com

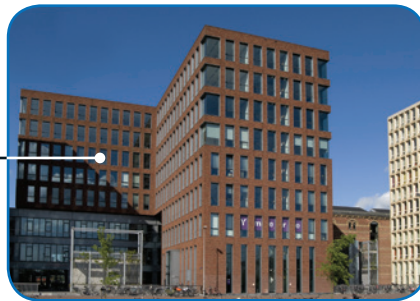

Europe, Middle East, Africa

Bal Seal Engineering Europe B.V.
 Jollemanhof 16, 5th floor
 1019 GW Amsterdam
 The Netherlands
 Telephone +31 20 638 6523
 Fax +31 20 625 6018
 E-mail ordersbv@balseal.nl

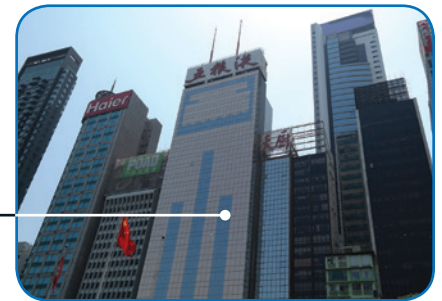

Asia Pacific

Bal Seal Asia Limited
 Suite 901, Chinachem Century Tower
 178 Gloucester Road
 Wanchai, Hong Kong
 Telephone +852 28681860
 Fax +852 22956753
 E-mail sales@balseal.com.hk



Bal Seal Engineering is certified to **ISO 9001** and **ISO/TS16949**