

10/100 Single Port Transformer Modules

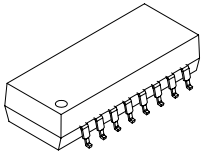

- ★ Designed to meet IEEE802.3u requirement
- ★ Designed to meet IR 235^oC peak requirement
- ★ Primary inductance 350μH min. with 8mA DC Bias
- ★ Single Port for NIC or Hub Application

Specifications										
Part Number	Turn Ratio		Insertion Loss 1~100MHz (dB MAX)	Return Loss (MHz)			CMRR (dB)			Hi-Pot (Vrms MIN)
	Tx	Rx		30MHz	60MHz	80MHz	30MHz	50MHz	100MHz	
HS0011	2:1	1:1	1.0	-20db	-15dB	-12dB	-42db	-40dB	-35dB	1500

Dimension

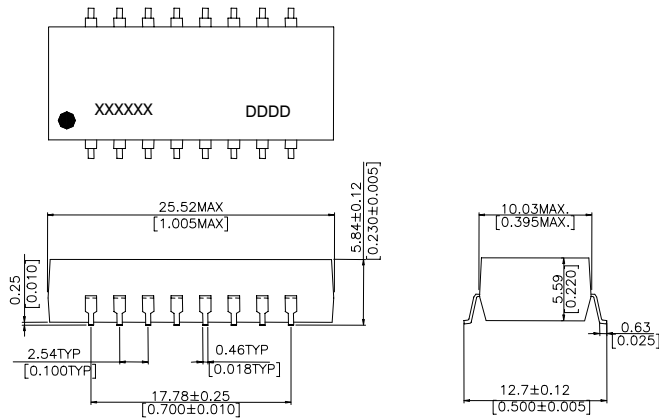

Schematic

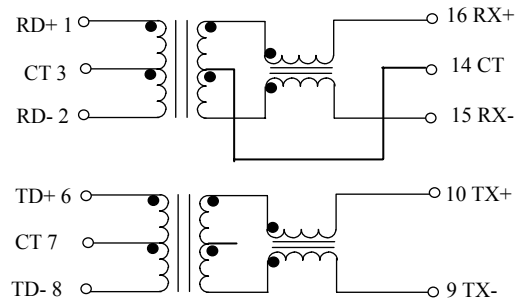

Note: XXXXXX : Part Number

DDDD : Data Code

Data sheet subject to change without notice