

Power

电源连接器



M25 电源连接器

M25 Power

电缆连接器

- M25 螺母锁紧
- 3 - 12 芯
- 防护等级 IP40
- 焊接接线
- 出口直径 28 mm

电缆连接器

- M25 螺母锁紧
- 3 - 12 芯
- 防护等级 IP40
- 焊接接线
- 出口直径 42.5 mm

Cable Connectors

- Screw termination M25
- 3 – 12 contacts
- Degree of protection IP40 ¹⁾
- Solder termination
- Diameter 28 mm

Panel Mount Connectors

- Screw termination M25
- 3 – 12 contacts
- Degree of protection IP40 ¹⁾
- Solder termination
- Diameter 42.5 mm

¹⁾ Erläuterung der Schutzarten siehe technische Informationen./ ¹⁾ Explanation of protection standards see technical information.

电缆连接器，针
Male cable connector

电缆连接器，孔
Female cable connector

图例 / Figure



尺寸图 / Drawing

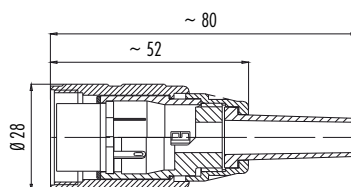
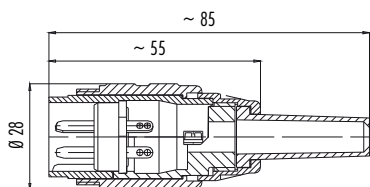

订货信息 / Order Data

芯数 Contacts	电缆出口直径 Cable outlet	订货号 Ordering-No.
3	5-8 mm	09 0033 00 03
5	5-8 mm	09 0037 00 05
7	5-8 mm	09 0041 00 07
12	5-8 mm	09 0445 00 12

芯数 Contacts	电缆出口直径 Cable outlet	订货号 Ordering-No.
3	5-8 mm	09 0034 00 03
5	5-8 mm	09 0038 00 05
7	5-8 mm	09 0042 00 07
12	5-8 mm	09 0446 00 12

技术参数 / Specifications

芯数	3	5	7	12	Number of contacts
锁紧方式	M25螺母锁紧 / screw				Connector locking system
接线方式	焊接 / solder				Termination
导线截面	max. 1,5 mm ² (max. AWG 16)		max. 0,75 mm ² (max. AWG 20)		Wire gauge
电缆出口直径	5-8 mm				Cable outlet
防护等级	IP40				Degree of protection
插拔周期	>500插拔周期 / > 500 mating cycles				Mechanical operation
最高工作温度	+ 85 °C				Upper temperature
最低工作温度	- 40 °C				Lower temperature
额定电压	250 V		125 V		Rated voltage
额定冲击电压	2500 V		1500 V		Rated impulse voltage
污染等级	1				Pollution degree
过电压等级	II				Overvoltage categorie
绝缘等级	III				Material group
额定电流 (40 °C)	10 A		5 A		Rated current (40 °C)
触点电阻	≤ 5 mΩ		≤ 8 mΩ		Contact resistance
插针材料	针 / pin CuZn(黄铜 / brass) 孔 / socket CuSn(青铜 / bronze)				Material of contact
插针表面材料	Ag(银 / silver) 针触点7+12芯 / 7+12 针 CuZnSn(锡锌铜 / optalloy)				Contact plating
插头主体材料	PBT		PET		Material of contact body
外壳材料	GD-A1(阳极氧化 / anodized)				Material of housing

部件图
Component part drawing

电缆连接器，针
Male cable connectors

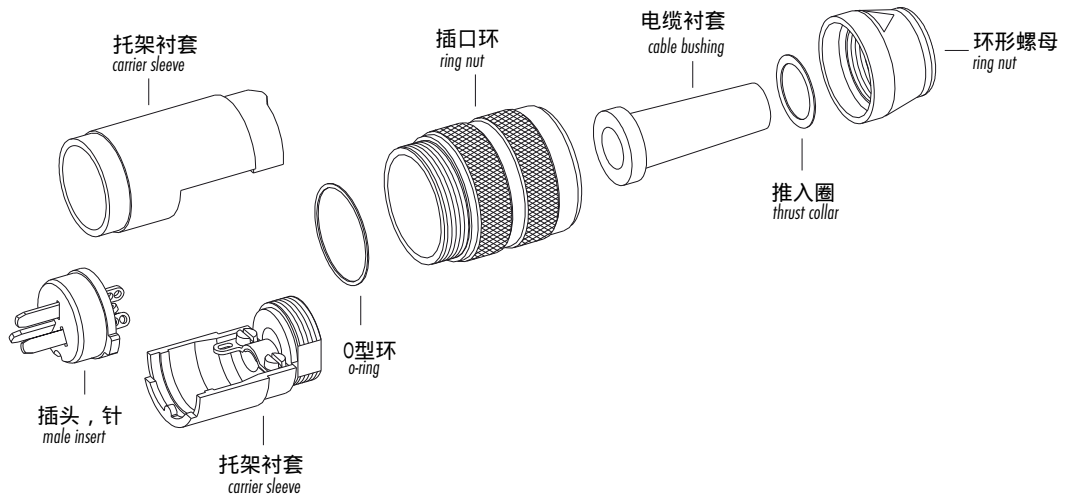

电缆连接器，孔
Male cable connectors

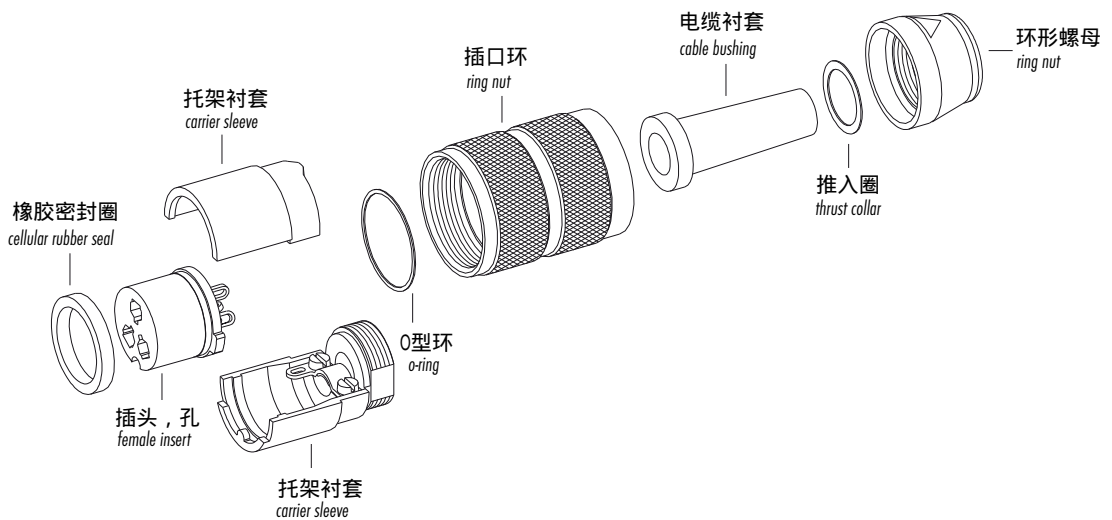

面板安装连接器，针 Male panel mount connector

面板安装连接器，孔 Female panel mount connector

图例 / Figure



尺寸图 / Drawing

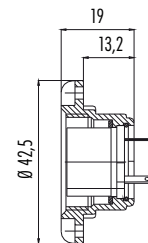
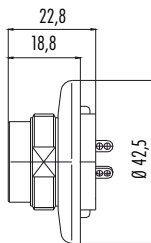

订货信息 / Order Data

芯数 Contacts	订货号 Ordering-No.
3	09 0035 00 03
5	09 0039 00 05
7	09 0043 00 07
12	09 0447 00 12

芯数 Contacts	订货号 Ordering-No.
3	09 0036 00 03
5	09 0040 00 05
7	09 0044 00 07
12	09 0448 00 12

技术参数 / Specifications

芯数	3	5	7	12	Number of contacts
锁紧方式	M25螺母锁紧 / screw				Connector locking system
接线方式	焊接 / solder				Termination
导线截面	max. 1,5 mm ² (max. AWG 16)		max. 0,75 mm ² (max. AWG 20)		Wire gauge
电缆出口直径	—				Cable outlet
防护等级	IP40				Degree of protection
插拔周期	>500插拔周期 / > 500 mating cycles				Mechanical operation
最高工作温度	+ 85 °C				Upper temperature
最低工作温度	- 40 °C				Lower temperature
额定电压	250 V		125 V		Rated voltage
额定冲击电压	2500 V		1500 V		Rated impulse voltage
污染等级	1				Pollution degree
过电压等级	II				Overvoltage categorie
绝缘等级	III				Material group
额定电流 (40 °C)	10 A		5 A		Rated current (40 °C)
触点电阻	≤ 5 mΩ		≤ 8 mΩ		Contact resistance
插针材料	针 / pin CuZn(黄铜 / brass) 孔 / socket CuSn(青铜 / bronze)				Material of contact
插针表面材料	Ag(银 / silver) 针触点 7+12芯 / 7+12 针 CuZnSn(锡锌铜 / optalloy)				Contact plating
插头主体材料	PBT		PET		Material of contact body
外壳材料	GD-A1(阳极氧化 / anodized)				Material of housing

针位图
Contact arrangements

插孔，针（接触面）
Male insert (mating side)

插孔，孔（接触面）
Female insert (mating side)

3芯
3 contacts

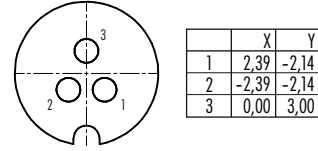
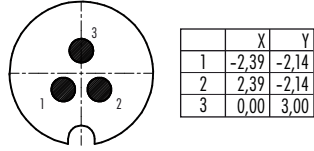

5芯
5 contacts

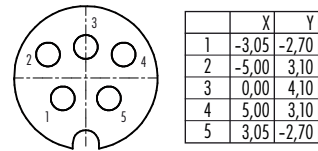
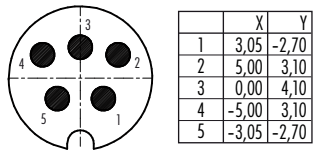

7芯
7 contacts

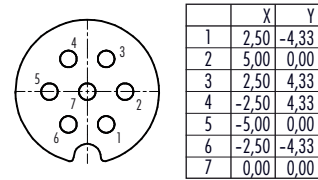
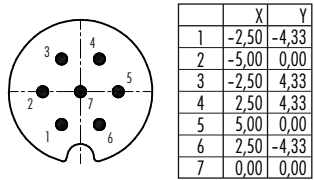

12芯
12 contacts

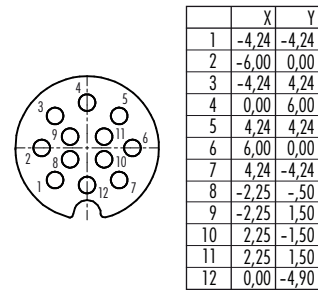
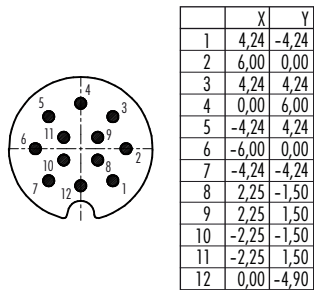

安装截面
Panel cut out

