

Instruction for Use

021387/09/09

Wind Display LED

4.3250.0x.000 with Digital IF

4.3250.0x.xxx with Analogue IF



ADOLF THIES GmbH & Co. KG

Hauptstraße 76 37083 Göttingen Germany
Box 3536 + 3541 37025 Göttingen
Phone +49 551 79001-0 Fax +49 551 79001-65
www.thiesclima.com info@thiesclima.com

Contents

1	Model	4
2	Application	5
3	Display	6
3.1	Wind - Display 1	7
3.2	Wind - Display 2 or 3	7
4	Mode of Operation	7
5	Recommendation for Side Selection	9
6	Installation	9
6.1	Mechanical Mounting	9
6.2	Electrical Mounting	10
6.2.1	Connection of Wind Transmitters with digital Output	11
6.2.1.1	Pin Assignment for Wind Transmitter with digital output	12
6.2.2	Connection of Wind Transmitters with analogue Output	12
6.2.2.1	Pin Assignment for analogue Measuring variable	13
6.2.2.2	Pin Assignment for Voltage Supply of analogue Wind Transmitter.....	13
6.2.3	Analogue output for the Parameters Wind Velocity and Wind Direction.....	13
6.2.3.1	Pin Assignment for analogue Output.....	14
6.2.4	Connecting Serial Interface RS422 / RS485	14
6.2.4.1	Pin Assignment RS422 / RS485	14
6.2.4.2	Interface configuration.....	15
6.2.4.3	Termination	15
6.2.5	Connecting Supply Voltage	16
7	Settings	17
7.1	Setting Mode of Operation	17
7.2	Setting Wind Transmitter Type.....	18
7.3	Setting Data Protocol	19
7.4	Setting Baud rate.....	19
8	Data Protocol	19
9	Operation	22
10	Functional Test	25
11	Error Message	25
12	Maintenance	27
13	Technical Data	28
14	Dimensional Drawing	30
15	EC-Declaration of Conformity	31

Figures

Figure 1: display	6
Figure 2: Back side 4.3250.0x.000	10
Figure 3: Back side 4.3250.0x.1xx / 0xx	10
Figure 4: Example for connection	15
Figure 5: DIP-switch	17
Figure 6: Operation	22

Tables

Table 1: Models	4
Table 2: Wind transmitter connection table	11
Table 3: Data Protocol	19
Table 4: Instrument parameter	24
Table 5: Error messages	26

1 Model

Designation	Order-No.	Meas. value input	Meas. value output	Operating Voltage
Wind Display LED	4.3250.00.000	- WV: Pulse - WD: Serial synchron or - Serial data protocol	Serial data protocol	230 V AC; 24 V AC; 12...35 V DC
Wind Display LED	4.3250.01.000			115 V AC; 24 V AC; 12...35 V DC
Wind Display LED	4.3250.00.140	0... 20 mA	Serial data protocol	230 V AC; 24 V AC; 12...35 V DC
Wind Display LED	4.3250.00.141	4... 20 mA		
Wind Display LED	4.3250.00.161	0... 10 V*		
Wind Display LED	4.3250.00.173	0... 5 V		
Wind Display LED	4.3250.01.140	0... 20 mA	Serial data protocol	115 V AC; 24 V AC; 12...35 V DC
Wind Display LED	4.3250.01.141	4... 20 mA		
Wind Display LED	4.3250.01.161	0... 10 V*		
Wind Display LED	4.3250.01.173	- 0... 5 V		
Wind Display LED	4.3250.00.040	- WV: Pulse - WD: Serial synchron or - Serial data protocol	0... 20 mA Serial data protocol	230 V AC; 24 V AC; 12...35 V DC
Wind Display LED	4.3250.00.041		4... 20 mA Serial data protocol	
Wind Display LED	4.3250.00.061		0... 10 V Serial data protocol	
Wind Display LED	4.3250.00.073		0... 5 V Serial data protocol	
Wind Display LED	4.3250.01.040		0... 20 mA Serial data protocol	115 V AC; 24 V AC; 12...35 V DC
Wind Display LED	4.3250.01.041		4... 20 mA Serial data protocol	
Wind Display LED	4.3250.01.061		0... 10 V Serial data protocol	
Wind Display LED	4.3250.01.073		0... 5 V Serial data protocol	

Table 1: Models

*Attention: The wind transmitters must be supplied externally by voltage > 13 V..

2 Application

With the Wind display LED you are in possession of a modern display device designed for the display of the parameters wind direction and wind velocity. It offers a high level of reliability and flexibility as well as the optimum display of wind parameters.

For the display, coloured light-diodes (LED's) are used, allowing a good readability with various lighting conditions and distances. The brightness is adjustable.

Thanks to an extended dimming function, two different values can be stored as brightness level. This means that individual settings for daytime and night time brightness levels can be called up quickly.

Variants for Processing and Display

- Instantaneous value (ref. chapter 3.1).
- Gliding mean value (ref. chapter 3.2).
- Extreme values (ref. chapter 3.1)

Information:

The calculation is carried out according to the "International Civil Aviation Organisation" (ICAO, Annex 3 - Meteorological Service for International Air Navigation, 1/7/93, chapter 4.5: Observing and reporting of surface wind).

Equipment:

- RS422 / RS 485 interface for the receipt and output for different data protocols (with 4.3250.0x.000 / 040 / 041 / 061 / 073).
In the „Master / Slave“ – operation up to 10 other wind display LED can be connected via a distance up to 1000 m.
- Wind interface for the connection of different wind transmitters with digital output (with 4.3250.0x.00)
- Analogue interface for the connection of wind transmitter with analogue output (with 4.3250.0x.1xx)
- Analogue outputs for the parameter wind velocity and wind direction (with 4.3250.0x.040 / 041 / 061 / 073)
- Selectable power supply for the wind display of 230VAC (optionally 115VAC) or 24VAC / 12 - 35V DC (with 4.3250.0x.000 / 1xx / 0xx)
- Supply voltage for wind transmitter with analogue output (with 4.3250.0x.1xx)
- Operation via key button on the front side (with 4.3250.0x.000 / 1xx / 0xx).
Via a terminal clamp on the back side an external key button can be connected for remote operation.

3 Display

Wind speed (WS):

The wind speed is indicated as instantaneous value/mean value on the red 3-digits-LED-display.

Two additional LED-displays indicate the extreme values (WS-max., and WS-min.) of the wind speed.

The units of measurements are m/s, km/h, kn and Beaufort. A red lighting LED indicates the selected unit of measurement.

Wind direction (WD):

72 rectangular LED's are arranged in a circle to display the wind direction and its variation.

The wind direction is displayed by a red LED in a range from 0...355 ° in steps of 5 increments.

The variation of the wind direction is displayed by a green LED-band.

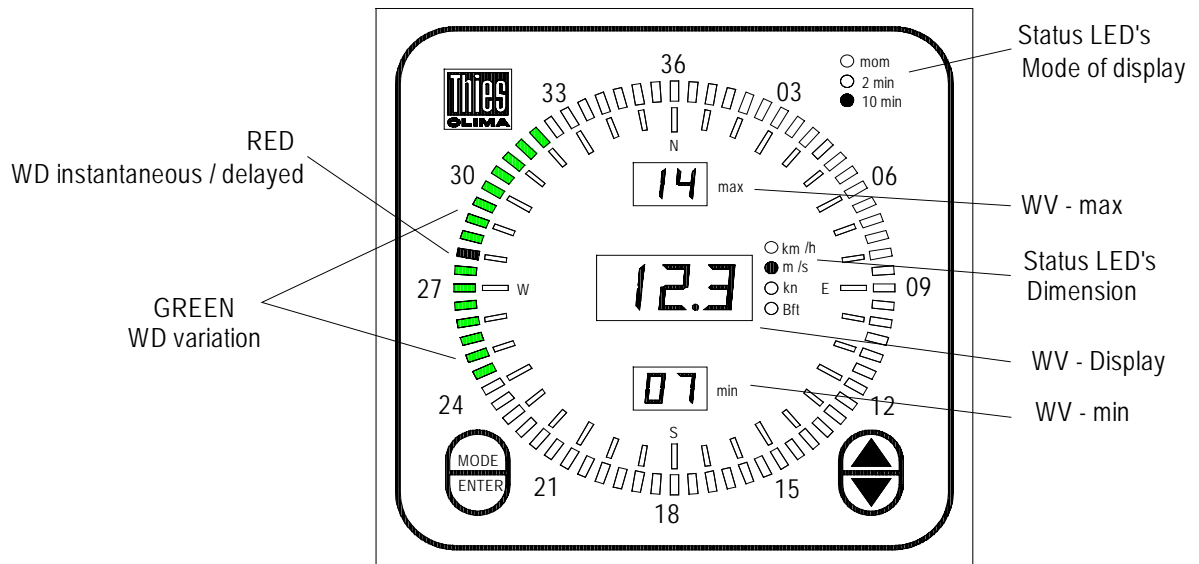

Figure 1: display

3.1 Wind - Display 1

The status LED “mom” lights up. The wind speed is displayed as instantaneous value, and the wind direction as delayed value (factory setting).

Displaying the wind direction is possible in four different variants by selecting another operating mode (ref. chapter 7.1).

1. Setting „WD instantaneous“ displays the instantaneous wind direction.
2. Setting “WD delayed” displays the delayed wind direction: The delay is based on an e-function ($T = 6 \text{ sec}$).
3. Setting “WD instantaneous & variation” displays the instantaneous wind direction as well as the variation. Here, the band of variation ascends in accordance with the instantaneous value of the wind direction. The descending of the variation band is done in a time interval of 1 second in 5° -increments.
4. Setting “WD delayed & variation” displays the delayed wind direction as well as the variation. Here, the band of variation ascends in accordance with the delayed wind direction. The descending of the “variation band” is done in a time interval of 1 second in 5° -increments.

The LED-displays WS-min and WS-max indicate the extreme values of the wind speed since the last reset.

The reset, and consequently the start of a new extreme-value-acquisition is carried out by pressing the ENTER-button.

3.2 Wind - Display 2 or 3

The status LED „2min“ or „10min“ lights up. The available wind values are displayed as gliding mean values, and extreme values of 2 min. or 10 min.

The gliding mean values are calculated every second in consideration of the discontinuity. By this, both mean values are constantly available, and can be displayed on request by respective selection.

4 Mode of Operation

Calculation of the gliding mean value.

Wind Speed (WS)

The gliding mean values are calculated from the number of second-values in a memory. The oldest value is subtracted from the gliding sum and the new value is added. Afterwards, the gliding sum is divided by the number of values.

$$WS_{avg} = \frac{1}{n} \cdot \left(\sum_{i=1}^n WS_i - WS_{old} + WS_{new} \right) \quad \begin{array}{l} n = 120 \text{ (2 min)} \\ \text{or} \\ n = 600 \text{ (10 min)} \end{array}$$

Wind Direction (WD)

The mean value of the wind direction is calculated vectorally by dividing it into X- and Y-components, as the values of the wind directions refer to a circle (0...359°), and the “discontinuity” (the discontinuity between 359° and 0° and vice versa) must be taken into consideration.

The following method serves for the calculation of the gliding vectorial mean value of the wind direction:

The instantaneous values of the wind direction (WD) are transformed from polar coordinates (vector with uniform length 1) into Cartesian coordinates X and Y:

$$\begin{aligned} X_i &= \sin(WD_i) \\ Y_i &= \cos(WD_i) \end{aligned}$$

The gliding mean values of both coordinates are formed from the number of the calculated values. The oldest value is subtracted from the gliding sum, the new value is added. Then, this sum is divided by the number of values per mean-value-time.

$$\begin{aligned} X_{avg} &= \frac{1}{n} \cdot \left(\sum_{i=1}^n X_i - X_{old} + X_{new} \right) \\ Y_{avg} &= \frac{1}{n} \cdot \left(\sum_{i=1}^n Y_i - Y_{old} + Y_{new} \right) \end{aligned} \quad \begin{array}{l} n = 120 \text{ (2 min)} \\ \text{or} \end{array}$$

After the calculation of the mean value the values are transformed into the polar-coordinate-system.

$$WD_{avg} = \arctan \left(\frac{X_{avg}}{Y_{avg}} \right)$$

Calculation of the Extreme Values

The gliding extreme values are calculated every second for both wind parameters. Extreme values are both the lowest and highest instantaneous values within a period of measurement. The period of measurement is either 2 minutes or 10 minutes. The values of both measurement periods are calculated constantly, and can be displayed immediately after selection of display mode (ref. chapter 3.2).

Discontinuity

The discontinuity is taken into consideration when calculating the 10-minutes-mean values and the 10-minutes-extreme values. The calculation is based on the recommendation of the "International Civil Aviation Organisation" (ICAO, Annex 3 - *Meteorological Service for International Air Navigation*, 1/7/93, section 4.5: *Observing and reporting of surface wind*).

Determination of Discontinuity:

1. The difference between the 2-minutes-mean values and 10-minutes mean values is higher than 30° in case that, at least, one of both mean values of the wind speed (2-minutes value or 10-minutes value) is higher than 5.5 m/s (\approx 20 km/h).
2. The difference between both mean values (2-minutes value and 10-minutes value) of the wind speed is higher than 5.5 m/s (\approx 20 km/h).

In case of discontinuity, the 10-minutes-mean values, and the 10-minutes-extreme values are re-calculated, starting from the moment when the discontinuity occurs. First, the 10-minutes values correspond to the 2-minutes value until , after 8 minutes, the 10-minutes values can be calculated again over the total period.

5 Recommendation for Side Selection

The device is designed for inside installation. If used outside, an additional external housing including the appropriate type of protection is necessary.

Remark:

Please pay attention to the recommended temperature range when selecting a side.

6 Installation

Attention:

The instrument must be mounted and wired only by a qualified expert, who knows and observes the generalities of technics, and applicable regulations and norms.

Comment:

Before installation, the settings of the instrument are possibly to be changed (ref. chapter 7).

6.1 Mechanical Mounting

The Wind display LED is designed for installation in a control panel. The necessary control panel opening must be 138 x 138 mm in size. The scope of supply includes two fixing brackets. After the device has been inserted in the control panel, the fixing brackets are slid into the housing at the rear and screwed into place.

6.2 Electrical Mounting

All connections are on the back side (ref. figure 2 and 3).

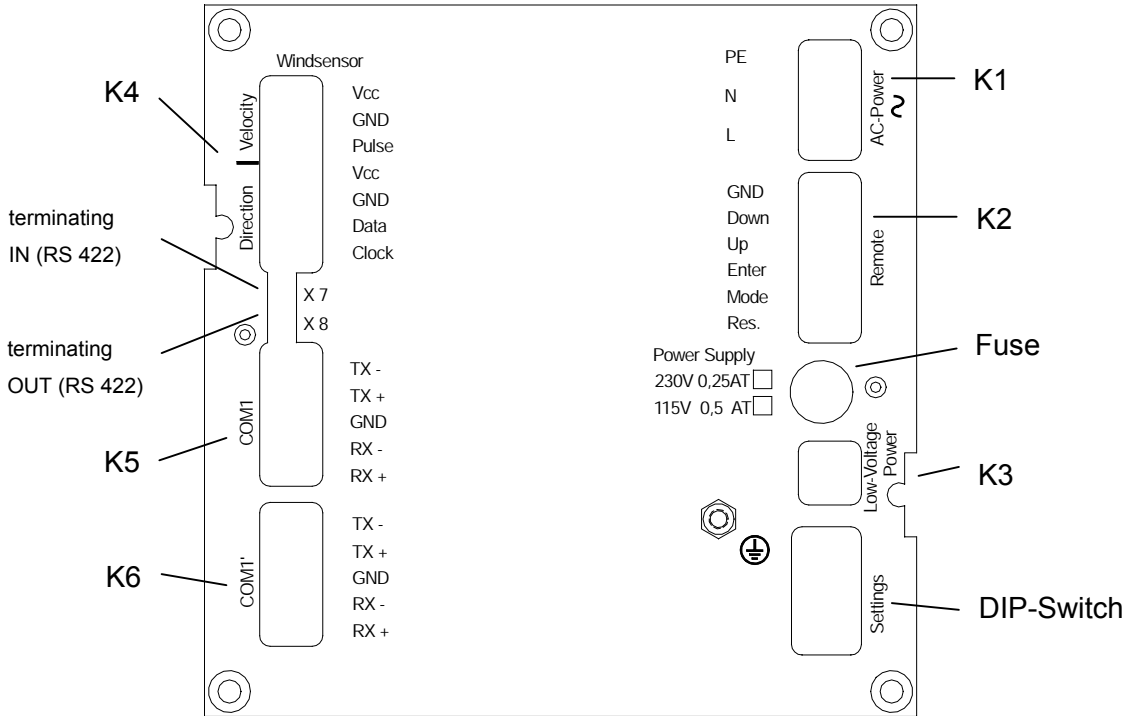
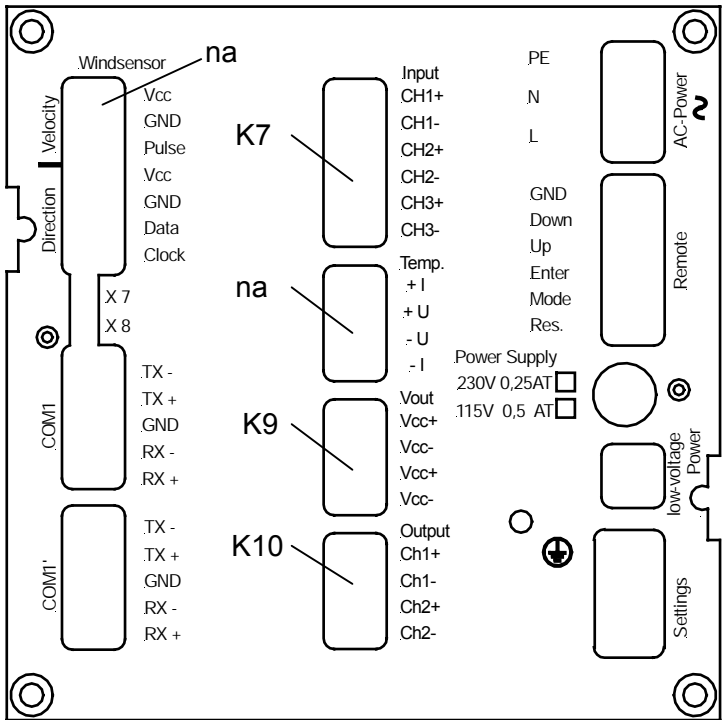

Figure 2: Back side 4.3250.0x.000



- na = not active at 4.3250.0x.1xx

Figure 3: Back side 4.3250.0x.1xx / 0xx

6.2.1 Connection of Wind Transmitters with digital Output

- For connection of wind transmitters : Type Classic, Compact, First-Class (ref. **Table 2**).

Transmitter	Signal / PIN						
	Vcc (WS)	GND	Pulse (WS)	Vcc (WD)	GND	DATA (WD)	CLOCK (WD)
4.3336.21.000 4.3336.31.000 4.3336.21.001 4.3336.21.008 4.3336.31.008	1	2	3	4	---	6	5
4.3336.22.000 4.3336.22.001 4.3336.22.008 4.3336.32.000 4.3336.32.001 4.3336.32.008	1	2	3	4	---	6	5
4.3129.00.000	---	---	---	1	2	3	4
4.3129.60.000	---	---	---	1	2	3	4
4.3519.03.000	1	2	3	---	---	---	---
4.3303.22.000	1	2	3	---	---	---	---
4.3303.22.007	1	2	3	---	---	---	---
4.3303.22.008	1	2	3	---	---	---	---
4.3303.22.018	1	2	3	---	---	---	---
4.3125.32.100 4.3125.32.101	---	---	---	1	2	3	4
4.3125.33.100 4.3125.33.101	---	---	---	1	2	3	4
4.3351.00.000 4.3351.10.000	3	2	1	---	---	---	---
4.3150.00.000 4.3150.10.000	---	---	---	3	2	5	4

Table 2: Wind transmitter connection table

6.2.1.1 Pin Assignment for Wind Transmitter with digital output

The wind transmitters are connected to the clamping plug “Windsensor” (K4). When performing connection make sure that pairing of the wind transmitter types (direction and speed) is carried out according to chapter 7.2 (Wind transmitter type).

Description	Clamping Plug (K4): Windsensor
Vcc	Velocity
GND	
Pulse	
Vcc	Direction
GND	
Data	
Clock	

6.2.2 Connection of Wind Transmitters with analogue Output

There are diverse current and voltage inputs available (see **Model** chapter 1) for the connection of wind transmitters with analogue output.

The wind transmitters must be connected always by pairs, and have to deliver the same output (for ex. wind velocity: 4...20 mA, wind direction: 4...20 mA)

Activation of the analogue inputs is done via the MODE button on the front side, and the menu “**Setting the analogue in/output**” (see chapter 9)

The selection of measuring range (for ex. 50 m/s = 20 mA) is carried out on the front side via the MODE-button and the menu “WV measuring range selection” (see **Operation** chapter 9).

The following inputs measuring ranges are available (adjustable at Mode 4):

Meas. range
40m/s
50m/s
60m/s
75m/s

Remark:

The analogue outputs are active 10 sec after turning on the wind display or after pressing the reset button.

The error detection for the analogue inputs is carried out acc. To the following criterions:

- Voltage input:
Exceeding of measuring range causes error message (for ex. $U(\text{in}) > 10\text{V}$)
- Input not connected causes error message
- Current input:
Exceeding of measuring range causes error message (for ex. $4\text{mA} < I(\text{in}) > 20\text{mA}$)

6.2.2.1 Pin Assignment for analogue Measuring variable

Description	Clamp connector: Input (K7) (WV. WD)
CH1+	Wind velocity
CH1-	Wind velocity
CH2+	Wind direction
CH2-	Wind direction
CH3+	-----
CH3-	-----

6.2.2.2 Pin Assignment for Voltage Supply of analogue Wind Transmitter

Description	Clamp connector: Vout (K9) Vcc (Wind transmitter)
Vcc+	12V Wind direction
Vcc-	12V Wind direction
Vcc+	12V Wind velocity
Vcc-	12V Wind velocity

6.2.3 Analogue output for the Parameters Wind Velocity and Wind Direction

Depending on the model (see **Model** chapter 1). The wind display has power- and voltage outputs in pairs.

Activation of the analogue inputs is done via the MODE button on the front side, and the menu “**Setting the analogue in/output**” (see chapter 9)

The scaling of the output measuring range of the wind velocity is carried out individually via the MODE button on the front side and the menu „WV measuring range selection“ (see **Operation** chapter 9).

The following measuring ranges are available (selectable in Mode 4):

Measuring range
40m/s
50m/s
60m/s
75m/s

In case of error the respective output is set to minimum.

6.2.3.1 Pin Assignment for analogue Output

Description	Clamping plug: Output (K10) (WV. WD)
CH1+	Wind velocity
CH1-	Wind velocity
CH2+	Wind direction
CH2-	Wind direction

6.2.4 Connecting Serial Interface RS422 / RS485

- For wind transmitters with serial data transmission (Ultrasonic- Anemometer 4.38xx...., Wind Direction Transmitter First Class 4.3150.x0.400) or data acquisition or transmission systems.

6.2.4.1 Pin Assignment RS422 / RS485

The clamping plugs "COM1/COM1'" (K5/K6) are used for connection. The two interface clamping plugs are connected in parallel.

Des.	Clamping plug (K5) COM1	Clamping plug (K6) COM1'
TX - (RX-)	transmitter (receiver)	transmitter (receiver)
TX+ (RX+)		
GND	ground	ground
RX-	receiver	receiver
RX+		

6.2.4.2 Interface configuration

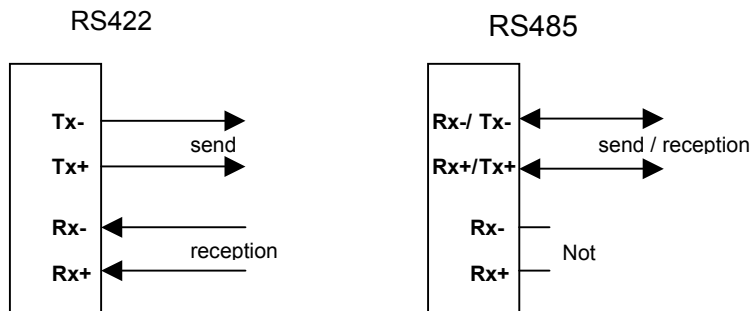

The selection of the interface configuration is carried out via the key mode (see 9 „operation“). In the operation mode RS485 the output of the requirement protocol is carried out cyclically for the VDT-telegram from the ultrasonic.

6.2.4.3 Termination

For termination using long cables the rear of the wind display is equipped with contact pins X7, which can be bridged from outside using a jumper if required (ref. figure 4).

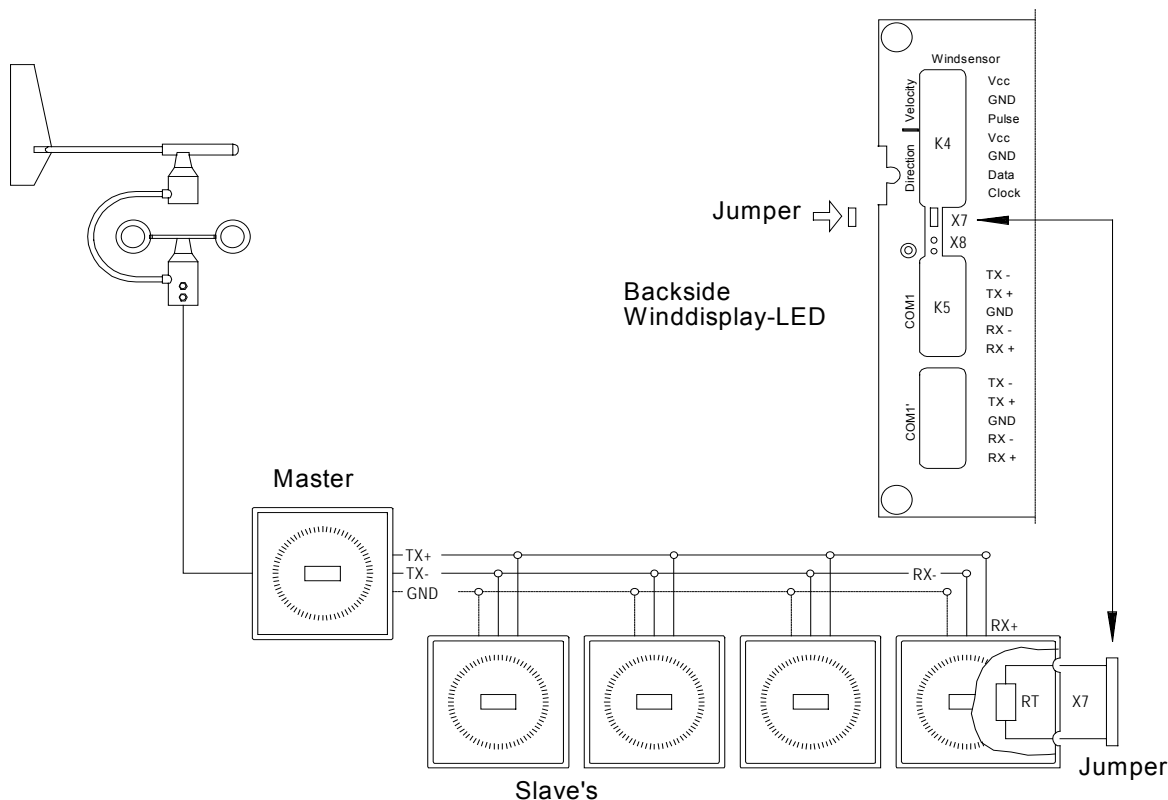

Figure 4: Example for connection

Notes for RS422 / RS485:

Faults on long cables may affect serial transmission, with the serial interface even being destroyed by over-voltages. We therefore recommend:

- The transmission line should be shielded. The shield must be connected to a central earth potential.
- With cable connections longer than 100 m twisted pairs should be used for the signal lines +RX/-RX and +TX/-TX.
- The ground pins (GND) should also be connected in addition to the twisted signal lines. If major differences in potential between the transmitter and receiver result in excessive compensating currents, isolating interface adapters have to be used.
- The cable must always be terminated with its surge impedance. An impedance of 100 Ω to 600 Ω at the receiver is suitable for this purpose (depending on the cable). With more than one receiving Winddisplay LEDs (Slaves) the resistor must be located at the receiver furthest from the transmitter.
- When a jumper (X7) is inserted at the receiver (Slave) the integrated termination resistor (RT=200 Ω) is activated (ref. figure 4).

6.2.5 Connecting Supply Voltage

Connection Wind Display **4.3250.00.xxx**

Designation	Clamping Plug (K1) AC Power
PE	Protective conductor
N	230V AC
L	230V AC

or

Des.	Clamping Plug (K3) low voltage Power
1	24V AC/DC*
2	24V AC/DC*

Connection Wind Display **4.3250.01.xxx**

Designation	Clamping Plug (K1) AC Power
PE	Protective conductor
N	115V AC
L	115V AC

or

Des.	Clamping Plug (K3) low voltage Power
1	24V AC/DC*
2	24V AC/DC*

* ref. chapter 13

7 Settings

On the rear of the device there is a **8-fold DIP switch (S1...S8)** for the basic setting of different parameters (ref. **Figure 2 / Figure 3**)

Remark:

A restart has to be carried out after any change in the switch position. Restart is performed by activating the "Info Reset" button or interrupting the power supply.

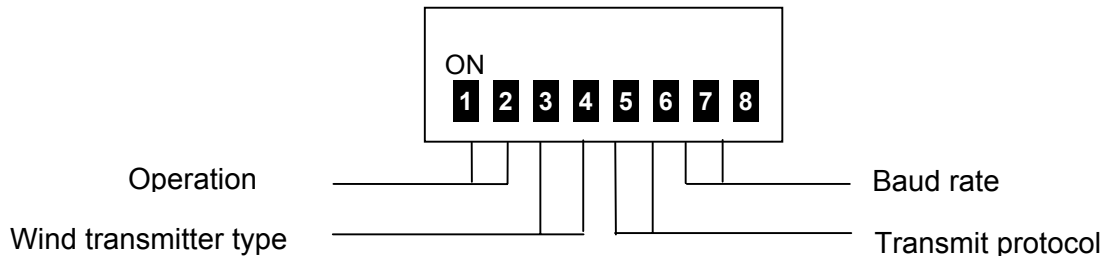

Figure 5: DIP-switch

7.1 Setting Mode of Operation

Remark:

The settings of the operation modes are possible only in the display 1 „mom“ (ref. chapter 3.1).



Mode of Operation	S1	S2
WD instantaneous	On	On
WD delayed	Off	On
WD instant. & variation	On	Off
WD delayed & variation*	Off	Off

*Delivery state: S1 = Off, S2 = Off

7.2 Setting Wind Transmitter Type

Remark:

Applies only for model no. 4.3250.0x.000

The wind transmitter and wind transmitter pairings are assigned using switches S3 and S4.



Wind transmitter / Wind transmitter pairing	S3	S4
Wind transmitter type „Classic” 4.3336.21.000 / 001 4.3336.31.000 / 001 4.3336.22.000 / 001 4.3336.32.000 / 001 4.3303.22.000 with 4.3125.32.100 4.3303.22.007 with 4.3125.32.100 4.3303.22.000 with 4.3125.33.100 / 101 4.3303.22.007 with 4.3125.33.100 / 101 Wind transmitter type „Compact” 4.3519.00.000 with 4.3129.00.000 4.3519.00.000 with 4.3129.60.000	On	On
Wind transmitter type „Classic” 4.3336.21.008 4.3336.31.008 4.3336.22.008 4.3336.32.008 4.3303.22.008 with 4.3125.32.100 4.3303.22.018 with 4.3125.32.100	Off	On
Wind transmitter type „First-Class” 4.3351.x0.000 with 4.3150.x0.000	On	Off
Wind transmitter type „WD-First-Class” with Wv-signal acquisition 4.3150.x0.400 Note: Is valid only with supply from the Wind display LED	Off	Off

7.3 Setting Data Protocol

For the serial communication four protocols are available for selection in Master / Slave – operation (ref. chapter 8.).



Telegram Type	S5	S6
Pn0*	On	On
Pn1	Off	On
Pn2	On	Off
Pn3	Off	Off

*Delivery state: S5 = On, S6 = On

7.4 Setting Baud rate



Baud rate	S7	S8
1200	On	On
2400	Off	On
4800	On	Off
9600*	Off	Off

*Delivery state: S7 = Off, S8 = Off

8 Data Protocol

Sending:

For the data output four protocols are available for selection (Pn0..3). They can be selected through the 8-fold DIP-switch (ref. chapter 7.3)

Type	Protocol	Format	Specification
Pn0	LED-Standard	<STX>XXX.X XXX*hh<CR><ETX>	7E1
Pn1	Ultrasonic	<STX>XX.X XXX xxx.x xx*hh<CR><ETX>	8N1
Pn2	NMEA0	\$WIMWV,xxx.x,a,xx.x,a,A*hh<CR><LF>	8N1
Pn3	NMEA1	\$WIMWV,xxx.x,a,xxx.x,a,A*hh<CR><LF>	8N1

Table 3: Data Protocol

Note: <STX> = 0x02, <ETX> = 0x03, <CR> = 0x0D, <LF> = 0x0A

Note: **X** → number 0...9 or F (error)

Note: **x** → number 0...9

Note: „*“ = check sum identification

Note: **hh** h_1 = High-Byte, h_2 = Low-Byte

Protocol specification

Pn0

<STX>xxx.x xxx*hh<CR><ETX>

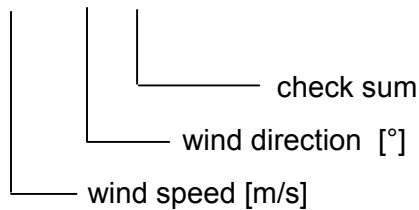

Pn1

<STX>xx.x xxx xxx.x xx*hh<CR><ETX>

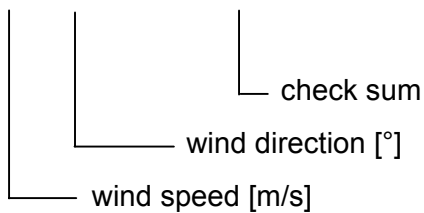

Pn3(Pn2)

\$WIMWV,xxx.x,a,xxx.x,a,A*hh<CR><LF>

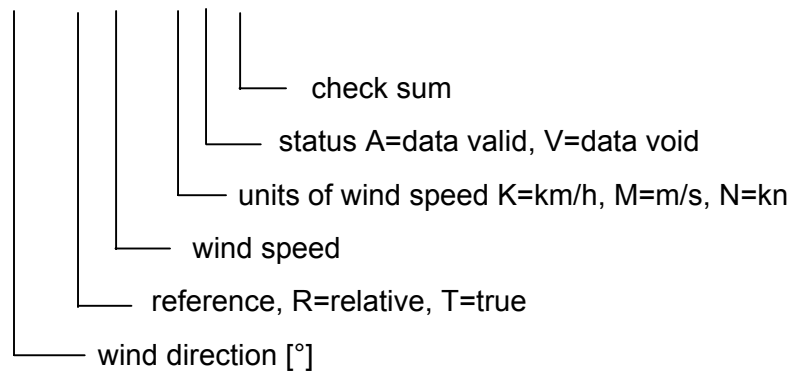

VDT (Ultrasonic)

00TR00002<CR>

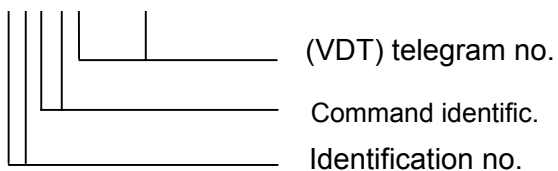

Receiving

The protocols given in table 3 can be received automatically *without selecting* the protocol. For this, it is only necessary to set the respective baud rate (ref. chapter 7.4).

An „a“ in the status of a received telegram requires the display of the respective wind values.

Checksum in the Protocol

The calculation of the check sum in the different protocols is carried out between the characters <STX> resp. ,< and ,>. The check sum consists of the XOR-relation of all characters between the separator STX> resp. ,< and ,>.

Two ASCII-characters (High and Low nibble) with a value range from 0...F (hexadecimal) are generated from the check sum. The character with the highest value is transmitted first.

Example standard telegram:	Wind speed:5.2 m/s
	Wind direction: 125°
	Telegram: "(STX) 5.2 125*1F(CR)(ETX)"

9 Operation

Operation of the Wind display LED is performed from the front. 5 buttons are available for operation as can be seen from the figure below. Whenever a button is pressed, this is acknowledged by a short beep.

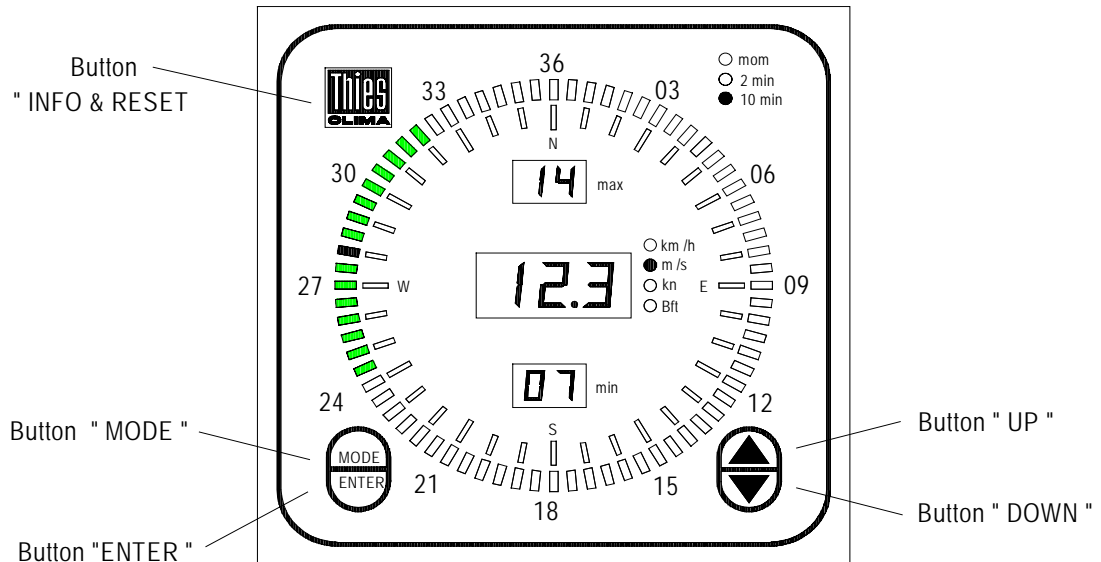

Figure 6: Operation

Button functions:

Button "▲"(UP) and Button "▼" (DOWN):

The buttons ▲ and ▼ are used to select the functions for entering **MODE 0,1 and 2**.

Button „ENTER“ :

The button **ENTER** is used to accept the respective setting into **MODE (n)**. Afterwards, the display enters automatically **MODE 0**.

Button „MODE“:

The **button MODE** is used to advance to the next MODE setting functions. The associated Status LED flashes.

Remark:

*After a restart the display automatically enters mode **MODE 0***

MODE	MENU
MODE 0	<p>Setting the brightness: The buttons ▲ & ▼ are used to dim the brightness level of the LED display in 18 steps.</p> <p>Setting the Max- and MIN- brightness: If the buttons ▲ or ▼ and the "Enter button" are pressed simultaneously, the brightness level previously selected can be stored as a MAX and MIN value.</p> <p>Calling up the Max- und MIN- brightness: The stored brightness values can be called up by pressing either the button ▲ or ▼ for 3 seconds.</p>
MODE 1	<p>Setting the Wind Speed- Dimension: The buttons ▲ & ▼ are used to select the WS-Dimension (km/h, m/s, kn and Beaufort).</p>
MODE 2	<p>Setting the Wind Display / Resetting of Extreme Values: The buttons ▲ & ▼ are used to select the display "instant.", or "2min, 10min"-mean value.</p> <p>Wind - display 1 „instantaneous“ Wind - display 2 „2min“ Wind - display 3 „10min“</p> <p>Resetting of Extreme Values (possible with Figure1 Display): Activate the button „ENTER“.</p>
MODE 3	<p>Setting of the COM1 (RS422 / RS485) Function is set by buttons ▲ & ▼</p> <p>3 – 0 :COM1 = RS422 (Full duplex) standard 3 – 1 :COM1 = RS422 (Full duplex) Only reception of \$WIMWV..Rel / True 3 – 2 :COM1 = RS485 (Half duplex) Request of VDT – Telegram from Ultrasonic</p>
*MODE 4	<p>WV- Measuring range selection (analogue wind transmitter or analogue output) With buttons ▲ & ▼ measuring range is selected</p> <p>4 – 0 : 40m/s 4 – 1 : 50m/s 4 – 2 : 60m/s 4 – 3 : 75m/s</p>
*MODE 5	<p>Setting of the analogue in/output In/output function is set via buttons ▲ & ▼.</p> <p>5 – 0 : analogue input ON, analogue output OFF 5 – 1 : analogue input OFF, analogue output ON</p>

*MODE4 and MODE5 are available only in conjunction with analogue inputs or analogue output

Button „INFO & RESET“:

When the button **INFO & RESET** is pressed, a LED test starts.

- All LED's light up
- Display of device parameters (ref. **Table 4**)
- Restart of wind display LED.

Example	
Device parameter	Display
Software	
Version No. (e.g.)	r 1.1
Input type	
Wind transmitter input	AL0
COM interface	AL1
Wind transmitter type	
Classic	CL1
Classic	CL2
Compact	CoP
First-Class	F-C
Input telegram	
NMEA REL/TRUE	Pr1
Output telegram	
LED Standard	Pn0
Ultrasonic	Pn1
NMEA0	Pn2
NMEA1	Pn3
Baud rate	
1200	b12
2400	b24
4800	b48
9600	b96
*analogue inputs	
0..5V/0..10V	u5
0..20mA	i20
4..20mA	i42
*analogue output	
0..20mA	Au1
4..20mA	Au2
0..5V	Au3
0..10V	Au4

Table 4: Instrument parameter

***Display only when analogue inputs and analogue outputs are available**

External Operation

In addition to operation from the front remote control of the wind display LED is also possible using the rear clamping plug “Remote” (K2), and external buttons for remote control. The buttons for remote control are not included in the scope of supply.

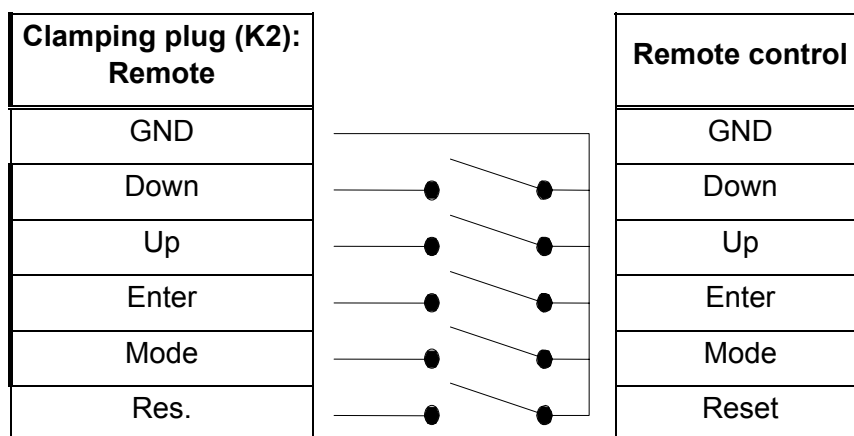

10 Functional Test

On restarting or activating the button **INFO & RESET** (ref. chapter 9) the wind display LED carries out a number of test procedures. In case of an error the display shows an error-code (ref. chapter 11). To run a full test on the wind interface no wind transmitter should be connected.

11 Error Message

If an error is detected while a program is running, the display will show the relevant error code for min. 3 seconds or as long as the error is present.

Error-Code	Error	Comment/Action
E01	Internal Vcc 5V	Instrument defect: send in for checking
E02	Vcc Wind transmitter	Disconnect wind transmitter, restart instrument. If error is still indicated, send instrument in for checking. Otherwise connect wind transmitters one after the other, and detect the defect wind transmitter
E03	Icc WS	Check cables and connections of wind speed transmitter. If error message is still existing, wind transmitter is probably defect
E04	Icc WD	Check cables and connections of wind transmitter. If error message is still existing, wind transmitter is probably defect
E05	WS-Interface	Instrument defect: send in for checking
E06	WD-Interface	Instrument defect: send in for checking
E07	WD-Serial	Check data-connection/-cable of the wind direction transmitter

		If error message is still existing, wind transmitter is probably defect
E08	WS-Overflow	1.Check setting of wind transmitter type 2. Check connection and cable If error message is still existing, wind transmitter is probably defect
E09	Timeout (COM)	1.Check setting of Baud rate 2.Check R422 connections/cables Rx+ & Rx- 3.If error message is still existing, connect Rx+ & Rx- to Tx+ & Tx- at the terminal strip. 4.If no error message is existing, the transmitter is defect 5. If error message is still existing, send instrument in for checking
E10	SIN-Buffer overflow	Check transmitted protocol
E11	Protocol format	Check transmitted protocol
E12	Check sum	Check transmitted protocol
E13	WS & WD error	Failure of wind transmitter at "Master" wind transmitter LED
E14	WS "FF.F"	Failure of wind speed transmitter at "Master" wind transmitter LED
E15	WD "FFF"	Failure of wind direction transmitter at "Master" wind transmitter LED
E16	REL/TRUE error	Check transmitted protocol (error twice „a“ in the telegram)
E17	VDT protocol	No reception from Ultrasonic - check connection (RS485 half duplex)
E20	WV U/I Range	WV Analogue input: U/I measuring range exceeded
E21	WD U/I Range	WD Analogue input: U/I measuring range exceeded
E50	Syntax-Error	Instrument defect, restart possibly
E99	Watchdog	Temporary failure if error message is displayed once for 3 sec. If error message occur oftentimes, instrument is defect

Table 5: Error messages

12 Maintenance

The wind display LED is maintenance-free

Cleaning

To clean the face plate and housing a damp cloth should be used without chemical cleaning agents.

Storage

The wind display LED should be stored in a dry dust-free room at temperatures between -20.. + 50°C. We recommend storing the device in a box.

Fuse

There is a mains fuse on the rear of the wind display LED. The fuse holder can be opened using a screwdriver.

Attention:

In case of a defect only the following fuses should be used:

230V ; 0,25 A slow for wind display 4.3250.00.xxx

115V.; 0,5 A slow for wind display 4.3250.01.xxx

13 Technical Data

Wind transmitter inputs (digital)

Wind direction	Input	Thies Serial Synchronous
	Type	Compact 4.3129.00.000 / 4.3129.60.000 Classic 4.3125.x2.100 / 101 Classic 4.3336.x1.00x / 4.3336.x2.00x First Class 4.3150.x0.000
	Sampling rate	10Hz
Wind velocity	input	Frequency
	level (Ua)	Ua ≤ 1V , Ua ≥ 3.3V
	Frequency (max)	Compact 1000 Hz Classic 1550 Hz Classic 850 Hz First Class 1600 Hz
	Type	Compact 4.3519.00.000 Classic 4.3303.22.000/007/008/018/4.3336.x1.00x 4.3336.x2.00x First-Class 4.3351.x0.000
	Sampling rate	1Hz
Wind transmitter supply	Vcc WR / WG	5.1... 5.7 V
	Icc max	60mA

Wind transmitter input (analogue)

Wind velocity	Input	0..5V / 0..10V / 0..20mA / 4..20mA
	Measuring range	40m/s, 50m/s, 60m/s, 75m/s selectable
Wind direction	Input	0.. 2V, 0..5, 0.. 10V, 0.. 20mA, 4.. 20mA
	Measuring range	0..360°
WV / WD	Resolution	0.06% @ 2V, 0.025% @ 5V, 0.049% @ 10V 0.049% @ 0..20mA, 0.06% @ 4..20mA
	Load	125Ω (input 0/4..20mA)
	Input resistance	>1MΩ (input 2V,5V); 20kΩ (input 10V)
Wind transmitter supply (only with 4.3250.0x.1xx)	Vcc WV/WD	12 V
	Icc max	80 mA

Output (analogue)

Wind velocity	Output	0..5V / 0..10V / 0..20mA / 4..20mA
	Meas. range	40m/s, 50m/s, 60m/s, 75m/s adjustable
Wind direction	Output	0..5, 0.. 10V, 0.. 20mA, 4.. 20mA
	Meas. range	360 Grad
WV / WD	Resolution	0.05% @ 5V, 0.03% @ 10V 0.1% @ 0..20mA, 0.1% @ 4..20mA
	Accuracy	U(V) = ±0,3% I(mA) = ±0,3%
	Load (I)	≤ 400Ω
	Load (U)	>50kΩ (output 0..10V), >1kΩ (output 0...5V)

Interface

Digital Interface		EN 61162-1
	Type	RS422 / RS485
Data format	Output	7E1, 8N1
	Input	7E1, 8N1, 7O1
	Baud rate	1200, 2400, 4800, 9600 Bd
Operating Voltage	Mains	230V AC (with 4.3250.00.000) 115V AC (with 4.3250.01.000)
	Mains fuse	0,25 A (slow) resp. 0,5 A (slow)
	Low voltage	18... 28 V AC 12... 35 V DC
	Current consumption	Max. 1000mA at 12V DC

Display

Wind speed	Dimension	m/s, kn, km/h, Bft
	WS - Display	3 digit LED, height 15mm
	Resolution	0,1 m/s 0,1 kn from 100kn 1kn 1 km/h 1 Bft
	WS-max/min Display	2 digit LED, height 8 mm
	Resolution	1 m/s / 1 kn / 1 km/h / 1 Bft
Wind direction	Resolution	5 °
	LED's	72; 2 x 4mm, colour: red, green
	Tracking time of variation	1 increment /sec
	WD-delay	T = 6 sec.

General

	Temperature range	-10....+50 °C
	Humidity range	Non-condensing
	EMC	EN 60945, EN 61000-6-2, EN 61000-6-3
	Vibration	EN 60945, IEC 60068-2-6
	Environmental test	EN 60945
	Guard band of compass	EN 60945 Safe distance to the Standard- Magnetic- compass 0.50 m Steering- Magnetic- compass 0.35 m

Housing

	Material	Aluminium
	Dimensions	144 x 144 mm Depth: 119 mm
	Weight	1,5 kg
	Protection	IP23; EN 60529

14 Dimensional Drawing

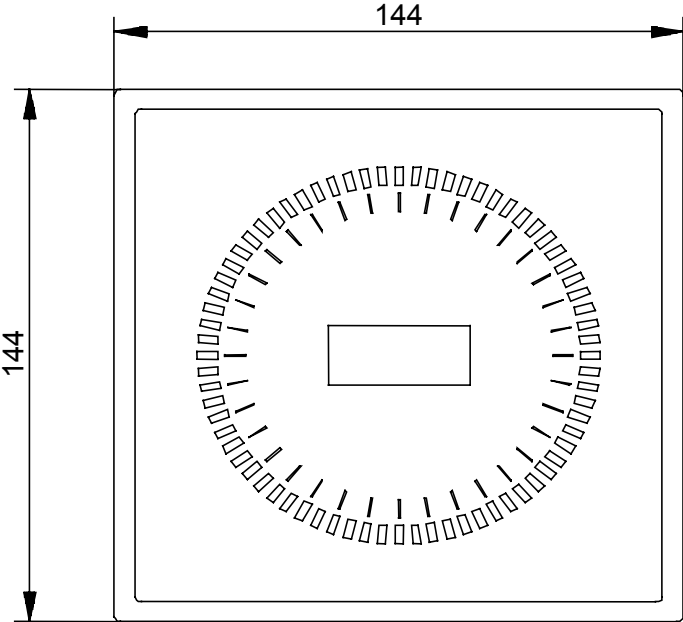

Control panel opening
as per DIN 43700
138⁺¹ x 138⁺¹

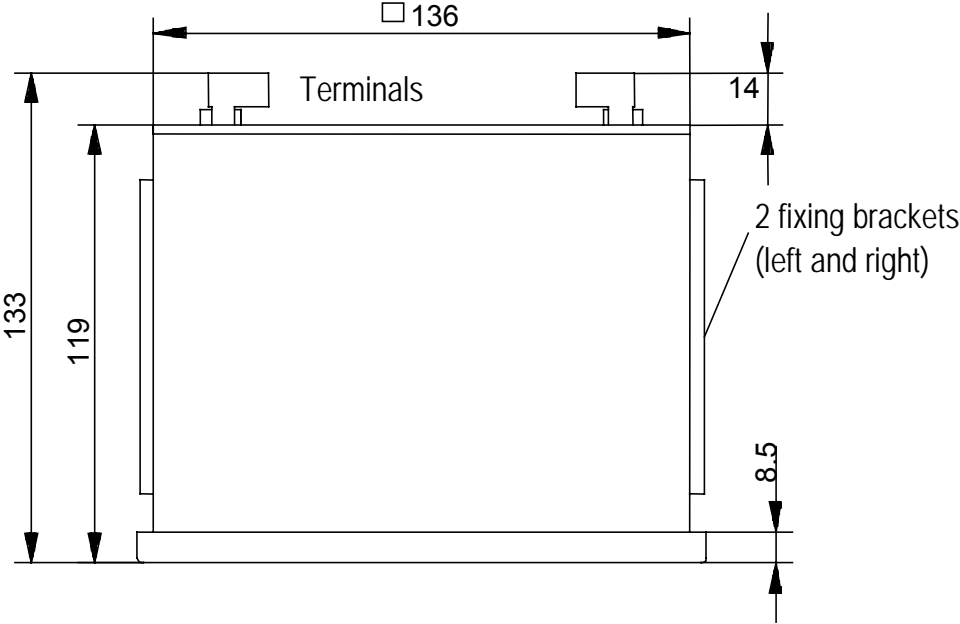

15 EC-Declaration of Conformity

Document-No.: 002003

Month: 02 Year: 12

Manufacturer: **ADOLF THIES GmbH & Co. KG**

Hauptstr. 76

D-37083 Göttingen

Tel.: (0551) 79001-0

Fax: (0551) 79001-65

email: Info@ThiesClima.com

Description of Product: **Wind Display LED**

Article No.	4.3250.00.000	4.3250.00.040	4.3250.00.041	4.3250.00.061
4.3250.00.073	4.3250.00.140	4.3250.00.141	4.3250.00.161	4.3250.00.173
4.3250.00.900	4.3250.01.040	4.3250.01.041	4.3250.01.061	4.3250.01.073
4.3250.01.000	4.3250.01.140	4.3250.01.141	4.3250.01.161	4.3250.01.173
4.3250.01.900	4.3251.00.000	4.3251.00.001	4.3251.00.002	4.3251.00.040
4.3251.00.041	4.3251.00.061	4.3251.00.073	4.3251.00.140	4.3251.00.141
4.3251.00.161	4.3251.00.173	4.3251.00.902	4.3251.01.000	4.3251.01.001
4.3251.01.002	4.3251.01.040	4.3251.01.041	4.3251.01.061	4.3251.01.073
4.3251.01.140	4.3251.01.141	4.3251.01.161	4.3251.01.173	4.3251.01.902

specified technical data in the document: 021386/01/09; 021342/01/00; 021407/12/10; 021459/07/05; 021626/09/09

The indicated products correspond to the essential requirement of the following European Directives and Regulations:

2004/108/EC	DIRECTIVE 2004/108/EC OF THE EUROPEAN PARLIAMENT AND OF THE COUNCIL of 15 December 2004 on the approximation of the laws of the Member States relating to electromagnetic compatibility and repealing Directive 89/336/EEC
2006/95/EC	DIRECTIVE 2006/95/EC OF THE EUROPEAN PARLIAMENT AND OF THE COUNCIL of 12 December 2006 on the harmonisation of the laws of Member States relating to electrical equipment designed for use within certain voltage limits
2002/75/EC	COMMISSION DIRECTIVE 2002/75/EC of 2 September 2002 amending Council Directive 96/98/EC on marine equipment
552/2004/EC	Regulation (EC) No 552/2004 of the European Parliament and the Council of 10 March 2004 on the interoperability of the European Air Traffic Management network (the interoperability Regulation)

The indicated products comply with the regulations of the directives. This is proved by the compliance with the following standards:

Reference number	Specification
IEC 61000-6-2: 2005	Electromagnetic compatibility Immunity for industrial environment
IEC 61000-6-3: 2006	Electromagnetic compatibility Emission standard for residential, commercial and light industrial environments
IEC 61010-1: 2010	Safety requirements for electrical equipment for measurement, control, and laboratory use. Part 1: General requirements
IEC 60945: 2002	Maritime navigation and radiocommunication equipment and systems Part 8.7 Vibration Part 8.12 Test Kb: Salt mist, cyclic (sodium, chloride solution) Part 9 Test of emission Part 10 Test of immunity Part 11.2 Safe distance to magnetic-compass Part 12.1 Degrees of protection provided by enclosures

Place: Göttingen

Date: 09.02.2012

Legally binding signature:

issuer:

.....
Wolfgang Behrens, General Manager

.....
Joachim Beinhorn, Development Manager

This declaration certifies the compliance with the mentioned directives, however does not include any warranty of characteristics. Please pay attention to the security advises of the provided instructions for use.



ADOLF THIES GmbH & Co. KG

Hauptstraße 76 37083 Göttingen Germany
P.O. Box 3536 + 3541 37025 Göttingen
Phone +49 551 79001-0 Fax +49 551 79001-65
www.thiesclima.com info@thiesclima.com



- Alterations reserved-