

# LUMISYS

BUILT FOR INTEGRATION

## Lumisys MX Series

# Installation Guide

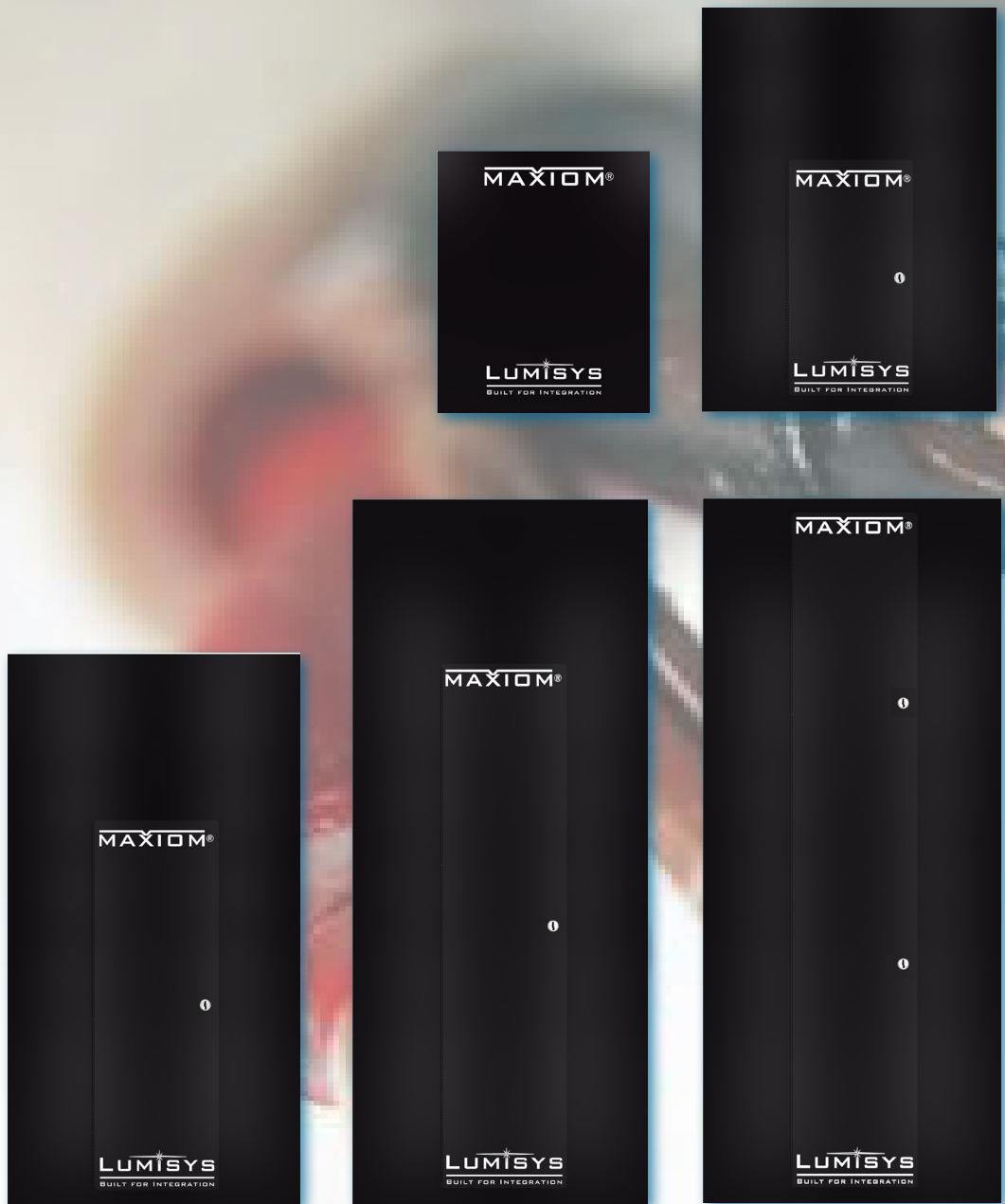

### ATTENTION

This section serves as a notice of the immediate or potential dangers involved when working with the equipment described throughout this manual. Any person involved in installation, maintenance, or service of the equipment should first carefully examine the equipment and read the instructions contained in this manual to ensure that personal and/or equipment injury is avoided.

The following safety messages are used throughout this manual to alert of immediate or potential danger to life or property:



**Hint** Indicates a tip or trick to help you.



**Note** Indicates an important note.



**DANGER!** Indicates an immediately hazardous situation which, if not avoided, will result in death or serious injury.



**WARNING!** Indicates a potentially hazardous situation which, if not avoided, can result in death or serious injury.



**CAUTION:** Indicates a potentially hazardous situation which, if not avoided, can result in minor or moderate injury.

**CAUTION:** Used without the safety alert symbol, indicates a potentially hazardous situation which, if not avoided, can result in personal or property damage. Failure to comply with proper handling of the Lumisys products may void your warranty



In addition, this symbol may appear in the margin of specific portions of text as a safety reminder. Applicable instruction steps will be listed beneath the symbol.

### Disclaimer

This equipment has been tested and found to comply with the limits for a Class A digital device, pursuant to part 15 of the FCC Rules. These limits are designated to provide reasonable protection against harmful interference when the equipment is operated in a commercial environment. This equipment generates, uses, and can radiate radio frequency energy and, if not installed and used in accordance with the instruction manual, may cause harmful interference to radio communications. Operation of this equipment in a residential area is likely to cause harmful interference, in which case the user will be required to correct the interference at his own expense.

Instructions contained in this user's guide should be performed only by qualified persons in accordance with local and national codes. Lumisys® Lighting and its affiliates assume no responsibility for any consequences related to the improper use of this manual.





### Table of Contents

Overview .....	3
Inspection .....	4
Installation .....	5
Connecting the Power Supply .....	6
Connecting the Power Supply con't .....	7
Connecting Branch Circuit Wires .....	8
Connecting Branch Circuit Wires con't .....	9
Connecting Switch Inputs .....	10
Connecting Switch Inputs con't .....	11
Connecting the RS-485 Network .....	12
Connecting Lumisys LS5 Photocell Inputs .....	13
Adding and Removing LTR Relays .....	14
Connecting to Digi-Touch Addressable Switch Network .....	15
Terms and Conditions of Sale .....	16

### Overview

This document provides instructions on how to physically install the Lumisys MX Series Lighting Relay Panel. For panel configuration and programming refer to *Maxiom User's Guide- Hardware and Maxiom User's Guide - Software*. For network point descriptions and integrations to a building automation system refer to the appropriate *Maxiom Integration Guide*.

### Product Family Comparison

	MX08	MX16	MX32	MX48	MX60
<b>Panel</b>					
Dimensions (Width x Height x Depth)	13" x 16" x 4"	18" x 25" x 5 3/4"	18" x 33 3/4" x 5 3/4"	18" x 45 1/2" x 5 3/4"	18" x 45 1/2" x 5 3/4"
Contactor Mounting Space	N/A	8.0" x 8.0" x 5.0"	8.0" x 8.0" x 5.0"	8.0" x 8.0" x 5.0"	N/A
Trim Style	Screw on	Tru-lock	Tru-lock	Tru-lock	Tru-lock
Controller	Lx5	Lx5	Lx5	Lx5	Lx5
Flash Upgrade	Yes	Yes	Yes	Yes	Yes
<b>Inputs</b>					
Digital Subnet for Switches and Occupancy Sensors	Digi-Touch Native	Digi-Touch Native	Digi-Touch Native	Digi-Touch Native	Digi-Touch Native
Binary inputs available without option card	24	24	56	88	120
Analog Inputs available without option card	6	6	6	6	6
Optional Telephone Override Card	No	Yes	Yes	Yes	Yes
<b>Outputs</b>					
Relay Panel Capacity	8	16	32	48	60
Latching Relay with manual override on relay	Yes, Lumisys True Relay (LTR)	Yes, Lumisys True Relay (LTR)	Yes, Lumisys True Relay (LTR)	Yes, Lumisys True Relay (LTR)	Yes, Lumisys True Relay (LTR)

Warranty

24 months from date of shipment.  
Refer to Lumisys Terms and Conditions of Sale for additional details.

### Inspection

The MX Series comes in five basic units based upon relay capacities: MX08, MX16, MX32, MX48, and the MX60. Each unit may contain up to the number of relays indicated. Enclosure sizes for each of the five units will vary

Pictures of the MX08 and MX32 appear below showing the main components. Check each unit for shipping damage or missing parts

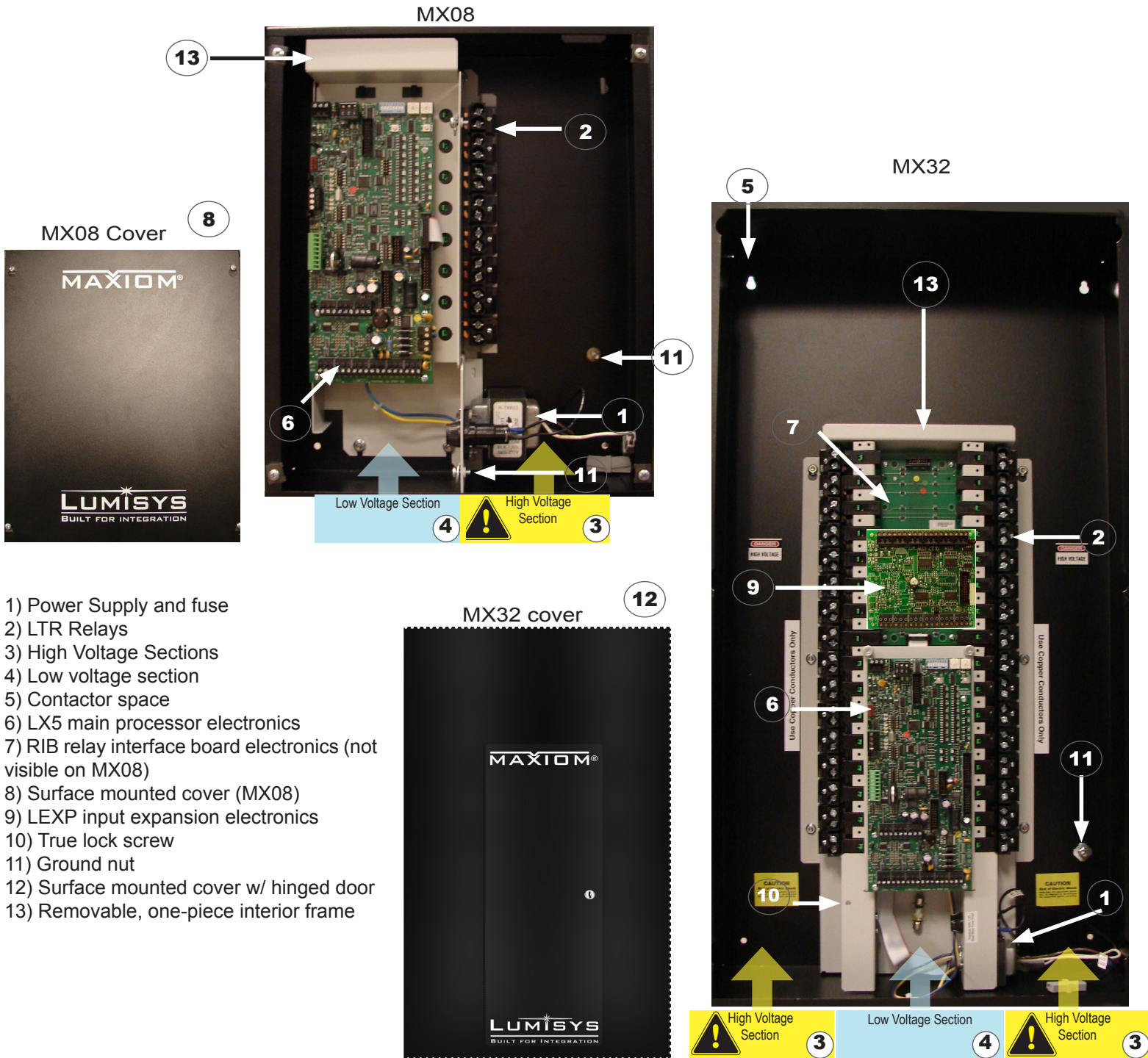

### Installation

#### Mounting the MX Series Enclosure

**1. Knockout Holes for high and low voltage conduit connections.** Below illustrates areas in the MX Series enclosure where conduit holes for high and low voltage wiring can be made.

a. Remove the interior. If the panel was shipped with electronics installed, remove the interior with electronics until all holes for conduit are punched and all metal shavings are removed. Metal shavings from drilling could lodge in the electronic components and cause damage.

The interior is held to the enclosure by flange nuts. See picture below.  
Remove the interior and place it away from any work area before drilling holes for conduit.

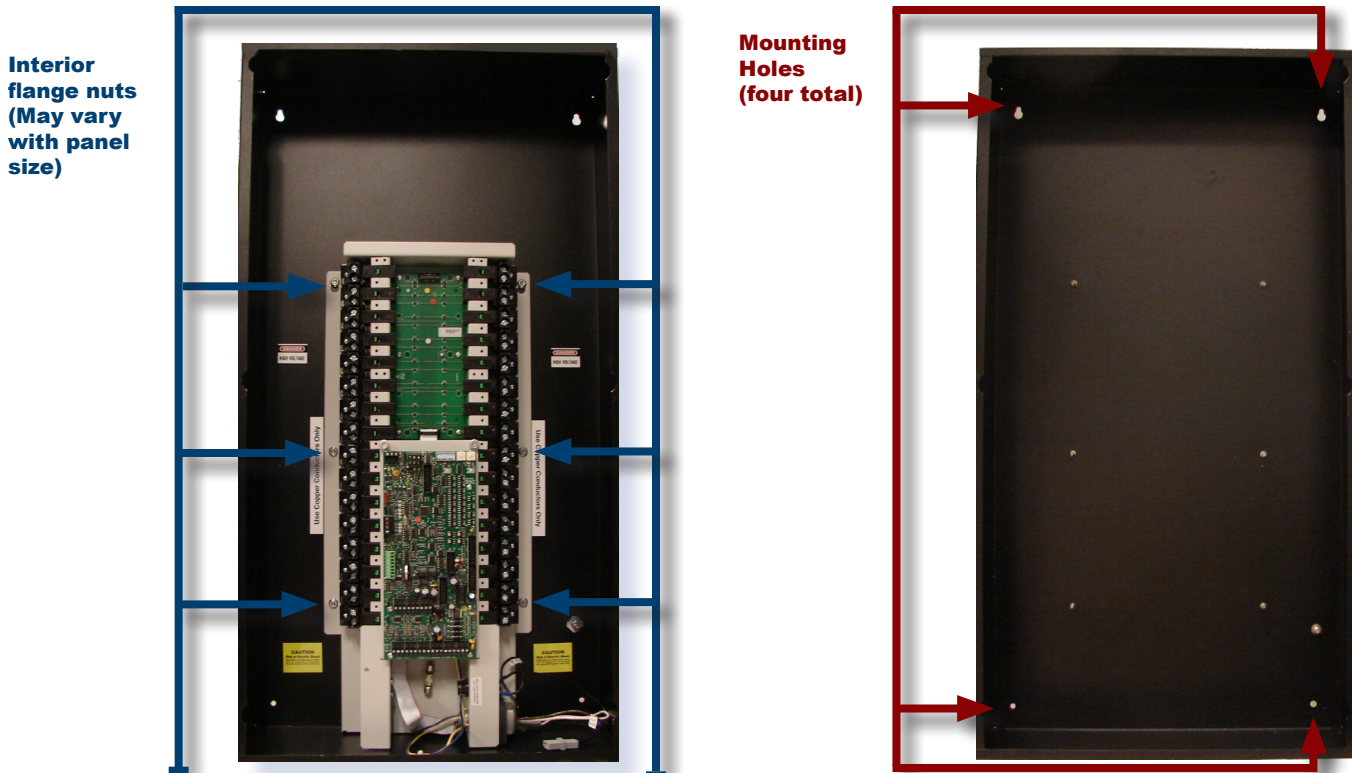

**2. Mount the enclosure with anchors and screws** according to picture above .

The picture on the right illustrates the location of the panel mounting holes. The top two mounting holes of the panel enclosure are keyhole shaped so you can slide the unit over mounting screws, avoiding the need to hold the unit while trying to secure the mounting screws. Use wall anchors capable of supporting 6lbs for MX08, 16lbs for MX32 and 25lbs for MX60.

If flush mounting, secure the enclosure between the wall studs. Be sure to allow for the thickness of the drywall and 7/8" for the overhang of the cover so that the panel's cover will mount flush on the finished wall and away from adjacent panels.

### Connecting the Power Supply

The MX Series can be powered by either 120 or 277VAC. A fuse and dual primary transformer are utilized to offer maximum flexibility during installation. This factory mounted transformer powers the MX Series controller and associated low voltage coils on the contactors (relays).

- 1. If connected, remove the power harness from the MX Series controller.** See Figure 4 for location of the harness on the controller. Remove the harness by lifting on the terminal block of the harness.
- 2. Connect main power to the transformer and fuse assembly.** Locate the Common (white) wire and the hot (black) wire for connection to main power. Figure 4 shows the connectors on the white and black wires.

Power harness  
from transformer  
(24VAC)

Figure 4

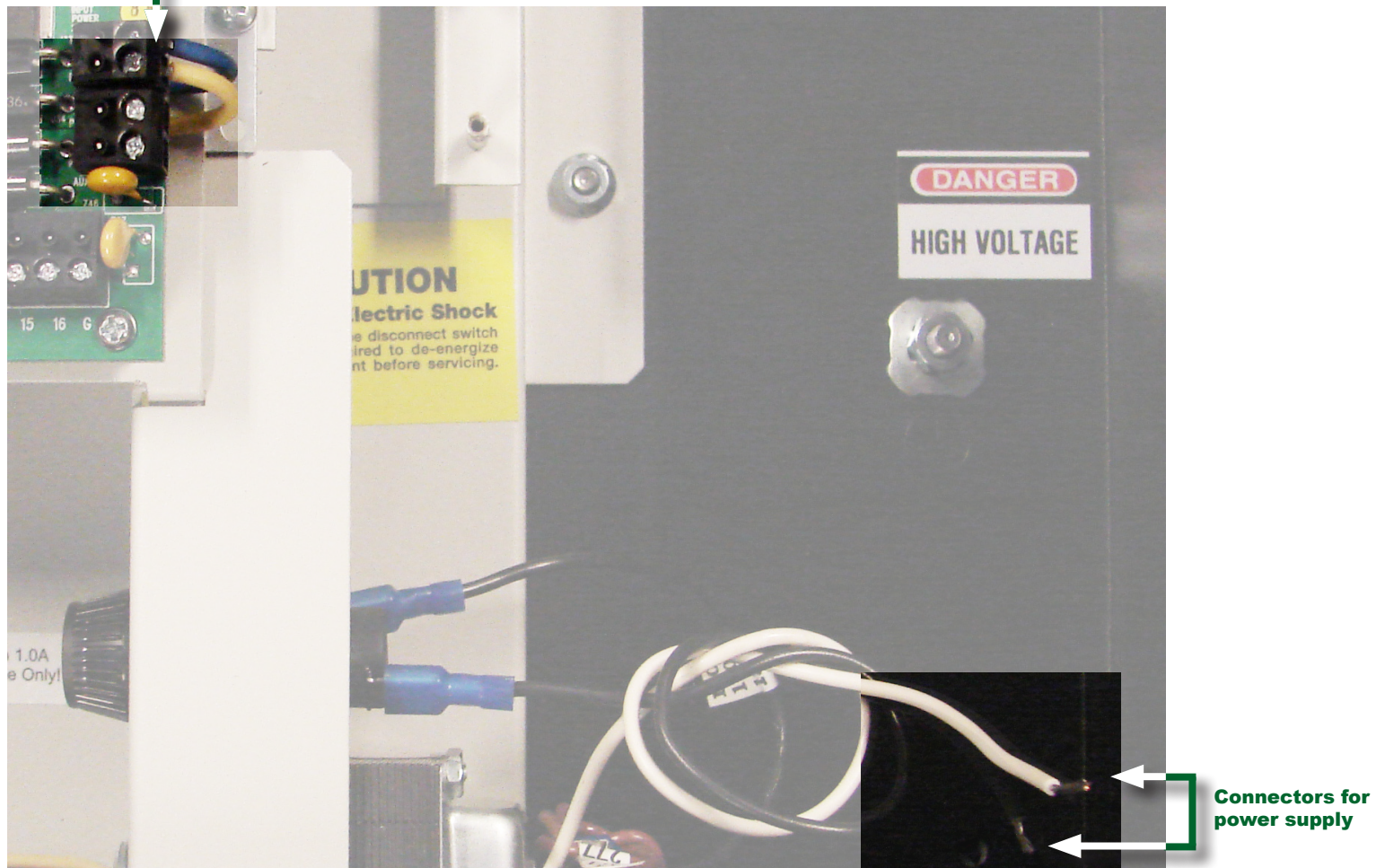

### Connecting the Power Supply

**3. Locate wire with correct voltage and connect to fuse.** Refer to Figure 5. Power is connected by choosing the proper voltage wire stemming from the transformer and connecting that wire to the fuse holder. Each wire is labeled either 120V or 277V. The 120V wire should be black and the 277V wire should be brown. If this is not the case contact the factory immediately. Each wire is terminated with a spade connector that inserts over a contact on the fuse holder.

Figure 5

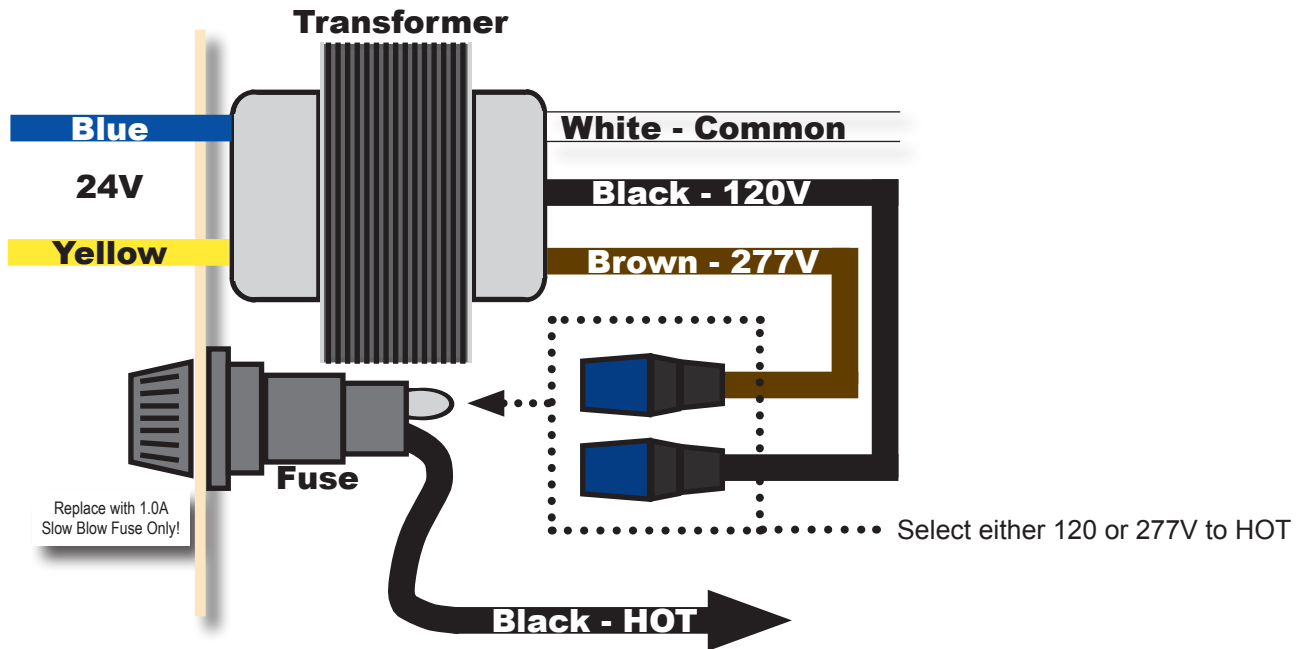



### Connecting Branch Circuit Wires

The MX Series panel is equipped with relay capable of switching up to 20 amperes at 277 VAC (Canadian versions, 347VAC). Each relay can be easily assigned to any of the unit's zones.

The following figure is a typical wiring diagram. Be sure not to exceed 20 amperes per relay. If the high voltage wiring requires both 120V and 277V on the same high voltage of the panel, a Lumisys *MXDIV* will be required.

Figure 7

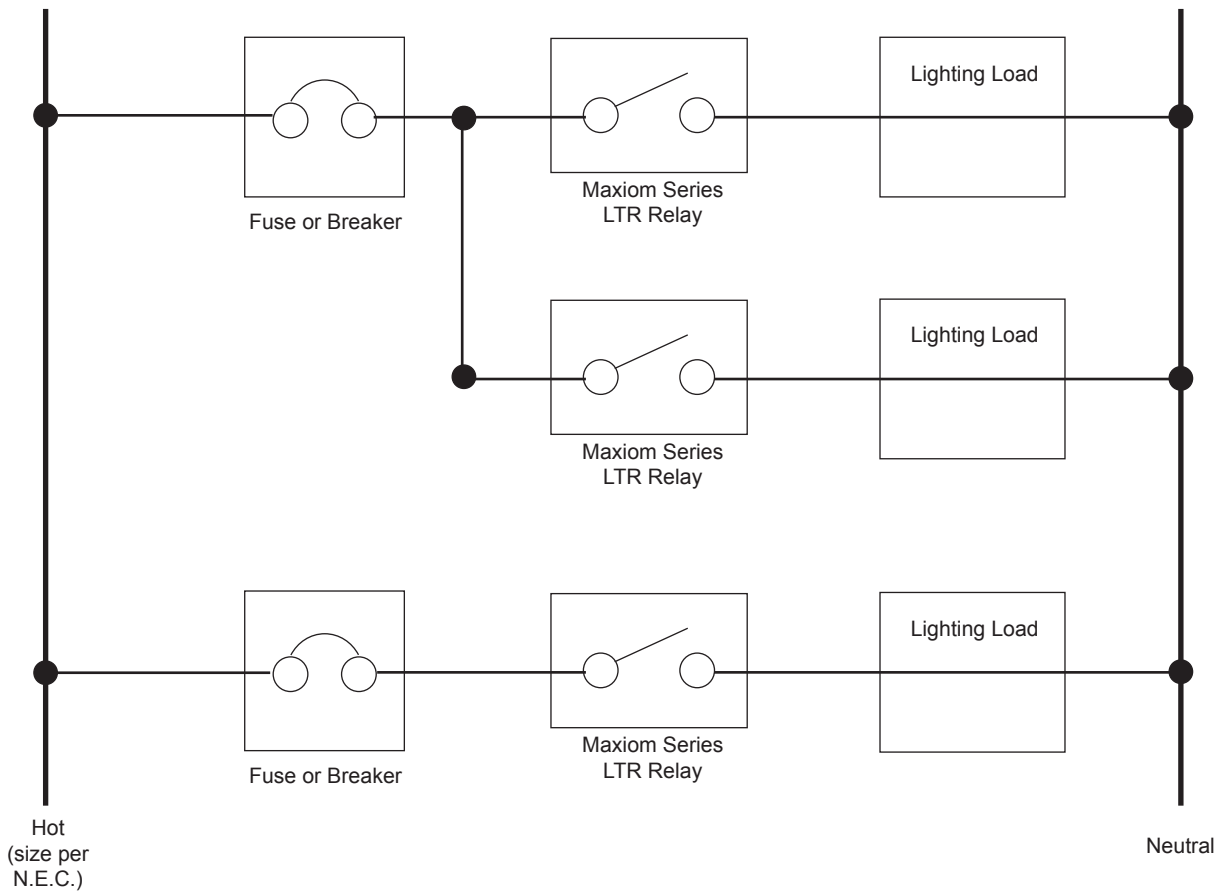

Steps 1-2



**WARNING!** Disconnect high voltage power to all circuits before connecting them to the MX Series. Failure to do so could result in serious injury.

**1. Pull branch circuit wires through high voltage conduit.** Note: All wiring should be in accordance with local regulations and the National Electric Code. Control signal wiring to the low voltage side of the unit should not be run in the same conduit as line voltage wiring or other conductors that supply highly inductive loads such as generators, motors, or high voltage circuits located on the high voltage side of the unit.

If 120V and 277V branch wires must be connected to relays on the same side of the panel do not run these wire through the same conduit. See Overview for high (load) and low (24V) voltage areas of the panel.

**2. Install each branch circuit in one relay as shown in Figure 6.** Each branch circuit can be installed in a relay as shown in Figure 6 below.

Figure 6

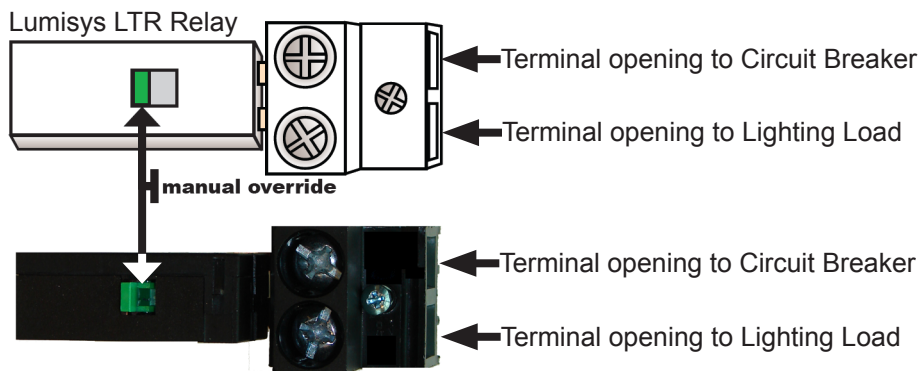

The Lumisys LTR Relay features manual override and large gauge terminal block capable of accommodating #14-8 AWG or two 10 AWG wires in each terminal opening.

### Connecting Switch Inputs

Switch input connections are made on the main processor card, The LX5. The LX5 controller comes standard with 24 programmable inputs. Input expansion cards (LEXP) increase input capacity and are standard on MX32 panels and higher in increments of 32. See table in Overview for details. Note LEXP cards are jumper addressed A, B, and C at the factory. Always power down the LX5 before connecting or removing card.

Figure 8

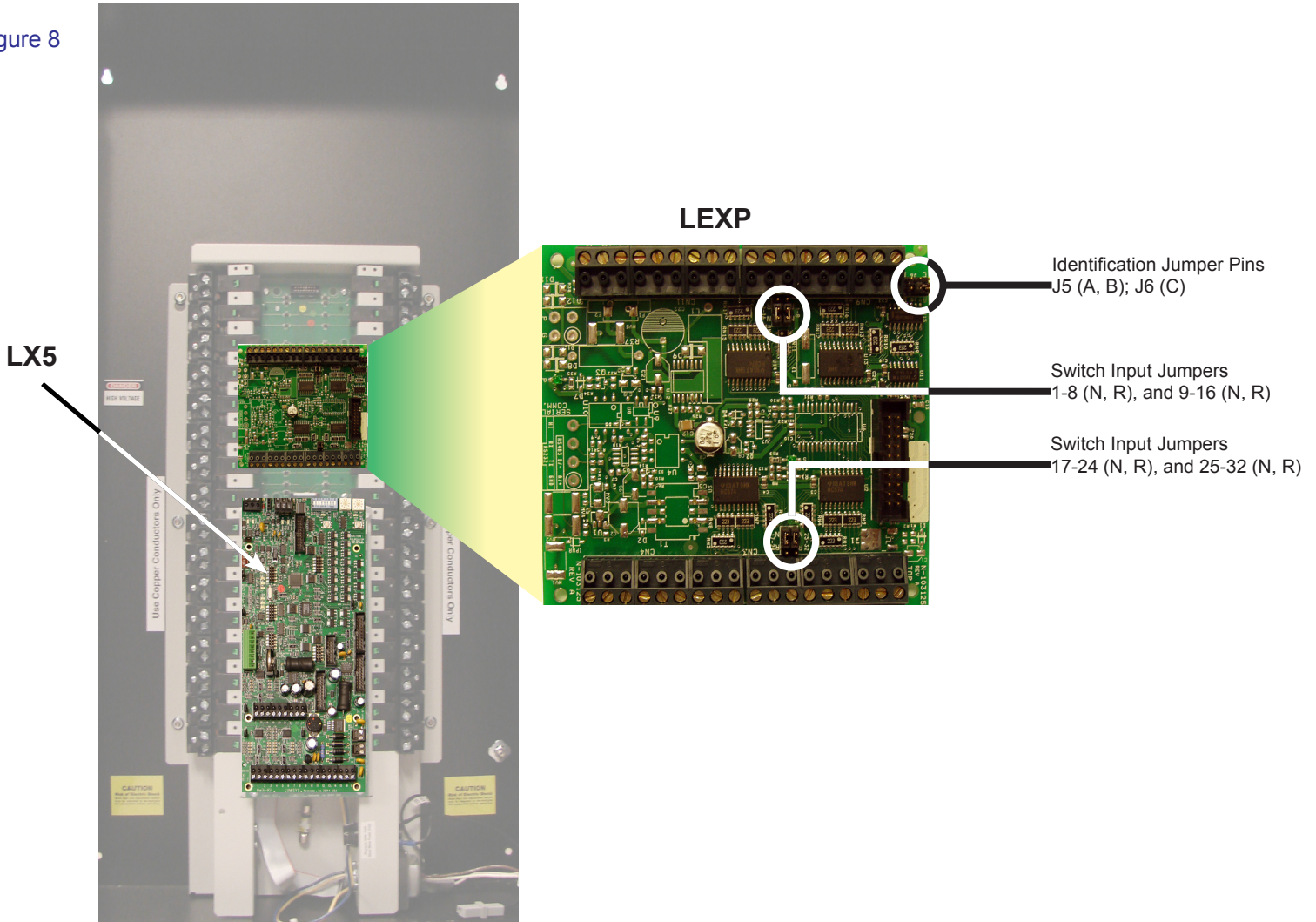

The inputs can be set in software as Momentary on, Momentary off, Momentary on/off, Maintained, Linked, or State change. Each section has an accompanying jumper that sets whether its associated eight inputs will be up to 24 VDC or dry (0 VDC).

Each jumper set has 3 pins, one of which is labeled “N”. The “N” jumper is for setting the switch inputs for dry contact. The “up to 24” pin of the jumper pin is not labeled. **Figure 9** shows how to place jumpers properly.

The jumper must be set before wiring.



**Note** *If one switch input is dry, the entire section of eight switch inputs must also be dry contacts, and the associated jumper must be in the “dry” position. If one switch input is externally powered up to 24 VDC, the entire section of eight switch inputs must also be up to 24 VDC, and the associated jumper must be in the “up to 24” position.*

**Figure 9**

Dry Position      Up to 24V Position



LX5 Switch Input Jumper Settings



**CAUTION!** Before handling any components on the circuit board, the installer should be grounded to prevent damaging the board.

**1. Remove power to the controller.** Refer to **Figure 4**. Remove the yellow/blue power harness by lifting on its terminator block.

**2. Set jumpers.** See explanations and **Figure 8** and **Figure 9**

**3. Connect the switches to the controller.** Connect one end of the switch or contact to terminal “G” and the other to terminal “1-24”. Momentary switches which have both an ON and Off contact will require two switch inputs on the controller. See **Figure 11** for sample wiring diagrams for each input type. Switch input terminal blocks are screw type. Land wires by unscrewing, inserting the stripped wire, and tightening the screw.

**4. Reconnect power to the controller.**

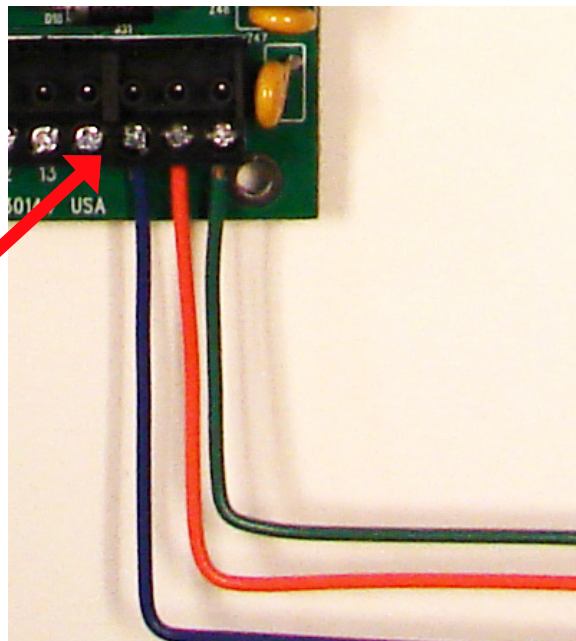
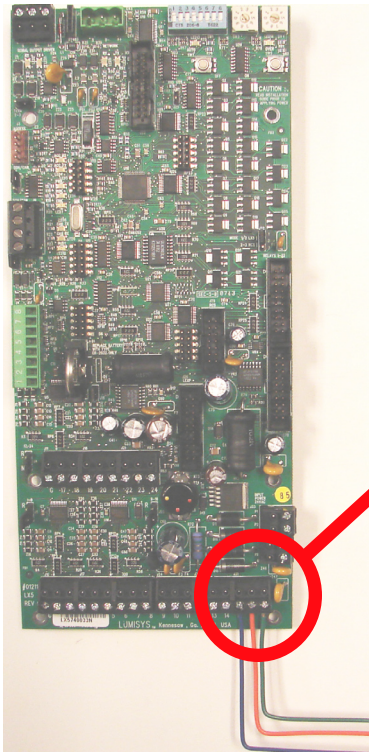

\*A maximum of 500 feet wire total is allowed, measured from the switch to the LX5 socket. Use 18-22AWG wire.

### Connecting the RS-485 Network

The MX Series is capable of being networked to a Building Automation System over a two or three wire RS-485 communication network. A terminal block is provided to connect the two communication wires plus the shield wire. (RS-485 wires are not provided by Lumisys.) Use 18 AWG stranded 600V insulated wire, twisted pair with shield. The RS-485 connection location and labeling is illustrated in [Figure 16](#).

- 1. Disconnect power to the MX Series LX5.** Refer to [Figure 4](#).
- 2. Connect incoming and outgoing transmit “+” to “+”** on the RS-485 connector. As with switch inputs, a screw type terminal block is provided.
- 3. Connect incoming and outgoing transmit “-” to “-”** on the RS-485 connector.
- 4.** When a shield wire is used, either **splice incoming and outgoing shield wires** together or connect to “S” on the RS-485 connector.
- 5. Reconnect power** to the MX Series LX5.

[Figure 16](#). RS-485 Connector Input Detail

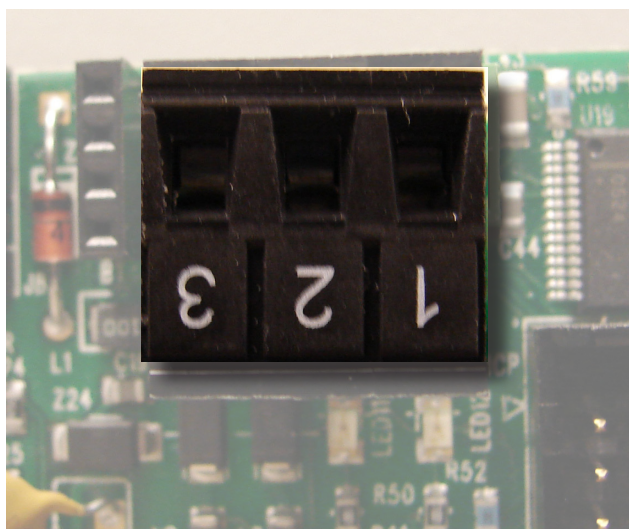

EIA-485 port w/ terminal block

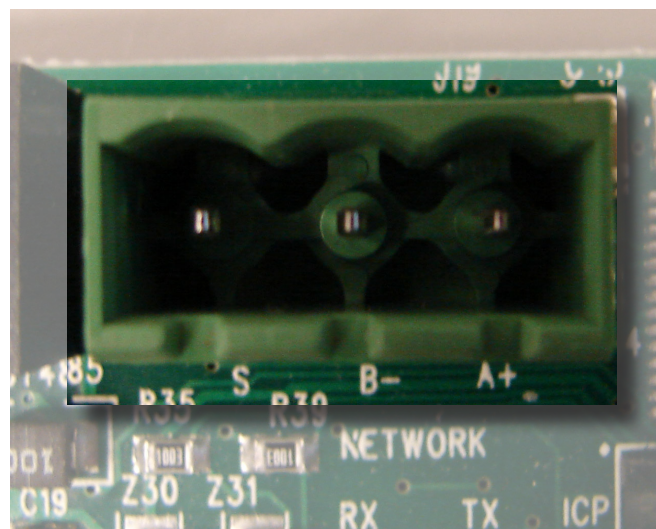

EIA-485 port showing S, (-), and (+) pins

### Connecting Lumisys LS5 Photocell Inputs

The MX Series Controller comes with six inputs for the LS5 Series Photocells. Each LS5 photocell ships with one pigtail wiring harness. The contents as shipped are shown in **Figure 12**. The LS5 photocells have three (3) wires each. **Figure 13** gives a wiring schematic for an example LS5 photocell.

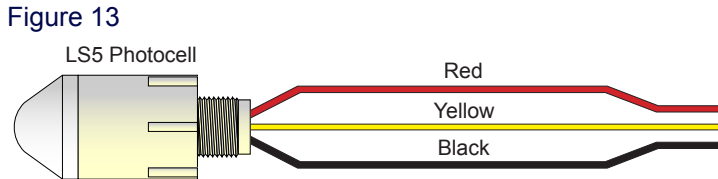
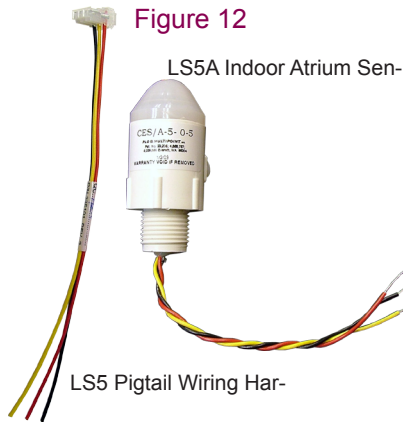

The photocell is powered by 5V from the MX Series Controller. The power circuit includes the Red (5V hot) and the Black (ground) wires. The yellow wire carries the 0-5V input signal from the photocell which is then scaled to a value used by the LPPK Software. Instructions for installing the LS5 Photocell follow.

- 1. After installing the Lumisys LS5 Photocell**, splice extension wires to photocell wires. If possible use the same color wires provided with the photocell. A maximum of 500 feet of wire total is allowed, measured from the photocell to the LX5 socket. Use 18-22AWG wire.
- 2. Remove power from LX5.**
- 3. Join red wires from all LS5 sensors into pigtails and terminate in single termination point marked "5V" on LX5 main board.**
- 4. Connect each yellow signal wire from each LS5 sensor into individually marked A1-A6 on LX5 main board.**
- 5. Join black wires from all LS5 sensors into pigtails and terminate in single termination point marked "G" on main board.**
- 6. Reconnect power to the LX5.**

Figure 14

Location of LS5 Photocell Input Socket on MX Series LX5

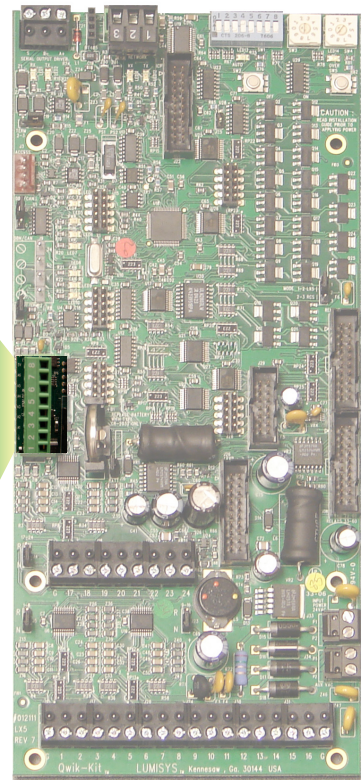
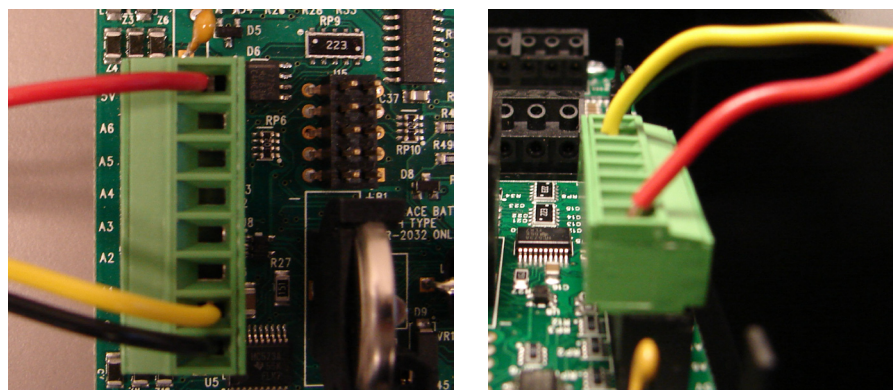

Figure 15



### Adding and Removing LTR Relays

#### To Remove a LTR Relay

The MX Series contains Lumisys LTR relays which provide the benefit of simple removal and installation. Relay components are shown in **Figure 17**. For more information on the LTR relay refer to the MX Data Sheet obtainable from our website.

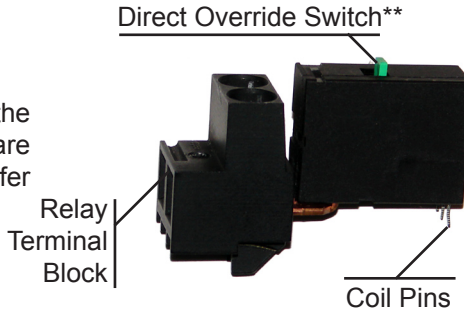

**Figure 17**  
Lumisys LTR

- 1. Disconnect power to the LX5.** Refer to **Figure 4** of this installation guide for the power connection location to the LX5.
- 2. If the relay is located behind the LX5, open the LX5 hinged backplate.**  
Open the LX5 by loosening the two thumbscrews. See **Figure 18**.
- 3. Remove branch circuit wires at the relay terminal block.**  
Refer to "Connecting Branch Circuit Wires" of this installation guide.
- 4. Remove the relay.** The relay is held in place by one screw as shown in **Figure 19**. Remove the screw to remove the relay. Pull the relay out in the direction perpendicular to the panel. Be careful not to damage the relay coil pins when removing.
- 5.** If a new relay will be placed in the position of the removed relay, proceed to Step 5 under "To add a relay" below. Otherwise, close the LX5 backplate.
- 6. Reconnect power to the LX5.** If you are immediately replacing the removed relay, do not disconnect power.

**Figure 18** Thumbscrews

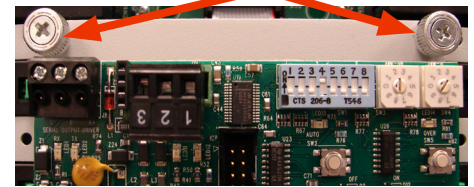

**Figure 19**

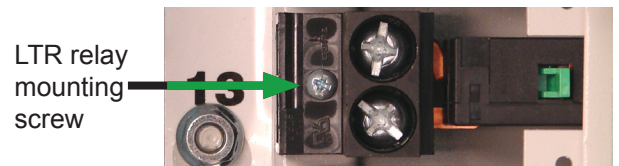

#### To Add a LTR Relay

- 1. Disconnect power to the LX5.** See **Figure 4** of this installation guide.
- 2. If the relay is located behind the LX5, open the backplate by loosening the two thumbscrews.** Refer to **Figure 18** for the location of the thumbscrews.
- 3. Remove the relay blank.** The relay blank is factory mounted in MX Series panels where relay capacity of the unit exceeds the number of relays ordered. The blank is removed by loosening the one screw.
- 4. Install the relay.** Insert the relay coil pins into the coil pin socket while seating the terminal block of the relay onto its mounting screw standoff. Be careful not to bend the coil pins during installation. Fasten the relay by tightening its mounting screw. See **Figure 20**.
- 5. Install branch circuit wires.** Refer to "Connecting Branch Circuit Wires" of this installation guide.
- 6. Close the LX5 hinged backplate** if necessary, and reconnect power to the LX5.

**Figure 20**

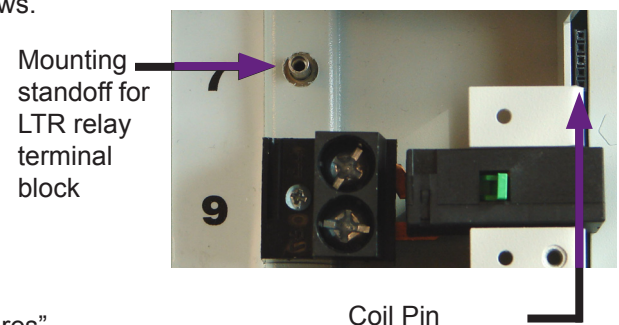

### Connecting to Digi-Touch Addressable Switch Network

Make all connections before applying power to the LX5 main board. Connect the network of switches to the LX5 port marked DDN/ CAN and set the jumper to DDN (upper 2 pins) as shown in picture below. Remove terminal block to view Pcb markings designating pins " 24, I, H, and G". The LX5 can be used to loop power up to 8 two button DigiTouch switches or up to 16 one-button DigiTouch switches. For higher quantities of switches, use 24VCD auxiliary power supply. Refer to DigiTouch Installation Guide for details.

**Terminal Block**

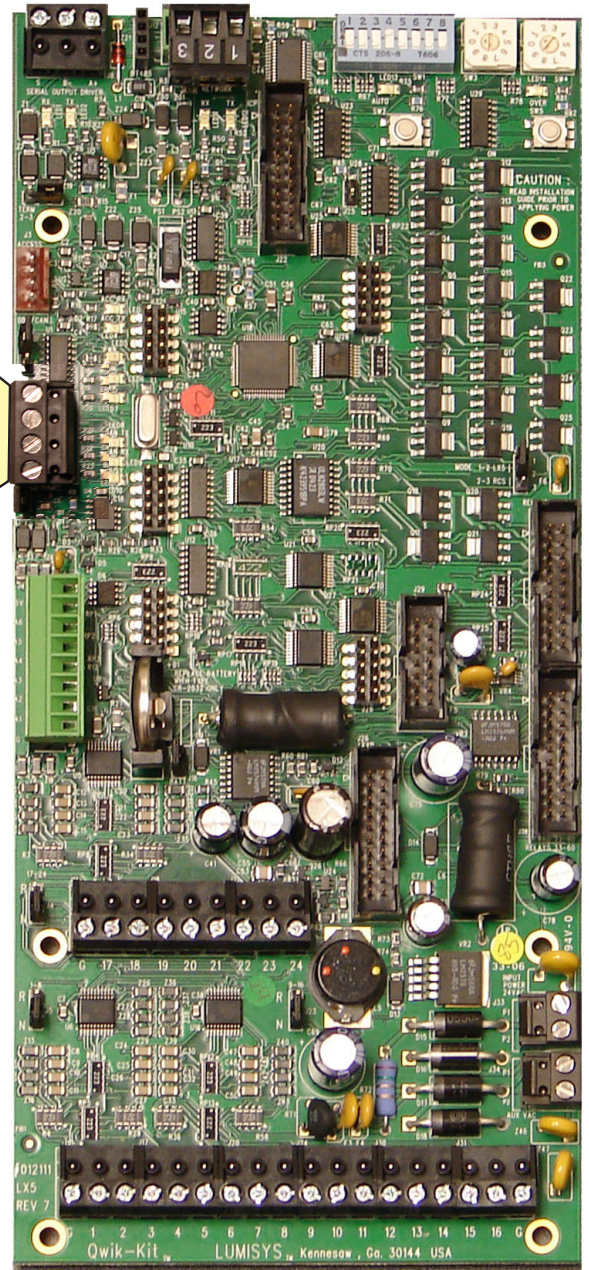
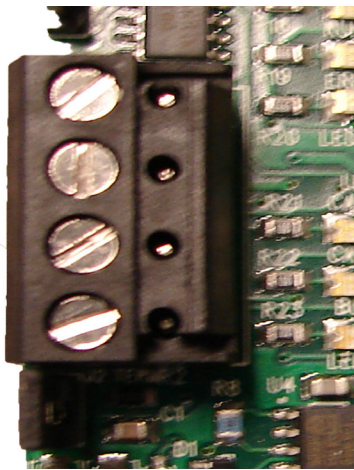

**Jumper**

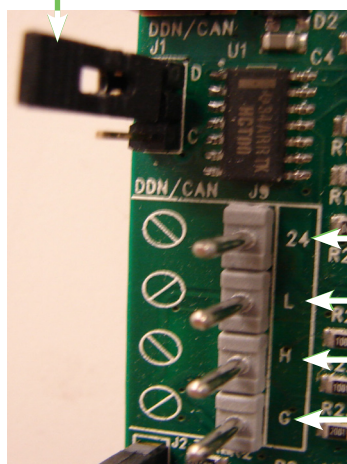
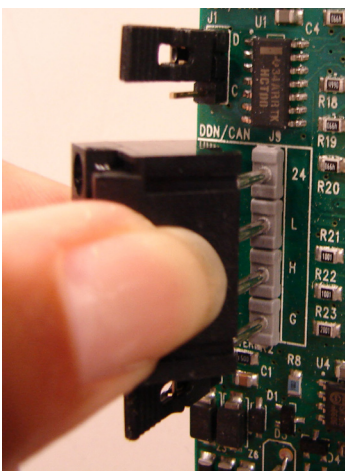

- 24
- L
- H
- G



### Terms and Conditions of Sale

**AGREEMENT OF SALE:** Acceptance by Lumisys, (hereinafter "Seller") of any order, placed for the goods described on the Acknowledgment, Invoice or Sales Contract hereof shall be subject to Seller's Standard Terms and Conditions of Sale and is conditioned upon the Buyer's acceptance of these Standard Terms and Conditions of sale as stated on this Sales Contract.

**TERMS OF CONTRACT:** Any terms or conditions of the Buyer's order which are inconsistent with these Standard Terms and Conditions shall not be binding on the Seller and shall not be considered applicable to the sale or shipment of goods covered by this Acknowledgment, Invoice, or Sales Contract. **PRICES:** Prices are subject to change to the extent permissible under applicable federal law. Sales contracts which call for delivery in the future will be billed at prices in effect at the time of shipment. Shipping weights shown are approximate and subject to change without notice. Seller shall notify buyer of any significant changes in weight.

**SHIPMENT AND PAYMENTS:** All prices are F.O.B. Seller's plant in Kennesaw, Georgia. No freight is allowed on any shipments. Shipments and deliveries hereunder shall at all times be subject to the approval of Seller's Credit Department. Seller may, at any time, require payment in advance or satisfactory security or guarantee that invoices will be promptly paid when due. If Buyer fails to comply with any terms of payment, Seller, in addition to its rights and remedies but not in limitation thereof, reserves the right to withhold further deliveries or terminate this Agreement, and any unpaid amount thereon shall become due immediately. Terms of payment shall be as set forth on the face hereof. Unless approved by Seller, all overseas shipments shall require prepayment by wire transfer or an irrevocable letter of credit from Buyer.

**FORCE MAJEURE:** Delays or defaults in delivery by Seller of the goods covered by this Sales Contract shall be excused as Force Majeure so far as the same is caused by fire, strikes, accident, war, natural disasters, acts of God, terrorism, explosions, death, vandalism, armed robbery, theft, breakage of machinery, governmental regulation, or any other events which were unavoidable or caused by events which are beyond the reasonable control of Seller. In no event shall Seller be liable for any consequential, special, or contingent damages on account of any default or delay in delivery from any Force Majeure event. If any Force Majeure event occurs which may affect Buyer's goods, Seller shall give prompt oral and written notice of its Force Majeure declaration to Buyer within 7 days or as soon as is practicable.

**NON-CANCELLATION:** Orders are not subject to suspension, reduction, or cancellation, except on terms that will indemnify Seller against loss. **SPECIFICATIONS:** Seller relies on specifications and other data furnished by the Buyer, architect, contractors, and/or consulting engineer in all phases of the work covered by this Acknowledgment, Invoice or Sales Contract. Seller shall be responsible to check quantities only. Alterations, changes in specifications, approval of samples, and/or changes in delivery shall not be binding upon Seller unless approved by Seller in advance. In the event Buyer asks Seller to perform design or engineering work for any and all phases of the work covered by this Acknowledgment, Invoice or Sales Contract, Seller shall not be responsible for any damages claimed by the Buyer as a result of alleged errors or defects in such design or engineering work except for gross negligence on the part of Seller.

**WARRANTY AND LIMITATION OF LIABILITY:** Seller warrants that the goods supplied by it have been manufactured in accordance with its standard manufacturing practices, are non-defective and conform to the contract or catalog description for such goods. Except as stated herein, Seller makes no express warranty with respect to goods supplied by it and Seller makes no implied warranties of suitability or fitness for any particular purpose. Unauthorized or unapproved modifications or alterations of such goods without the express written approval of Seller shall void all warranties and indemnities granted herein. To satisfy its indemnity and warranty obligations, Seller will, at its sole option, credit, repair or replace, any goods supplied by it which its examination shall disclose to its satisfaction are defective in workmanship or material, and are returned to it within two years from the date of shipment. Any claim not made within this period shall be conclusively deemed waived by Buyer. Seller shall not be liable for any consequential, special, incidental, punitive or contingent damage or expense arising directly or indirectly from any defect in its goods or from the use of any defective goods or otherwise arising out of this Contract or any purchase order. The remedies set forth herein shall constitute the exclusive remedies available to Buyer for Seller's indemnity and warranties and are in lieu of all other remedies that would otherwise be available to Buyer.

Warranty and technical support on Lumisys products are only available after payment has been received in full.

**RETURNS:** Material returned for credit is subject to a 10% restocking charge. Freight or other costs incurred in restocking will be added. Returns resulting from errors by the Seller will not be subject to the charge. Returned materials shall be received in condition for resale as new equipment to qualify for credit. Returned materials must be returned to the Seller within 30 days of receipt and shall only be accepted with prior authorization.

**SELLER RESERVES THE RIGHT TO SUBSTITUTE MATERIALS USED IN CONSTRUCTION OR EQUIPMENT SOLD PROVIDED SAID SUBSTITUTION DOES NOT MODIFY THE OPERATIONAL CHARACTERISTICS OF THE EQUIPMENT SOLD.**

**THESE TERMS OF SALE MAY BE MODIFIED WITHOUT NOTICE. THE TERMS OF SALE IN EFFECT AT THE TIME OF SALE SHALL APPLY. THE SELLER AS REFERRED TO IN THE TERMS OF SALE IS Lumisys.**

**CLAIMS:** Claims for shortages of goods or for mistakes or errors in billing must be presented within forty-five (45) days from the date of goods; and must state the packing slip number and container number applicable to the claim. Any claim not so presented shall be conclusively deemed waived.

**TAXES:** Any federal, state, local or government tax or charge on the sale, shipment, or installation of the goods covered by the Acknowledgment, Invoice or Sales Contract, shall be added to the price and paid by Buyer or, in lieu thereof, the Buyer shall furnish Seller with tax-exemption certificates acceptable to the taxing authority. Buyer agrees to reimburse and save Seller harmless from all such state and local taxes, including interest and penalties thereon, which may at any time be payable to any governmental unit with respect to the sale of any goods covered by this Acknowledgment, Invoice or Sales Contract.

**CREDIT BALANCE:** Any credit memos granted to Buyer from Seller arising out of returned goods or other circumstances, which are not subsequently requested or applied to the purchase of other goods from Seller within twelve months from the date credit was granted, shall become the property of Seller.

**APPLICABLE LAW:** All questions arising out of this Acknowledgment, Invoice or Sales Contract, which shall be deemed a Georgia contract, shall be governed by the laws of the State of Georgia. Venue for any disputes arising out of this agreement shall be in Georgia. All disputes arising out of this agreement shall be resolved in the following fashion: the parties shall first engage in good-faith negotiation. If the parties are unable to settle their claims through good-faith negotiation, the parties shall attempt to resolve their dispute through mediation by an agreed upon mediator. Lastly, if mediation fails, the parties shall be subject to binding arbitration by an agreed upon arbitrator who is a member of the American Arbitration Association. The prevailing party in any arbitration or other legal action arising out of this agreement, and/or these terms and conditions of sale, shall be entitled to indemnification of all its attorneys' fees, litigation expenses, and costs from the losing party.

**EXCLUSIVE TERMS:** This Acknowledgment, Invoice or Sales Contract, which includes these Standard Terms and Conditions, shall constitute the final and binding contract between the parties and shall take precedence over any other terms and conditions from the Buyer. Any changes or deviations from this Acknowledgment, Invoice or Sales Contract must be in writing and mutually agreed to by Buyer and Seller.

**LIMITATION FOR SUITS:** Any controversy or claim arising out of, or relating to, this Acknowledgment, Invoice or Sales Contract, or the breach thereof, must be commenced within two (2) years after the cause of action accrued.