

CONNECTOR PINS - SWAGE MOUNT & RIGHT ANGLE

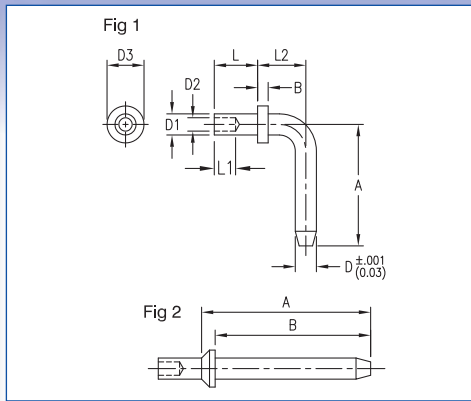

Dimensions in inches (mm)
See page 93/94 for recommended
Anvil and Punch

How to order code
460 - XXXX - XX - XX - 00

Basic Part No. | Finish

Material Code Table		
Component	Material	RoHS
Pin	Brass	✓

Finish Code Table		
Dash No.	Pin Finish	RoHS
-03	Gold over Nickel	✓
-04	Electro-Tin	✓
-05	Electro-Solder	X

Fig.	Basic Part No.	L	Board Thickness	L1	L2	A	B	D	D1	D2	D3	Mtg. Hole Diameter
1	460-1521 -01	.051 (1.30)	.031 (0.79)	.040 (1.02)	.080 (2.03)	.257 (6.53)	.020 (0.51)	.040 (1.02)	.040 (1.02)	.025 (0.64)	.070 (1.78)	.043 (1.09)
	-02	.082 (2.08)	.061 (1.57)									
	-03	.113 (2.87)	.094 (2.39)									
	460-1523 -01	.051 (1.30)	.031 (0.79)	.040 (1.02)	.200 (5.08)	.370 (9.40)	.170 (4.32)	.080 (2.03)	.090 (2.29)	.067 (1.70)	.156 (3.96)	.094 (2.39)
	-02	.082 (2.08)	.061 (1.57)									
	-03	.113 (2.87)	.094 (2.39)									
2	460-3889 -01	.047 (1.19)	.031 (0.79)	.031 (0.79)	-	.213 (5.41)	.188 (4.78)	.025 (0.64)	.030 (0.76)	.020 (0.51)	.062 (1.57)	.033 (0.84)
	460-3221 -01	.062 (1.57)	.031 (0.79)	.040 (1.02)	-	.240 (6.10)	.188 (4.78)	.045 (1.14)	.060 (1.52)	.042 (1.07)	.125 (3.18)	.064 (1.63)
	-02	.094 (2.39)	.061 (1.57)									
	-03	.125 (3.18)	.094 (2.39)									
	-04	.156 (3.96)	.125 (3.18)									

Electro-Mechanical Custom Design

Cambion are able to assist with Electro-Mechanical component design, either hybrid versions of standard products or to an application specific requirement, supported with fast turnaround of prototypes via its UK manufacturing activity. Additionally Cambion can offer full project management of connector and cable harness developments.

