

# Operating Instructions

## Videographic recorder LINAX A315

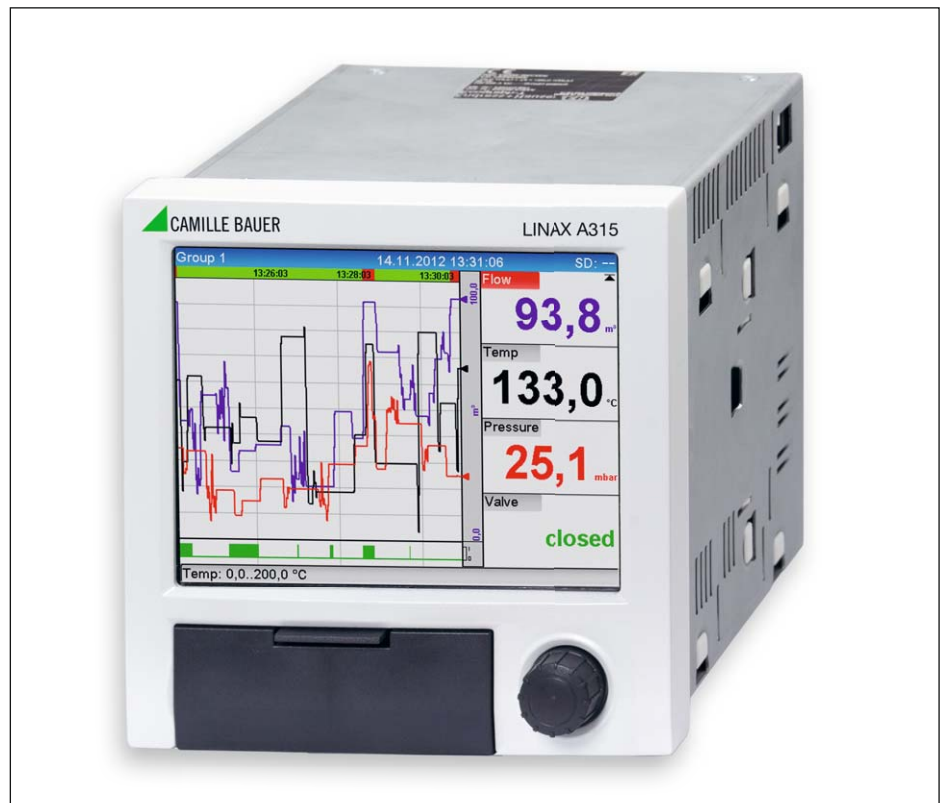

LINAX A315 Be

12.16

Camille Bauer Metrawatt AG  
Aargauerstrasse 7  
CH-5610 Wohlen/Switzerland  
Phone +41 56 618 21 11  
Fax +41 56 618 21 21  
info@cbmag.com  
www.camillebauer.com

 CAMILLE BAUER

## Brief overview

*For quick and easy commissioning:*

<b>Safety instructions</b>	(→ 7)
▼	
<b>Installation</b>	(→ 9)
▼	
<b>Electrical connection</b>	(→ 11)
▼	
<b>Operation options - Web server</b>	(→ 27)
▼	
<b>Commissioning / Setup via PC</b>	(→ 31)
Commissioning using the communication interface - Quick start for device configuration for standard operation	
<b>Customer-specific configuration</b>	(→ 67)

Complex measurement tasks require the configuration of additional functions, which the user can select, set and adapt to his/her process conditions by setting the appropriate device parameters. A detailed description of all functions and device parameters.

## Table of contents

<b>1</b>	<b>Document information</b> . . . . .	<b>5</b>	9.2	Switching on the measuring device . . . . .	31
1.1	Document function . . . . .	5	9.3	Setting the operating language . . . . .	31
1.2	Symbols used . . . . .	5	9.4	Configuring the measuring device (Setup menu) . . . . .	31
1.3	Documentation . . . . .	6	9.5	Advanced settings (Expert menu) . . . . .	33
<b>2</b>	<b>Basic safety instructions</b> . . . . .	<b>7</b>	9.6	Configuration management . . . . .	34
2.1	Requirements concerning the staff . . . . .	7	9.7	Simulation . . . . .	34
2.2	Designated use . . . . .	7	9.8	Protecting settings from unauthorized access . . . . .	35
2.3	Workplace safety . . . . .	7	<b>10</b>	<b>Operation</b> . . . . .	<b>36</b>
2.4	Operational safety . . . . .	7	10.1	Displaying and modifying current Ethernet settings . . . . .	36
2.5	Product safety . . . . .	8	10.2	Reading device locking status . . . . .	36
2.6	Safety information for table version (option) . . . . .	8	10.3	Reading measured values . . . . .	37
<b>3</b>	<b>Product description</b> . . . . .	<b>8</b>	10.4	Reading measured values via the web server . . . . .	37
3.1	Product design . . . . .	8	10.5	Data analysis and visualization using analysis software provided . . . . .	39
<b>4</b>	<b>Incoming acceptance and product identification</b> . . . . .	<b>8</b>	10.6	Changing the group . . . . .	39
4.1	Incoming acceptance . . . . .	8	10.7	SD card / USB stick . . . . .	40
4.2	Product identification . . . . .	9	10.8	Showing data logging . . . . .	40
4.3	Storage and transport . . . . .	9	10.9	Signal analysis . . . . .	40
<b>5</b>	<b>Installation</b> . . . . .	<b>9</b>	10.10	Changing the display mode . . . . .	41
5.1	Mounting requirements . . . . .	9	10.11	Adjusting the brightness of the display . . . . .	41
5.2	Mounting the measuring device . . . . .	10	<b>11</b>	<b>Diagnostics and troubleshooting</b> . . . . .	<b>42</b>
5.3	Post-mounting check . . . . .	11	11.1	General troubleshooting . . . . .	42
<b>6</b>	<b>Electrical connection</b> . . . . .	<b>11</b>	11.2	Troubleshooting . . . . .	42
6.1	Connection conditions . . . . .	11	11.3	Diagnostic information on the local display . . . . .	43
6.2	Connection instructions . . . . .	12	11.4	Pending, current diagnostic messages . . . . .	47
6.3	Connecting the measuring device . . . . .	12	11.5	Diagnosis list . . . . .	47
6.4	Post-connection check . . . . .	19	11.6	Event logbook . . . . .	47
<b>7</b>	<b>Operation options</b> . . . . .	<b>21</b>	11.7	Device information . . . . .	47
7.1	Overview of operation options . . . . .	21	11.8	Diagnostics of measured values . . . . .	47
7.2	Structure and function of the operating menu . . . . .	21	11.9	Diagnostics of outputs/relays . . . . .	47
7.3	Measured value display and operating elements . . . . .	24	11.10	Simulation . . . . .	48
7.4	Access to the operating menu via the local display . . . . .	27	11.11	Initializing the modem . . . . .	48
7.5	Device access via operating tools . . . . .	27	11.12	Resetting the measuring device . . . . .	48
<b>8</b>	<b>System integration</b> . . . . .	<b>29</b>	11.13	Firmware history . . . . .	49
8.1	Integrating the measuring device in the system . . . . .	29	<b>12</b>	<b>Maintenance</b> . . . . .	<b>49</b>
<b>9</b>	<b>Commissioning</b> . . . . .	<b>31</b>	12.1	Updating the device software ("firmware") . . . . .	49
9.1	Function check . . . . .	31	12.2	Instructions for enabling a software option . . . . .	49
			12.3	Cleaning . . . . .	49
			<b>13</b>	<b>Repair</b> . . . . .	<b>50</b>
			13.1	General notes . . . . .	50
			13.2	Spare parts . . . . .	50
			13.3	Return . . . . .	51
			13.4	Disposal . . . . .	52

<b>14</b>	<b>Accessories</b> .....	<b>53</b>
14.1	Device-specific accessories .....	53
14.2	Communication-specific Accessories .....	53
<b>15</b>	<b>Technical Data</b> .....	<b>54</b>
<b>16</b>	<b>Addition</b> .....	<b>67</b>
16.1	Operating items in the "Expert" menu .....	67
<b>Index</b>	.....	<b>146</b>

# 1 Document information

## 1.1 Document function





These Operating Instructions contain all the information that is required in various phases of the life cycle of the device: from product identification, incoming acceptance and storage, to mounting, connection, operation and commissioning through to troubleshooting, maintenance and disposal.

### Integrated Operating Instructions







The unit's simple control system enables you to perform commissioning for many applications without the need for hardcopy operating instructions. At the push of a button, the device displays operating instructions directly on the screen. These instructions are nevertheless delivered with the unit - they supplement the Operating Instructions in the unit. Anything that is not described directly at the device using plain text or selection lists is explained here.

## 1.2 Symbols used











### 1.2.1 Safety symbols

Symbol	Meaning
	<b>DANGER!</b> This symbol alerts you to a dangerous situation. Failure to avoid this situation will result in serious or fatal injury.
	<b>WARNING!</b> This symbol alerts you to a dangerous situation. Failure to avoid this situation can result in serious or fatal injury.
	<b>CAUTION!</b> This symbol alerts you to a dangerous situation. Failure to avoid this situation can result in minor or medium injury.
	<b>NOTICE!</b> This symbol contains information on procedures and other facts which do not result in personal injury.





### 1.2.2 Electrical symbols

Symbol	Meaning
	<b>Direct current</b> A terminal to which DC voltage is applied or through which direct current flows.
	<b>Alternating current</b> A terminal to which alternating voltage is applied or through which alternating current flows.
	<b>Direct current and alternating current</b> <ul style="list-style-type: none"> <li>▪ A terminal to which alternating voltage or DC voltage is applied.</li> <li>▪ A terminal through which alternating current or direct current flows.</li> </ul>
	<b>Ground connection</b> A grounded terminal which, as far as the operator is concerned, is grounded via a grounding system.
	<b>Protective ground connection</b> A terminal which must be connected to ground prior to establishing any other connections.
	<b>Equipotential connection</b> A connection that has to be connected to the plant grounding system: This may be a potential equalization line or a star grounding system depending on national or company codes of practice.

### 1.2.3 Symbols for certain types of information

Symbol	Meaning
 A0011182	<b>Allowed</b> Indicates procedures, processes or actions that are allowed.
 A0011183	<b>Preferred</b> Indicates procedures, processes or actions that are preferred.
 A0011184	<b>Forbidden</b> Indicates procedures, processes or actions that are forbidden.
 A0011193	<b>Tip</b> Indicates additional information.
 A0011194	<b>Reference to documentation</b> Refers to the corresponding device documentation.
 A0011195	<b>Reference to page</b> Refers to the corresponding page number.
 A0011196	<b>Reference to graphic</b> Refers to the corresponding graphic number and page number.
	<b>Series of steps</b>
	<b>Result of a sequence of actions</b>
 A0013562	<b>Help in the event of a problem</b>

### 1.2.4 Symbols in graphics

Symbol	Meaning
<b>1, 2, 3,...</b>	Item numbers
	Series of steps
<b>A, B, C, ...</b>	Views
<b>A-A, B-B, C-C, ...</b>	Sections
 A0013441	Flow direction
 A0011187	<b>Hazardous area</b> Indicates a hazardous area.
 A0011188	<b>Safe area (non-hazardous area)</b> Indicates a non-hazardous area.

## 1.3 Documentation

Document	Purpose and content of the document
Brief Operating Instructions KA011500/09/en	<b>Guide that takes you quickly to the 1st measured value</b> The Brief Operating Instructions contain all the essential information from incoming acceptance to initial commissioning.

## 2 Basic safety instructions

Reliable and safe operation of the device is guaranteed only if the user reads these Operating Instructions and complies with the safety instructions they contain.

### 2.1 Requirements concerning the staff

The personnel for installation, commissioning, diagnostics and maintenance must fulfill the following requirements:

- ▶ Trained, qualified specialists: must have a relevant qualification for this specific function and task
- ▶ Are authorized by the plant owner/operator
- ▶ Are familiar with federal/national regulations
- ▶ Before beginning work, the specialist staff must have read and understood the instructions in the Operating Instructions and supplementary documentation as well as in the certificates (depending on the application)
- ▶ Following instructions and basic conditions

The operating personnel must fulfill the following requirements:

- ▶ Being instructed and authorized according to the requirements of the task by the facility's owner-operator
- ▶ Following the instructions in these Operating Instructions

### 2.2 Designated use

This device is designed for the electronic acquisition, display, recording, analysis, remote transmission and archiving of analog and digital input signals in non-hazardous areas.

- The manufacturer accepts no liability for damages resulting from incorrect use or use other than that designated. It is not permitted to convert or modify the device in any way.
- The device is designed for installation in a panel and must only be operated in an installed state.

### 2.3 Workplace safety

For work on and with the device:

- ▶ Wear the required personal protective equipment according to federal/national regulations.

### 2.4 Operational safety

Risk of injury.

- ▶ Operate the device in proper technical condition and fail-safe condition only.
- ▶ The operator is responsible for interference-free operation of the device.

#### Conversions to the device

Unauthorized modifications to the device are not permitted and can lead to unforeseeable dangers.

- ▶ If, despite this, modifications are required, consult with the manufacturer.

#### Repair

To ensure continued operational safety and reliability,

- ▶ Carry out repairs on the device only if they are expressly permitted.
- ▶ Observe federal/national regulations pertaining to repair of an electrical device.
- ▶ Use original spare parts and accessories from the manufacturer only.

### **Hazardous area**

To eliminate a danger for persons or for the facility when the device is used in the hazardous area (e.g. explosion protection, pressure vessel safety):

- ▶ Based on the nameplate, check whether the ordered device is permitted for the intended use in the hazardous area.
- ▶ Observe the specifications in the separate supplementary documentation that is an integral part of these Instructions.

## **2.5 Product safety**

This measuring device is designed in accordance with good engineering practice to meet state-of-the-art safety requirements, has been tested, and left the factory in a condition in which it is safe to operate.

It meets general safety standards and legal requirements. It also complies with the EC directives listed in the device-specific EC Declaration of Conformity. The manufacturer confirms this by affixing the CE mark to the device.

## **2.6 Safety information for table version (option)**

- The mains plug should only be inserted into a socket with a ground contact.
- The protective effect may not be suspended by an extension cable without a protective ground.
- Relay outputs:  $U(\text{max}) = 30 \text{ V rms (AC)} / 60 \text{ V (DC)}$

# **3 Product description**

## **3.1 Product design**

This device is best suited for the electronic acquisition, display, recording, analysis, remote transmission and archiving of analog and digital input signals.

The device is intended for installation in a panel or cabinet. There is also the option of operating it in a table-mounted or field-mounted housing.

# **4 Incoming acceptance and product identification**

## **4.1 Incoming acceptance**

On receipt of the goods, check the following points:

- Is the packaging or the content damaged?
- Is the delivery complete? Compare the scope of delivery against the information on your order form.

### **4.1.1 Scope of delivery**

The scope of delivery of the device comprises:

- Device (with terminals, as per your order)
- 2 fastening clips
- USB cable



- Optional: Industrial grade SD card (card is located in the device)
- Analysis software on CD-ROM
- Delivery note
- Multilanguage Operating Instructions on CD-ROM

 Anything missing? Then please inform your supplier.

## 4.2 Product identification

### 4.2.1 Nameplate

Compare the nameplate with the following diagram:

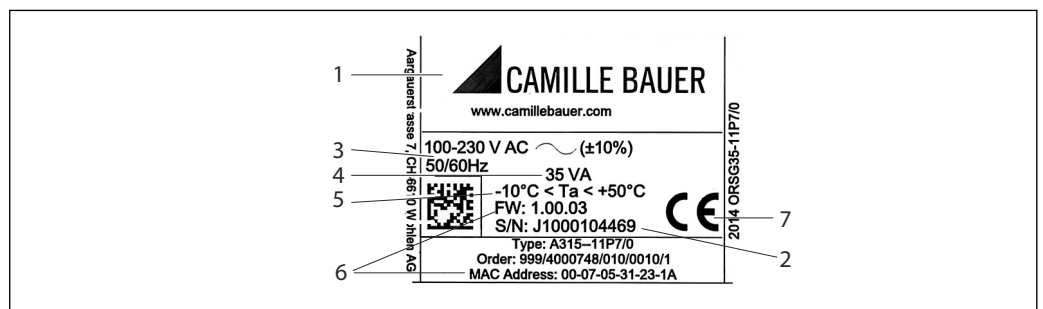

A0020253

 1 Device nameplate (example)

- 1 Device designation
- 2 Serial number
- 3 Power supply, mains frequency
- 4 Power consumption
- 5 Temperature range
- 6 Software version; MAC address
- 7 Device approvals

## 4.3 Storage and transport

Compliance with the permitted environmental and storage conditions is mandatory. Precise specifications are provided in the "Technical data" section of the Operating Instructions. (→  54)

Please note the following:

- Pack the device so that is protected against impact for storage and transport. The original packaging provides optimum protection.
- The permitted storage temperature is  $-20$  to  $+60$  °C ( $-4$  to  $+140$  °F).

## 5 Installation

### 5.1 Mounting requirements

#### NOTICE

**Overheating due to buildup of heat in the device**

- ▶ To avoid heat buildup, please always ensure that the device is sufficiently cooled.

The device is designed for use in a panel in non-hazardous areas.

- Ambient temperature range -10 to +50 °C (14 to 122 °F)
- Climate class as per IEC 60654-1: Class B2
- Degree of protection: IP65, NEMA 4 at front / IP20 housing at rear

### 5.1.1 Installation dimensions

Please observe the installation depth of approx. 158 mm (6.22 in) for the device incl. terminals and fastening clips.

- Panel cutout: 138 to 139 mm (5.43 to 5.47 in) x 138 to 139 mm (5.43 to 5.47 in)
- Panel strength: 2 to 40 mm (0.08 to 1.58 in)
- Angle of vision: from the midpoint axis of the display, 75° to the left and right, 65° above and below.
- A minimum distance of 15 mm (0.59 in) mm (inch) between the devices must be observed if aligning the devices in the Y-direction (vertically above one another). A minimum distance of 10 mm (0.39 in) mm (inch) between the devices must be observed if aligning the devices in the X-direction (horizontally beside one another).
- Securing to DIN 43 834

## 5.2 Mounting the measuring device

 Mounting tool: For installation in the panel, all you need is a screwdriver.

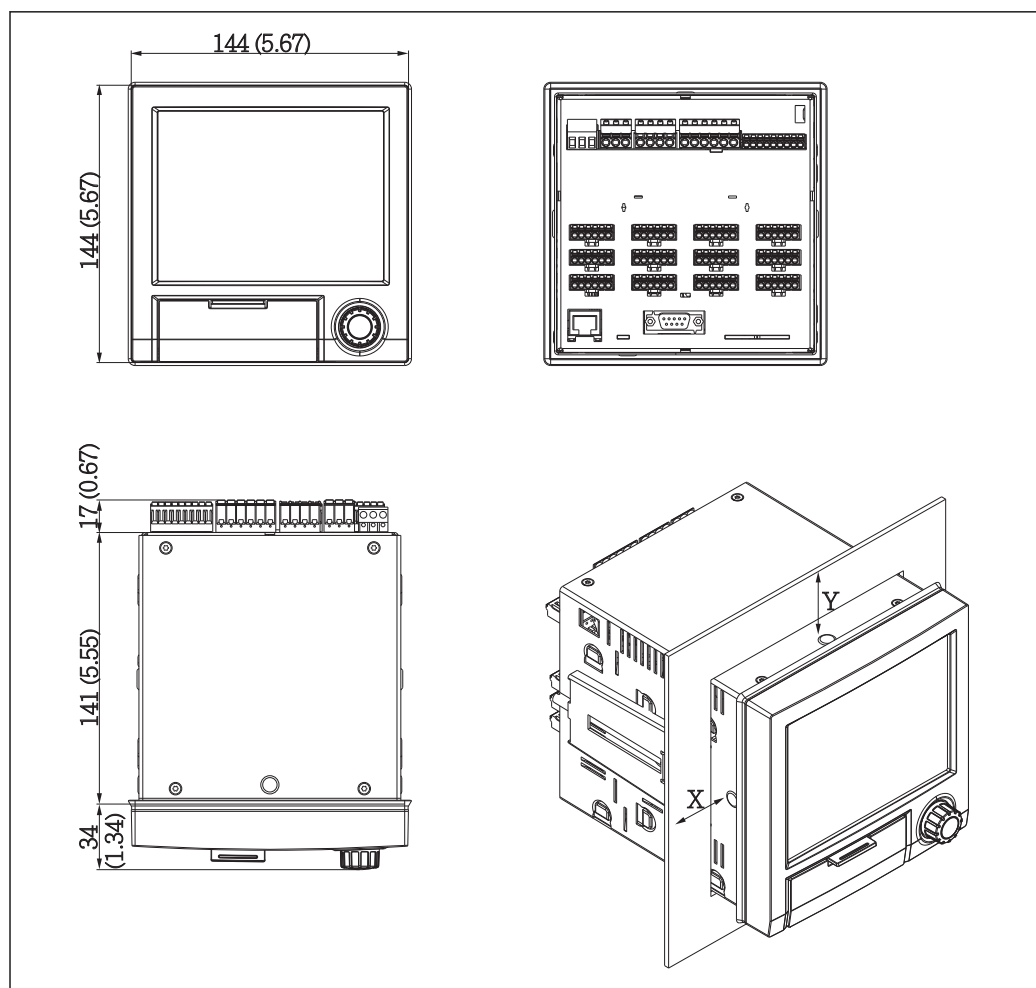

A0019301

 2 Panel mounting and dimensions in mm (Inch)

1. Push the device through the panel cutout from the front. To avoid heat buildup, maintain a distance of > 15 mm (>0.59 in) from walls and other devices.
2. Hold the device level and hang the fastening clips in the openings (1 x left, 1 x right).
3. Evenly tighten the screws on the fastening clip using a screwdriver to guarantee a secure seal to the control panel (torque 100 Ncm).

### 5.3 Post-mounting check

- Is the sealing ring undamaged?
- Does the seal run all around the housing collar?
- Are the threaded rods properly tightened?
- Is the device fixed firmly in the center of the control panel cutout?

## 6 Electrical connection

### 6.1 Connection conditions

#### WARNING

##### **Danger! Electric voltage!**

- ▶ The entire connection of the device must take place while the device is de-energized.
- ▶ The mixed connection of safety extra-low voltage and dangerous contact voltage to the relay is **not** permitted.

Danger if protective ground is disconnected

- ▶ The ground connection must be made before all other connections.

#### NOTICE

##### **Cable heat load**

- ▶ Use suitable cables for temperatures of 5 °C (9 °F) above ambient temperature.

Incorrect supply voltage can damage the device or cause malfunctions

- ▶ Before commissioning the device, make sure that the supply voltage matches the voltage specifications on the nameplate.

Check emergency shutdown for device

- ▶ Provide suitable switch or circuit breaker in building installation. This switch must be provided close to the device (within easy reach) and marked as a circuit breaker.

Protect the device from overload

- ▶ Provide overload protection (nominal current = 10 A) for power cable.

Incorrect wiring may result in the device being destroyed

- ▶ Note terminal designation on the rear of the device.

Energy-rich transients in the case of long signal lines

- ▶ Install suitable overvoltage protection (e.g. E+H HAW562) upstream.

## 6.2 Connection instructions

### 6.2.1 Cable specification

#### Cable specification, spring terminals

All connections to the rear of the unit are designed as screw or spring terminal blocks with reverse polarity protection. This makes the connection very quick and easy. The spring terminals are unlocked with a slotted screwdriver (size 0).

Please note the following when connecting:

- Wire cross-section, auxiliary voltage output, digital I/O and analog I/O: max. 1.5 mm<sup>2</sup> (14 AWG) (spring terminals)
- Wire cross-section, power supply: max. 2.5 mm<sup>2</sup> (13 AWG) (screw terminals)
- Wire cross-section, relays: max. 2.5 mm<sup>2</sup> (13 AWG) (spring terminals)
- Stripping length: 10 mm (0.39 in)

 No ferrules have to be used when connecting flexible wires to spring terminals.

#### Cable type

 Use shielded signal lines for interfaces!

## 6.3 Connecting the measuring device

### 6.3.1 Terminal assignment on the rear of the device

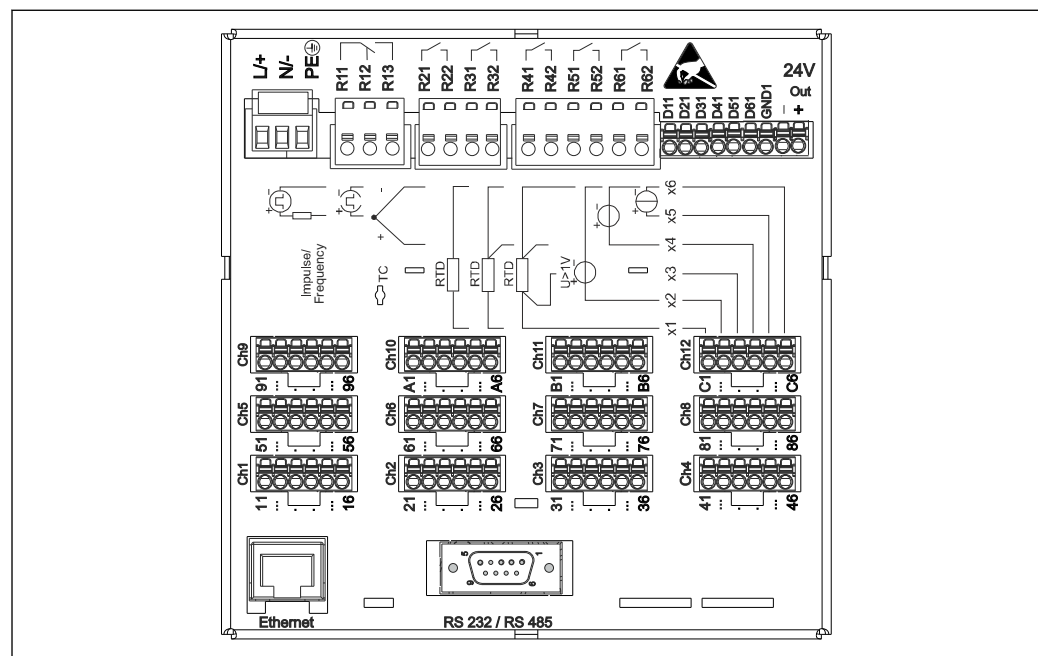

A0019304

 3 Terminals on the rear of the device

### 6.3.2 Supply voltage

Power unit type	Terminal		
100-230 VAC	L+	N-	PE
	Phase L	Zero conductor N	Ground
24 V AC/DC	L+	N-	PE
	Phase L or +	Zero conductor N or -	Ground

### 6.3.3 Relay

Type	Terminal (max. 250 V, 3 A)				
Alarm relay 1	R11	R12	R13		
	Changeover contact	Normally closed contact (NC) <sup>1)</sup>	Normally open contact (NO) <sup>2)</sup>		
Relay 2 to 6				Rx1	Rx2
				Switching contact	Normally open contact (NO) <sup>2)</sup>

- 1) NC = normally closed (breaker)
- 2) NO = normally open (maker)

### 6.3.4 Digital inputs; auxiliary voltage output

Type	Terminal			
Digital input 1 to 6	D11 to D61	GND1		
	Digital input 1 to 6 (+)	Mass (-) for digital inputs 1 to 6		
Auxiliary voltage output, not stabilized, max. 250 mA			24V Out -	24V Out +
			- Mass	+ 24V (±15%)

### 6.3.5 Analog inputs

The first digit (x) of the two-digit terminal number corresponds to the associated channel:

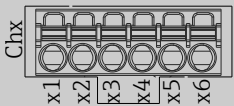
Type	Terminal					
	x1	x2	x3	x4	x5	x6
						
Current/pulse/frequency input					(+)	(-)
Voltage > 1V		(+)				(-)
Voltage ≤ 1V				(+)		(-)
Resistance thermometer RTD (2-wire)	(A)					(B)
Resistance thermometer RTD (3-wire)	(A)			b (sense)		(B)
Resistance thermometer RTD (4-wire)	(A)		a (sense)	b (sense)		(B)
Thermocouples TC				(+)		(-)

### 6.3.6 Connection example: Auxiliary voltage output as transmitter power supply for 2-wire sensors

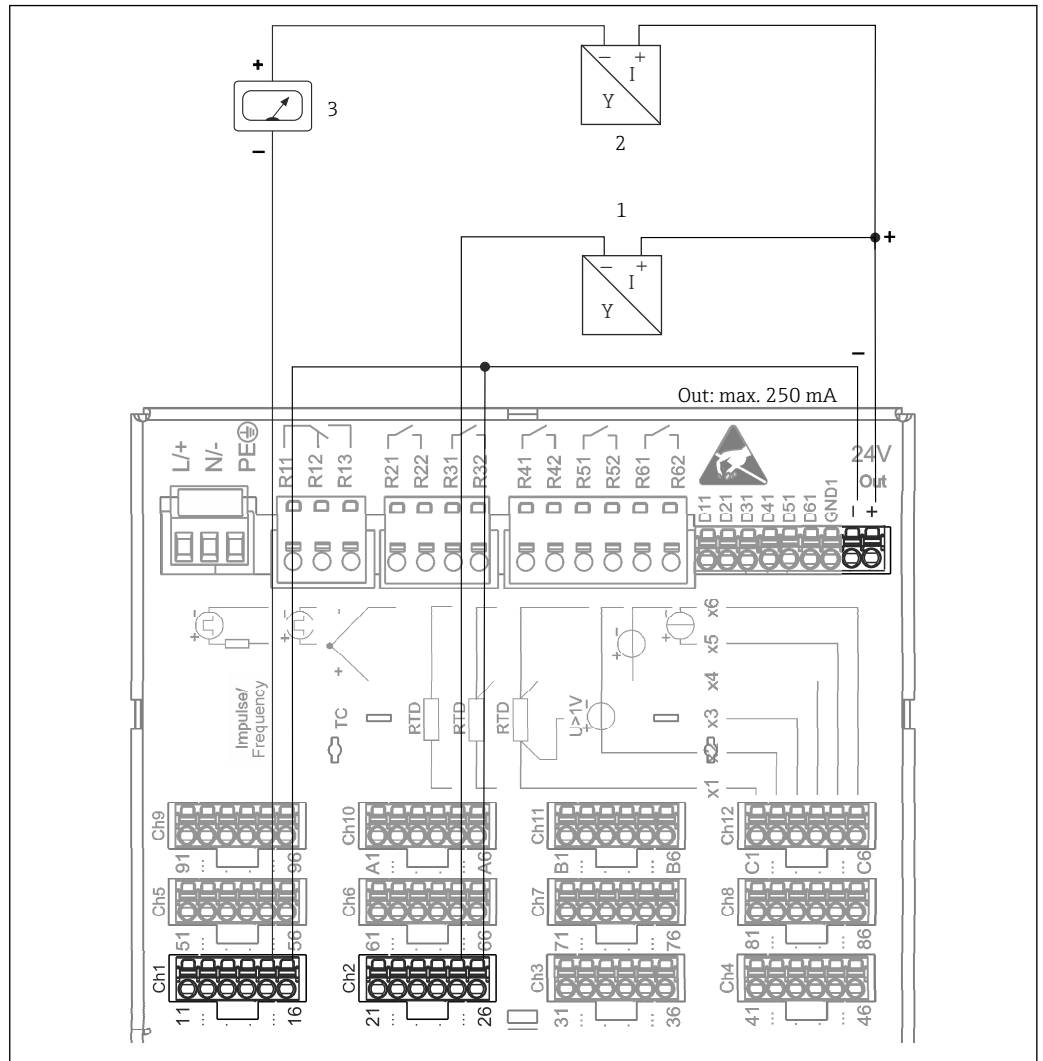

A0020259

4 Connecting auxiliary voltage output when using as a transmitter power supply for 2-wire sensors in the current measuring range (When connecting channel CH3-12, see pin assignment CH1-2.)

- 1 Sensor 1
- 2 Sensor 2
- 3 External indicator (optional)

### 6.3.7 Connection example: Auxiliary voltage output as transmitter power supply for 4-wire sensors

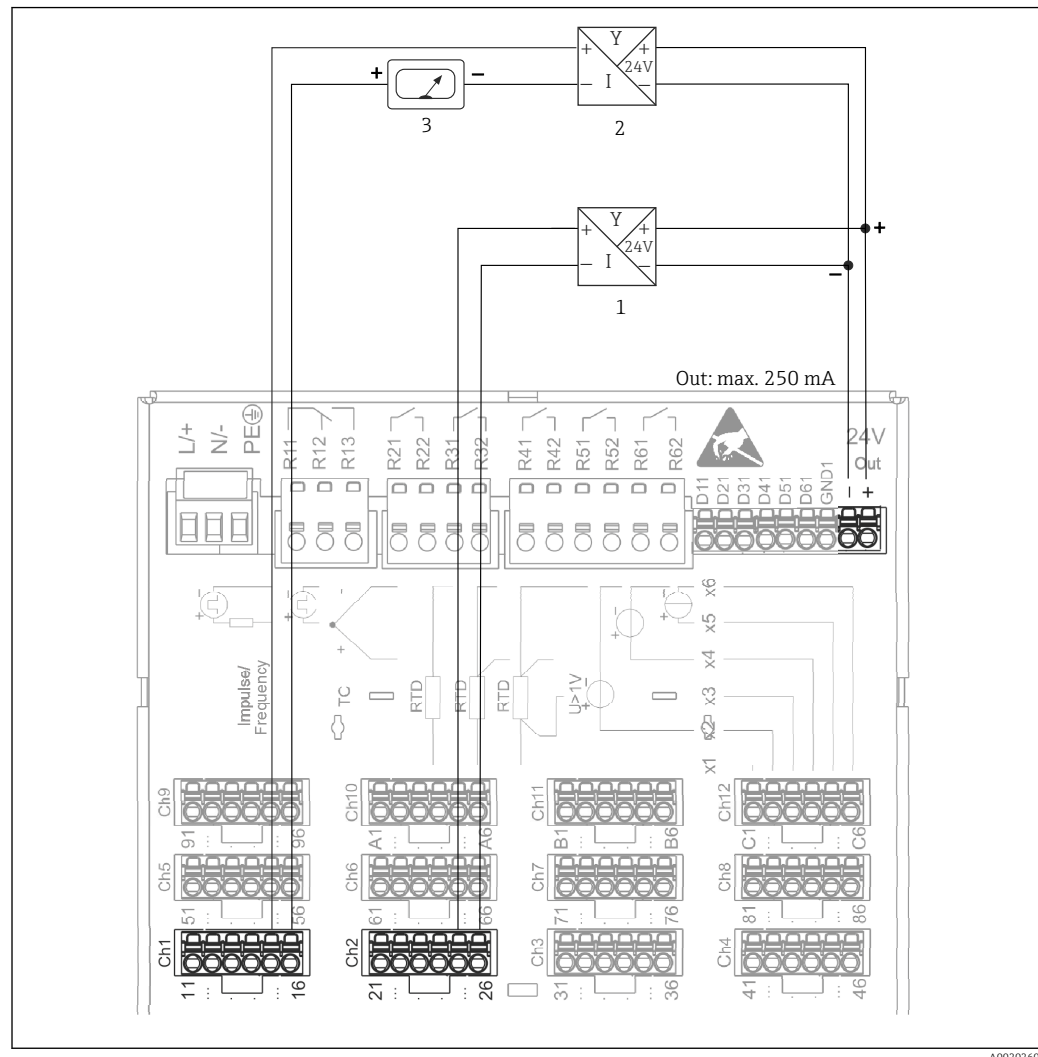

5 Connecting auxiliary voltage output when using as a transmitter power supply for 4-wire sensors in the current measuring range (When connecting channel CH3-12, see pin assignment CH1-2.)

- 1 Sensor 1
- 2 Sensor 2
- 3 External indicator (optional)

### 6.3.8 Option: RS232/RS485 interface (rear of device)

**i** Use shielded signal lines for serial interfaces!

A combined RS232/RS485 connection is available on a shielded SUB D9 socket at the rear of the device. This can be used for data or program transfer and to connect a modem. For communication via modem, we recommend an industrial modem with a watchdog function.



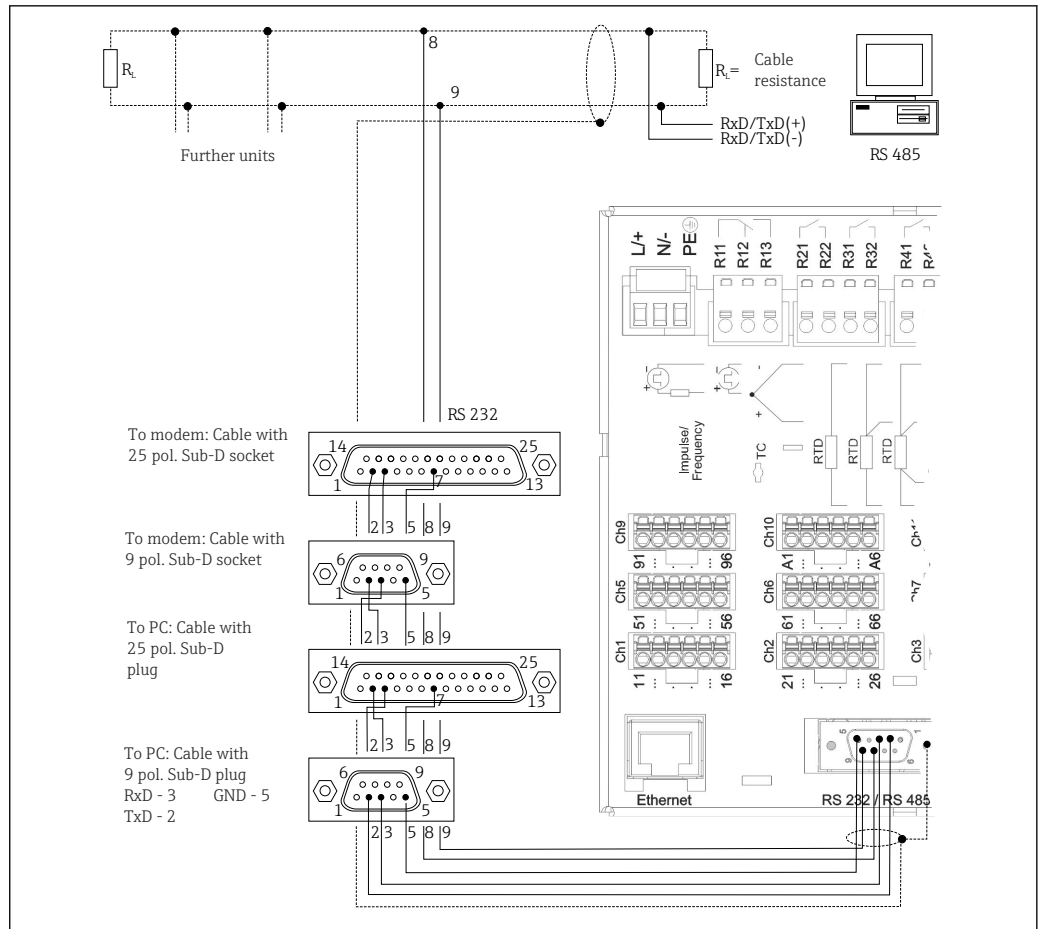

A0019305-EN

Type	Pin of the SUB-D9 socket								
	1	2	3	4	5	6	7	8	9
<b>RS232 assignment</b>		TxD (data output)	RxD (data input)		GND				
<b>RS485 assignment</b>					GND			RxD/TxD -	RxD/TxD +

Unoccupied connections should be left empty.  
 Maximum cable length:  
 RS232: 2 m (6.6 ft)  
 RS485: 1000 m (3280 ft)

**i** Only one interface can be used at any one time (RS232 or RS485).

### 6.3.9 Ethernet connection (rear of device)

The Ethernet interface can be used to integrate the device via a hub or switch into a PC network (TCP/ IP Ethernet). A standard patch cable (e.g. CAT5E) can be used for the connection. Using DHCP, the device can be fully integrated into an existing network without the need for additional configuration. The device can be accessed from every PC in the network.

- Standard: 10/100 Base T/TX (IEEE 802.3)
- Socket: RJ-45
- Max. cable length: 100 m
- Galvanic isolation; testing voltage: 500 V

**Meaning of the LEDs**

Beneath the Ethernet connection (see rear of device) there are two light emitting diodes which indicate the status of the Ethernet interface.

- Yellow LED: link signal; is lit when the device is connected to a network. If this LED is not illuminated then communication is impossible.
- Green LED: Tx/Rx; flashes irregularly if the device is transmitting or receiving data.

**6.3.10 Option: Ethernet Modbus TCP slave**

The Modbus TCP interface is used to connect to higher-ranking SCADA systems (Modbus master) to transmit all measured values and process values. Up to 12 analog inputs and 6 digital inputs can be transmitted via Modbus and stored in the device. From a physical point of view, the Modbus TCP interface is identical to the Ethernet interface.

**6.3.11 Option: Modbus RTU slave**

The Modbus RTU (RS485) interface is galvanically isolated (testing voltage: 500 V) and is used to connect to higher-ranking systems to transmit all measured values and process values. Up to 12 analog inputs and 6 digital inputs can be transmitted via Modbus and stored in the device. Connection is via the combined RS232/RS485 interface.

 Modbus TCP and Modbus RTU cannot be used at the same time.

**6.3.12 Connections at front of device**

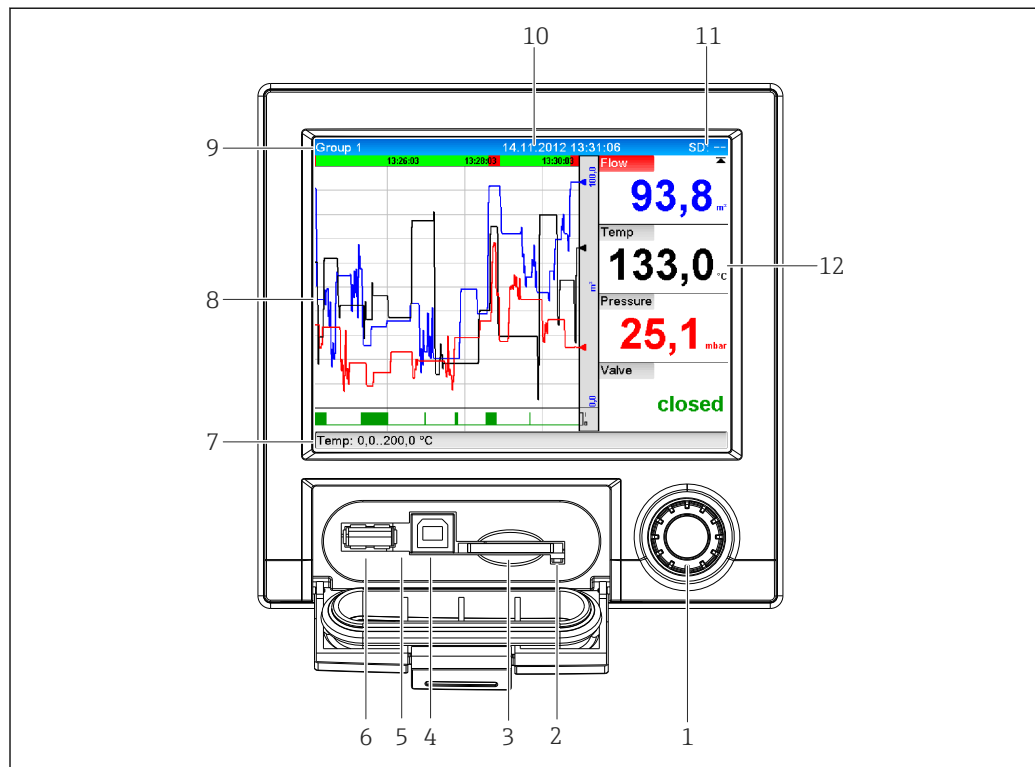

 6 Front of device with open flap

- 1 Navigator
- 2 LED at SD slot. Orange LED lit when the device writes to the SD card or reads it.
- 3 Slot for SD card
- 4 USB B socket "Function" e.g. to connect to PC or laptop
- 5 Green LED lit: Power supply present
- 6 USB A socket "Host" e.g. for USB memory stick or external keyboard
- 7-12 For a description of the displays, see the "Operability" section

**USB connection type A (host)**

A USB 2.0 connection is available on a shielded USB A socket at the front of the device. A USB stick, for example, can be connected to this interface as a storage medium. An external keyboard or USB hub may also be connected.

**USB connection type B (function)**

A USB 2.0 connection is available on a shielded USB B socket at the front of the device. This can be used to connect the device for communication with a laptop, for example.



USB-2.0 is compatible with USB-1.1 or USB-3.0, i.e. communication is possible.

**Information on USB devices**

The USB devices are detected by the "plug-and-play" function. If several devices of the same type are connected, only the USB device that was connected first is available. Settings for the USB devices are made in the setup. A maximum of 8 external USB devices (incl. USB hub) can be connected if they do not exceed the maximum load of 500 mA. If overloaded, the corresponding USB devices are automatically disabled.

*Requirements with regard to an external USB hub*

If USB devices are deactivated due to the 500 mA device limit, such devices can be connected by means of a USB hub. Only active USB hubs (i.e. hubs with their own power supply) can be connected to the unit. Hubs with an "overcurrent protection" are recommended. A maximum of 1 hub can be connected to the unit.

*Requirements with regard to the USB stick*

There is no guarantee that all manufacturers' USB sticks will function faultlessly. That is why an industrial grade SD card is recommended to ensure the reliable recording of data. (→ 53)



The USB stick must be formatted to FAT or FAT32. NTFS format is not readable. The system supports only USB sticks with max. 32 GB.

*Requirements with regard to an external USB keyboard*

The system only supports keyboards which can be addressed using generic drivers (HID keyboard - Human Interface Device). Special keys are not supported (e.g. Windows keys). Users can only enter characters that are available in the entry character set of the unit. All unsupported characters are rejected. It is not possible to connect a wireless keyboard. The following keyboard layouts are supported: DE, CH, FR, USA, USA International, UK, IT. See setting under "Setup -> Advanced setup -> System -> Keyboard layout".

**Requirements for the SD card**

Industrial grade SD-HC cards with max. 32 GB are supported.



Use only the industrial grade SD cards described in the "Accessories" section of the Operating Instructions. These have been tested by the manufacturer and guaranteed to function faultlessly in the device. (→ 53)



The SD card must be formatted to FAT or FAT32. NTFS format is not readable.

**6.4 Post-connection check**

Device condition and specifications	Notes
Are cables or the device damaged?	Visual inspection

<b>Electrical connection</b>	<b>Notes</b>
Does the supply voltage match the specifications on the nameplate?	-
Are all terminals firmly engaged in their correct slot?	-
Are the mounted cables strain-relieved?	-
Are the power supply and signal cables correctly connected?	See connection diagram and rear of device.

## 7 Operation options

### 7.1 Overview of operation options

The device can be operated onsite or via interfaces (serial, USB, Ethernet) and operating tools (web server).

### 7.2 Structure and function of the operating menu

#### 7.2.1 Operating menu for operators and maintenance personnel

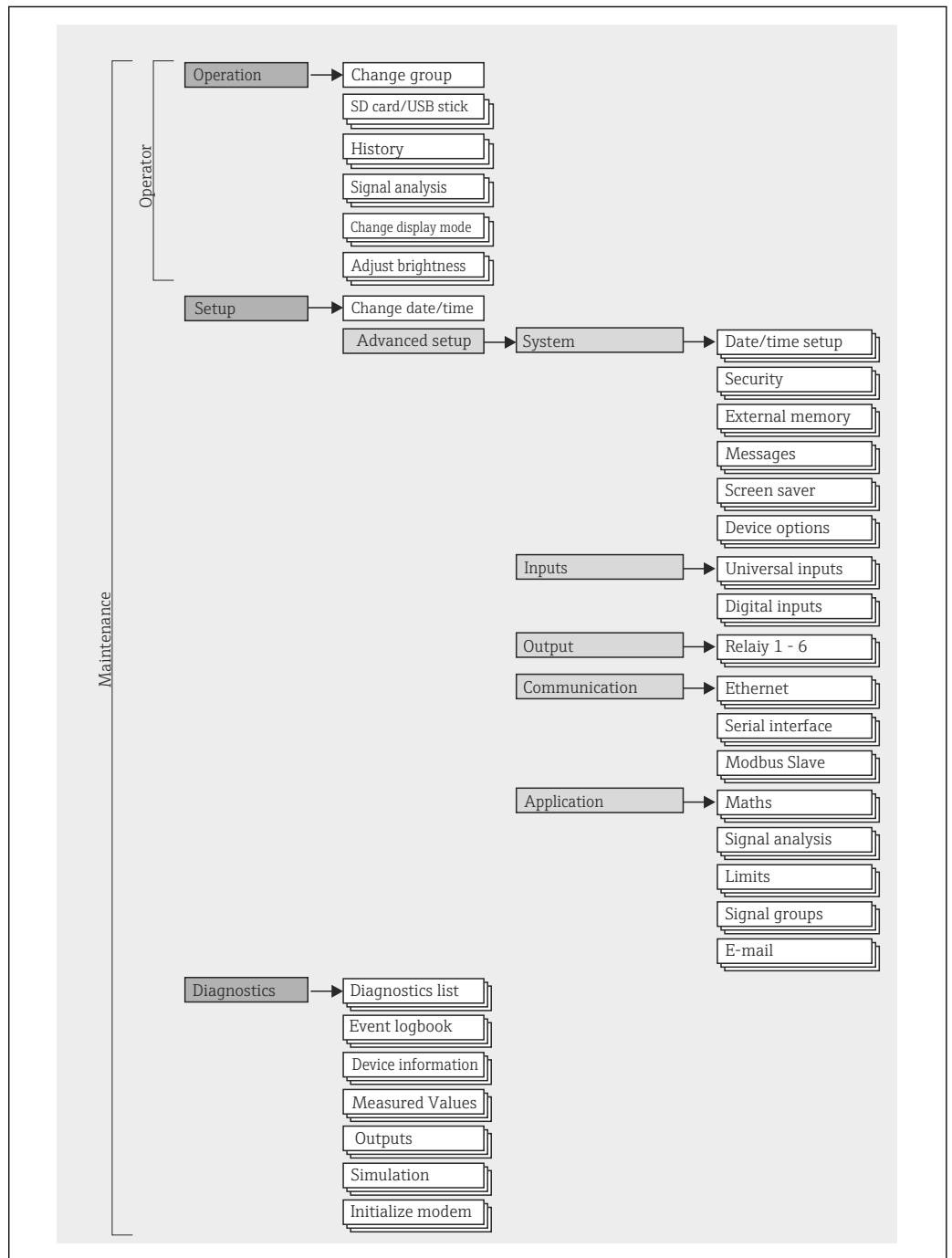

### 7.2.2 Operating menu for experts

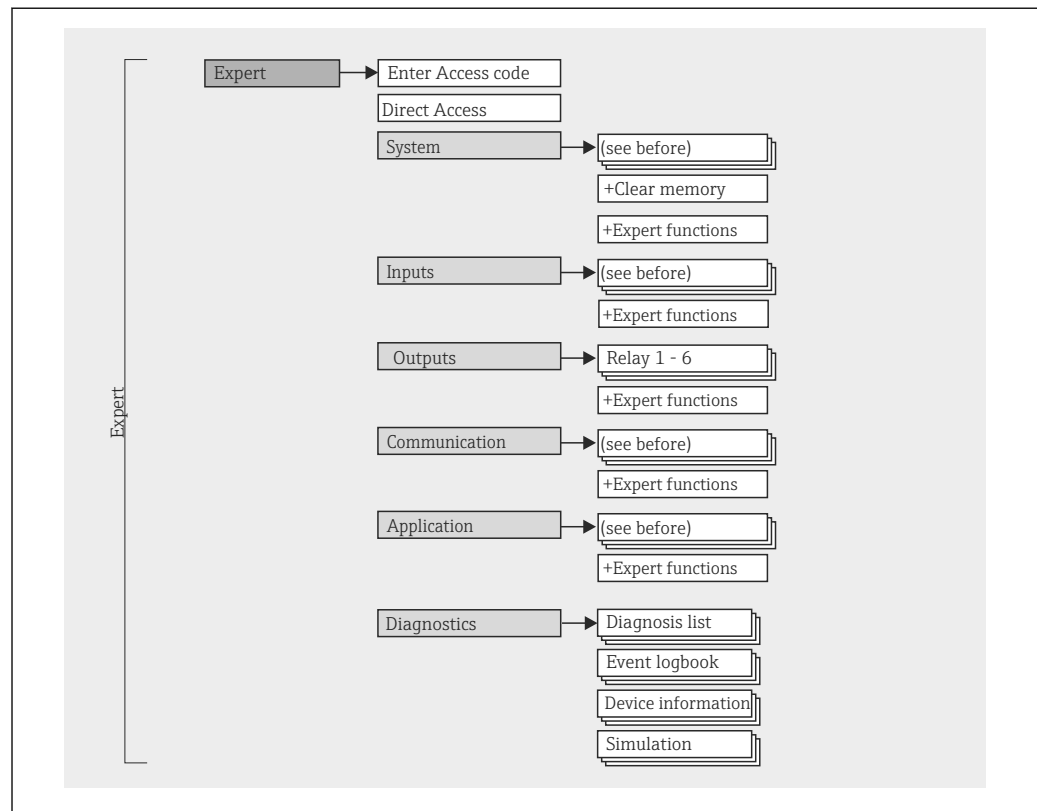

A0019596-EN

### 7.2.3 Submenus and user roles

Certain parts of the menu are assigned to certain user roles. Each user role corresponds to typical tasks within the lifecycle of the device.

User role	Typical tasks	Menu	Content/meaning
Operator	Tasks during operation: <ul style="list-style-type: none"> <li>▪ Configuration of the display.</li> <li>▪ Reading measured values.</li> </ul>	"Operation"	Contains all the parameters that are required in ongoing operation: configuration of the measured value display (displayed values, display format, etc.).
Maintenance	Commissioning: <ul style="list-style-type: none"> <li>▪ Configuration of the measurement.</li> <li>▪ Configuration of data processing (scaling, linearization, etc.).</li> </ul>	"Setup"	Contains all parameters for commissioning: <ul style="list-style-type: none"> <li>▪ <b>Change date/time</b></li> <li>▪ <b>"Extended Setup" submenu</b></li> </ul> Contains additional submenus and parameters: <ul style="list-style-type: none"> <li>- <b>System:</b> Basic settings required for operating the device.</li> <li>- <b>Inputs:</b> Settings for analog and digital inputs.</li> <li>- <b>Outputs:</b> Settings required only if outputs (e.g. relays) are to be used.</li> <li>- <b>Communication:</b> Settings required if you are using the USB, RS232, RS485 or Ethernet interface of the device (PC operation, serial data export, modem operation, etc.).</li> <li>- <b>Application:</b> Define different application-specific settings (e.g. group settings, limit values, etc.).</li> </ul> Once values have been set for these parameters, the measurement should generally be completely configured.

User role	Typical tasks	Menu	Content/meaning
	Fault elimination: <ul style="list-style-type: none"> <li>▪ Diagnosing and eliminating process errors.</li> <li>▪ Interpretation of device error messages and correcting associated errors.</li> </ul>	"Diagnostics"	Contains all parameters for detecting and analyzing errors: <ul style="list-style-type: none"> <li>▪ <b>Diagnosis list</b> All the diagnosis messages pending are output.</li> <li>▪ <b>Event logbook</b> Events such as limit value violations and power failures are listed in chronological order.</li> <li>▪ <b>Device information</b> Display of important device information (e.g. serial number, firmware version, hardware, etc.).</li> <li>▪ <b>Measured values</b> Display of current measured values of device.</li> <li>▪ <b>Outputs</b> Current status of outputs (if used).</li> <li>▪ <b>Simulation</b> Various functions/signals can be simulated for test purposes here. <b>Note:</b> In Simulation mode, normal recording of the measured values is interrupted and the intervention is logged in the event log.</li> <li>▪ <b>Initialize modem</b> Initializes the modem connected to the serial interface (for automatic call answering).</li> </ul>
Expert	Tasks that require detailed knowledge of the function of the device: <ul style="list-style-type: none"> <li>▪ Commissioning measurements under difficult conditions.</li> <li>▪ Optimal adaptation of the measurement to difficult conditions.</li> <li>▪ Detailed configuration of the communication interface.</li> <li>▪ Error diagnostics in difficult cases.</li> </ul>	"Expert"	Contains all parameters of the device (including those that are already in one of the other menus). The expert menu is protected by a code. Factory setting: 0000. This menu is structured according to the function blocks of the device: <ul style="list-style-type: none"> <li>▪ <b>"System" submenu</b> Contains all higher-order device parameters that do not pertain either to measurement or the measured value communication.</li> <li>▪ <b>"Inputs" submenu</b> Contains all parameters for configuring the analog and digital inputs.</li> <li>▪ <b>"Output" submenu</b> Contains all parameters for configuring the outputs (e.g. relays).</li> <li>▪ <b>"Communication" submenu</b> Contains all parameters for configuring the communication interfaces.</li> <li>▪ <b>"Application" submenu</b> Contains all parameters for configuring application-specific settings (e.g. group settings, limit values etc.).</li> <li>▪ <b>"Diagnostics" submenu</b> Contains all parameters for detecting and analyzing errors.</li> </ul>

### 7.3 Measured value display and operating elements

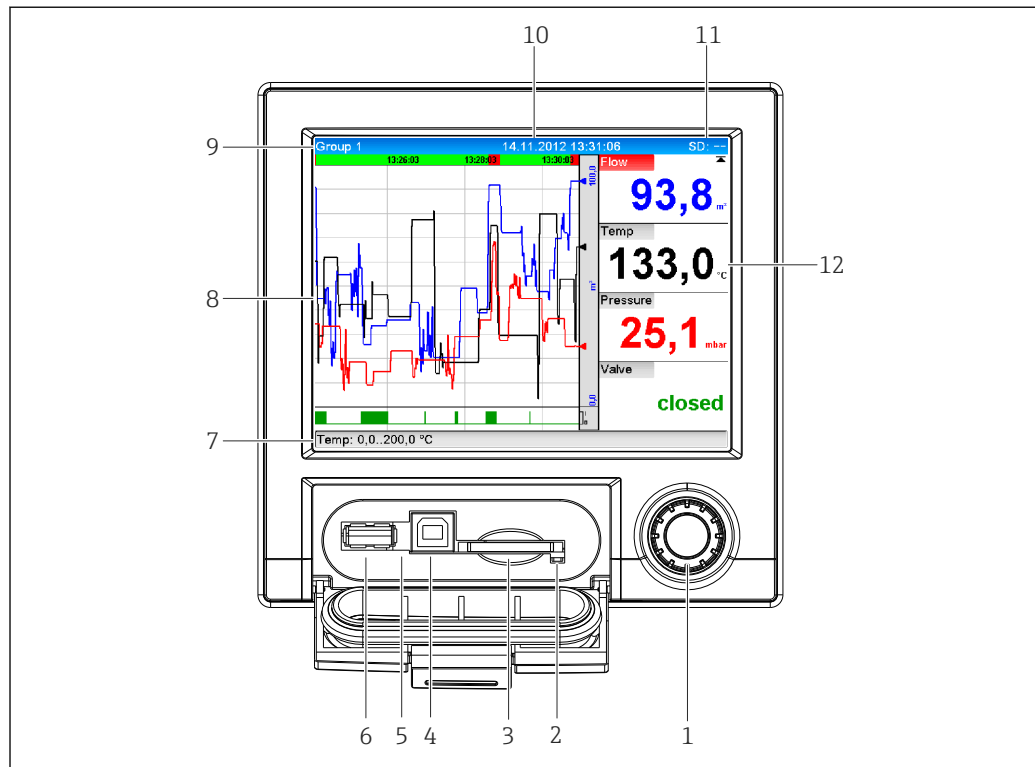





7 Front of device with open flap

Item No.	Operating function (display mode = display of measured values) (Setup mode = operating in the Setup menu)
1	"Navigator": Jog/shuttle dial for operating with additional press function.  In Display mode: turn the dial to switch between the various signal groups. Press the dial to display the main menu.  In Setup mode or in a selection menu: turn the dial anticlockwise to move the bar or the cursor upwards or counterclockwise, changes the parameter. Turning clockwise moves the bar or cursor down or clockwise, changes parameter. Press briefly (<2 sec.) = Select highlighted function, parameter change starts (ENTER key).  Access online help: Press and hold Navigator (>3 sec.) to show information on the selected function. To quit the menu immediately, press and hold "Back" (>3 sec.) in the Navigator. The device switches to Display mode.
2	LED at SD slot. Orange LED lit when the device writes to the SD card or reads it. <b>Do not remove the SD card if the LED is lit! Risk of data loss!</b>
3	Slot for SD card
4	USB B socket "Function" e.g. to connect to PC or laptop
5	Green LED lit: Power supply present
6	USB A socket "Host" e.g. for USB memory stick or external keyboard
7	In Display mode: alternating status display (e.g. set zoom range) of the analog or digital inputs in the appropriate color of the channel.  In Setup mode: different information can be displayed here depending on the display type.
8	In Display mode: window for measured value display (e.g. curve display).  In Setup mode: display of operating menu







Item No.	Operating function (display mode = display of measured values) (Setup mode = operating in the Setup menu)
9	In Display mode: current group name, type of evaluation  In Setup mode: name of the current operating item (dialog title)
10	In Display mode: displays current date/time In Setup mode: --
11	In Display mode: alternating display indicating the percentage space on the SD card or USB stick that has already been used. Status symbols are also displayed in alternation with the memory information (see the following table).  In Setup mode: the current "direct access" operating code is displayed
12	In Display mode: display of current measured values and the status in the event of an error/alarm condition. In the case of counters, the type of counter is displayed as a symbol (see the following table).   If a measuring point has limit value status, the corresponding channel identifier is highlighted in red (quick detection of limit value violations). During a limit value violation and device operation, the acquisition of measured values continues uninterrupted.

### 7.3.1 Display representation of symbols used in operation

Item No.	Function	Description
8,12	<b>Symbols for counters:</b>	
	$\Sigma 0 / \Sigma 1$	Interim analysis/ external analysis
	$\Sigma D$	Daily analysis
	$\Sigma M$	Monthly analysis
	$\Sigma Y$	Annual analysis
	$\Sigma$	Totalizer
8, 12	<b>Channel-related symbols:</b>	
		Violation of lower limit value
		Violation of upper limit value or limit value on counter
		Violation of upper and lower limit values at the same time
	<b>S</b>	<b>"Out of specification"</b> e.g. input signal too high/low
	<b>F</b>	<b>Error message "Failure detected"</b> An operating error has occurred. The measured value is no longer valid (e.g. a channel not displayed in the current group is defective).
	<b>M</b>	<b>"Maintenance required"</b> Maintenance is required. The measured value is still valid.
	<b>-----</b>	<b>Error, measured value not displayed.</b> Possible causes: Sensor / input error, line break, invalid value, input signal too high/low
11	<b>Symbol for status signals:</b>	
		<b>"Device locked"</b> The setup is locked via a control input or access code. Enter the relevant access code or unlock the setup using the control input
	<b>S</b>	<b>"Out of specification"</b> The device is being operated outside its technical specifications (e.g. during warm-up or cleaning processes).
	<b>C</b>	<b>"Function check"</b> The device is in Service mode.

Item No.	Function	Description
	<b>M</b>	<b>"Maintenance required"</b> Maintenance is required. The measured value is still valid.
	<b>F</b>	<b>Error message "Failure detected"</b> An operating error has occurred. The measured value is no longer valid (e.g. a channel not displayed in the current group is defective).
		<b>"External communication"</b> The device is communicating externally (e.g. via Modbus).
	<b>SIM</b>	<b>"Simulation"</b> Simulation is active.

### 7.3.2 Symbols in operating menus



	Symbol for setup
	Symbol for expert setup
	Symbol for diagnostics
	Back Use the "Back" function, which can be found at the bottom of each menu/submenu, to move up a level in the menu structure.
	To quit the menu immediately, press and hold "Back" (>3 sec.) in the Navigator. The devices switches to Display mode.

### 7.3.3 Entering text and numbers (virtual keyboard)

A virtual keyboard is available for entering text and numbers. This is opened automatically if needed. Here, turn the navigator to select the corresponding character and press the navigator to accept it.

The following characters are available for entering free text:

0-9 a-z A-Z = + - \* / \ <sup>23</sup> ¼ ½ ¾ ( ) | | < > { } I ? ! ` " ' ^ % ° . , : \_ μ & # \$ € @ \$ £ ¥ ~

←	Jump one position to the left. If this symbol is selected, the cursor jumps one position to the left.
→	Jump one position to the right. If this symbol is selected, the cursor jumps one position to the right.
← x	Delete backwards. If this symbol is selected, the character to the left of the cursor position is deleted.
x →	Delete forwards. If this symbol is selected, the character to the right of the cursor position is deleted.
	Delete all. if this symbol is selected, the entire entry is deleted.
	Reject entry. If this symbol is selected, the entry is rejected and you quit editing mode. The previously set text remains.
✓	Accept entry. If this symbol is selected, the entry is applied at the position specified by the user, and you quit editing mode.

### 7.3.4 Channel color assignment

Channel color assignment is performed in the main menu under "**Setup -> Advanced setup -> Application -> Signal groups -> Group x**". 8 predefined colors are available per group and can be assigned to the desired channels.

## 7.4 Access to the operating menu via the local display

Using the "Navigator" (jog/shuttle dial with additional press function), all settings can be made directly onsite at the device.

## 7.5 Device access via operating tools

### 7.5.1 Analysis software (SQL database support)

The analysis software offers centralized data administration with visualization for recorded data. The analysis software enables the complete archiving of all measuring point data e.g. measured values, diagnostic events and protocols. The analysis software stores data in a SQL database. The database can be operated locally or in a network (client / server). Access is via RS232/RS485, USB or Ethernet interface (network).



An "Essential" version of the analysis software are included with the device.

- Export of saved data (measured values, analyses, event log)
- Visualization and processing of saved data (measured values, analyses, event log)
- Safe archiving of exported data in a SQL database

For details, see the Operating Instructions on the analysis software CD-ROM provided

### 7.5.2 Web server

A web server is integrated into the device. This makes the current measured values of the device available in real time. Access is via an Ethernet interface from a PC in the network via the standard browser. The installation of additional software is not required.

The web server offers the following range of functions:

- Display of current and historical data and measured value curves via the web browser
- Easy configuration without additional installed software
- Remote access to device and diagnostic information

### 7.5.3 OPC server (optional)

The OPC server makes it possible to access data on the device. These data are made available to OPC clients in real time. The OPC server meets the requirements of the OPC specifications regarding the supply of data to an OPC client. Access is via RS232/RS485, USB or Ethernet interface (network). Communication takes place using automatic device detection; the operator does not need to make any additional settings. The OPC server enables the flexible and powerful exchange of data and is easy and convenient to use.

The following momentary values can be provided:

- Analog channels
- Digital channels
- Mathematics
- Totalizer



## 8 System integration

### 8.1 Integrating the measuring device in the system

#### 8.1.1 General notes

The device has (optional) fieldbus interfaces for exporting process values. Measured values and statuses can also be transmitted to the device via fieldbus. Note: Counters cannot be transferred.

Depending on the bus system, alarms or faults occurring during data transmission are displayed (e.g. status byte).

The process values are transferred in the same devices that are used for display at the device.

#### 8.1.2 Ethernet

**Setup**→**Advanced setup**→**Communication**→**Ethernet**

The IP address can be entered manually (fixed IP address) or assigned automatically using DHCP.

The port for data communication is preset to 8000. The port can be changed In the **Expert**→**Communication**→**Ethernet** menu.

The following functions are implemented:

- Data communication with PC software (analysis software, OPC server)
- Web server

The following connections are possible at the same time:

- 1x Port 8000 (OPC server or analysis software)
- 1x Port 8002 (OPC server only)
- 4x Modbus slave TCP
- 5x Web server



Ports can be changed!

As soon as the maximum number of connections has been reached, new connection attempts are blocked until an existing connection has been terminated.

#### 8.1.3 Modbus RTU/TCP slave

The device can be connected to a Modbus system via RS485 or Ethernet interface. The general settings for the Ethernet connection are made in the **Setup**→**Advanced setup**→**Communication**→**Ethernet** menu. Configuration for Modbus communication is done in the **Setup**→**Advanced setup**→**Communication**→**Modbus slave** menu. Up to 12 analog inputs and 6 digital inputs can be transmitted via Modbus and stored in the device.

Menu position	RTU	Ethernet
Device address:	1 to 247	IP address manual or automatic
Baud rate:	2400/4800/9600/ <b>19200</b> /38400	-
Parity:	Even/Odd/ <b>None</b>	-
Port	-	502

#### Transfer of values

The actual Modbus TCP protocol is located between layer 5 to 6 in the ISO/OSI model.

To transfer a value, 3 registers of 2 bytes each (2-byte status + 4-byte float) or 5 registers of 2 bytes each (2-byte status + 8-byte double) are used.

 Additional information on the Modbus can be found in the documentation on the CD-ROM provided.

## 9 Commissioning

### 9.1 Function check

Make sure that all post-connection checks have been carried out before putting your device into operation:

- Checklist for "post-installation check", (→  11).
- Checklist for "post-connection check" (→  19).

### 9.2 Switching on the measuring device

Once the operating voltage is applied, the display lights up and the device is ready for operation.



If you are commissioning the device for the first time, program the setup as described in the following sections of the Operating Instructions.

If you are commissioning a device that is already configured or preset, the device starts measuring immediately as defined in the settings. The values of the channels currently activated are shown on the display.

-  Remove the protective film from the display as this would otherwise affect the readability of the display.

### 9.3 Setting the operating language

The operating language can be set in the main menu. You can access the main menu by pressing the Navigator during operation. "Sprache/Language" appears in the display. Press the Navigator again to open the language selection. Turn the Navigator to select the desired language, and press the Navigator to apply the language.

-  Use the  "Back" function, which can be found at the bottom of each menu/submenu, to move up a level in the menu structure.

To quit the menu immediately, press and hold "Back" (>3 sec.) in the Navigator. You will return immediately to the measured value display.

### 9.4 Configuring the measuring device (Setup menu)

Access to the setup is released when the device leaves the factory and can be locked in various ways e.g. by entering a 4-digit access code. When locked, basic settings can be checked but not changed. You can also use a PC to commission or configure your device.

Device configuration options

- Setup directly at the device
- Setup via SD card or USB stick by transferring the parameters stored on it
- Setup via web server using Ethernet

#### 9.4.1 Setup directly at the device

You can access the main menu by pressing the Navigator during operation. Turn the Navigator to navigate through the available menus. When the desired menu is displayed, press the Navigator to open the menu.

In the "Setup" menu and in the "Advanced setup" submenu, you will find the **most important** settings for the device:

Parameter		Possible settings	Description
Change date/time		UTC time zone dd.mm.yyyy hh:mm:ss	You can change the date and time here.
Advanced setup			Advanced settings for the device e.g. system settings, inputs, outputs, communication, application etc.
	System		Basic settings that are needed to operate the device, (e.g. date/ time, security, memory management, messages, etc.)
	Inputs		Settings for analog and digital inputs.
	Outputs		Settings only required if outputs (e.g. relays or analog outputs) are to be used.
	Communication		Settings required if the USB, RS232/RS485 or Ethernet interface of the device is to be used (PC operation, serial data export, modem operation, etc.).  The different interfaces (USB, RS232/RS485, Ethernet) can be operated in parallel. However, simultaneous use of the RS232 and RS485 interface is not possible.
	Application		Define different application-specific settings (e.g. group settings, limit values etc.).

 A detailed overview of all operating parameters can be found in the appendix at the end of the Operating Instructions. (→  67)

### 9.4.2 Setup via SD card or USB stick

Save the device settings (setup data) on an SD card or USB stick. This setup file can then be imported into other devices.

**Save setup:** The function used to save the setup files can be found in the main menu under "Operation -> SD card (or USB stick) -> Save setup".

#### CAUTION

**If the SD card or USB stick are removed directly:**

Risk of data loss on SD card or USB stick

- ▶ To remove the SD card or the USB stick, always select "Operation -> SD card (or USB stick) -> Remove safely" in the main menu!

**Import new setup directly at the device:** The function used to load the setup data can be found in the main menu under "Operation -> SD card (or USB stick) -> Load setup". Repeat these steps to configure additional units with this setup.

#### CAUTION

**If the SD card is not removed, saving of the measurement data will commence after approx. 5 minutes.**

Measured values may be saved unintentionally on the SD card. However, the setup data are still retained in the memory.

- ▶ Replace SD card on time!

### 9.4.3 Setup via web server

To configure the device via the web server, connect the device via Ethernet to your PC.

Please observe the information and communication settings for Ethernet and the web server under (→  29)



 To configure the device via a web server, you must have Administrator or Service access. Prior to accessing the web server, create an ID and password in the main menu under "Setup -> Advanced setup -> Communication -> Ethernet -> Configuration Web server -> Authentication".

ID default value: admin; Password: admin

Note: The password should be changed during commissioning!

#### Establishing a connecting and setup

Procedure for setting up a connection:

1. Connect the device to the PC via Ethernet
2. Start the browser at the PC; open the web server for the device by entering the IP address: http://<ip-adresse> Note: Leading zeros in IP addresses must not be entered (e.g. enter 192.168.1.11 instead of 192.168.001.011).
3. Enter ID and password, and confirm each by clicking "OK"
4. The web server shows the momentary value display of the device. Click "Menu" in the web server taskbar.
5. Starting configuration

Continue with device configuration in accordance with the Operating Instructions for the device. The complete Setup menu i.e. all of the parameters listed in the Operating Instructions, can also be found on the web server. Once configuration is complete, log out of the web server.

#### NOTICE

Undefined switching of outputs and relays

During configuration using a web server, the device may assume undefined statuses! This may result in the undefined switching of outputs and relays.

 Procedure to establish a direct connection via Ethernet (point to point connection):  
(Seite 36)

## 9.5 Advanced settings (Expert menu)

You can access the main menu by pressing the Navigator during operation. Turn the Navigator to navigate to the "Expert" menu. Press the Navigator to open the menu.

**i** The Expert menu is protected by the code "0000". If an access code is set up under "Setup -> Advanced setup -> System -> Security -> Protected by -> Access code", this must be entered here.

You will find **all** settings for the device in the "Expert" menu:

Parameter	Possible settings	Description
Direct access	000000-000	Direct access to parameters (fast access)
System		Basic settings that are needed to operate the unit, (e.g. date/ time, security, memory management, messages, etc.)
Inputs		Configuration of analog and digital inputs.
Outputs		Settings only required if outputs (e.g. relays or analog outputs) are to be used.
Communication		Settings required if the USB, RS232/RS485 or Ethernet interface of the device is to be used (PC operation, serial data export, modem operation, etc.). <b>i</b> The different interfaces (USB, RS232/RS485, Ethernet) can be operated in parallel. However, simultaneous use of the RS232 and RS485 interface is not possible.
Application		Define different application-specific settings (e.g. group settings, limit values etc.).
Diagnostics		Device information and service functions for a swift device check.

**i** A detailed overview of all operating parameters can be found in the appendix at the end of the Operating Instructions. (→ 67)

## 9.6 Configuration management

**i** You can save the setup data ("Configuration") to an SD card or a USB stick. This allows additional devices to be configured very easily using the same settings.

**Save setup:** The function used to save the setup files can be found in the main menu under "Operation -> SD card (or USB stick) -> Save setup".

### **CAUTION**

**If the SD card or USB stick are removed directly:**

Risk of data loss on SD card or USB stick

- ▶ To remove the SD card or the USB stick, always select "Operation -> SD card (or USB stick) -> Remove safely" in the main menu!

## 9.7 Simulation

Various functions/signals can be simulated for test purposes here.

### **NOTICE**

**Selecting Simulation: Simulation of the relays can be found in the main menu under "Diagnostics -> Simulation". Simulation of the measured values can be found in the main menu under "Expert -> Diagnostics -> Simulation".**

In the Simulation mode only simulated values will be recorded and the intervention is logged in the event log.

- ▶ Do not start simulation if measured value recording must not be interrupted!

## 9.8 Protecting settings from unauthorized access

To protect the setup from unauthorized access, the setup must be protected by means of an access code or control input once configuration is complete. In order to change any parameter, the correct code must first be entered or the device must be unlocked using the control input.

**Setup lock via control input:** The settings for the control input can be found in the main menu under "**Setup -> Advanced setup -> Inputs -> Digital inputs -> Digital input X -> Function: Control input; Action: Lock setup**".



It is preferable to lock the setup using a control input.

**Setting up an access code:** The settings for the access code can be found in the main menu under "**Setup -> Advanced setup -> System -> Security -> Protected by -> Access code**". Factory setting: "open access", i.e. can be changed at any time.



Make a note of the code and store in a safe place. Videographic recorder

## 10 Operation

The "Operation" menu is geared towards the tasks and activities of the operator. It contains all the parameters that are needed in ongoing operation. Historical values and analyses, for example, can be displayed in the "Operation" menu and display settings can be made. Any settings made for the onsite display have no effect on the measurement section or the configured device parameters.

The unit's simple control system and the integrated help function enables you to perform operation for many applications without the need for hardcopy operating instructions.

### 10.1 Displaying and modifying current Ethernet settings

To establish communication with the device via Ethernet, the following settings must be known or modified where necessary:

**Display IP/MAC address** (only if DHCP is enabled): The device's IP or MAC address can be found in the main menu under "**Diagnostics -> Device information -> Ethernet**".

**Display/change Ethernet settings:** The device's Ethernet settings can be found in the main menu under "**Setup -> Advanced setup -> Communication -> Ethernet**".

**Procedure to establish a direct connection via Ethernet (point to point connection):**

1. Configure the PC (depends on operating system): e.g. IP address: 192.168.1.1; subnet mask: 255.255.255.0; gateway: 192.168.1.1
2. Disable DHCP on the device
3. Make communication settings on the device: e.g. IP address: 192.168.1.2; subnet mask: 255.255.255.0; gateway: 192.168.1.1



A crossover cable is not required.

### 10.2 Reading device locking status

If setup is locked via a control input, a padlock symbol  appears on the top right of the screen. The setup must first be unlocked via the control input before device parameters can be edited.

**Setup lock via control input:** The settings for the control input can be found in the main menu under "**Setup -> Advanced setup -> Inputs -> Digital inputs -> Digital input X -> Function: Control input; Action: Lock setup**".

If setup is locked via the access code, all the operating parameters can be displayed, and can also be edited as soon as the access code is entered.

## 10.3 Reading measured values

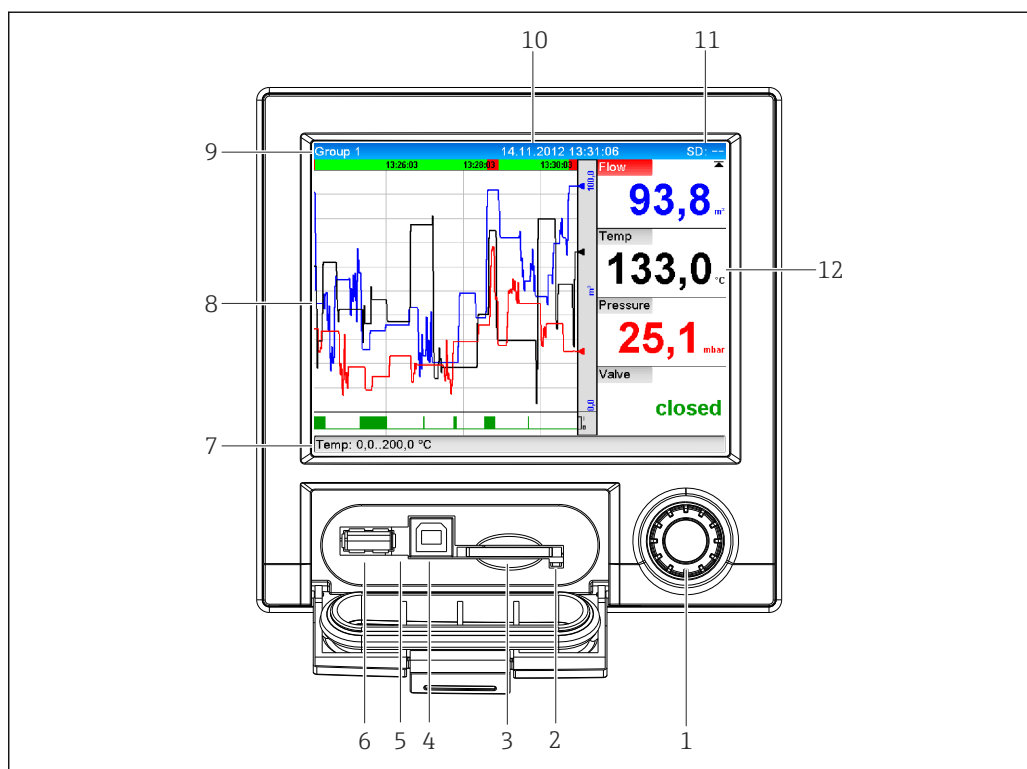

A0020602-EN

### 8 Front of device with open flap

- 1 Navigator: press briefly to open the main menu and confirm messages (=Enter); press for longer to open the online help
- 2 Orange LED for read/write access to the SD card
- 3 Slot for SD card
- 4 USB-B socket "Function"
- 5 Green LED lit: power supply present
- 6 USB-A socket "Host"
- 7 Status bar
- 8 Area for measured value display (e.g. curve display)
- 9 Header: group name, analysis type
- 10 Header: current date / time
- 11 Header: alternating display indicating the percentage space on the SD card or USB stick that has already been used. Status symbols are also displayed in alternation with the memory information.
- 12 Display of current measured values and the status in the event of an error/alarm condition. In the case of counters, the type of counter is displayed as a symbol.

**i** An overview of all the symbols and icons is provided in the operating options section. (→ 25)

**i** If a measuring point has limit value status, the corresponding channel identifier is highlighted in red (quick detection of limit value violations). During a limit value violation and device operation, the acquisition of measured values continues uninterrupted.

**i** Information on how to rectify a problem should an error occur is provided in the "Troubleshooting" section. (→ 42)

## 10.4 Reading measured values via the web server

A web server is integrated into the device. If the device is connected via Ethernet, it is possible to display the measured values via the internet using a web server.

Activation of web server in the menu **Setup**→**Advanced setup**→**Communication**→**Ethernet**→**Web server**→**Yes** or the menu **Expert**→**Communication**→**Ethernet**→**Web server**→**Yes**

The web server port is preset to 80. The port can be changed in the **Expert**→**Communication**→**Ethernet** menu.

 If the network is protected by a firewall, the port may need to be activated.

The following web browsers are supported:

- MS Internet Explorer 8 and higher (in order to utilize the full functionality of the web server using the latest version of Internet Explorer is recommended)
- Mozilla Firefox 15 and higher
- Opera 12.x and higher
- Google Chrome 23.x and higher

 To configure the device via a web server, you must have Administrator or Service access. Prior to accessing the web server, create an ID and password in the main menu under "**Setup** -> **Advanced setup** -> **Communication** -> **Ethernet** -> **Configuration Web server** -> **Authentication**".

ID default value: admin; Password: admin

Note: The password should be changed during commissioning!

Data can be exported via the web server in HTML or XML format.

#### 10.4.1 Access to the web server via HTTP (HTML)

When using an internet browser, you just need to enter the address **http://<ip-address>** to have the HTML view displayed in the browser.

 Note: Leading zeros in IP addresses must not be entered (e.g. enter 192.168.1.11 instead of 192.168.001.011).

As in the case of the display, you can alternate between the display groups in the web server. The measured values are updated automatically (directly via "link": off/5s/15s/30s/60s). In addition to the measured values, status and limit value flags are displayed.

#### 10.4.2 Access to the web server via XML

XML format is available in addition to HTML format and contains all measured values of a group. This can be integrated into additional systems as the user wishes.

The XML file is available in ISO-8859-1 (Latin-1) coding at **http://<ip-address>/values.xml** (alternative: **http://<ip-address>/xml**). However, some special characters, such as the Euro symbol, cannot be displayed in this file. Texts such as digital statuses are not transmitted.

 Note: Leading zeros in IP addresses must not be entered (e.g. enter 192.168.1.11 instead of 192.168.001.011).

 The decimal point is always displayed as a period in the XML file. Also, all times are given in UTC The time difference in minutes is noted in the following entry.

The structure of the channel values for the XML file is explained as follows:

```
<device      id="AI01IV" tag="Channel 1" type="INTRN">
  <v1>50.0</v1>
  <u1>%</u1>
  <vtime>20130506-140903</vtime>
  <vstslvl1>0</vstslvl1>
  <hlsts1>L</hlsts1>
  <param><min>0.0</min><max>100.0</max><hh></hh><hi></hi><lo></lo><ll></ll></
  param>
  <tag>Channel 1</tag>
  <man>Manufacturer</man>
</device>
```

Day	Description
device id	Unique ID of measuring point
tag	Channel ident.
type	Data type (INTRN, MODBUS)
v1	Measured value of channel as a decimal value
u1	Unit of measured value
vtime	Date and time
vstslvl1	Error level 0 = OK, 1 = warning, 2 = error
hlsts1	Limit value status H = upper limit value, L = lower limit value, LH = upper and lower limit value violation
param min max hh hi lo ll	Parameter (optional) Lower zoom Upper zoom Upper alarm limit Upper warning limit Lower warning limit Lower alarm limit
MAN	Manufacturer

## 10.5 Data analysis and visualization using analysis software provided

The analysis software offers centralized data administration with visualization for recorded data.

This allows the complete data of a measuring point to be archived, e.g.:

- Measured values
- Diagnostic events
- Protocols

The analysis software stores data in a SQL database. The database can be operated locally or in a network (client / server). You can install and use the free PostgreSQL™ database available on the CD-ROM.

For details, see the Operating Instructions on the analysis software CD-ROM provided

## 10.6 Changing the group

**Change group:** The group to be displayed can be changed in the main menu under "Operation -> Change group".

 Only the **active** groups are displayed here. The settings for this can be made in the main menu under "**Setup -> Advanced setup -> Application -> Signal groups -> Group x**".

## 10.7 SD card / USB stick

You can find functions to save measured data and device settings on a removable medium in the main menu under "**Operation -> SD card / USB stick**" (only if an SD card or USB stick is provided).

### Remove safely:

All internal access is terminated to ensure safe removal of the storage medium from the device. You are notified when it is safe to remove the data storage medium. 5 minutes after the message, the device automatically saves data on the storage medium again.

 Only remove the data storage medium using this function; otherwise data may be lost!

### Update:

Measurement data not yet saved on the storage medium are now saved. Please be patient! Measured value acquisition is running in parallel and has top priority.

 Data from several devices can be saved onto one storage medium.

#### ▪ Save measured values:

A user-definable time range can be saved on the data storage medium.

#### ▪ Load setup:

Loads device settings (setup) from the storage medium onto the device.

#### ▪ Save setup:

All device settings (setup) are saved onto the storage medium. They can be archived or used for other devices.

#### ▪ Screenshot:

Save the current measured value display as a bitmap on the SD card or USB stick.

#### ▪ Update firmware:

Loads new firmware onto the device. Only visible if a firmware file is provided on the SD card or USB stick.

 Caution: The device will restart. Save the setup and measured values beforehand on the SD card or USB stick.

## 10.8 Showing data logging

You can scroll through the saved measured values in the main menu under "**Operation -> History**". Turn the navigator clockwise or counterclockwise to scroll back and forth between the measured value curves. Press the navigator to make other settings for the historical data display (e.g. scroll speed, zoom factor or change display mode) or quit the historical data function.

 The gray header on the screen indicates that historical values are being displayed (this header is blue during instantaneous value display).

## 10.9 Signal analysis

The analyses saved in the device are displayed in the main menu under "**Operation -> Signal analysis**".



- **Actual intermediate analysis:**  
Here, you can have the current (i.e. not yet completed) intermediate analysis displayed.
- **Actual day:**  
Here, you can have the current (i.e. not yet completed) daily analysis displayed.
- **Actual month:**  
Here, you can have the current (i.e. not yet completed) monthly analysis displayed.
- **Actual year:**  
Here, you can have the current (i.e. not yet completed) annual analysis displayed.
- **Search:**  
Search and display of analyses. Select which analyses should be searched for/displayed: Intermediate analysis, Daily analysis, Monthly analysis, Annual analysis.

## 10.10 Changing the display mode

The display mode of the active group can be changed in the main menu under "**Operation -> Change display mode**".

**Change display mode:** The following display modes are possible: Curve, Curve in ranges, Waterfall, Waterfall in ranges, Bargraph and Digital display.

 The various display modes have no influence on the signal recording.

## 10.11 Adjusting the brightness of the display

You can adjust the brightness of the display in the main menu under "**Operation -> Adjust brightness**":

Parameter	Possible settings	Description
Adjust brightness	0-255 Default: <b>80</b>	Sets the brightness of the display

# 11 Diagnostics and troubleshooting

To help you troubleshoot, the following section is designed to provide an overview of possible causes of errors and initial remedial measures.

## 11.1 General troubleshooting



**Danger! Electric voltage!**

► Do not operate the device in an open condition for error diagnosis!

Display	Cause	Remedy
No measured value display; no LED lit	No supply voltage connected	Check the supply voltage of the device.
	Supply voltage is applied; device or power unit is defective	The power unit or the device must be replaced.
Diagnostic message is displayed	The list of diagnostic messages is provided in the following section.	

**i Dead pixels:** Dead pixels refer to pixels on LCD and TFT displays that are defect due to the technology or manufacturing techniques used. The TFT display used can have up to 10 dead pixels (Class III as per ISO 13406-2). These dead pixels do not entitle the user to a warranty claim.

## 11.2 Troubleshooting

The Diagnostics menu is used for the analysis of the device functions and offers comprehensive assistance during troubleshooting. Always proceed as follows to locate the cause of the device errors or alarms.

### General troubleshooting procedure

1. Open diagnosis list: lists the 30 most recent diagnostic messages. This can be used to determine which errors are currently present and whether an error has repeatedly occurred.
2. Diagnosis of current measured values: Verify the input signals by displaying the current measured values or the scaled measuring ranges. To verify calculations, call up calculated auxiliary variables if necessary.
3. Most errors can be rectified by performing steps 1 and 2. If the error persists follow the troubleshooting instructions in the following sections.
4. If this does not rectify the problem, contact the Service Department. Any time you contact the Service Department please always have the error number and the information in the main menu under **"Diagnostics -> Device information"** (program name, serial number etc.) to hand.

### 11.2.1 Device error/alarm relay

One relay can be used as an alarm relay. If the device detects a system error (e.g. hardware defect) or a malfunction (e.g. cable open circuit), the selected output/relay switches. The alarm relay is assigned in the main menu under **"Setup -> Advanced setup -> System -> Fault switching -> Relay x"**. **Factory setting: Relay 1.**

This "alarm relay" switches if "F"-type or "S"-type errors occur, i.e. "M"-type or "C"-type errors do not switch the alarm relay.

### 11.2.2 Troubleshooting for Modbus RTU

- Do the device and master have the same baudrate and parity?
- Is the interface correctly wired?
- Does the device address sent by the master match the configured address of the device?
- Do all the slaves on the Modbus have different device addresses?

### 11.2.3 Troubleshooting for Modbus TCP

- Is the Ethernet connection between the device and master correct?
- Does the IP address sent by the master match the address configured on the device?
- Does the port configured on the master match the port configured on the device?

## 11.3 Diagnostic information on the local display

The diagnostic message consists of a diagnostic code and a message text.

The diagnostic code is made up of the error category as per Namur NE 107 and the message number.

Error category (letter in front of the message number)

- **F = Failure.** A malfunction has been detected.  
The measured value of the affected channel is no longer reliable. The cause of the malfunction is to be found in the measuring point. Any controller connected should be set to manual mode. An alarm relay can be assigned to this error category in the Advanced setup.
- **M = Maintenance required.** Action must be taken as soon as possible.  
The device still measures correctly. Immediate measures are not necessary. However, proper maintenance efforts would prevent a possible malfunction in the future.
- **S = Out of specification.** The measuring point is being operated outside specifications. Operation is still possible. However, you run the risk of increased wear, shorter operating life or lower accuracy levels. The cause of the problem is to be found outside the measuring point.
- **C = Function check.** The device is in Service mode.

Diagnostic code	Message text	Description	Remedy
F100	Sensor-/Input error!	Sensor/input error	Check the connections and parameters
F101	Open circuit!	Open circuit	Check connections
F105	Invalid value!	Measured value is invalid (when calculating --> NAN)	Check process variables
F201	Device fault	Device error	Contact the Service Department
F261	Failure: RAM	No access to RAM	Contact the Service Department
F261	Error: Flash	No access to flash	Contact the Service Department
F261	Error: SRAM	No access to SRAM	Contact the Service Department
F261	Analog card x is out of order!	Hardware defect detected	Contact the Service Department, replace card
F261	Digital card out of order!	Hardware defect detected	Contact the Service Department, replace card
F261	Fieldbus card out of order!	Hardware defect detected	Check contacts of Anybus card, contact the Service Department
F261	Power supply out of order!	Hardware defect detected	Contact the Service Department, replace power unit
M284	Firmware update	Firmware has been updated.	No action required. Message can be acknowledged.

Diagnostic code	Message text	Description	Remedy
F301	Error: Cannot load setup	Setup defective	Switch the device off and then on again, re-configure, contact the Service Department if necessary
M302	Setup restored from backup	Setup has been loaded from backup.	Check setup
F303	Error: Device data	Device data defective	Contact the Service Department
M304	Backup: Device data	Device data defective. However it was possible to continue working with the backup data.	Check settings (e.g. serial number)
F307	Error: Customer preset value defective	Customer preset value defective	
F309	Error: Date/time is not set	Invalid date/time (e.g. internal battery is empty)	Device was switched off too long. The date/time must be set again. Battery might need to be replaced (contact the Service Department).
F310	Error: Cannot save setup	The setup could not be saved.	Contact the Service Department
F311	Error: Device data	The device data could not be saved.	Contact the Service Department
F312	Error: Calibration data defective	The calibration data could not be saved.	Contact the Service Department
F312	Analog card x is not calibrated!	Analog card x is not calibrated! The device works with default values, i.e. the measured values could be inaccurate under certain circumstances.	Contact the Service Department
M313	SRAM has been defragmented	SRAM was defragmented after firmware update	No action required. Message can be acknowledged.
F314	Error: Option code	Activation code is no longer correct (incorrect serial number/program name). Option has been switched off and setup preset has been performed.	Enter new code
M315	No IP address could be obtained from the DHCP server!	No IP address could be obtained from the DHCP server!	Check the network cable
M316	Invalid MAC address!	No or incorrect MAC address	Contact the Service Department
M317	Battery voltage < 2 V. Please replace battery!		Battery needs to be replaced (contact the Service Department)
F348	Firmware cannot be updated: <ul style="list-style-type: none"> <li>■ Checksum incorrect</li> <li>■ Firmware incompatible!</li> </ul>	Firmware update has been aborted because the firmware file is damaged or is not compatible with this device	Contact the Service Department
M350	Measured value acquisition interrupted for calibration/service work. Measured value acquisition restarted.	Measured value acquisition was interrupted/reactivated for service/maintenance purposes. Causes include: <ul style="list-style-type: none"> <li>■ Calibration of inputs/outputs</li> <li>■ Firmware update</li> </ul>	No action required. Message can be acknowledged.

Diagnostic code	Message text	Description	Remedy
M351	The device is restarted.	The device is rebooting. Causes include: <ul style="list-style-type: none"> <li>Following a firmware update</li> <li>Change to device options</li> </ul>	No action required. Message can be acknowledged.
F431	Error:Calibration	Calibration data missing	Contact the Service Department
M502	Device is locked!	Device is locked! The message appears when an attempt is made to update the firmware, for example.	Check lock per digital channel
F510	Setup was corrected.	The device has discovered that the configuration is no longer correct. All the parameters affected have been reset to the factory default settings. Possible causes: <ul style="list-style-type: none"> <li>Input cards have been removed or replaced by another type</li> <li>An input card is no longer working correctly</li> </ul> A firmware update has caused compatibility problems. Note: This error message appears each time the device is restarted until at least one change has been made to the configuration.	Please check the configuration of the device. If hardware has been replaced, no other action is needed (recommendation: change the operating language so that the error message no longer appears after the next restart).
M520	SMTP: Name could not be resolved (DNS)! SNTP: Name could not be resolved (DNS)!	Problem with name resolution (DNS). SMTP: e-mail SNTP: time synchronization	Check the corresponding settings
M528	Setup is not compatible with this firmware!	An attempt was made to load a setup which is not compatible with this firmware (e.g. another device type)	Check whether the correct file has been selected.
M530	Cannot copy setup.	An error occurred when a setup was loaded from an SD card or USB stick  An error occurred when a setup was saved to an SD card or USB stick	Replace the SD card or USB stick Setup file defective?
S901	Input signal too small	Input signal too small	Check the connections and parameters. Check connected sensor/transmitter.
S902	Input signal too high!	Input signal too high.	Check the connections and parameters. Check connected sensor/transmitter.
M905	Set point x	Set point x has been violated	Note: Error number only occurs if e-mails are sent
M906	End limit value x	Set point x no longer violated	Note: Error number only occurs if e-mails are sent
F910	This software is not enabled for this device.	The current firmware is not enabled for this hardware	Contact the Service Department
M920	Too many messages that need to be acknowledged!	There are too many messages that need to be acknowledged. Another message could not be added.	Acknowledge messages
M921	SD card x% full.	External memory is full	Replace SD card

Diagnostic code	Message text	Description	Remedy
M922	No cyclic value readout	The instantaneous values were not read out for a set time	
M922	No cyclic transfer	The device was not read out via fieldbus for a configurable time	Check the communication of the fieldbus. Check PLC.
M924	Error accessing SD card! Error accessing USB stick! SD card is not or wrong formatted! USB stick is not or wrong formatted!	Impossible to access the removable data medium. Causes include: Memory is larger than 32 GB Invalid format (only FAT or FAT32 are permitted)	Check/replace removable data medium
M925	SD card is write-protected!	SD card is write-protected!	Remove write protection
M927	Insufficient space free on data storage medium!	At attempt was made to save to the SD card or USB stick (setup, screenshot, etc.), but not enough free memory space is available.	Use other SD card / USB stick. Delete files that are no longer needed from the SD card / USB stick
F929	File is damaged!	The file that should be loaded is damaged/invalid (e.g. wrong checksum).  This message can occur in connection with the following actions, for instance: Loading setup from SD card / USB stick  Firmware update  Loading process-related graphics	Create file again, use other storage medium.
M940	E-mail could not be sent!		Check settings / network connection
M941	No connection to the e-mail server!		Check settings / network connection
M942	SMTP: error occurred (x).	An error occurred when sending an e-mail. x= error code: 0: SMTP was switched off when the mail was being sent 3: TCP/IP connection was denied 4: TCP/IP connection error 5: SMTP server denied 6: Error during authentication 7: Connection unexpectedly lost 8: Server responded with error code 9: Timeout 10: Internal protocol error	Check settings / network connection
M944	SMTP: authentication failed!		Check settings / network connection
M945	SNTP: Time was not synchronized!	Time could not be synchronized via SNTP.  Possible reasons: <ul style="list-style-type: none"> <li>■ SNTP server temporarily unavailable</li> <li>■ Settings not correct</li> </ul>	<ul style="list-style-type: none"> <li>■ Check the settings</li> <li>■ Check whether the error occurs often. If it does, choose another time server.</li> </ul>
M945	SNTP server 1 not responding. Try server 2.	Time could not be synchronized via SNTP.  Possible reasons: <ul style="list-style-type: none"> <li>■ SNTP server temporarily unavailable</li> <li>■ Settings not correct</li> </ul>	<ul style="list-style-type: none"> <li>■ Check the settings</li> <li>■ Check whether the error occurs often. If it does, choose another time server.</li> </ul>

Diagnostic code	Message text	Description	Remedy
M946	Screenshot could not be saved (x)!	Screenshot could not be created. Possible causes (x): 0: Error when writing 1: Insufficient free space 2: Bitmap could not be created 3: SD card/USB stick not available or ready	Check/replace the SD card or USB stick
M947	Modem could not be initialized! Please check the cable and modem.	The connected modem could not be initialized by the device.	Please check the cable and modem.

## 11.4 Pending, current diagnostic messages

The diagnostic message that is currently pending, the last diagnostic message and the last device restart are displayed in the main menu under "**Diagnostics -> Current diagnostics**", "**Diagnostics -> Last diagnostics**" or under "**Diagnostics -> Last restart**".

## 11.5 Diagnosis list

The last 30 diagnostic messages are displayed in the main menu under "**Diagnostics -> Diagnosis list**" (messages with Fxxx, Sxxx or Mxxx-type error numbers).

The diagnosis list is designed as a ring memory, i.e. when the memory is full the oldest messages are automatically overwritten (no message).

The following information is saved:

- Error number
- Error text
- Date/time

## 11.6 Event logbook

Events such as limit value violations and power failures are displayed in chronological order in the event logbook. It can be found in the main menu under "**Diagnostics -> Event logbook**". Individual events can be selected and details on the events can be displayed by pressing the navigator.

## 11.7 Device information

Important device information such as the serial number, firmware version, device name and device options are displayed in the main menu under "**Diagnostics -> Device information**".

## 11.8 Diagnostics of measured values

Displays the current measured values in the main menu under "**Diagnostics -> Measured values**". The input signals can be verified here by displaying the scaled and calculated values. To verify calculations, call up calculated auxiliary variables if necessary.

## 11.9 Diagnostics of outputs/relays

Displays the current states of the outputs (relays 1-6) in the main menu under "**Diagnostics -> Outputs**".

## 11.10 Simulation

Various functions/signals can be simulated for test purposes here.

### NOTICE

**Selecting simulation: Simulation of the relays can be found in the main menu under "Diagnostics -> Simulation". The simulation of the measured values can be found in the main menu under "Expert -> Diagnostics -> Simulation".**

Only the simulated values are recorded during simulation. The simulation is recorded in the event logbook.

- ▶ Do not start simulation if measured value recording must not be interrupted!

### 11.10.1 Test time synchronization / SNTP

Time synchronization (SNTP setting) can be tested in the main menu under "**Diagnostics -> Simulation -> SNTP**".

 SNTP must be enabled beforehand in the main menu under "**Setup -> Advanced setup -> System -> Date/time set-up -> SNTP**".

Note: The test can take some time. A message is provided on the device once the test has finished.

### 11.10.2 E-mail test

A test mail can be sent to the selected recipient in the main menu under "**Diagnostics -> Simulation -> E-mail**".

 At least one e-mail address must be set beforehand. A message is provided on the device to confirm if the email was sent or not.

### 11.10.3 Relay test

The relay selected under "**Diagnostics -> Simulation -> Relay x**" can be switched manually in the main menu.

## 11.11 Initializing the modem

Initializes the modem connected (to automatically answer calls). The modem must support the complete AT command syntax.

-  ▪ Set the baudrate in the main menu under "**Setup -> Advanced setup -> Communication -> Serial interface**" and select "**RS232**" as the interface type.
- Connect the modem to the RS232 interface of the device. For this purpose only use the modem cable, which is available as an accessory.

 A GSM modem can only be initialized if a SIM card is inserted and the PIN is entered or the prompt to enter the PIN has been disabled.

## 11.12 Resetting the measuring device

The device can be reset to the as-delivered state with a PRESET. This function should only be performed by a service technician.

The function can be found in the main menu under "**Expert -> System -> PRESET**".

 PRESET is only visible under "Expert" once the service code has been entered.

### Procedure for resetting the measuring device

The PRESET returns all parameters to the factory default setup! The internal memory content is deleted!



- ▶ Save the setup and measured values on the USB stick or SD card. Then perform a PRESET.
  - ↳ The device is reset to the factory default settings.

### 11.13 Firmware history

Overview of unit software history:

Unit software version / date	Software modification	Analysis software version	Version of OPC server	Operating Instructions
V01.00.00 / 07.2013	Original software	V01.01.02.10 and higher	V5.00.02.04 and higher	BA012090/09/01.13

## 12 Maintenance

No special maintenance work is required for the device.

### 12.1 Updating the device software ("firmware")

Updating the device software ("firmware") via USB stick, SD card or web server.

-  The device software ("firmware") should only be updated by a service technician. It is advisable to save the setup and measured values beforehand on the SD card or USB stick.

### 12.2 Instructions for enabling a software option

Various device options can be enabled via an activation code. Available device options can be ordered as an accessory (→  53). Once you place your order, you receive instructions on how to activate the option and a code which you must enter under **"Main menu -> Expert -> System -> Device options -> Activation code"**.

### 12.3 Cleaning

The front of the housing can be cleaned with a clean dry or damp cloth.

## 13 Repair

### 13.1 General notes

- i** Repairs that are not described in these Operating Instructions must only be carried out directly by the manufacturer or by the service department.
- i** If ordering spare parts, please specify the serial number of the unit! Installation instructions are included with the spare part.

### 13.2 Spare parts

- i** If required, contact your supplier.

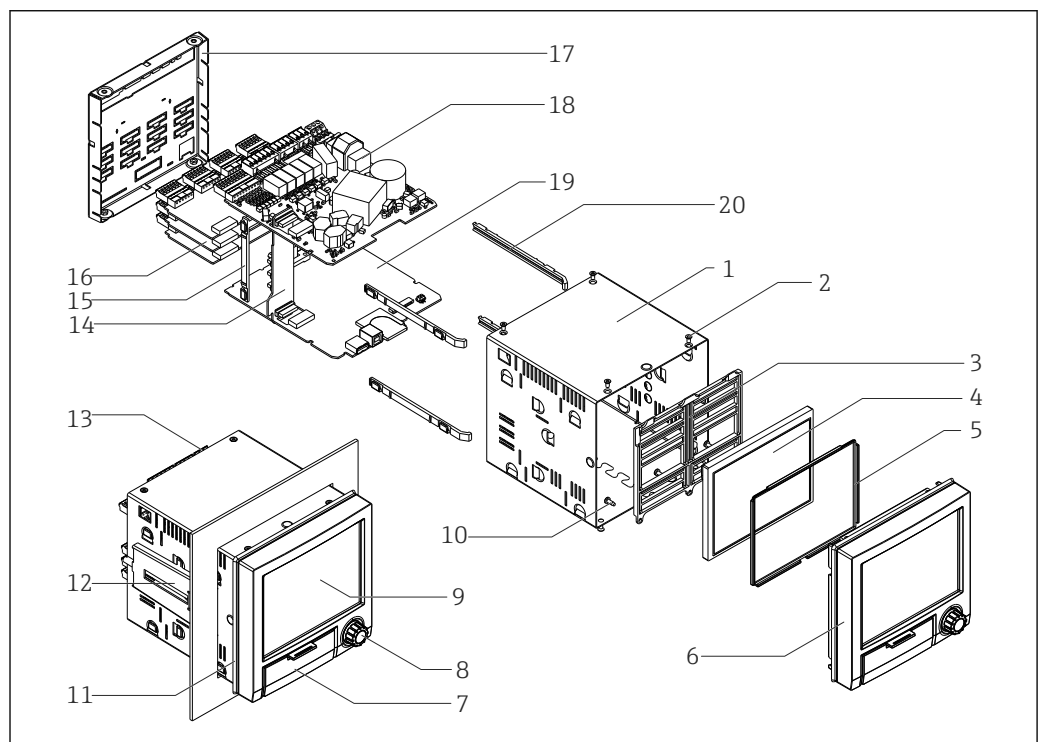

A0019863

**9** Spare parts diagram

Spare parts list:

Pos.	Description
1	Tubu
12	Jack screw short (1 piece)
11	Sealing housing
16	Analog board, 4 channel
4	Display TFT 5.7" VGA + ribbon cable
3, 5, 10	Spare parts kit display
6, 7, 8	Front neutral + navigator + ribbon cable
15, 20	Spare parts kit card holder
14	Motherboard
18	Power supply 24 V AC/DC

Pos.	Description
18	Power supply 100-230 V AC (+/-10%)
17	Real panel with laser printing
13	<b>Terminals:</b>
	Terminal plug 3 pole "N L PE" pitch 5.08 color orange
	Screw terminal 3 pole FKC2,5/3-ST-5,08 for relay 1
	Screw terminal 4 pole FKC2,5/4-ST-5,08 for relay 2+3
	Screw terminal 6 pole FKC2,5/6-ST-5,08 for relay 4+5+6
	Terminal strip 9 pole FMC1,5/9-ST-3,5 for digital inputs
	Terminal strip 6 pole FMC1,5/6-ST-3,5 for analog input

#### Order structure for CPU with software

Pos.	Description
19	<b>CPU + Software</b>
	<b>Operation Language:</b> Universal
	<b>Software:</b> Standard Mathematic
	<b>Communication:</b> Ethernet RJ45 + USB RS232/485 + Ethernet RJ45 + USB Modbus TCP Slave + Ethernet RJ45 + USB Modbus RTU/TCP Slave + RS232/485 + Ethernet RJ45 + USB

#### Order structure for option retrofit

Pos.	Description
	<b>Option retrofit</b> (It is necessary to indicate the serial number!)
	<b>Software:</b> Standard Option mathematic
	<b>Option:</b> Standard Modbus TCP Slave (Modbus RTU only with RS485)
	 For option Modbus RTU a RS485 interface is required. If there is no RS485 interface in the device, a new CPU board must be ordered.

 This software option can be directly activated on the device. After ordering you'll receive an instruction and a code for activating the software.

### 13.3 Return

The device must be packed in protective packaging if it is being returned for repair, for example. The original packaging offers the best protection. Repairs may only be performed by your supplier's service organization.

 When sending for repair, please enclose a note with a description of the error and the application.

## 13.4 Disposal

The device contains electronic components and must therefore be disposed of as electronic waste. Please pay particular attention to the national disposal regulations in your country.

## 14 Accessories

 When ordering accessories, please quote the serial number of the device! The accessory parts content installation instructions!

 If required, contact your supplier.

### 14.1 Device-specific accessories

Description
SD memory card "Industrial Grade", 1GB
Field housing
Desktop housing
SQL-evaluation software based on database (1x workplace Licence)
OPC-Server software (Full version on CD)

### 14.2 Communication-specific Accessories

Description
<b>Accessories data manager</b>
<b>Description:</b> Cable set RS232 with plug + 9-pin-Sub-D. plug for connection PC or modem Converter USB - RS232 Cable USB-A - USB-B, 2 m

## 15 Technical Data

### 15.1 Function and system design

---

#### Measuring principle

Electronic acquisition, display, recording, analysis, remote transmission and archiving of analog and digital input signals.

The device is intended for installation in a panel or cabinet. There is also the option of operating it in a desktop housing or field housing.

---

#### Measuring system

Multichannel data recording system with multicolored TFT display (145 mm / 5.7" screen size), galvanically isolated universal inputs (U, I, TC, RTD, pulse, frequency), digital inputs, transmitter power supply, limit relay, communication interfaces (USB, Ethernet, optional RS232/485), optionally available with Modbus protocol, 128 MB internal memory, external SD card and USB stick. An Essential Version of the reporting software is included for SQL-supported data analysis at the PC.

 The number of inputs available in the basic device can be individually increased using a maximum of 3 plug-in cards. The device supplies power directly to connected two-wire transmitters. The device is configured and operated via the navigator (jog/shuttle dial), via the integrated web server and a PC, or via an external keyboard. Online help facilitates local operation.

---

#### Reliability

##### Dependability

Depending on the device version, the MTBF is between 52 years and 24 years (calculated based on SN29500 standard at 40°C)

##### Serviceability

Battery-backed time and data memory. It is advisable to have the backup battery replaced by a service technician after 10 years.

##### Standard diagnostic functions as per Namur NE 107

The diagnostic code is made up of the error category as per Namur NE 107 and the message number.

- Cable open circuit, short-circuit
- Incorrect wiring
- Internal device errors
- Overrange/underrange detection
- Ambient temperature out-of-range detection

##### Device error/alarm relay

One relay can be used as an alarm relay. If the device detects a system error (e.g. hardware defect) or a malfunction (e.g. cable open circuit), the selected output/relay switches.

This "alarm relay" switches if "F"-type errors occur (F = failure), i.e. "M"-type errors (M= Maintenance required) do not switch the alarm relay.

##### Safety

The tamper-proof recorded data are saved and can be transferred to an external SQL database for archiving in a way that prevents subsequent manipulation.

## 15.2 Input

### Measured variables

#### Number of analog universal inputs

Standard version without universal inputs. Optional input cards (slot 1-3) with 4 universal inputs (4/8/12) each.

#### Number of digital inputs

6 digital inputs

#### Number of mathematics channels

4 mathematics channels (optional). Mathematics functions can be freely edited via a formula editor.

#### Number of limit values

30 limit values (individual channel assignment)

#### Function of analog universal inputs

You are free to choose between the following measured variables for each universal input: U, I, RTD, TC, pulse input or frequency input.

#### Calculated values

The values of the universal inputs can be used to perform calculations in the mathematics channels.

### Measuring range of analog universal inputs

According to IEC 60873-1: An additional display error of  $\pm 1$  digit is permitted for every measured value.

### Measuring ranges which can be selected per universal input:

Measured variable	Measuring range	Maximum measured error of measuring range (oMR), RTD temperature drift	Input impedance
Current (I)	0 to 20 mA; 0 to 20 mA quadratic 0 to 5 mA 4 to 20 mA; 4 to 20 mA quadratic -20 to 20 mA Overrange: up to 22 mA or -22 mA	$\pm 0.1\%$ oMR	Load: 50 Ohm $\pm 1$ Ohm
Voltage (U) >1 V	0 to 10 V; 0 to 10 V quadratic 0 to 5 V 1 to 5 V; 1 to 5 V quadratic $\pm 10$ V $\pm 30$ V	$\pm 0.1\%$ oMR	$\geq 1$ MOhm
Voltage (U) $\leq 1$ V	0 to 1 V; 0 to 1 V quadratic $\pm 1$ V $\pm 150$ mV	$\pm 0.1\%$ oMR	$\geq 2.5$ MOhm
Resistance thermometer (RTD)	Pt100: -200 to 850 °C (-328 to 1562 °F) (IEC751, GOST) Pt100: -200 to 510 °C (-328 to 950 °F) (JIS1604-1984) Pt500: -200 to 500 °C (-328 to 932 °F) (IEC751) Pt500: -200 to 510 °C (-328 to 950 °F) (JIS1604-1984) Pt1000: -200 to 250 °C (-328 to 482 °F) (IEC751) Pt1000: -200 to 510 °C (-328 to 950 °F) (JIS1604-1984)	4-wire: $\pm 0.1\%$ oMR 3-wire: $\pm (0.1\% \text{ oMR} + 0.8 \text{ K})$ 2-wire: $\pm (0.1\% \text{ oMR} + 1.5 \text{ K})$ Temperature drift: $\pm 0.01\%/K$ oMR	
	Cu100: -50 to 200 °C (-58 to 392 °F) (GOST) Cu50: -50 to 200 °C (-58 to 392 °F) (GOST, $\alpha = 4260$ ppm/K) Cu50: -175 to 200 °C (-347 to 392 °F) (GOST, $\alpha = 4280$ ppm/K) Pt50: -185 to 1100 °C (-365 to 2012 °F) (GOST)	4-wire: $\pm 0.2\%$ oMR 3-wire: $\pm (0.2\% \text{ oMR} + 0.8 \text{ K})$ 2-wire: $\pm (0.2\% \text{ oMR} + 1.5 \text{ K})$ Temperature drift: $\pm 0.02\%/K$ oMR	

Measured variable	Measuring range	Maximum measured error of measuring range (oMR), RTD temperature drift	Input impedance
	Cu53: -50 to 180 °C (-58 to 356 °F) (GOST, $\alpha = 4280$ ppm/K) Pt46: -200 to 650 °C (-328 to 1202 °F) (GOST)	4-wire: $\pm 0.3\%$ oMR 3-wire: $\pm(0.3\% \text{ oMR} + 0.8 \text{ K})$ 2-wire: $\pm(0.3\% \text{ oMR} + 1.5 \text{ K})$ Temperature drift: $\pm 0.01\%/K$ oMR	
Thermocouples (TC)	Type J (Fe-CuNi): -210 to 1200 °C (-346 to 2192 °F) (IEC581-1) Type K (NiCr-Ni): -270 to 1300 °C (-454 to 2372 °F) (IEC581-1) Type T (Cu-CuNi): -270 to 400 °C (-454 to 752 °F) (IEC581-1) Type N (NiCrSi-NiSi): -270 to 1300 °C (-454 to 2372 °F) (IEC581-1) Type L (Fe-CuNi): -200 to 900 °C (-328 to 1652 °F) (DIN43710) Type L (Fe-CuNi): -200 to 659 °C (-328 to 1218.2 °F) (GOST)	$\pm 0.1\%$ oMR from -100 °C (-148 °F) $\pm 0.1\%$ oMR from -130 °C (-202 °F) $\pm 0.1\%$ oMR from -200 °C (-328 °F) $\pm 0.1\%$ oMR from -100 °C (-148 °F) $\pm 0.1\%$ oMR from -100 °C (-148 °F) $\pm 0.1\%$ oMR from -100 °C (-148 °F)	$\geq 1$ MOhm
	Type D (W3Re-W25Re): 0 to 2315 °C (32 to 4199 °F) (ASTME988) Type C (W5Re-W26Re): 0 to 2315 °C (32 to 4199 °F) (ASTME988) Type B (Pt30Rh-Pt6Rh): 40 to 1820 °C (104 to 3308 °F) (IEC581-1) Type S (Pt10Rh-Pt): -50 to 1768 °C (-58 to 3214 °F) (IEC581-1) Type R (Pt13Rh-Pt): -50 to 1768 °C (-58 to 3214 °F) (IEC581-1) Type A (W5Re-W20Re): 0 to 2500 °C (32 to 4532 °F) (ASTME988)	$\pm 0.15\%$ oMR from 500 °C (932 °F) $\pm 0.15\%$ oMR from 500 °C (932 °F) $\pm 0.15\%$ oMR from 600 °C (1112 °F) $\pm 0.15\%$ oMR from 100 °C (212 °F) $\pm 0.15\%$ oMR from 100 °C (212 °F) $\pm 0.15\%$ oMR from 500 °C (932 °F)	$\geq 1$ MOhm
Pulse input (I)	Min. pulse length 40 $\mu$ s, max. 12.5 kHz; 0 to 7 mA = LOW; 13 to 20 mA = HIGH	$\pm 0.02\%$ @ $f < 100$ Hz $\pm 0.01\%$ @ $f \geq 100$ Hz Temperature drift: 0.01% of measured value over the entire temperature range	Load: 50 Ohm $\pm 1$ Ohm
Frequency input (I)	0 to 10 kHz, overrange: up to 12.5 kHz; 0 to 7 mA = LOW; 13 to 20 mA = HIGH		

### Maximum load of inputs

Limit values for input voltage and current as well as cable open circuit detection/line influence/temperature compensation:

Measured variable	Limit values (steady-state, without destroying input)	Cable open circuit detection/line influence/temperature compensation
Current (I)	Maximum permitted input voltage: 2.5 V Maximum permitted input current: 50 mA	4 to 20 mA range with disengageable cable open circuit monitoring to NAMUR NE43. The following error ranges apply when NE43 is switched on: $\leq 3.8$ mA: underrange $\geq 20.5$ mA: overrange $\leq 3.6$ mA or $\geq 21.0$ mA: open circuit (display shows: - - - -)
Pulse, frequency (I)	Maximum permitted input voltage: 2.5 V Maximum permitted input current: 50 mA	No cable open circuit monitoring
Voltage (U) >1 V	Maximum permitted input voltage: 35 V	1 to 5 V range with disengageable cable open circuit monitoring: $< 0.8$ V or $> 5.2$ V: cable open circuit (display shows: - - - -)
Voltage (U) $\leq 1$ V	Maximum permitted input voltage: 24 V	
Resistance thermometer (RTD)	Measuring current: $\leq 1$ mA	Maximum barrier resistance (or line resistance): 4-wire: max. 200 Ohm; 3-wire: max. 40 Ohm Maximum influence of barrier resistance (or line resistance) for Pt100, Pt500 and Pt1000: 4-wire: 2 ppm/Ohm, 3-wire: 20 ppm/Ohm Maximum influence of barrier resistance (or line resistance) for Pt46, Pt50, Cu50, Cu53, Cu100 and Cu500: 4-wire: 6 ppm/Ohm, 3-wire: 60 ppm/Ohm Cable open circuit monitoring if any connection is interrupted.
Thermocouples (TC)	Maximum permitted input voltage: 24 V	Cable open circuit detection from 50 kOhm Influence of wire resistance in event of open circuit detection: $< 0.001\%$ /Ohm Error, internal temperature compensation: $\leq 2$ K

### Scan rate

Current/voltage/pulse/frequency input: 100 ms per channel

Thermocouples and resistance temperature detector: 1 s per channel



**Data storage / save cycle**

Selectable save cycle. Choose from: 1s / 2s / 3s / 4s / 5s / 10s / 15s / 20s / 30s / 1min / 2min / 3min / 4min / 5min / 10min / 15min / 30min / 1h

**Converter resolution**

24 bit

**Totalization**

The interim, daily, monthly and yearly value and the total value can be determined (13-digit, 64 bit).

**Analysis**

Recording of quantity/operating time (standard function), also a min/max/median analysis within the set time frame.

Digital inputs	<b>Input level</b>	To IEC 61131-2: logical "0" (corresponds to -3 to +5 V), activation with logical "1" (corresponds to +12 to +30 V)
	<b>Input frequency</b>	Max. 25 Hz
	<b>Pulse length</b>	Min. 20 ms
	<b>Input current</b>	Max. 2 mA
	<b>Input voltage</b>	Max. 30 V

**Selectable functions**

- Functions of the digital input: control input, ON/OFF message, pulse counter (13-digit, 64 bit), operating time, message+operating time, quantity from time, Modbus slave.
- Functions of the control input: start recording, screen saver on, lock setup, time synchronization, limit monitoring on/off, lock keyboard/navigator, start/stop analysis.

## 15.3 Output

Auxiliary voltage output The auxiliary voltage output can be used for loop power supply or to control the digital inputs. The auxiliary voltage is short-circuit proof and galvanically isolated.

<b>Output voltage</b>	24 V <sub>DC</sub> ±15%
<b>Output current</b>	Max. 250 mA

Galvanic isolation

*All inputs and outputs are galvanically isolated from each other and designed for the following testing voltages:*

	Relay	Digital in	Analog in	Ethernet	RS232/RS485	USB	Auxiliary voltage output
Relay	500 V <sub>DC</sub>	2 kV <sub>DC</sub>	2 kV <sub>DC</sub>	2 kV <sub>DC</sub>	2 kV <sub>DC</sub>	2 kV <sub>DC</sub>	2 kV <sub>DC</sub>
Digital in	2 kV <sub>DC</sub>	Galvanically connected	500 V <sub>DC</sub>	500 V <sub>DC</sub>	500 V <sub>DC</sub>	500 V <sub>DC</sub>	500 V <sub>DC</sub>
Analog in	2 kV <sub>DC</sub>	500 V <sub>DC</sub>	500 V <sub>DC</sub>	500 V <sub>DC</sub>	500 V <sub>DC</sub>	500 V <sub>DC</sub>	500 V <sub>DC</sub>
Ethernet	2 kV <sub>DC</sub>	500 V <sub>DC</sub>	500 V <sub>DC</sub>	-	500 V <sub>DC</sub>	500 V <sub>DC</sub>	500 V <sub>DC</sub>

	Relay	Digital in	Analog in	Ethernet	RS232/RS485	USB	Auxiliary voltage output
RS232/RS485	2 kV <sub>DC</sub>	500 V <sub>DC</sub>	500 V <sub>DC</sub>	500 V <sub>DC</sub>	-	500 V <sub>DC</sub>	500 V <sub>DC</sub>
USB	2 kV <sub>DC</sub>	500 V <sub>DC</sub>	500 V <sub>DC</sub>	500 V <sub>DC</sub>	500 V <sub>DC</sub>	Galvanically connected	500 V <sub>DC</sub>
Auxiliary voltage output	2 kV <sub>DC</sub>	500 V <sub>DC</sub>	500 V <sub>DC</sub>	500 V <sub>DC</sub>	500 V <sub>DC</sub>	500 V <sub>DC</sub>	-

## Relay outputs

A mix of low voltage (230 V) and safety extra low voltage (SELV circuits) is not permitted at the connections of the relay contacts.

### Alarm relay

1 alarm relay with changeover contact.

### Standard relay

5 relays with NO contact, e.g. for limit value messages (can be configured as NC contact).

### Relay switching capacity

- Max. switching capacity: 3 A@ 30 V DC
- Max. switching capacity: 3 A@ 250 V AC
- Min. switching load: 300 mW

### Switching cycles

>10<sup>5</sup>

## Cable specification

### Cable specification, spring terminals

All connections to the rear of the unit are designed as screw or spring terminal blocks with reverse polarity protection. This makes the connection very quick and easy. The spring terminals are unlocked with a slotted screwdriver (size 0).

Please note the following when connecting:

- Wire cross-section, auxiliary voltage output, digital I/O and analog I/O: max. 1.5 mm<sup>2</sup> (14 AWG) (spring terminals)
- Wire cross-section, power supply: max. 2.5 mm<sup>2</sup> (13 AWG) (screw terminals)
- Wire cross-section, relays: max. 2.5 mm<sup>2</sup> (13 AWG) (spring terminals)
- Stripping length: 10 mm (0.39 in)

 No ferrules have to be used when connecting flexible wires to spring terminals.

### Cable type

 Use shielded signal lines for interfaces!

## 15.4 Power supply

### Terminal assignment

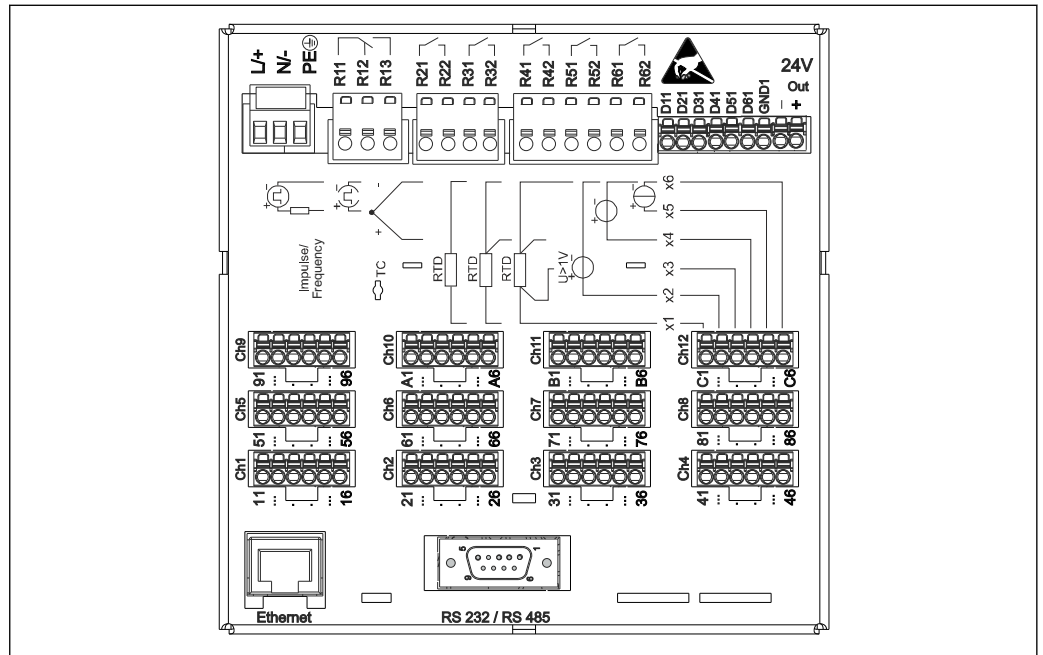

10 Terminals on back of device

### Supply voltage

- Extra-low voltage power supply unit  $\pm 24$  V AC/DC (-10% / +15%) 50/60Hz
  - Low voltage power supply unit 100 to 230 V AC ( $\pm 10\%$ ) 50/60Hz
- i** An overload protection element (rated current  $\leq 10$  A) is required for the power cable.

### Power consumption

- 100 to 230 V: max. 35 VA
- 24 V: max. 24 VA

The power actually consumed depends on the individual operating state and the device version (LPS, USB, brightness of screen, number of channels, etc). The active power here is approx. 3 W to 20 W.

### Power supply failure

Battery-backed time and data memory. The device starts automatically following a power failure.

### Electrical connection

Details about the electrical connection: ( $\rightarrow$  11)

### Device plug

- Panel-mounted device: connected to mains via plug-in screw terminals with reverse polarity protection
- Desktop version (option): connected to mains via regular-temperature C13/C14 coupler

### Overvoltage protection

To avoid high-energy transients on long signal cables, connect a suitable surge arrester upstream (e.g. E+H HAW562).

Interface, communication  
connection data

#### USB ports (standard):

*1 x USB port type A (host)*

A USB 2.0 connection is available on a shielded USB A socket at the front of the device. A USB stick, for example, can be connected to this interface as a storage medium. An external keyboard or USB hub may also be connected.

*1 x USB port type B (function)*

A USB 2.0 connection is available on a shielded USB B socket at the front of the device. This can be used to connect the device for communication with a laptop, for example.

#### Ethernet interface (standard):

Ethernet interface on back, 10/100 Base-T, plug type RJ45. The Ethernet interface can be used to integrate the device via a hub or switch into a PC network (TCP/ IP Ethernet). A standard patch cable (e.g. CAT5E) can be used for the connection. Using DHCP, the device can be fully integrated into an existing network without the need for additional configuration. The device can be accessed from every PC in the network. Normally only the automatic assignment of the IP address must be configured at the client. When the device is started, it can automatically retrieve the IP address, subnet mask and gateway from a DHCP server. If a DHCP is not used, these settings must be made directly in the device (depends on the network to which the device is to be connected). Two Ethernet function LEDs are located on the rear of the device.

#### Serial RS232/RS485 interface (option):

A combined RS232/RS485 connection is available on a shielded SUB D9 socket at the rear of the device. This can be used for data or program transfer and to connect a modem. For communication via modem, we recommend an industrial modem with a watchdog function.

- The following baud rates are supported: 9600, 19200, 38400, 57600, 115200
- Max. line length with shielded cable: 2 m (6.6 ft) (RS232), or 1000 m (3281 ft) (RS485)

 Only one interface can be used at any one time (RS232 or RS485).

## 15.5 Performance characteristics

Response time

Input	Output	Time [ms]
Current, voltage, pulse	Relay	≤ 550
RTD	Relay	≤ 1150
TC <sup>1)</sup>	Relay	≤ 1550
Cable open circuit detection, current input	Relay	≤ 1150
Cable open circuit detection, RTD, TC	Relay	≤ 5000
Digital input	Relay	≤ 350
HART input	Relay	Non-deterministic

1) If internal measuring point temperature compensation is used, otherwise values as for voltage

Reference operating  
conditions

Reference temperature	25 °C (77 °F) ±5 K
Warm-up period	120 min.
Humidity	20 to 60 % rel. humidity

Hysteresis	Can be configured for limit values in the setup
Long-term drift	To IEC 61298-2: max. $\pm 0.1\%$ /year (of measuring range)

## 15.6 Installation

Mounting location and installation dimensions

The device is designed for use in a panel in non-hazardous areas.

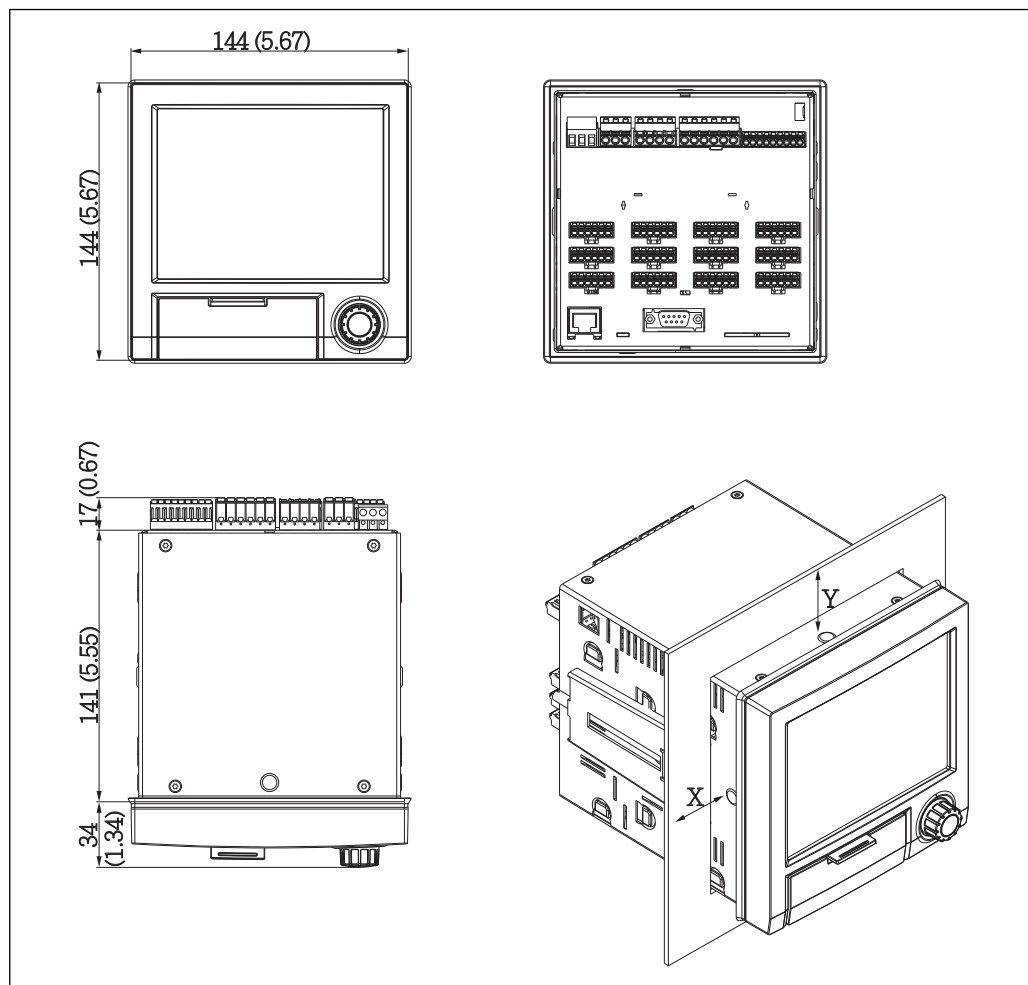

11 Panel mounting and dimensions in mm (in)

Please observe the installation depth of approx. 158 mm (6.22 in) for the device incl. terminals and fastening clips.

- Panel cutout: 138 to 139 mm (5.43 to 5.47 in) x 138 to 139 mm (5.43 to 5.47 in)
- Panel strength: 2 to 40 mm (0.08 to 1.58 in)
- Angle of vision: from the midpoint axis of the display, 75° to the left and right, 65° above and below.
- A minimum distance of 15 mm (0.59 in) mm (inch) between the devices must be observed if aligning the devices in the Y-direction (vertically above one another). A minimum distance of 10 mm (0.39 in) mm (inch) between the devices must be observed if aligning the devices in the X-direction (horizontally beside one another).
- Securing to DIN 43 834

Field housing assembly and design (optional) As an option, the device can be ordered ready-mounted in a field housing with IP65.  
Dimensions (B x H x D) approx.: 320 mm (12.6 in) x 320 mm (12.6 in) x 254 mm (10 in)

Desktop housing assembly and design (optional) As an option, the device can be ordered ready-mounted in a desktop housing.  
Dimensions (B x H x D) approx.: 293 mm (11.5 in) x 188 mm (7.4 in) x 211 mm (8.3 in)  
(dimensions with bracket, feet and installed device)

## 15.7 Environment

Ambient temperature range -10 to +50 °C (14 to 122 °F)

Storage temperature -20 to +60 °C (-4 to +140 °F)

Humidity 5 to 85 %, non-condensing

Climate class To IEC 60654-1: Class B2

Altitude < 2 000 m (6 561 ft) over MSL

Degree of protection	<b>Front</b>	IP65 / NEMA 4
	<b>Rear</b>	IP20

Electromagnetic compatibility

- Interference immunity: To IEC 61326 (industrial environment) / NAMUR NE 21
- Interference emissions: To IEC 61326, Class A

## 15.8 Mechanical construction

Design, dimensions Information about design and dimensions (→  61)

Weight

- Panel-mounted device with maximum configuration: approx. 2.2 kg (4.85 lbs)
- Desktop housing (excluding device): approx. 2.3 kg (5 lbs)
- Field housing (excluding device): approx. 4 kg (8.8 lbs)

Materials	Front frame	Zinc die cast GD-Z410, powder-coated
	Sight glass	Transparent Makrolon plastic (FR clear 099) UL94-V2
	Flap; jog/shuttle dial	Plastic ABS UL94-V2
	Mounting guide rail for PCBs; motherboard fixing unit; display retainer plate	Plastic PA6-GF15 UL94-V2
	Seal to panel wall; seal to display; seal in flap; seal to navigator	Rubber EPDM 70 Shore A
	Casing; rear panel	Galvanized sheet steel St 12 ZE

 All materials are silicone-free.

**Materials of desktop housing**

- Housing half-panels: sheet steel, electrolytically plated (powder-coated)
- Side sections: aluminum extruded section (powder-coated)
- Section ends: colored polyamide

## 15.9 Display and operating elements

Operating concept

The device can be operated directly onsite, or via remote configuration with the PC via interfaces and operating tools (web server).

**Integrated operating instructions**

The unit's simple control system enables you to perform commissioning for many applications without the need for hardcopy operating instructions. The device has an integrated help function and displays operating instructions directly on screen if the navigator (jog/shuttle dial) is pressed for longer than 3 seconds.

Local operation

**Operating elements**

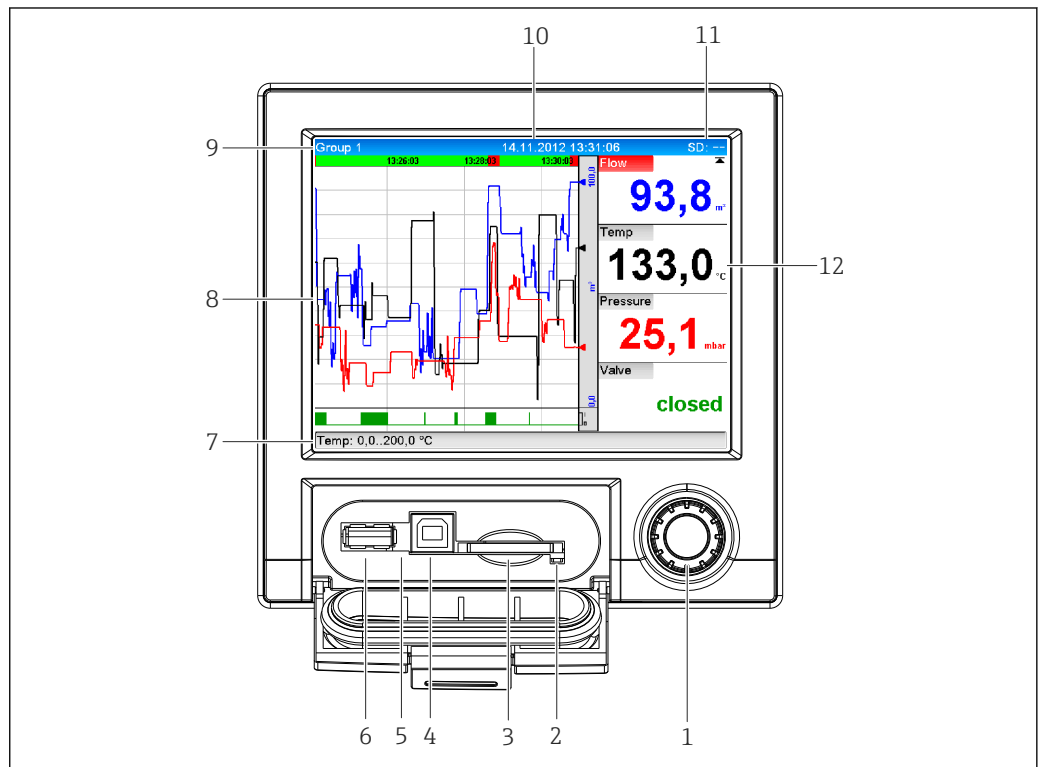

 12 Front of device with open flap

A0020602-EN

Item No.	Operating function (display mode = display of measured values) (Setup mode = operating in the Setup menu)
1	"Navigator": jog/shuttle dial for operating with additional press function. In Display mode: turn the dial to switch between the various signal groups. Press the dial to display the main menu. In Setup mode or in a selection menu: turn the dial anticlockwise to move the bar or the cursor upwards or counterclockwise, changes the parameter. Turning clockwise moves the bar or cursor down or clockwise, changes parameter.
2	LED at SD slot. Orange LED lit when the device writes to the SD card or reads it.
3	Slot for SD card
4	USB B socket "Function" e.g. to connect to PC or laptop
5	Green LED lit: Power supply present
6	USB A socket "Host" e.g. for USB memory stick or external keyboard
7	In Display mode: alternating status display (e.g. set zoom range) of the analog or digital inputs in the appropriate color of the channel. In Setup mode: different information can be displayed here depending on the display type.
8	In Display mode: window for measured value display (e.g. curve display). In Setup mode: display of operating menu
9	In Display mode: current group name, type of evaluation In Setup mode: name of the current operating item (dialog title)
10	In Display mode: displays current date/time In Setup mode: --
11	In Display mode: alternating display indicating the percentage space on the SD card or USB stick that has already been used. Status symbols are also displayed in alternation with the memory information. In Setup mode: the current "direct access" operating code is displayed
12	In Display mode: display of current measured values and the status in the event of an error/alarm condition. In the case of counters, the type of counter is displayed as a symbol.  If a measuring point has limit value status, the corresponding channel identifier is highlighted in red (quick detection of limit value violations). During a limit value violation and device operation, the acquisition of measured values continues uninterrupted.

## Languages

The following languages can be selected in the operating menu: German, English, Spanish, French, Italian, Dutch, Swedish, Polish, Portuguese, Czech, Russian, Japanese, Chinese (Traditional), Chinese (Simplified)

## Remote operation

**Device access via operating tools**

Device configuration and measured value retrieval can also be done via interfaces. The following operating tools are available for this purpose:

Operating tool	Functions	Access via
Analysis software, SQL database support (included in scope of delivery)	<ul style="list-style-type: none"> <li>▪ Export of saved data (measured values, analyses, event log)</li> <li>▪ Visualization and processing of saved data (measured values, analyses, event log)</li> <li>▪ Safe archiving of exported data in a SQL database</li> </ul>	RS232/RS485, USB, Ethernet
Web server (integrated into the device; access via browser)	<ul style="list-style-type: none"> <li>▪ Display of current and historical data and measured value curves via the web browser</li> <li>▪ Easy configuration without additional installed software</li> <li>▪ Remote access to device and diagnostic information</li> </ul>	Ethernet



OPC server (optional)	The following momentary values can be provided: <ul style="list-style-type: none"> <li>■ Analog channels</li> <li>■ Digital channels</li> <li>■ Mathematics</li> <li>■ Totalizer</li> </ul>	RS232/RS485, USB, Ethernet
-----------------------	---	----------------------------

**System integration** The device has (optional) fieldbus interfaces for exporting process values. Measured values and statuses can also be transmitted to the device via fieldbus. Depending on the bus system, alarms or faults occurring during data transmission are displayed (e.g. status byte). The process values are transferred in the same devices that are used for display at the device.

#### **Ethernet**

The following functions are implemented:

- Data communication with PC software (analysis software, OPC server)
- Web server

#### **Modbus RTU/TCP slave**

The device can be connected to a Modbus system via RS485 or Ethernet interface. Up to 12 analog inputs and 6 digital inputs can be transmitted via Modbus and stored in the device.

## **15.10 Certificates and approvals**

**CE mark**

#### **Declaration of Conformity**

The product meets the requirements of the harmonized European standards. As such, it complies with the legal specifications of the EC directives. The manufacturer confirms successful testing of the product by affixing to it the **CE** mark.

**Other standards and guidelines**

- IEC 60529:  
Degrees of protection provided by enclosures (IP code)
- IEC 61010-1: 2001 Cor 2003  
Safety requirements for electrical equipment for measurement, control and laboratory use

## **15.11 Ordering information**

**Scope of delivery**

The scope of delivery of the device comprises:

- Device (with terminals, as per your order)
- 2 fastening clips
- USB cable
- Optional: Industrial grade SD card (card is located in the device).
- Analysis software on CD-ROM

- Delivery note
- Multilanguage Operating Instructions on CD-ROM

## 16 Addition

### 16.1 Operating items in the "Expert" menu

The parameter groups for the Expert setup contain all the parameters of the operating menus: System, Input and Output Setup, Communication, Application, Diagnostics as well as other parameters that are reserved for experts only.

 For most settings, the "Setup" or "Expert" menu must be quit before the settings are adopted. However settings such as the date/time are accepted immediately.

---

#### Direct access

---

<b>Navigation</b>	 Expert → Direct access
<b>Description</b>	Direct access to active operating items (rapid access). Entering the direct access code takes you directly to the desired operating parameter. The direct access code is displayed in the Setup menu on the top right of the display (e.g. 00000-000).
<b>Text entry</b>	(e.g. 00000-000)

#### 16.1.1 "System" submenu

Basic settings that are needed to operate the device (e.g. date, time, etc.)

---

#### Language

---

<b>Navigation</b>	 Expert → System → Language Direct access code: 010000-000
<b>Description</b>	Select unit operating language
<b>Options</b>	German, English, Spanish, French, Italian, Dutch, Swedish, Polish, Portuguese, Czech, Russian, Japanese, Chinese (Traditional), Chinese (Simplified)
<b>Factory setting</b>	English; or preset to customer's preferred language

---

#### Device tag

---

<b>Navigation</b>	 Expert → System → Device tag Direct access code: 000031-000
<b>Description</b>	Individual device tag
<b>User entry</b>	Text entry (max. 17 characters)
<b>Factory setting</b>	Unit 1

---

**Temp. unit**



---

<b>Navigation</b>	 Expert → System → Temp. unit Direct access code: 100001-000
<b>Description</b>	Selection of temperature unit. All directly connected thermocouples or resistance thermometers (RTD) are displayed in the preset engineering units.
<b>Options</b>	°C, °F, K
<b>Factory setting</b>	°C

---

**Decimal separator**



---

<b>Navigation</b>	 Expert → System → Decimal separator Direct access code: 100003-000
<b>Description</b>	Select in which form the decimal separator character is to be displayed
<b>Options</b>	Comma, point
<b>Factory setting</b>	Comma

---

**Fault switching**



---

<b>Navigation</b>	 Expert → System → Fault switching Direct access code: 100002-000
<b>Description</b>	If the device detects a system error (e.g. hardware defect) or a fault (e.g. cable open circuit), the selected output switches.
<b>Options</b>	Not used, Relay x All the available relays are displayed.
<b>Factory setting</b>	Relay 1

---

**Keyboard layout**

---



<b>Navigation</b>	 Expert → System → Keyboard layout Direct access code: 100020/000
<b>Description</b>	Please select the keyboard layout. Only relevant if external keyboard is used.

<b>Options</b>	Germany, Switzerland, France, USA, USA International, UK, Italy
<b>Factory setting</b>	Germany

---

**PRESET**



---

<b>Navigation</b>	 Expert → System → PRESET Direct access code: 000044-000
<b>Description</b>	Caution: Resets all the parameters to the factory settings!  Only visible/editable if the service code has been entered.
<b>Options</b>	No, Factory reset, Customer setting

---

**Clear memory**



---

<b>Navigation</b>	 Expert → System → Clear memory Direct access code: 059000-000
<b>Options</b>	No, Yes

---

**"Date/time set-up" submenu**



---

<b>Navigation</b>	 Expert → System → Date/time set-up
<b>Description</b>	Contains settings for date/time.

---

**Date format**



---

<b>Navigation</b>	 Expert → System → Date/time set-up → Date format Direct access code: 110000-000
<b>Description</b>	Select in which format the date is to be set and displayed.
<b>Options</b>	DD.MM.YYYY, MM/DD/YYYY, YYYY-MM-DD
<b>Factory setting</b>	DD.MM.YYYY

---

**Time format**



---

<b>Navigation</b>	 Expert → System → Date/time set-up → Time format Direct access code: 110001-000
<b>Description</b>	Select in which format the time is to be set and displayed.
<b>Options</b>	24 hour, 12 hour AM/PM
<b>Factory setting</b>	24 hour

---

#### "Date/time" submenu

---

<b>Navigation</b>	 Expert → System → Date/time set-up → Date/time
<b>Description</b>	Contains parameters for setting the date/time.

---

#### UTC time zone

---

<b>Navigation</b>	 Expert → System → Date/time set-up → Date/time → UTC time zone Direct access code: 120000-000
<b>Description</b>	Display of the current UTC time zone is on (UTC = universal time coordinated).

---

#### Current date/time

---

<b>Navigation</b>	 Expert → System → Date/time set-up → Date/time → Current date/time Direct access code: 120003-000
<b>Description</b>	Displays the current date and the current time.

---

#### "Change date/time" submenu

---

<b>Description</b>	Contains parameters for changing the date/time.
<b>Navigation</b>	 Expert → System → Date/time set-up → Change date/time

---

#### UTC time zone

---

<b>Navigation</b>	 Expert → System → Date/time set-up → Date/time → Change date/time → UTC time zone Direct access code: 120010-000
<b>Description</b>	Set your UTC time zone (UTC = universal time coordinated).

**Options** -12:00, -11:00: Samoa, -10:00: Hawaii, -09:30: Marquesas, -09:00: Alaska, -08:00: LA, -07:00: Denver, -06:00: Chicago, -05:00: New York, -04:00: Caracas, -03:30: St.John's, -03:00: Brasilia, -02:00: Atlantic, -01:00: Azores, +00:00: London, +01:00: Berlin, +02:00: Cairo, +03:00: Moscow, +03:30: Tehran, +04:00: Abu Dhabi, +04:30: Kabul, +05:00: Islamabad, +05:30: New Delhi, +05:45: Kathmandu, +06:00: Dhaka, +06:30: Pyinmana, +07:00: Bangkok, +08:00: Peking, +08:45, +09:00: Tokyo, +09:30: Adelaide, +10:00: Canberra, +10:30: Lord-Howe, +11:00:Solom.Isl., +11:30: Norfolk, +12:00: Auckland, +12:45: Chatham, +13:00, +14:00

---

### Date/time

---

**Navigation**  Expert → System → Date/time set-up → Date/time → Change date/time → Date/time  
Direct access code: 120013-000

**Description** Set the current date and time for the unit here.

**User entry** Date/time in set format

---

### "NT/ST changeover" submenu

---

**Navigation**  Expert → System → Date/time set-up → NT/ST changeover

**Description** Contains settings for normal time/summer time changeover.

---

### NT/ST changeover

---

**Navigation**  Expert → System → Date/time set-up → NT/ST changeover → NT/ST changeover  
Direct access code: 110002-000

**Description** Function for summer/normal time changeover. Automatic: Changes to the local regional regulations; Manual: Changeover times can be set in the following addresses ; Off: No changeover times required.

**Options** Off, Manual, Automatic

**Factory setting** Automatic

---

### NT/ST region

---

**Navigation**  Expert → System → Date/time set-up → NT/ST changeover → NT/ST region  
Direct access code: 110003-000

**Description** Selects the regional settings for summer/normal time changeover.  
Only visible if NT/ST changeover = automatic.

**Options** Europe, USA

**Factory setting** Europe

---

### Begin summer time

---

### Occurrence

---

**Navigation**  Expert → System → Date/time set-up → NT/ST changeover → Occurrence  
Direct access code: 110005-000

**Description** Day, when in the spring a change from normal to summer time occurs.  
Visible for NT/ST changeover = Automatic or Manual. Only editable if NT/ST changeover = Manual.

**Options** 1., 2., 3., 4., Last

**Factory setting** Last

---

### Day

---

**Navigation**  Expert → System → Date/time set-up → NT/ST changeover → Day  
Direct access code: 110006-000

**Description** Day, when in the spring a change from normal to summer time occurs.  
Visible for NT/ST changeover = Automatic or Manual. Only editable if NT/ST changeover = Manual.

**Options** Sunday, Monday, Tuesday, Wednesday, Thursday, Friday, Saturday

**Factory setting** Sunday

---

### Month

---

**Navigation**  Expert → System → Date/time set-up → NT/ST changeover → Month  
Direct access code: 110007-000

**Description** Month, when in the spring a change from normal to summer time occurs.  
Visible for NT/ST changeover = Automatic or Manual. Only editable if NT/ST changeover = Manual.

**Options** January, February, March, April, May, June, July, August, September, October, November, December



**Factory setting**                      March

---

### Date

---

**Navigation**                                Expert → System → Date/time set-up → NT/ST changeover → Date  
Direct access code: 110008-000

**Description**                            Date next spring when a change from normal to summer time occurs.  
Only visible if NT/ST changeover = automatic or manual. Cannot be edited.

---

### Time

---

**Navigation**                                Expert → System → Date/time set-up → NT/ST changeover → Time  
Direct access code: 110009-000

**Description**                            Time when the time is moved forward by 1 hour on the day of the changeover from normal time to summer time (in the set time format).  
Visible for NT/ST changeover = Automatic or Manual. Only editable if NT/ST changeover = Manual.

**User entry**                              Time in set time format

**Factory setting**                        02:00

---

### End summer time

---



---

### Occurrence

---

**Navigation**                                Expert → System → Date/time set-up → NT/ST changeover → Occurrence  
Direct access code: 110005-000

**Description**                            Day, when in the autumn a change from summer to normal time occurs.  
Visible for NT/ST changeover = Automatic or Manual. Only editable if NT/ST changeover = Manual.

**Options**                                  1st, 2nd, 3rd, 4th, Last

**Factory setting**                        Last

---

### Day

---

<b>Navigation</b>	 Expert → System → Date/time set-up → NT/ST changeover → Day Direct access code: 110006-000
<b>Description</b>	Day, when in the autumn a change from summer to normal time occurs. Visible for NT/ST changeover = Automatic or Manual. Only editable if NT/ST changeover = Manual.
<b>Options</b>	Sunday, Monday, Tuesday, Wednesday, Thursday, Friday, Saturday
<b>Factory setting</b>	Sunday

---

### Month

---

<b>Navigation</b>	 Expert → System → Date/time set-up → NT/ST changeover → Month Direct access code: 110007-000
<b>Description</b>	Month, when in the autumn a change from summer to normal time occurs. Visible for NT/ST changeover = Automatic or Manual. Only editable if NT/ST changeover = Manual.
<b>Options</b>	January, February, March, April, May, June, July, August, September, October, November, December
<b>Factory setting</b>	October

---

### Date

---

<b>Navigation</b>	 Expert → System → Date/time set-up → NT/ST changeover → Date Direct access code: 110008-000
<b>Description</b>	Date next autumn when summer time changes back to normal time. Only visible if NT/ST changeover = automatic or manual. Cannot be edited.

---

### Time

---

<b>Navigation</b>	 Expert → System → Date/time set-up → NT/ST changeover → Time Direct access code: 110015-000
<b>Description</b>	Time when the time is moved back by 1 hour on the day of the changeover from summer time to normal time (in the set time format). Visible for NT/ST changeover = Automatic or Manual. Only editable if NT/ST changeover = Manual.
<b>User entry</b>	Time in set time format
<b>Factory setting</b>	02:00

---

**"SNTP" submenu**

---

<b>Navigation</b>	 Expert → System → Date/time set-up → SNTP
<b>Description</b>	Contains settings for time synchronization using the Simple Network Time Protocol (SNTP).

---

**SNTP**

---

<b>Navigation</b>	 Expert → System → Date/time set-up → SNTP Direct access code: 110020-000
<b>Description</b>	If switched on, time synchronization is carried out via SNTP once a day. Note: Only possible via Ethernet. Port 123 must be open in the firewall. The user/network administrator is responsible for accuracy of the time server.
<b>Options</b>	No, Yes
<b>Factory setting</b>	No

---

**SNTP server 1**



---

<b>Navigation</b>	 Expert → System → Date/time set-up → SNTP server 1 Direct access code: 110021-000
<b>Description</b>	Please specify the address of the time server (or the IP address). Note: The DNS server must be configured (see Communication/Ethernet). Your administrator can provide the address if necessary.
<b>User entry</b>	Text field

---

**SNTP server 2**

---

<b>Navigation</b>	 Expert → System → Date/time set-up → SNTP server 2 Direct access code: 110025-000
<b>Description</b>	Shows the IP address of the time server if it was automatically allocated via DHCP. Non-editable display text.  An attempt is always made to synchronize the time via SNTP server 1 first (provided it is configured) DHCP must be switched on (see Communication/Ethernet). DHCP server: Option 42

---

**"Security" submenu**

---

<b>Navigation</b>	 Expert → System → Security
<b>Description</b>	Contains settings that protect the unit against unauthorized operation and configuration.

---

**Protected by**

---

<b>Navigation</b>	 Expert → System → Security → Protected by
<b>Description</b>	Configure how the device should be protected.
<b>Options</b>	Open access, Access code
<b>Factory setting</b>	Open access

---

**Access code**



---

<b>Navigation</b>	 Expert → System → Security → Access code Direct access code: 100000-000
<b>Description</b>	Using this code set-up access can be protected from unauthorized persons. In order to change any parameter the correct code must be entered. Factory default is "0", this means changes can be done at any time. Hint: Make a note of the code and store in a safe place.
<b>User entry</b>	4-digit number
<b>Factory setting</b>	0

---

**Set point code**

---

<b>Navigation</b>	 Expert → System → Security → Set point code Direct access code: 100030-000
<b>Description</b>	If the unit is protected by an access code a set point code can also be defined. The user can change the set points once the set point code is entered. All other operating positions remain locked, however. Only visible if an access code has been defined. Factory default: "0" means that alarm set points can only be changed by entering the access code.  Alarm set point code and access code should not be identical!
<b>User entry</b>	4-digit number

**Factory setting** 0

---

### Lock hardware

---

**Navigation**  Expert → System → Security → Lock hardware  
Direct access code: 100099-000

**Description** Device functions/interfaces that are not used can be switched off for security reasons.  
 Fieldbuses may also be affected in the case of Ethernet or the serial interface!  
Please follow the operating instructions.

**Options** Ethernet (all ports/services), USB A socket front, USB A socket back, USB B socket front, Serial interface, SD card

**Factory setting** No lock

---

### "External memory" submenu

---

**Navigation**  Expert → System → External memory

**Description** Contains settings for the external data carrier, amongst other things which data is to be stored in which format on the external data carrier.

---

### Save as

---

**Navigation**  Expert → System → External memory → Save as  
Direct access code: 140000-000

**Description** "Protected format": All data is stored in a manipulation protected encrypted format. This data can only be visualized by using our software package. "Open format": data is stored in a CSV format, this can be opened by a number of different programs (for e.g. MS Excel) (Attention: no manipulation security).

**Options** Protected format, Open format (\*.csv)

**Factory setting** Protected format

---

### SD card

---



---

### Memory build-up

---

**Navigation**  Expert → System → External memory → Memory build-up  
Direct access code: 140001-000

**Description** "Stack memory": no more data can be stored once the data carrier is full.  
"Ring memory": once the data carrier is full the oldest data is deleted so that new data can be stored (First in first out (FIFO)).

**Options** Stack memory, Ring memory (FIFO)

**Factory setting** Stack memory

---

### Warning at

---

**Navigation**  Expert → System → External memory → Warning at  
Direct access code: 140005-000

**Description** Issues a warning before the data carrier is x% full.  
A warning is indicated on the device and this is also stored in the event buffer.  
A relay can also be switched.

 Only for external SD card (does not apply to USB stick)!

**User entry** 0 to 99%

**Factory setting** 90

---

### Switches relay

---

**Navigation**  Expert → System → External memory → Switches relay  
Direct access code: 140006-000

**Description** When the warning "Data carrier full" is displayed a relay can also be switched on.

**Options** Not used, Relay x  
All the available relays are displayed.

**Factory setting** Not used

---

### CSV settings

---

 Also configurable if "Protected format" is set.

---

### Separator for CSV

---

<b>Navigation</b>	 Expert → System → External memory → Separator for CSV Direct access code: 140002-000
<b>Description</b>	Configure which separator is used by your application (e.g. in Excel = semicolon).
<b>Options</b>	Comma, Semicolon
<b>Factory setting</b>	Semicolon

---

### Date/time

---

<b>Navigation</b>	 Expert → System → External memory → Date/time Direct access code: 140003-000
<b>Description</b>	Please select if the date and time should be stored in one column or separate columns when data is saved in CSV format files
<b>Options</b>	One column, Separate columns
<b>Factory setting</b>	Separate columns

---

### Operational time

---

<b>Navigation</b>	 Expert → System → External memory → Operational time Direct access code: 140004-000
<b>Description</b>	Please select in which format operation times will be stored/displayed.
<b>Options</b>	0 seconds, 0.0000 hours, 0.00000 days, 0000h00:00
<b>Factory setting</b>	0000h00:00

---

### "Messages" submenu

---

<b>Navigation</b>	 Expert → System → Messages
<b>Description</b>	Contains settings for displaying/acknowledging messages. Examples of messages include: messages triggered by limit values; messages triggered by a digital input; error messages; etc.

---

### Acknowledging messages

---

<b>Navigation</b>	 Expert → System → Messages → Acknowledging messages Direct access code: 100040-000
-------------------	---

<b>Description</b>	The time the message is acknowledged can be saved in the events list.
<b>Options</b>	Do not save, Save
<b>Factory setting</b>	Do not save

---

### Switches relay

---

<b>Navigation</b>	 Expert → System → Messages → Switches relay Direct access code: 100042-000
<b>Description</b>	A relay can be switched as soon as a message that has to be confirmed is displayed (e.g. on/off message, device errors etc.). The relay is switched until the message is acknowledged.
<b>Options</b>	Not used, Relay x All the available relays are displayed.
<b>Factory setting</b>	Not used

---

### "Screen saver" submenu



---

<b>Navigation</b>	 Expert → System → Screen saver
<b>Description</b>	To increase the life span of the LCDs the rear illumination can be switched off (= screen saver).

---

### Screen saver

---



<b>Navigation</b>	 Expert → System → Screen saver → Screen saver Direct access code: 160000-000
<b>Description</b>	"Switched off": LCD is always switched on. "Switch on for x min.": display goes dark after x minutes. All other functions remain in operation. Press an operating key: Illumination is switched back on. "Switch daily": Enter time span.
<b>Options</b>	Switched off, On after 10 min., On after 30 min., On after 60 min., Switched daily
<b>Factory setting</b>	Switched off This setting has no effect if the screen saver is controlled by a digital input (→  100).

---

### ON daily from

---



<b>Navigation</b>	 Expert → System → Screen saver → ON daily from Direct access code: 160001-000
<b>Description</b>	Set time (hh:mm) as of when the screensaver should be switched on (e.g. shift end time).  The screen saver is switched off as soon as the device is operated via onsite operation. It switches back on automatically after 1 minute of inactivity. Only visible if screen saver = switched daily
<b>User entry</b>	Time (hh:mm)
<b>Factory setting</b>	20:00

---

**OFF daily from**



---

<b>Navigation</b>	 Expert → System → Screen saver → OFF daily from Direct access code: 160002-000
<b>Description</b>	Set time (hh:mm) as of when the screensaver should be switched off (e.g. shift start time). Only visible if screen saver = switched daily
<b>User entry</b>	Time (hh:mm)
<b>Factory setting</b>	07:00

---

**Screen saver**



---

<b>Navigation</b>	 Expert → System → Screen saver → Screen saver Direct access code: 160003-000
<b>Description</b>	"Off on alarm": In alarm condition (e.g. limit over/under shoot, etc.) the screen saver will be automatically deactivated and the screen will appear. "Always on": Even in alarm condition the recorder will remain in screen saver mode.  Active messages or events involving an error (Fxxx) or "out of specification" (Sxxx) that require acknowledgment will automatically deactivate the screen saver.
<b>Options</b>	Off on alarm, Always on
<b>Factory setting</b>	Off on alarm

---

**"Device options" submenu**



---

<b>Navigation</b>	 Expert → System → Device options
<b>Description</b>	Hardware and software options of the device.

---

**Activation code**



---

<b>Navigation</b>	 Expert → System → Device options → Activation code Direct access code: 000057-000
<b>Description</b>	Here, you can enter a code to enable the device options. Note: When an activation code is entered, the device is restarted in order to enable the new option.  <ul style="list-style-type: none"> <li>▪ The activation code entered is not displayed, i.e. this parameter is always empty following a restart.</li> <li>▪ Pay attention to case-sensitivity.</li> </ul>
<b>User entry</b>	Text

---

**Slot 1**



---

<b>Navigation</b>	 Expert → System → Device options → Slot 1 Direct access code: 990000-000
<b>Description</b>	Hardware and software options. Cannot be edited.  The assignment can be specified in the PC operating software for offline configuration.
<b>Options</b>	Not assigned, Universal inputs
<b>Factory setting</b>	Not assigned

---

**Slot 2**



---

<b>Navigation</b>	 Expert → System → Device options → Slot 2 Direct access code: 990001-000
<b>Description</b>	Hardware and software options. Cannot be edited.  The assignment can be specified in the PC operating software for offline configuration.
<b>Options</b>	Not assigned, Universal inputs
<b>Factory setting</b>	Not assigned

---

**Slot 3**



---

<b>Navigation</b>	 Expert → System → Device options → Slot 3 Direct access code: 990002-000
<b>Description</b>	Hardware and software options. Cannot be edited.  The assignment can be specified in the PC operating software for offline configuration.
<b>Options</b>	Not assigned, Universal inputs
<b>Factory setting</b>	Not assigned

---

### Communication

---

<b>Navigation</b>	 Expert → System → Device options → Communication Direct access code: 990006-000
<b>Description</b>	Hardware and software options.
<b>Options</b>	USB + Ethernet, USB + Ethernet + RS232/485
<b>Factory setting</b>	USB + Ethernet

---

### Fieldbus

---

<b>Navigation</b>	 Expert → System → Device options → Fieldbus Direct access code: 990005-000
<b>Description</b>	Hardware and software options.
<b>Options</b>	Not available, Modbus Slave
<b>Factory setting</b>	Not available

---

### Application

---

<b>Navigation</b>	 Expert → System → Device options → Application Direct access code: 990007-000
<b>Description</b>	Hardware and software options.
<b>Options</b>	Standard, Maths
<b>Factory setting</b>	Standard



## 16.1.2 "Inputs" submenu

Settings for the analog and digital inputs.

---

### Submenu "Universal inputs -> Universal input x"

---

<b>Navigation</b>	 Expert → System → Universal inputs → Universal input x
<b>Description</b>	Settings for the connected measuring points. View or change settings for the selected channel.  x = place holder for selected universal input

---

### Signal

---

<b>Navigation</b>	 Expert → Inputs → Universal inputs → Universal input x → Signal Direct access code: 220000-0xx Examples: Universal input 1: 220000-000; Universal input 12: 220000-011
<b>Description</b>	Select the type of signal connected (current, voltage, etc.). The channel is switched off if no signal type is selected (factory default).
<b>Options</b>	Switched off, Current, Voltage, Resistance temperature detector, Thermocouple, Pulse counter, Frequency input, Modbus Slave (option)
<b>Factory setting</b>	Switched off

---

### Range

---

<b>Navigation</b>	 Expert → Inputs → Universal inputs → Universal input x → Range Direct access code: 220001-0xx Examples: Universal input 1: 220001-000; Universal input 12: 220001-011
<b>Description</b>	Select the input range or which resistance thermometer/thermocouple is connected. The respective terminal layout can be found in the operating manual or on the rear of the unit. Only visible if signal ≠ switched off
<b>Options</b>	Switched off, 4-20 mA, 0-20 mA, 0-5 mA, 0-20 mA squared, 4-20 mA squared, ±20 mA, 0-1 V, 0-10 V, 0-5 V, 1-5 V, ±150 mV, ±1 V, ±10 V, ±30 V, 0-1 V squared, 0-10 V squared, 1-5 V squared, Pt100 (IEC), Pt100 (JIS), Pt100 (GOST), Pt500 (IEC), Pt500 (JIS), Pt1000 (IEC), Pt1000 (JIS), Pt46 (GOST), Pt50 (GOST), Cu50 (GOST, a=4260), Cu50 (GOST, a=4280), Cu53 (GOST, a=4280), Cu100 (GOST, a=4280), Type A (W5Re-W20Re), Type B (Pt30Rh-Pt6Rh), Type C (W5Re-W25Re), Type D (W3Re-W25Re), Type J (Fe-CuNi), Type K (NiCr-Ni), Type L (Fe-CuNi), Type L (Fe-CuNi, GOST), Type N (NiCrSi-NiSi), Type R (Pt13Rh-Pt), Type S (Pt10Rh-Pt), Type T (Cu-CuNi), Frequency input, Modbus
<b>Factory setting</b>	Switched off

---

**Connection**



---

<b>Navigation</b>	 Expert → Inputs → Universal inputs → Universal input x → Connection Direct access code: 220002-0xx Examples: Universal input 1: 220002-000; Universal input 12: 220002-011
<b>Description</b>	Specify whether RTDs are connected as 2-, 3- or 4-wire systems. Only visible if signal = resistance temperature detector
<b>Options</b>	2-wire, 3-wire, 4-wire
<b>Factory setting</b>	4-wire

---

**Channel ident.**



---

<b>Navigation</b>	 Expert → Inputs → Universal inputs → Universal input x → Channel ident. Direct access code: 220003-0xx Examples: Universal input 1: 220003-000; Universal input 12: 220003-011
<b>Description</b>	Name of the measuring point connected to this input. Only visible if signal ≠ switched off
<b>User entry</b>	Text (16 characters)
<b>Factory setting</b>	Channel x

---

**Engineering unit**



---

<b>Navigation</b>	 Expert → Inputs → Universal inputs → Universal input x → Engineering unit Direct access code: 220004-0xx Examples: Universal input 1: 220004-000; Universal input 12: 220004-011
<b>Description</b>	Specify the technical (physical) unit for the measuring point connected to this input. Only visible if signal ≠ switched off
<b>User entry</b>	Text (6 characters)

---

**Plot type**

---

<b>Navigation</b>	 Expert → Inputs → Universal inputs → Universal input x → Plot type Direct access code: 220016-0xx Examples: Universal input 1: 220016-000; Universal input 12: 220016-011
-------------------	---

<b>Description</b>	The analog inputs are scanned in a 100ms cycle. Dependent on the store cycle the selected data is selected and stored from the scanned values. Only visible if signal = current, voltage, resistance temperature detector, thermocouple, frequency input or Modbus Slave (option)
<b>Options</b>	Instantaneous value, Average, Minimum value, Maximum value, Minimum + Maximum
<b>Factory setting</b>	Average

---

### Pulse counter

---

<b>Navigation</b>	 Expert → Inputs → Universal inputs → Universal input x → Pulse counter Direct access code: 220017-0xx Examples: Universal input 1: 220017-000; Universal input 12: 220017-011
<b>Description</b>	Please check if the pulse counter used is a fast or slow (up to a max. 25 Hz) counter. For example if the number of state changes from a relay are to be monitored then you must set up "up to 25Hz". Only visible if signal = pulse counter
<b>Options</b>	Up to 13kHz, Up to 25Hz
<b>Factory setting</b>	Up to 13kHz

---

### Pulse value

---

<b>Navigation</b>	 Expert → Inputs → Universal inputs → Universal input x → Pulse value Direct access code: 220010-0xx Examples: Universal input 1: 220010-000; Universal input 12: 220010-011
<b>Description</b>	Factor, that when multiplied by the input signal results in the required physical value. Example: 1 pulse equals 5 m <sup>3</sup> -> enter "5". Only visible if signal = pulse counter
<b>User entry</b>	Number, max. 8 digits
<b>Factory setting</b>	1

---

### Decimal point

---

<b>Navigation</b>	 Expert → Inputs → Universal inputs → Universal input x → Decimal point Direct access code: 220005-0xx Examples: Universal input 1: 220005-000; Universal input 12: 220005-011
<b>Description</b>	Number of places after decimal point for the display. Only visible if signal ≠ switched off

<b>Options</b>	None, One (X.Y), Two (X.YY), Three (X.YYY), Four (X.YYYY), Five (X.YYYYY)
<b>Factory setting</b>	One (X.Y)

---

### Lower frequency



---

<b>Navigation</b>	 Expert → Inputs → Universal inputs → Universal input x → Lower frequency Direct access code: 220018-0xx Examples: Universal input 1: 220018-000; Universal input 12: 220018-011
<b>Description</b>	Configure the lower frequency that corresponds to the start of the measuring range. Only visible if signal = frequency input
<b>User entry</b>	Number (max. 8 digits), minimum: 0
<b>Factory setting</b>	5

---

### Range start

---

<b>Navigation</b>	 Expert → Inputs → Universal inputs → Universal input x → Range start Direct access code: 220006-0xx Examples: Universal input 1: 220006-000; Universal input 12: 220006-011
<b>Description</b>	<p>Transmitters convert the physical measured variable to standardized signals. Enter the start of the measuring range here.</p>  <ul style="list-style-type: none"> <li>▪ The start and end of the measuring range may not be identical.</li> <li>▪ The start of the measuring range can also be larger than the end (e.g. for deep wells).</li> <li>▪ The parameter can be defined independently of the number of decimal places configured for the measured value as these are only taken into consideration for the display.</li> </ul>
<b>User entry</b>	Number (max. 8 digits)
<b>Factory setting</b>	Depends on the input signal selected

---

### Upper frequency

---

<b>Navigation</b>	 Expert → Inputs → Universal inputs → Universal input x → Upper frequency Direct access code: 220019-0xx Examples: Universal input 1: 220019-000; Universal input 12: 220019-011
<b>Description</b>	Configure the upper frequency that corresponds to the end of the measuring range. Only visible if signal = frequency input
<b>User entry</b>	Number (max. 8 digits)

**Factory setting** 1000

---

### Meas. range end

---

**Navigation**  Expert → Inputs → Universal inputs → Universal input x → Meas. range end  
Direct access code: 220006-0xx  
Examples: Universal input 1: 220007-000; Universal input 12: 220007-011

**Description** Transmitters convert the physical measured variable to standardized signals. Enter the end of the measuring range here.

-  The start and end of the measuring range may not be identical.
- The end of the measuring range can also be smaller than the start (e.g. for deep wells).
- The parameter can be defined independently of the number of decimal places configured for the measured value as these are only taken into consideration for the display.

**User entry** Number (max. 8 digits)

**Factory setting** Depends on the input signal selected

---

### Zoom start

---

**Navigation**  Expert → Inputs → Universal inputs → Universal input x → Zoom start  
Direct access code: 220011-0xx  
Examples: Universal input 1: 220011-000; Universal input 12: 220011-011

**Description** Transmitters convert the physical measured variable to standardized signals. Enter the start of the zoom range here.

-  The zoom can also be set outside the measuring range. The only restriction is that the start and end of the zoom may not be identical.
- If the signal or the range is changed, the zoom is corrected if it no longer fits the measuring range.
- The zoom start can also be larger than the zoom end. The device will automatically rotate the values on the display.

**User entry** Number (max. 8 digits)

**Factory setting** Depends on the input signal selected

---

### Zoom end

---

**Navigation**  Expert → Inputs → Universal inputs → Universal input x → Zoom end  
Direct access code: 220012-0xx  
Examples: Universal input 1: 220012-000; Universal input 12: 220012-011



<b>Description</b>	Enter the end of the zoom range here.  <ul style="list-style-type: none"> <li>▪ The zoom can also be set outside the measuring range. The only restriction is that the start and end of the zoom may not be identical.</li> <li>▪ If the signal or the range is changed, the zoom is corrected if it no longer fits the measuring range.</li> <li>▪ The zoom end can also be smaller than the zoom start. The device will automatically rotate the values on the display.</li> </ul>
<b>User entry</b>	Number (max. 8 digits)
<b>Factory setting</b>	Depends on the input signal selected

---

### Damping

---

<b>Navigation</b>	 Expert → Inputs → Universal inputs → Universal input x → Damping Direct access code: 220008-0xx Examples: Universal input 1: 220008-000; Universal input 12: 220008-011
<b>Description</b>	Factory default setting: 0.0 s. The more unwanted interference there is on the measurement signal the higher the value that should be entered here. Result: Fast changes will be damped/suppressed. Only visible if signal = current, voltage, resistance temperature detector or thermocouple
<b>User entry</b>	0 to 9999.9 s
<b>Factory setting</b>	0 For resistance temperature detectors and thermocouples: 0.2s

---

### Comparison point

---

<b>Navigation</b>	 Expert → Inputs → Universal inputs → Universal input x → Comparison point Direct access code: 220013-0xx Examples: Universal input 1: 220013-000; Universal input 12: 220013-011
<b>Description</b>	Intern: Compensation of the voltage error by measuring the terminal temperature. Extern: Compensation of the voltage error by using an external controlled comparison measurement point. Only visible if signal = thermocouple
<b>Options</b>	Internal, External
<b>Factory setting</b>	Internal

---

### Comparison temp.

---

<b>Navigation</b>	 Expert → Inputs → Universal inputs → Universal input x → Comparison temp. Direct access code: 220014-0xx Examples: Universal input 1: 220014-000; Universal input 12: 220014-011
<b>Description</b>	Settings for the external comparison temperature (only when connecting thermocouples). Only visible if comparison point = external
<b>User entry</b>	Number (max. 8 digits)
<b>Factory setting</b>	0

---

**Totalizer**



---

<b>Navigation</b>	 Expert → Inputs → Universal inputs → Universal input x → Totalizer Direct access code: 220015-0xx Examples: Universal input 1: 220015-000; Universal input 12: 220015-011
<b>Description</b>	Initial setting for the totalizer. Useful when continuing measurements recorded to date with an (electro)-mechanical counter. Only visible if signal = pulse counter
<b>User entry</b>	Number (max. 15 digits)
<b>Factory setting</b>	0

---

**Copy settings**



---

<b>Navigation</b>	 Expert → Inputs → Universal inputs → Universal input x → Fault mode → Copy settings Direct access code: 220200-0xx Examples: Universal input 1: 220200-000; Universal input 12: 220200-011
<b>Description</b>	Copies settings from actual channel to selected channel.
<b>Options</b>	Switched off, Universal input x Users can choose from all the available universal inputs.
<b>Factory setting</b>	Switched off

---

**"Measured value correction" submenu**

---

<b>Navigation</b>	 Expert → Inputs → Universal inputs → Universal input x → Measured value correction
-------------------	--

**Description** Determining the correction values to balance measurement tolerances.

**Proceed as follows:**

- Measure the current value at the lower measurement range.
- Measure the current value at the upper measurement range.
- Enter the lower and upper target and actual value.

---

### Offset

---

**Navigation**  Expert → Inputs → Universal inputs → Universal input x → Measured value correction → Offset  
Direct access code: 220050-0xx  
Examples: Universal input 1: 220050-000; Universal input 12: 220050-011

**Description** This offset is only effective on the analog input signal (no maths / bus channels). Only visible if signal = resistance thermometer detector or thermocouple

**User entry** Number (max. 8 digits)

**Factory setting** 0

---

### Correction RPT

---

**Navigation**  Expert → Inputs → Universal inputs → Universal input x → Measured value correction → Correction RPT  
Direct access code: 220057-0xx  
Examples: Universal input 1: 220057-000; Universal input 12: 220057-011

**Description** Rear panel temperature correction value for this analog input (only required for thermocouples).

 Only visible/editable if the service code has been entered.

Only visible if signal = resistance thermometer detector or thermocouple

**User entry** Number (max. 8 digits)

**Factory setting** 0

---

### Range start

---



---

### Target value

---

<b>Navigation</b>	 Expert → Inputs → Universal inputs → Universal input x → Measured value correction → Target value Direct access code: 220052-0xx Examples: Universal input 1: 220052-000; Universal input 12: 220052-011
<b>Description</b>	Enter the lower setpoint here (e.g. measuring range 0°C to 100°C: 0°C). Only visible if signal = current or voltage
<b>User entry</b>	Number (max. 8 digits)
<b>Factory setting</b>	0

---

**Actual value**

---

<b>Navigation</b>	 Expert → Inputs → Universal inputs → Universal input x → Measured value correction → Actual value Direct access code: 220053-0xx Examples: Universal input 1: 220053-000; Universal input 12: 220053-011
<b>Description</b>	Enter the lower value actually measured here (e.g. measuring range 0°C to 100°C: measured value 0.5°C). Only visible if signal = current or voltage
<b>User entry</b>	Number (max. 8 digits)
<b>Factory setting</b>	0

---

**Meas. range end**



---



---

**Target value**



---

<b>Navigation</b>	 Expert → Inputs → Universal inputs → Universal input x → Measured value correction → Target value Direct access code: 220055-0xx Examples: Universal input 1: 220055-000; Universal input 12: 220055-011
<b>Description</b>	Enter the upper setpoint here (e.g. measuring range 0°C to 100°C: 100°C). Only visible if signal = current or voltage
<b>User entry</b>	Number (max. 8 digits)
<b>Factory setting</b>	100

---

**Actual value**



---

<b>Navigation</b>	 Expert → Inputs → Universal inputs → Universal input x → Measured value correction → Actual value Direct access code: 220056-0xx Examples: Universal input 1: 220056-000; Universal input 12: 220056-011
<b>Description</b>	Enter the upper value actually measured here (e.g. measuring range 0°C to 100°C: measured value 100.5°C). Only visible if signal = current or voltage
<b>User entry</b>	Number (max. 8 digits)
<b>Factory setting</b>	100

---

### "Totalization" submenu

---

<b>Navigation</b>	 Expert → Inputs → Universal inputs → Universal input x → Totalization
<b>Description</b>	Set up only required for totalization of flow or power consumption.

---

### Totalization

---

<b>Navigation</b>	 Expert → Inputs → Universal inputs → Universal input x → Totalization → Totalization Direct access code: 220030-0xx Examples: Universal input 1: 220030-000; Universal input 12: 220030-011
<b>Description</b>	By totalizing the analog signal (e.g. flow rate in m <sup>3</sup> /h) quantities (in m <sup>3</sup> ) can be calculated.
<b>Options</b>	No, Yes
<b>Factory setting</b>	No

---

### Totalization base

---

<b>Navigation</b>	 Expert → Inputs → Universal inputs → Universal input x → Totalization → Totalization base Direct access code: 220031-0xx Examples: Universal input 1: 220031-000; Universal input 12: 220031-011
<b>Description</b>	Select the required time base. Example: ml/s → time base seconds (s); m <sup>3</sup> /h → time base hours (h). Only visible if totalization = yes
<b>Options</b>	Second (s), Minute (min), Hour (h), Day (d)
<b>Factory setting</b>	Second (s)

---

**Unit**



---

<b>Navigation</b>	 Expert → Inputs → Universal inputs → Universal input x → Totalization → Unit Direct access code: 220032-0xx Examples: Universal input 1: 220032-000; Universal input 12: 220032-011
<b>Description</b>	Enter the unit for the calculated quantity (e.g. "m <sup>3</sup> "). Only visible if totalization = yes
<b>User entry</b>	Text (max. 6 characters)

---

**Low flow cut off**



---

<b>Navigation</b>	 Expert → Inputs → Universal inputs → Universal input x → Totalization → Low flow cut off Direct access code: 220033-0xx Examples: Universal input 1: 220033-000; Universal input 12: 220033-011
<b>Description</b>	If the volume flow recorded is below the set value, these quantities are not added to the counter. If the input is scaled from 0 to y, or if the pulse input is used, all values that are smaller than the set value are not recorded. If the input is scaled from -x to +y, all values around the zero point (e.g. also negative values) are not recorded. Only visible if totalization = yes
<b>User entry</b>	Number (max. 8 digits)
<b>Factory setting</b>	0

---

**Calc. factor**



---

<b>Navigation</b>	 Expert → Inputs → Universal inputs → Universal input x → Totalization → Calc. factor Direct access code: 220034-0xx Examples: Universal input 1: 220034-000; Universal input 12: 220034-011
<b>Description</b>	Factor for calculating the integrated value (e.g. the transmitter delivers l/s → totalization base = second → engineering unit required is m <sup>3</sup> → enter factor 0.001) Only visible if totalization = yes
<b>User entry</b>	Number (max. 8 digits)
<b>Factory setting</b>	1.0

---

**Totalizer**





---

<b>Navigation</b>	 Expert → Inputs → Universal inputs → Universal input x → Totalization → Totalizer Direct access code: 220035-0xx Examples: Universal input 1: 220035-000; Universal input 12: 220035-011
<b>Description</b>	Initial setting for the totalizer. Useful when continuing measurements recorded to date with an (electro)-mechanical counter. Only visible if totalization = yes
<b>User entry</b>	Number (max. 15 digits)
<b>Factory setting</b>	0

---

**"Fault mode" submenu**



---

	 In the event of an error the alarm relay is switched if so configured (→  68)
<b>Navigation</b>	 Expert → Inputs → Universal inputs → Universal input x → Fault mode
<b>Description</b>	Contains settings that define how this channel is to react under fault conditions (e.g. cable open circuit, over range).

---

**NAMUR NE 43**



---

<b>Navigation</b>	 Expert → Inputs → Universal inputs → Universal input x → Fault mode → NAMUR NE 43 Direct access code: 220060-0xx Examples: Universal input 1: 220060-000; Universal input 12: 220060-011
<b>Description</b>	Activate/deactivate the 4-20mA loop monitoring as per NAMUR recommendation NE 43. The following error ranges apply when NAMUR NE43 is switched on: ≤ 3.8 mA: under range ≥ 20.5 mA: over range ≤ 3.6 mA or ≥ 21.0 mA: sensor error ≤ 2 mA: cable open circuit
<b>Options</b>	Off, On
<b>Factory setting</b>	On

---

**Cable open circuit detection**

---

<b>Navigation</b>	 Expert → Inputs → Universal inputs → Universal input x → Fault mode → Cable open circuit detection Direct access code: 220060-0xx Examples: Universal input 1: 220060-000; Universal input 12: 220060-011
-------------------	---

<b>Description</b>	Cable open circuit detection Only visible if signal = voltage and range = 1-5V or 1-5V squared.
<b>Options</b>	Off, On
<b>Factory setting</b>	On

---

#### Lower error value

---

<b>Navigation</b>	 Expert → Inputs → Universal inputs → Universal input x → Fault mode → Lower error value Direct access code: 220065-0xx Examples: Universal input 1: 220065-000; Universal input 12: 220065-011
<b>Description</b>	When NE 43 is switched off, defines the value that must be undershot for the device to output an error. Only visible if signal = current, range = 4 to 20mA and NAMUR NE 43 = off
<b>User entry</b>	Number (max. 8 digits); 0 to 4
<b>Factory setting</b>	3.9

---

#### Upper error value

---

<b>Navigation</b>	 Expert → Inputs → Universal inputs → Universal input x → Fault mode → Upper error value Direct access code: 220066-0xx Examples: Universal input 1: 220066-000; Universal input 12: 220066-011
<b>Description</b>	When NE 43 is switched off, defines the value that must be exceeded for the device to output an error. Only visible if signal = current, range = 4 to 20mA and NAMUR NE 43 = off
<b>User entry</b>	Number (max. 8 digits); 20 to 22
<b>Factory setting</b>	20.8

---

#### On error

---

<b>Navigation</b>	 Expert → Inputs → Universal inputs → Universal input x → Fault mode → On error Direct access code: 220061-0xx Examples: Universal input 1: 220061-000; Universal input 12: 220061-011
-------------------	---



<b>Description</b>	Configure what value the device should continue working with (for calculations) if the measured value is not valid (e.g. cable open circuit).  In the event of an error value, all the dependent calculations are flagged accordingly as "error value". Counters are not flagged, however!
<b>Options</b>	Invalid calculation, Error value
<b>Factory setting</b>	Invalid calculation

---

#### Error value

---

<b>Navigation</b>	 Expert → Inputs → Universal inputs → Universal input x → Fault mode → Error value Direct access code: 220062-0xx Examples: Universal input 1: 220062-000; Universal input 12: 220062-011
<b>Description</b>	The device continues calculating with this value in the event of an error. Only visible if on error = error value
<b>User entry</b>	Number (max. 8 digits)
<b>Factory setting</b>	0

---

#### Save event



---

<b>Navigation</b>	 Expert → Inputs → Universal inputs → Universal input x → Fault mode → Save event Direct access code: 220063-0xx Examples: Universal input 1: 220063-000; Universal input 12: 220063-011
<b>Description</b>	Stores a message in the event log when a fault occurs.
<b>Options</b>	No, Yes
<b>Factory setting</b>	No

---

#### Submenu "Digital inputs -> Digital input x"

---

<b>Navigation</b>	 Expert → Inputs → Digital inputs → Digital input x
<b>Description</b>	Setting up only required if the digital inputs (e.g. events) are to be used.  x = place holder for selected digital input

---

#### Function

---

<b>Navigation</b>	 Expert → Inputs → Digital inputs → Digital input x → Function Direct access code: 250000-00x Examples: Digital input 1: 250000-000; Digital input 6: 250000-005
<b>Description</b>	Select the required function: Digital inputs are High active; this means the described effect is achieved by a high input. Low = -3...+5V High = +12...+30V
<b>Options</b>	Switched off, Control input, On/off event, Pulse counter, Operational time, Event +operation time, Quantity from time, Modbus Slave (option)
<b>Factory setting</b>	Switched off

---

### Function

---

<b>Navigation</b>	 Expert → Inputs → Digital inputs → Digital input x → Function Direct access code: 250014-00x Examples: Digital input 1: 250014-000; Digital input 6: 250014-005
<b>Description</b>	Specifies how the data are interpreted/processed by the fieldbus. Only visible if function = Modbus Slave
<b>Options</b>	Switched off, Control input, On/off event, Pulse counter, Operational time, Event +operation time, Quantity from time, Modbus Slave
<b>Factory setting</b>	Switched off

---

### Channel ident.

---

<b>Navigation</b>	 Expert → Inputs → Digital inputs → Digital input x → Channel ident. Direct access code: 250001-00x Examples: Digital input 1: 250001-000; Digital input 6: 250001-005
<b>Description</b>	Measurement point name (e.g. "Pump") or description of the function of this input (e.g. "Fault message"). Only visible if function ≠ switched off
<b>User entry</b>	Text (max. 16 characters)
<b>Factory setting</b>	Digital x

---

### Engineering unit

---

<b>Navigation</b>	 Expert → Inputs → Digital inputs → Digital input x → Engineering unit Direct access code: 250002-00x Examples: Digital input 1: 250002-000; Digital input 6: 250002-005
<b>Description</b>	Technical units of the count input, e.g. gal, cf ... Only visible if function = pulse counter or quantity from time
<b>User entry</b>	Text (max. 6 characters)

---

### Decimal point

---

<b>Navigation</b>	 Expert → Inputs → Digital inputs → Digital input x → Decimal point Direct access code: 250004-00x Examples: Digital input 1: 250004-000; Digital input 6: 250004-005
<b>Description</b>	Number of places after decimal point for the display. Only visible if function = pulse counter or quantity from time
<b>Options</b>	None, One (X.Y), Two (X.YY), Three (X.YYY), Four (X.YYYY), Five (X.YYYYY)
<b>Factory setting</b>	One (X.Y)

---

### Input factor in

---

<b>Navigation</b>	 Expert → Inputs → Digital inputs → Digital input x → Input factor in Direct access code: 250004-00x Examples: Digital input 1: 250004-000; Digital input 6: 250004-005
<b>Description</b>	Defines if the set up factor is respective to 1 second or 1 hour. Only visible if function = quantity from time
<b>Options</b>	Seconds, hours
<b>Factory setting</b>	Seconds

---

### Pulse value

---

<b>Navigation</b>	 Expert → Inputs → Digital inputs → Digital input x → Pulse value Direct access code: 250005-00x Examples: Digital input 1: 250005-000; Digital input 6: 250005-005
<b>Description</b>	Factor, that when multiplied by the input signal results in the required physical value. Examples: 1 pulse equals 5 m <sup>3</sup> -> enter "5". Only visible if function = pulse counter

**User entry** Number (max. 8 digits)

**Factory setting** 1

---

**1 second= / 1 hour=** (depends on the setting in "Input factor in")

---

**Navigation**  Expert → Inputs → Digital inputs → Digital input x → 1 second= / 1 hour=  
Direct access code: 250005-00x  
Examples: Digital input 1: 250005-000; Digital input 6: 250005-005

**Description** Factor, that when multiplied by the operating time results in the required physical value.  
Examples:  
1 second equals 8 l → enter "8".  
Only visible if function = quantity from time

**User entry** Number (max. 8 digits)

**Factory setting** 1

---

### Time delay

---

**Navigation**  Expert → Inputs → Digital inputs → Digital input x → Time delay  
Direct access code: 250017-00x  
Examples: Digital input 1: 250017-000; Digital input 6: 250017-005

**Description** The high signal must be active for at least the preset time before the device changes the channel from low to high.  
The change from high to low is always immediate.  
Only visible if function = control input, on/off event, event+operation time

**User entry** 0 to 99 999 s

**Factory setting** 0

---

### Action

---

**Navigation**  Expert → Inputs → Digital inputs → Digital input x → Action  
Direct access code: 250003-00x  
Examples: Digital input 1: 250003-000; Digital input 6: 250003-005

**Description** Set up the function of the control input.  
Only visible if function = control input

Function	Description
Start/stop recording	The device only saves data as long as a high signal is present
Screen saver on	Switches backlighting/display off, low = off, high = on
Block set up	The user can only change the setup if a low signal is present
Time synchronization	If a high signal is applied, the device rounds the system time up or down (only for low→high change) to the nearest minute: 0 to 29→ round down; 30 to 59→ round up
Block keyboard/navigator	The device can only be operated if a low signal is present. Otherwise all key activation and navigator actions are discarded.
Set point monitoring on/off	The entire set point monitoring function of the device can be switched on (for "high") or switched off (for "low").
Start/stop analysis 1	Starts/ends the external analyses (the analysis only runs as long as the signal is high). Measured value recording for the graphic display continues.

**Options** Switched off, Start recording, Screensaver on, Block set up, Time synchronization, Set point monitoring on/off, Block keyboard/navigator, Start/stop analysis 1

**Factory setting** Switched off

---

### Switches relay

---

**Navigation**  Expert → Inputs → Digital inputs → Digital input x → Switches relay  
Direct access code: 250006-00x  
Examples: Digital input 1: 250006-000; Digital input 6: 250006-005

**Description** Switches the respective relay when the digital input is low or high. Please take note of the connection hints in the operating manual!  
Only visible if function = control input, on/off event, event+operation time

**Options** Not used, Relay x  
All the available relays are displayed.

**Factory setting** Not used

---

### Description 'H'

---

**Navigation**  Expert → Inputs → Digital inputs → Digital input x → Description 'H'  
Direct access code: 250007-00x  
Examples: Digital input 1: 250007-000; Digital input 6: 250007-005

**Description** Condition description when the digital input is active. This text is both shown in the display and saved to memory.  
Only visible if function = control input, on/off event, event+operation time

**User entry** Text (max. 6 characters)

**Factory setting** On

---

**Description 'L'**



---

<b>Navigation</b>	 Expert → Inputs → Digital inputs → Digital input x → Description 'L' Direct access code: 250007-00x Examples: Digital input 1: 250007-000; Digital input 6: 250007-005
<b>Description</b>	Condition description when the digital input is not active. This text is both shown in the display and saved to memory. Only visible if function = control input, on/off event, event+operation time
<b>User entry</b>	Text (max. 6 characters)
<b>Factory setting</b>	Off

---

**Save event**



---

<b>Navigation</b>	 Expert → Inputs → Digital inputs → Digital input x → Save event Direct access code: 250009-00x Examples: Digital input 1: 250009-000; Digital input 6: 250009-005
<b>Description</b>	Determines whether the condition change from low to high or high to low is stored in the event log.  Requires higher memory capacity. Only visible if function = control input, on/off event, event+operation time
<b>Options</b>	No, Yes
<b>Factory setting</b>	Yes

---

**Event message**



---

<b>Navigation</b>	 Expert → Inputs → Digital inputs → Digital input x → Event message Direct access code: 250018-00x Examples: Digital input 1: 250018-000; Digital input 6: 250018-005
<b>Description</b>	"Do not acknowledge": No message is shown if the digital input switches. "Acknowledge": A message window is shown on the screen which has to be acknowledged by operating a push button. Only visible if function = control input, on/off event, event+operation time
<b>Options</b>	Do not acknowledge, Acknowledge
<b>Factory setting</b>	Do not acknowledge

---

**Event text L->H**



---

<b>Navigation</b>	 Expert → Inputs → Digital inputs → Digital input x → Event text L->H Direct access code: 250010-00x Examples: Digital input 1: 250010-000; Digital input 6: 250010-005
<b>Description</b>	Description of condition change from low to high. Event text is stored (e.g. Start filling).  If no event text is set, the device generates an automatic event text (factory setting), e.g. digital 1 L->H. Only visible if function = control input, on/off event, event+operation time
<b>User entry</b>	Text (max. 22 characters)

---

**Event text H->L**



---

<b>Navigation</b>	 Expert → Inputs → Digital inputs → Digital input x → Event text H->L Direct access code: 250011-00x Examples: Digital input 1: 250011-000; Digital input 6: 250011-005
<b>Description</b>	Description of condition change from high to low. Event text is stored (e.g. Stop filling).  If no event text is set, the device generates an automatic event text (factory setting), e.g. digital 1 H->L. Only visible if function = control input, on/off event, event+operation time
<b>User entry</b>	Text (max. 22 characters)

---

**Record duration**



---

<b>Navigation</b>	 Expert → Inputs → Digital inputs → Digital input x → Record duration Direct access code: 250012-00x Examples: Digital input 1: 250012-000; Digital input 6: 250012-005
<b>Description</b>	The duration between "On" and "Off" can be recorded. The duration is appended to the "Off" event text (<hhhh>h<mm>:<ss>). Power outage times do not affect the duration. If the digital channel was "on" before the power outage and is still "on" after the power outage, the duration continues. Only visible if function = control input, on/off event, event+operation time
<b>Options</b>	No, Yes
<b>Factory setting</b>	No

---

**Totalizer**



---

<b>Navigation</b>	 Expert → Inputs → Digital inputs → Digital input x → Totalizer Direct access code: 250013-00x Examples: Digital input 1: 250013-000; Digital input 6: 250013-005
<b>Description</b>	Initial setting for the totalizer. Useful when continuing measurements recorded to date with an (electro)-mechanical counter. Only visible if function = pulse counter, operational time, event+operation time or quantity from time
<b>User entry</b>	Number (max. 15 digits)
<b>Factory setting</b>	0

---

### Copy settings

---

<b>Navigation</b>	 Expert → Inputs → Digital inputs → Digital input x → Copy settings Direct access code: 250200-00x Examples: Digital input 1: 250200-000; Digital input 6: 250200-005
<b>Description</b>	Copies settings from actual channel to selected channel.
<b>Options</b>	No, Digital input x Users can choose from all the available digital inputs.
<b>Factory setting</b>	No



### 16.1.3 "Outputs" submenu

Setting up only required if outputs (e.g. relays) are to be used.

---

### "Relay x" submenu

---

<b>Navigation</b>	 Expert → Outputs → Relay x
<b>Description</b>	Contains setup for the selected relay  x = place holder for selected relay

---

### Operating mode

---

<b>Navigation</b>	 Expert → Outputs → Relay x → Operating mode Direct access code: 330000-00x Examples: Relay 1:330000-000; Relay 6: 330000-005
<b>Description</b>	Relay function: NC contact: The relay is closed in its quiescent state (maximum safety). NO contact: The relay is open in its quiescent state.



<b>Options</b>	Closing, Opening
<b>Factory setting</b>	Closing

---

## Identifier

---

<b>Navigation</b>	 Expert → Outputs → Relay x → Identifier Direct access code: 330001-00x Examples: Relay 1:330001-000; Relay 6: 330001-005
<b>Description</b>	Presetable relay identifier.
<b>User entry</b>	Text (max. 16 characters)
<b>Factory setting</b>	Relay x

### 16.1.4 "Communication" submenu

Set-up required if you are using the USB, RS232, RS485 or Ethernet interface of the unit (PC operation, serial data read-out, modem operation, etc.).

 The various interfaces can be operated in parallel.

---

## Timeout

---

<b>Navigation</b>	 Expert → Communication → Timeout Direct access code: 150200-000
<b>Description</b>	The device monitors whether measured values are read out via the OPC server or the fieldbus (e.g. Modbus Slave). A relay can be switched if no more values are read out over the set timeout period. Timeout is modifiable between 1 and 99 seconds. 0 seconds means that the functionality is inactivated.
<b>User entry</b>	0 to 99
<b>Factory setting</b>	0

---

## Switches

---

<b>Navigation</b>	 Expert → Communication → Switches Direct access code: 150201-000
<b>Description</b>	After the given timeout the dedicated relay/OC is active while no readout of actual measured values are in process.

**Options** Not used, Relay x  
All the available relays are displayed.

**Factory setting** Not used

---

### "Ethernet" submenu

---

**Navigation**  Expert → Communication → Ethernet

**Description** Contains the set-up required if you are using the Ethernet interface of the unit.

---

### MAC-Address

---

**Navigation**  Expert → Communication → Ethernet → MAC address  
Direct access code: 150000-000

**Description** Displays the MAC address

---

### DHCP

---

**Navigation**  Expert → Communication → Ethernet → DHCP  
Direct access code: 150002-000

**Description** The device can get its Ethernet settings through DHCP.  
Caution: The settings determined are not displayed until after setup acceptance!

 **Note:** The unit always gets the same IP address if the leasing time is set long enough on the DHCP server. The PC software needs the IP address determined to establish a connection!

**Options** No, Yes

**Factory setting** Yes

---

### IP address

---

**Navigation**  Expert → Communication → Ethernet → IP address  
Direct access code: 150003-000

**Description** Please enter the IP-address (given from your network administrator). Please talk to your network administrator about this.  
Only editable if DHCP = no

**User entry** IP address

**Factory setting** 000.000.000.000

---

### Subnetmask

---

**Navigation**  Expert → Communication → Ethernet → Subnetmask  
Direct access code: 150004-000

**Description** Please enter the subnetmask (given from your network administrator).  
Only editable if DHCP = no

**User entry** IP address

**Factory setting** 255.255.255.000

---

### Gateway

---

**Navigation**  Expert → Communication → Ethernet → Gateway  
Direct access code: 150005-000

**Description** Please enter the Gateway (given from your network administrator).  
Only editable if DHCP = no

**User entry** IP address

**Factory setting** 000.000.000.000

---

### Domain Name System

---

**Navigation**  Expert → Communication → Ethernet → Domain Name System  
Direct access code: 150009-000

**Description** Please enter the IP-address of the DNS server (you can get this from your network administrator).  
Is needed if you wish to send emails and want to use the Email servers name instead of the IP-address (e.g. smtp.example.org).  
Only editable if DHCP = no

**User entry** IP address

**Factory setting** 000.000.000.000

---

### Disable port

---

**Navigation**  Expert → Communication → Ethernet → Disable port  
Direct access code: 150020-000

**Description** You can disable unused ports for security reasons.

 All the other ports (e.g. NTP, SMTP, Web server) are switched off automatically if the function is disabled.

**Options** CDI, OPC, Modbus Slave

**Factory setting** ---- (no port disabled)

---

### Port

---

**Navigation**  Expert → Communication → Ethernet → Port  
Direct access code: 150001-000

**Description** The system communicates with the PC software through this communication port.

 If your network is protected by a firewall, this port may have to be enabled. Please contact your network administrator if this is the case.

**User entry** Number (max. 5 digits)

**Factory setting** 8000

---

### OPC port

---

**Navigation**  Expert → Communication → Ethernet → OPC port  
Direct access code: 150010-000

**Description** Values can be read via OPC server using this communication port.

 If your network is protected by a firewall, this port may have to be enabled. Please contact your network administrator if this is the case.

**User entry** Number (max. 5 digits)

**Factory setting** 8002

---

### Web server

---



**Navigation**  Expert → Communication → Ethernet → Web server  
Direct access code: 470000-000

<b>Description</b>	Switch the web server function on or off (= factory default). The instantaneous values can only be displayed using an Internet browser when the web browser is activated.  Only possible using the Ethernet interface!
<b>Options</b>	No, Yes
<b>Factory setting</b>	Yes

---

### "Configuration Web server" submenu



---

<b>Navigation</b>	 Expert → Communication → Ethernet → Configuration Web server
<b>Description</b>	Configure the Web server or specify which functionality should be possible via Web server. Only visible if Web server = yes.  Instantaneous value display is always possible once the Web server is switched on.

---

### Port

---

<b>Navigation</b>	 Expert → Communication → Ethernet → Configuration Web server → Port Direct access code: 470003-000
<b>Description</b>	The webservice communicates through this communication port.  If your network is protected by a firewall, this port may have to be enabled. Please contact your network administrator if this is the case.
<b>User entry</b>	Number (max. 5 digits)
<b>Factory setting</b>	80

---

### Setup

---

<b>Navigation</b>	 Expert → Communication → Ethernet → Configuration Web server → Setup Direct access code: 470001-000
<b>Description</b>	The device can be configured via Web server. For security reasons it is advisable to switch off configuration via the Web server after commissioning. With regard to IT security please contact your network administrator if necessary.
<b>Options</b>	No, Yes
<b>Factory setting</b>	Yes

**"Authentication" submenu**

**Navigation**  Expert → Communication → Ethernet → Configuration Web server → Authentication

**Description** Set the passwords for the various users with which the device can be accessed via web server.

	Operator	Administrator	Service
Measured value display	Yes	Yes	Yes
Display instrument health status	Yes	Yes	Yes
Configuration	No	Yes	Yes
Configuration incl. service parameter	No	No	Yes
Update firmware	No	Yes	Yes

**Operator****ID**

**Navigation**  Expert → Communication → Ethernet → Configuration Web server → Authentication → ID  
Direct access code: 470104-000

**Description** ID, which is necessary to access the web server.  
Cannot be edited.

**Factory setting** operator

**Password**

**Navigation**  Expert → Communication → Ethernet → Configuration Web server → Authentication → Password  
Direct access code: 470105-000

**Description** Enter a password for this user account.  
Pay attention to case-sensitivity.

**User entry** Text (max. 12 characters)

**Factory setting** operator

**Administrator**

---

**ID**

---

**Navigation**  Expert → Communication → Ethernet → Configuration Web server → Authentication → ID  
Direct access code: 470101-000

**Description** ID, which is necessary to access the web server.  
Cannot be edited.

**Factory setting** admin

---

**Password**

---

**Navigation**  Expert → Communication → Ethernet → Configuration Web server → Authentication → Password  
Direct access code: 470102-000

**Description** Enter a password for this user account.  
Pay attention to case-sensitivity.

**User entry** Text (max. 12 characters)

**Factory setting** admin

---

**Service**



---



---

**ID**

---

**Navigation**  Expert → Communication → Ethernet → Configuration Web server → Authentication → ID  
Direct access code: 470107-000

**Description** ID, which is necessary to access the web server.  
Cannot be edited.

**Factory setting** service

---

**Password**



---

<b>Navigation</b>	 Expert → Communication → Ethernet → Configuration Web server → Authentication → Password Direct access code: 470108-000
<b>Description</b>	Enter a password for this user account. Pay attention to case-sensitivity.
<b>User entry</b>	Text (max. 12 characters)
<b>Factory setting</b>	service

---

### "Serial interface" submenu

---

<b>Navigation</b>	 Expert → Communication → Serial interface
<b>Description</b>	Contains the set-up required if you are using the RS232 or RS485 unit interface.

---

### Type

---

<b>Navigation</b>	 Expert → Communication → Serial interface → Type Direct access code: 150100-000
<b>Description</b>	Configure how the serial interface is used. Pay attention to the connections.
<b>Options</b>	RS232, RS485, Debug (only for service purposes)
<b>Factory setting</b>	RS232

---

### Protocol

---

<b>Navigation</b>	 Expert → Communication → Serial interface → Protocol Direct access code: 150105-000
<b>Description</b>	Define the serial interface protocol. Note: The device automatically disables incompatible settings.
<b>Options</b>	PC software, Modbus Slave (only if type = RS485)
<b>Factory setting</b>	PC software

---

### Baudrate

---

<b>Navigation</b>	 Expert → Communication → Serial interface → Baudrate Direct access code: 150101-000
-------------------	--



---

<b>Description</b>	Transmission speed ("Baudrate") - must be the same as the settings for the PC software.
<b>Options</b>	9600, 19200, 38400, 57600, 115200
<b>Factory setting</b>	19200

---

### Parity

---

<b>Navigation</b>	 Expert → Communication → Serial interface → Parity Direct access code: 150103-000
<b>Description</b>	Parity Only visible if protocol ≠ PC software
<b>Options</b>	None, Even, Odd
<b>Factory setting</b>	None

---

### Unit address

---

<b>Navigation</b>	 Expert → Communication → Serial interface → Unit address Direct access code: 150102-000
<b>Description</b>	Every unit operating using RS232/RS485 must have an individual address (00-99). Only visible if type = RS485
<b>User entry</b>	0 to 30
<b>Factory setting</b>	0

---

### "Modbus Slave" submenu (option)

---

<b>Navigation</b>	 Expert → Communication → Modbus Slave
<b>Description</b>	Configure the Modbus settings for the device.

---

### Modbus

---

<b>Navigation</b>	 Expert → Communication → Modbus Slave → Modbus Direct access code: 480000-000
<b>Description</b>	Specify the physical interface you wish to use.
<b>Options</b>	Not used, RS485, Ethernet

**Factory setting** Not used

---

### Unit address

---

**Navigation**  Expert → Communication → Modbus Slave → Unit address  
Direct access code: 480001-000

**Description** Enter the device address where it should be possible to reach this device in the bus.  
Only visible if Modbus = RS485

**User entry** 1 to 247

**Factory setting** 1

---

### Port

---

**Navigation**  Expert → Communication → Modbus Slave → Port  
Direct access code: 480004-000

**Description** Port via which the Modbus protocol can be activated.  
Only visible if Modbus = Ethernet

**User entry** Number (max. 5 digits)

**Factory setting** 502

---

### Timeout

---

**Navigation**  Expert → Communication → Modbus Slave → Timeout  
Direct access code: 150210-000

**Description** Time within which measured values must be received via fieldbus (otherwise an error will be set). Not relevant if only measured values are read out.

**User entry** 1 to 99

**Factory setting** 10

---

### "Serial interface" submenu

---



**Navigation**  Expert → Communication → Modbus Slave → Serial interface

<b>Description</b>	Contains settings for the serial interface. Only visible if Modbus = RS485
<b>Baudrate</b>	
<b>Navigation</b>	 Expert → Communication → Modbus Slave → Serial interface → Baudrate Direct access code: 150101-000
<b>Description</b>	Transmission speed ("Baudrate") - must be the same as the settings for the PC software. Only visible if Modbus = RS485
<b>Options</b>	9600, 19200, 38400, 57600, 115200
<b>Factory setting</b>	19200

<b>Parity</b>	
<b>Navigation</b>	 Expert → Communication → Modbus Slave → Serial interface → Parity Direct access code: 150103-000
<b>Description</b>	Parity Only visible if Modbus = RS485
<b>Options</b>	None, Even, Odd
<b>Factory setting</b>	None

### 16.1.5 "Application" submenu

Configure various application-specific settings (e.g. group settings, limit values, etc.).

<b>Submenu "Maths - Maths x"</b>	
<b>Navigation</b>	 Expert → Application → Maths → Maths x
<b>Description</b>	Configuration of the mathematics channels.  x = place holder for selected mathematics channel
<b>Function</b>	
<b>Navigation</b>	 Expert → Application → Maths → Maths x → Function Direct access code: 400000-000 Examples: Maths 1: 400000-000; Maths 4: 400000-003

**Description** Switch the mathematics channel on or off.

**Options** Switched off, Formula editor

**Factory setting** Switched off

---

## Formula

---

**Navigation**  Expert → Application → Maths → Maths x → Formula  
Direct access code: 400002-000  
Examples: Maths 1: 400002-000; Maths 4: 400002-003

**Description** Enter the desired calculation formula.  
The formula can be any combination of arithmetic calculations and logical operations.  
Analog, digital or already active mathematics channels can be used.  
Please observe the instructions in the Operating Instructions.  
Description of formula editor (→  122)  
Only visible if function = formula editor

**User entry** Formula

---

## The result is

---

**Navigation**  Expert → Application → Maths → Maths x → The result is  
Direct access code: 400003-000  
Examples: Maths 1: 400003-000; Maths 4: 400003-003

**Description** Configure what data type the calculation returns. This setting affects how the channel saves and is displayed.  
If you add 2 analog channels, for example, the result is a "current value".  
From status: the status values of multiple inputs are added. If the result of the calculation is not equal to 0, the operational time is increased every 100 ms by 0.1 s.  
From counter/total: the operational times or counters of x inputs should be added together. The result is the operating time/the sum of the counters of all the inputs.  
Only visible if function = formula editor

**Options** Instantaneous value, State, Counter, Operating time from status, Operating time from total, Control input

**Factory setting** Instantaneous value

---

## Plot type

---

**Navigation**  Expert → Application → Maths → Maths x → Plot type  
Direct access code: 400003-000  
Examples: Maths 1: 400003-000; Maths 4: 400003-003

<b>Description</b>	The mathematics channels are recalculated every 100 ms. Depending on the save cycle, the selected data are determined/saved from the calculated values.
<b>Options</b>	Instantaneous value, Average, Minimum value, Maximum value, Minimum + Maximum
<b>Factory setting</b>	Average

---

### Engineering unit

---

<b>Navigation</b>	 Expert → Application → Maths → Maths x → Engineering unit Direct access code: 400004-000 Examples: Maths 1: 400004-000; Maths 4: 400004-003
<b>Description</b>	Unit of the calculated value Only visible if the result is = instantaneous value or counter
<b>User entry</b>	Text (max. 6 characters)

---

### Decimal point

---

<b>Navigation</b>	 Expert → Application → Maths → Maths x → Decimal point Direct access code: 400005-000 Examples: Maths 1: 400005-000; Maths 4: 400005-003
<b>Description</b>	Number of places after decimal point for the display. Only visible if function = formula editor and the result is = instantaneous value or counter
<b>Options</b>	None, One (X.Y), Two (X.YY), Three (X.YYY), Four (X.YYYY), Five (X.YYYYY)
<b>Factory setting</b>	One (X.Y)

---

### Action

---

<b>Navigation</b>	 Expert → Application → Maths → Maths x → Action Direct access code: 400006-000 Examples: Maths 1: 400006-000; Maths 4: 400006-003
<b>Description</b>	Set up the function of the control input. Only visible if the result is = control input

Function	Description
Start/stop recording	The device only saves data as long as a high signal is present
Set point monitoring on/off	The entire set point monitoring function of the device can be switched on (for "high") or switched off (for "low").
Start/stop analysis 1	Starts/ends the external analyses (the analysis only runs as long as the signal is high). Measured value recording for the graphic display continues.

**Options** Switched off, Start recording, Set point monitoring on/off, Start/stop analysis 1

**Factory setting** Switched off

---

### Switches relay

---

**Navigation**  Expert → Application → Maths → Maths x → Switches relay  
 Direct access code: 400007-000  
 Examples: Maths 1: 400007-000; Maths 4: 400007-003

**Description** Switches the respective relay when the digital input is low or high.  
 Please take note of the connection hints in the operating manual!  
 Only visible if the result is = control input or state

**Options** Not used, Relay x  
 All the available relays are displayed.

**Factory setting** Not used

---

### Description 'H'

---

**Navigation**  Expert → Application → Maths → Maths x → Description 'H'  
 Direct access code: 400008-00x  
 Examples: Maths 1: 400008-000; Maths 4: 400008-003

**Description** Condition description when the digital input is active. This text is both shown in the display and saved to memory.  
 Only visible if the result is = control input or state

**User entry** Text (max. 6 characters)

**Factory setting** On

---

### Description 'L'

---

**Navigation**  Expert → Application → Maths → Maths x → Description 'L'  
 Direct access code: 400009-00x  
 Examples: Maths 1: 400009-000; Maths 4: 400009-003

**Description** Condition description when the digital input is not active. This text is both shown in the display and saved to memory.  
Only visible if the result is = control input or state

**User entry** Text (max. 6 characters)

**Factory setting** Off

---

### Save event

---

**Navigation**  Expert → Application → Maths → Maths x → Save event  
Direct access code: 400010-00x  
Examples: Maths 1: 400010-000; Maths 4: 400010-003

**Description** Determines whether the condition change from low to high or high to low is stored in the event log.

 Requires higher memory capacity.

Only visible if the result is = control input or state

**Options** No, Yes

**Factory setting** Yes

---

### Event message

---

**Navigation**  Expert → Application → Maths → Maths x → Event message  
Direct access code: 400018-00x  
Examples: Maths 1: 400018-000; Maths 4: 400018-003

**Description** "Do not acknowledge": No message is shown if the digital input switches.  
"Acknowledge": A message window is shown on the screen which has to be acknowledged by operating a push button.  
Only visible if the result is = control input or state

**Options** Do not acknowledge, Acknowledge

**Factory setting** Do not acknowledge

---

### Event text L->H

---

**Navigation**  Expert → Application → Maths → Maths x → Event text L->H  
Direct access code: 400011-00x  
Examples: Maths 1: 400011-000; Maths 4: 400011-003

**Description** Description of condition change from low to high. Event text is stored (e.g. Start filling).  
Only visible if the result is = control input or state

**User entry** Text (max. 22 characters)

---

#### Event text H->L

---

**Navigation**  Expert → Application → Maths → Maths x → Event text H->L  
Direct access code: 400012-00x  
Examples: Maths 1: 400012-000; Maths 4: 400012-003

**Description** Description of condition change from high to low. Event text is stored (e.g. Stop filling).  
Only visible if the result is = control input or state

**User entry** Text (max. 22 characters)

---

#### Record duration

---

**Navigation**  Expert → Application → Maths → Maths x → Record duration  
Direct access code: 400013-00x  
Examples: Maths 1: 400013-000; Maths 4: 400013-003

**Description** The duration between "On" and "Off" can be recorded. The duration is appended to the "Off" event text (<hhhh>h<mm>:<ss>).  
Power outage times do not affect the duration. If the digital channel was "on" before the power outage and is still "on" after the power outage, the duration continues.  
Only visible if the result is = control input or state

**Options** No, Yes

**Factory setting** No

---

#### Zoom start

---

**Navigation**  Expert → Application → Maths → Maths x → Zoom start  
Direct access code: 400016-00x  
Examples: Maths 1: 400016-000; Maths 4: 400016-003

**Description** If the whole value range is not used, you can configure the lower value of the required section here. The zoom has no influence on the storage.  
Only visible if the result is = instantaneous value

**User entry** Number (max. 8 digits)

**Factory setting** 0



---

**Zoom end**



---

<b>Navigation</b>	 Expert → Application → Maths → Maths x → Zoom end Direct access code: 400017-00x Examples: Maths 1: 400017-000; Maths 4: 400017-003
<b>Description</b>	Like "Zoom start". Enter the upper value of the required range here. Only visible if the result is = instantaneous value
<b>User entry</b>	Number (max. 8 digits)
<b>Factory setting</b>	100

---

**Totalizer**



---

<b>Navigation</b>	 Expert → Application → Maths → Maths x → Totalizer Direct access code: 400014-00x Examples: Maths 1: 400014-000; Maths 4: 400014-003
<b>Description</b>	Initial setting for the totalizer. Useful when continuing measurements recorded to date with an (electro)-mechanical counter. Only visible if the result is = counter, operating time from status or operating time from total
<b>User entry</b>	Number (max. 15 digits)
<b>Factory setting</b>	0

---

**Copy settings**



---

<b>Navigation</b>	 Expert → Application → Maths → Maths x → Copy settings Direct access code: 400050-00x Examples: Maths 1: 400050-000; Maths 4: 400050-003
<b>Description</b>	Copies settings from actual channel to selected channel.
<b>Options</b>	Switched off, Maths x Users can choose from all the available maths channels.
<b>Factory setting</b>	Switched off

**Formula editor**

Enter the desired calculation formula. The formula can be any combination of arithmetic calculations and logical operations. Analog, digital or already active mathematics channels can be used.

**Formula editor****Navigation**

 Expert → Application → Maths → Maths x → Formula  
Direct access code: 400002-000

 x = place holder for selected mathematics channel

 A text field with the formula currently used appears. If the field is empty a formula has not yet been defined for the mathematics channel.

**Description**

Individual channels can be mathematically linked and calculated with functions. The mathematics channels calculated in this way are treated as "real" channels, regardless of whether they are connected conventionally or via fieldbus. Enter the desired calculation formula. The formula can be any combination of arithmetic calculations and logical operations. Analog and digital channels can be used, as can mathematics channels that are already active.

A formula with up to 200 characters can be created using this editor. If the formula is finished, click OK to close the editor and accept the formula entered. The common entry and arithmetic operators and inputs are described in detail in the following sections.

*Inputs*

Inputs are described in the formula using the following syntax:

**Input type (signal type;channel number)***Input types:*

Type	Description
AI	Analog inputs
DI	Digital inputs
MI	Mathematics inputs

*Signal type:*

Type	Description
1	Instantaneous value (measured value)
2	State
3	Counter/operational time
5	Validity: The status of an analog channel or a mathematics channel is relayed.  The relayed value of the function is 0 if: <ul style="list-style-type: none"> <li>▪ The "Cable open circuit" flag is set</li> <li>▪ The "Invalid meas. val." flag is set</li> </ul> However the value is not 0 if: <ul style="list-style-type: none"> <li>▪ The "Error value" flag is set</li> <li>▪ The "Over range" or "Under range" flag is set</li> <li>▪ The "No value available" flag is set</li> <li>▪ Limit value flags are set</li> </ul>

**Channel number:**

Analog channel 1 = 1, analog channel 2 = 2, digital channel 1 = 1, ...

*Examples:*

DI(2;4)	The state of digital channel 4
AI(1;1)	The instantaneous value of analog channel 1

**Status of a limit value:**

LMT (limit number)

The function relays the status of a limit value. The result is 1 if the limit value is violated.

The result is 0 if

- The limit value is not violated
- The limit value is not switched on
- Limiting value monitoring is switched off (e.g. per control input)

*Priority of operators / functions*

The formula is processed based on universally applicable mathematics rules:

- Parentheses first
- Exponents before multiplication or division
- Multiplication or division before addition or subtraction
- Calculate from left to right

*Operators**Arithmetic operators:*

Operator	Function
+	Addition
-	Subtraction / negative sign
*	Multiplication
/	Division

*Decimal separator*

Both the decimal point and the decimal comma can be used in the formula editor. Thousand separators are not supported.

*Check whether formula is valid or malfunctions*

A formula is invalid if:

- The channels used are not switched on or are in the wrong operating mode (is not verified during formula entry as the channel could be switched on subsequently)
- It contains invalid characters/formulas/functions/operators
- Syntax errors (e.g. wrong number of parameters) occur in the formulas
- There are incorrect parentheses in the formula (number of open parentheses unequal to number of closed parentheses)
- Division is by zero
- A channel refers to itself (infinite recursion)

Invalid formulas are deactivated when the setup is accepted or the device is started.

Undetectable errors: wherever possible, errors in the formula are reported immediately during input. However, given the possible complexity of the formula entered (e.g. nested formulas) it is not possible to detect every error.

---

### "Totalization" submenu

---

<b>Navigation</b>	 Expert → Application → Maths → Maths x → Totalization
<b>Description</b>	Settings only needed if the calculated value - e.g. for quantity calculation - should be integrated. Analysis time frames, see "Signal analysis".

---

### Totalization

---

<b>Navigation</b>	 Expert → Application → Maths → Maths x → Totalization → Totalization Direct access code: 400050-00x Examples: Maths 1: 400050-000; Maths 4: 400050-003
<b>Description</b>	By totalizing the analog signal (e.g. flow rate in m <sup>3</sup> /h) quantities (in m <sup>3</sup> ) can be calculated.
<b>Options</b>	No, Yes
<b>Factory setting</b>	No

---

### Totalization base

---

<b>Navigation</b>	 Expert → Application → Maths → Maths x → Totalization → Totalization base Direct access code: 400051-00x Examples: Maths 1: 400051-000; Maths 4: 400051-003
<b>Description</b>	Select the required time base. Example: ml/s -> time base seconds (s); m <sup>3</sup> /h -> time base hours (h). Only visible if totalization = yes
<b>Options</b>	Second (s), Minute (min), Hour (h), Day (d)
<b>Factory setting</b>	Second (s)

---

### Unit

---

<b>Navigation</b>	 Expert → Application → Maths → Maths x → Totalization → Unit Direct access code: 400052-00x Examples: Maths 1: 400052-000; Maths 4: 400052-003
-------------------	--

**Description** Enter the unit for the calculated quantity (e.g. "m<sup>3</sup>").  
Only visible if totalization = yes

**User entry** Text (max. 6 characters)

---

### Low flow cut off

---

**Navigation**  Expert → Application → Maths → Maths x → Totalization → Low flow cut off  
Direct access code: 400053-00x  
Examples: Maths 1: 400053-000; Maths 4: 400053-003

**Description** If the volume flow recorded is below the set value, these quantities are not added to the counter.  
If the input is scaled from 0 to y, or if the pulse input is used, all values that are smaller than the set value are not recorded.  
If the input is scaled from -x to +y, all values around the zero point (e.g. also negative values) are not recorded.  
Only visible if totalization = yes

**User entry** Number (max. 8 digits)

**Factory setting** 0

---

### Calc. factor

---

**Navigation**  Expert → Application → Maths → Maths x → Totalization → Calc. factor  
Direct access code: 400054-00x  
Examples: Maths 1: 400054-000; Maths 4: 400054-003

**Description** Factor for calculating the integrated value (e.g. the transmitter delivers l/s -> totalization base = second -> engineering unit required is m<sup>3</sup> -> enter factor 0.001)  
Only visible if totalization = yes

**User entry** Number (max. 8 digits)

**Factory setting** 1.0

---

### Totalizer

---

**Navigation**  Expert → Application → Maths → Maths x → Totalization → Totalizer  
Direct access code: 400055-00x  
Examples: Maths 1: 400055-000; Maths 4: 400055-003

**Description** Initial setting for the totalizer. Useful when continuing measurements recorded to date with an (electro)-mechanical counter.  
Only visible if totalization = yes

**User entry**                      Number (max. 15 digits)

**Factory setting**                0

---

### "Fault mode" submenu

---

**Navigation**                        Expert → Application → Maths → Maths x → Fault mode

**Description**                    Contains settings that specify how this channel is to behave in the event of an error (e.g. if an input channel has a cable open circuit or there is division by 0).

---

### On error

---

**Navigation**                        Expert → Application → Maths → Maths x → Fault mode → On error  
 Direct access code: 400060-00x  
 Examples: Maths 1: 400060-000; Maths 4: 400060-003

**Description**                    Configure what value the device should continue working with (for calculations) if the calculated value is not valid.

**Options**                         Invalid calculation, Error value

**Factory setting**                Invalid calculation

---

### Error value

---

**Navigation**                        Expert → Application → Maths → Maths x → Fault mode → Error value  
 Direct access code: 400061-00x  
 Examples: Maths 1: 400061-000; Maths 4: 400061-003

**Description**                    The device continues calculating with this value in the event of an error.  
 Only visible if on error = error value

**User entry**                      Number (max. 8 digits)

**Factory setting**                0

---

### "Signal analysis" submenu

---



**Navigation**                        Expert → Application → Signal analysis

**Description**                    Contains settings for signal analysis (saving).

---

### Analysis x

---

<b>Navigation</b>	 Expert → Application → Signal analysis → Analysis x Direct access code: 44000x-000 Examples: Analysis 1: 440000-000; Analysis 4: 440003-000
<b>Description</b>	For the set timeframe, determines the minimum, maximum and average value or quantities and operating times.  If the "Externally controlled" option is to be used, a digital input or a maths channel must be set to "Function = Control input" and "Action = Start/stop analysis x". Only analysis 1 can be configured; analyses 2-4 are permanently set to daily analysis, monthly analysis and annual analysis
<b>Options</b>	Switched off, Externally controlled, 1min, 2min, 3min, 4min, 5min, 10min, 15min, 30min, 1h, 2h, 3h, 4h, 6h, 8h, 12h
<b>Factory setting</b>	Switched off

---

### Synchron. time

---

<b>Navigation</b>	 Expert → Application → Signal analysis → Synchron. time Direct access code: 440004-000
<b>Description</b>	Time for completing the signal analysis. If, for example, 07:00 is set up then the daily analysis will run from 07:00 of the actual day until 07:00 of the following day.
<b>User entry</b>	Time
<b>Factory setting</b>	00:00

---

### Reset to zero

---

<b>Navigation</b>	 Expert → Application → Signal analysis → Reset to zero Direct access code: 440005-000
<b>Description</b>	Reset analysis. Note: should only be executed after the device has taken over the setup.
<b>Options</b>	Please select, Analysis x, Totalizer, All
<b>Factory setting</b>	Please select

---

### Reset channel

---



<b>Navigation</b>	 Expert → Application → Signal analysis → Reset channel Direct access code: 440010-000
-------------------	--

<b>Description</b>	Reset analysis of a single channel. Note: should only be executed after the device has taken over the setup.
<b>Options</b>	Please select, Universal input x, Digital input x, Maths x, Set point x, Relay x
<b>Factory setting</b>	Please select

---

### Submenu "Limits - Set point x"

---

<b>Navigation</b>	 Expert → Application → Limits → Set point x
<b>Description</b>	Limit values can monitor the measured values. A relay, for example, can be switched if a limit value is violated. View or change the set-up for the selected alarm set point.  x = place holder for selected limit value

---

### Channel/value

---

<b>Navigation</b>	 Expert → Application → Limits → Set point x → Channel/value Direct access code: 450000-0xx Examples: Set point 1: 450000-000; Set point 30: 450000-029
<b>Description</b>	Select which input/calculated value the limit value refers to.
<b>Options</b>	Switched off, Universal input x, Digital input x, Maths x
<b>Factory setting</b>	Switched off

---

### Type

---

<b>Navigation</b>	 Expert → Application → Limits → Set point x → Type Direct access code: 450001-0xx Examples: Set point 1: 450001-000; Set point 30: 450001-029
<b>Description</b>	Type of limit value (depends on the input variable).
<b>Options</b>	Switched off, Upper set point, Lower set point, Analysis x
<b>Factory setting</b>	Switched off

---

### Identifier

---



<b>Navigation</b>	 Expert → Application → Limits → Set point x → Identifier Direct access code: 450015-0xx Examples: Set point 1: 450015-000; Set point 30: 450015-029
<b>Description</b>	Name of the set point for identification purposes.
<b>User entry</b>	Text (max. 16 characters)
<b>Factory setting</b>	Limit x

---

### Set point

---

<b>Navigation</b>	 Expert → Application → Limits → Set point x → Set point Direct access code: 450003-0xx Examples: Set point 1: 450003-000; Set point 30: 450003-029
<b>Description</b>	Limit value in the set process unit, e.g. in °C, m <sup>3</sup> /h
<b>User entry</b>	Number (max. 10 digits)
<b>Factory setting</b>	0

---

### Hysteresis (abs.)

---

<b>Navigation</b>	 Expert → Application → Limits → Set point x → Hysteresis (abs.) Direct access code: 450004-0xx Examples: Set point 1: 450004-000; Set point 30: 450004-029
<b>Description</b>	The alarm condition is only canceled when the signal has changed into the normal operation range by the preset value.
<b>User entry</b>	Number (max. 8 digits)
<b>Factory setting</b>	0

---

### Time delay

---

<b>Navigation</b>	 Expert → Application → Limits → Set point x → Time delay Direct access code: 450005-0xx Examples: Set point 1: 450005-000; Set point 30: 450005-029
<b>Description</b>	In order to be interpreted as an alarm the signal must exceed or undercut the preset value by at least the time set up.
<b>User entry</b>	Number (max. 5 digits)

**Factory setting** 0

---

### Switches

---

**Navigation**  Expert → Application → Limits → Set point x → Switches  
 Direct access code: 450006-0xx  
 Examples: Set point 1: 450006-000; Set point 30: 450006-029

**Description** Switches the appropriate output in the limit value state.

**Options** Not used, Relay x

**Factory setting** Not used

---

### LV messages

---

**Navigation**  Expert → Application → Limits → Set point x → LV messages  
 Direct access code: 450007-0xx  
 Examples: Set point 1: 450007-000; Set point 30: 450007-029

**Description** Switches the appropriate output in the limit value state.

**Options** Do not acknowledge, Acknowledge

**Factory setting** Do not acknowledge

---

### Save event

---

**Navigation**  Expert → Application → Limits → Set point x → Save event  
 Direct access code: 450008-0xx  
 Examples: Set point 1: 450008-000; Set point 30: 450008-029

**Description** Stores a message in the event log on limit value violation.

**Options** No, Yes

**Factory setting** Yes

---

### Event text LV on

---

**Navigation**  Expert → Application → Limits → Set point x → Event text LV on  
Direct access code: 450009-0xx  
Examples: Set point 1: 450009-000; Set point 30: 450009-029

**Description** This text (including date and time) is shown on the display and/or stored in the event log. Only available if "LV messages" is set to "Acknowledge" or "Save message" is set to "Yes". If no text is entered, the device generates its own text (e.g. Analog 1 > 100%).

**User entry** Text (max. 22 characters)

---

### Event text LV off

---

**Navigation**  Expert → Application → Limits → Set point x → Event text LV off  
Direct access code: 450010-0xx  
Examples: Set point 1: 450010-000; Set point 30: 450010-029

**Description** The same as "Event text LV on", but on return from alarm to normal condition.

**User entry** Text (max. 22 characters)

---

### Record duration of LV on

---

**Navigation**  Expert → Application → Limits → Set point x → Record duration of LV on  
Direct access code: 450011-0xx  
Examples: Set point 1: 450011-000; Set point 30: 450011-029

**Description** The duration of a set point violation can be recorded. The duration is appended to the "limit value off" event text (format: <hhhh>h<mm>:<ss>). Power outage times do not affect the duration. If the set point was violated before the power off and is still violated after the power off, the duration continues.

**Options** No, Yes

**Factory setting** No



---

### Save cycle

---

**Navigation**  Expert → Application → Limits → Set point x → Save cycle  
Direct access code: 450012-0xx  
Examples: Set point 1: 450012-000; Set point 30: 450012-029

**Description** Normal: Save in normal store cycle.  
Alarm cycle: Fast storage during an alarm violation, e.g. every second. Attention: Requires higher memory capacity.

-  ■ The save cycle is set under signal groups (→  133).
- In the event of an alarm violation, all the groups are saved in the alarm cycle.

**Options** Normal, Alarm cycle

**Factory setting** Normal

---

### Draw help line

---

**Navigation**  Expert → Application → Limits → Set point x → Draw help line  
Direct access code: 450013-0xx  
Examples: Set point 1: 450013-000; Set point 30: 450013-029

**Description** The user can configure whether this set point should be displayed in the graphic as a help line (in the color of the channel).

**Options** No, Yes

**Factory setting** No

---

### Copy settings

---

**Navigation**  Expert → Application → Limits → Set point x → Copy settings  
Direct access code: 450200-0xx  
Examples: Set point 1: 450200-000; Set point 30: 450200-029

**Description** Copies settings from actual channel to selected channel.

**Options** Switched off, Set point x (all the set points are displayed)

**Factory setting** Switched off

---

### Submenu "Signal groups - Group x"

---

**Navigation**  Expert → Application → Signal groups → Group x

**Description**  x = place holder for selected group

Group the analog, digital and/or mathematics channels such that you can call up important information at the press of a button during operation (e.g. temperatures, signals in plant unit 1).

 Maximum 8 channels per group!

---

### Identifier



---

<b>Navigation</b>	 Expert → Application → Signal groups → Group x → Identifier Direct access code: 460000-0xx Examples: Set point 1: 460000-000; Set point 30: 460000-029
<b>Description</b>	Enter a name for these groups.
<b>User entry</b>	Text (max. 20 characters)
<b>Factory setting</b>	Group x

---

### Save cycle

---

<b>Navigation</b>	 Expert → Application → Signal groups → Group x → Save cycle Direct access code: 460001-0xx Examples: Set point 1: 460001-000; Set point 30: 460001-029
<b>Description</b>	Configure the save cycle with which this group should be saved in normal conditions (see also set point / save cycle).  The save cycle is independent of the measured value display (see Operating Instructions).
<b>Options</b>	Off, 1s, 2s, 3s, 4s, 5s, 10s, 15s, 20s, 30s, 1min, 2min, 3min, 4min, 5min, 10min, 15min, 30min, 1h
<b>Factory setting</b>	1min

---

### Alarm cycle

---

<b>Navigation</b>	 Expert → Application → Signal groups → Group x → Alarm cycle Direct access code: 460002-0xx Examples: Set point 1: 460002-000; Set point 30: 460002-029
<b>Description</b>	Configure the save cycle with which this group should be saved in an alarm condition (set point violation). Attention: Requires higher memory capacity.
<b>Options</b>	Off, 1s, 2s, 3s, 4s, 5s, 10s, 15s, 20s, 30s, 1min, 2min, 3min, 4min, 5min, 10min, 15min, 30min, 1h
<b>Factory setting</b>	1min

---

### Display blue

---



<b>Navigation</b>	 Expert → Application → Signal groups → Group x → Display blue Direct access code: 460003-00x Examples: Group 1: 460003-000; Group 4: 460003-003
-------------------	---

<b>Description</b>	Choose which input/calculate variable should be displayed in this group.
<b>Options</b>	Switched off, Universal input x, Digital input x, Maths x
<b>Factory setting</b>	Switched off

---

### Display

---

<b>Navigation</b>	 Expert → Application → Signal groups → Group x → Display Direct access code: 460004-00x Examples: Group 1: 460004-000; Group 4: 460004-003
<b>Description</b>	Please select what data from the selected channel should be displayed.  If the "Everything" option is selected, the device switches cyclically between the various values of the channel (instantaneous value, analysis 1 etc.)
<b>Options</b>	Instantaneous value/state, Analysis x, Totalizer, Everything
<b>Factory setting</b>	Instantaneous value/state

---

### Display black

---

<b>Navigation</b>	 Expert → Application → Signal groups → Group x → Display black Direct access code: 460005-00x Examples: Group 1: 460005-000; Group 4: 460005-003
<b>Description</b>	Choose which input/calculate variable should be displayed in this group.
<b>Options</b>	Switched off, Universal input x, Digital input x, Maths x
<b>Factory setting</b>	Switched off

---

### Display

---

<b>Navigation</b>	 Expert → Application → Signal groups → Group x → Display Direct access code: 460006-0xx Examples: Group 1: 460006-000; Group 4: 460006-003
<b>Description</b>	Please select what data from the selected channel should be displayed.
<b>Options</b>	Instantaneous value/state, Analysis x, Totalizer, Everything
<b>Factory setting</b>	Instantaneous value/state

---

**Display red**



---

<b>Navigation</b>	 Expert → Application → Signal groups → Group x → Display red Direct access code: 460007-00x Examples: Group 1: 460007-000; Group 4: 460007-003
<b>Description</b>	Choose which input/calculate variable should be displayed in this group.
<b>Options</b>	Switched off, Universal input x, Digital input x, Maths x
<b>Factory setting</b>	Switched off

---

**Display**



---

<b>Navigation</b>	 Expert → Application → Signal groups → Group x → Display Direct access code: 460008-0xx Examples: Group 1: 460008-000; Group 4: 460008-003
<b>Description</b>	Please select what data from the selected channel should be displayed.
<b>Options</b>	Instantaneous value/state, Analysis x, Totalizer, Everything
<b>Factory setting</b>	Instantaneous value/state

---

**Display green**



---

<b>Navigation</b>	 Expert → Application → Signal groups → Group x → Display green Direct access code: 460009-00x Examples: Group 1: 460009-000; Group 4: 460009-003
<b>Description</b>	Choose which input/calculate variable should be displayed in this group.
<b>Options</b>	Switched off, Universal input x, Digital input x, Maths x
<b>Factory setting</b>	Switched off

---

**Display**

---

<b>Navigation</b>	 Expert → Application → Signal groups → Group x → Display Direct access code: 460010-0xx Examples: Group 1: 460010-000; Group 4: 460010-003
<b>Description</b>	Please select what data from the selected channel should be displayed.

**Options** Instantaneous value/state, Analysis x, Totalizer, Everything

**Factory setting** Instantaneous value/state

---

### Display violet

---

**Navigation**  Expert → Application → Signal groups → Group x → Display violet  
Direct access code: 460011-00x  
Examples: Group 1: 460011-000; Group 4: 460011-003

**Description** Choose which input/calculate variable should be displayed in this group.

**Options** Switched off, Universal input x, Digital input x, Maths x

**Factory setting** Switched off

---

### Display

---

**Navigation**  Expert → Application → Signal groups → Group x → Display  
Direct access code: 460012-0xx  
Examples: Group 1: 460012-000; Group 4: 460012-003

**Description** Please select what data from the selected channel should be displayed.

**Options** Instantaneous value/state, Analysis x, Totalizer, Everything

**Factory setting** Instantaneous value/state

---

### Display orange

---

**Navigation**  Expert → Application → Signal groups → Group x → Display orange  
Direct access code: 460013-00x  
Examples: Group 1: 460013-000; Group 4: 460013-003

**Description** Choose which input/calculate variable should be displayed in this group.

**Options** Switched off, Universal input x, Digital input x, Maths x

**Factory setting** Switched off

---

### Display

---



<b>Navigation</b>	 Expert → Application → Signal groups → Group x → Display Direct access code: 460014-0xx Examples: Group 1: 460014-000; Group 4: 460014-003
<b>Description</b>	Please select what data from the selected channel should be displayed.
<b>Options</b>	Instantaneous value/state, Analysis x, Totalizer, Everything
<b>Factory setting</b>	Instantaneous value/state

---

### Display cyan

---

<b>Navigation</b>	 Expert → Application → Signal groups → Group x → Display cyan Direct access code: 460015-00x Examples: Group 1: 460015-000; Group 4: 460015-003
<b>Description</b>	Choose which input/calculate variable should be displayed in this group.
<b>Options</b>	Switched off, Universal input x, Digital input x, Maths x
<b>Factory setting</b>	Switched off

---

### Display

---

<b>Navigation</b>	 Expert → Application → Signal groups → Group x → Display Direct access code: 460016-0xx Examples: Group 1: 460016-000; Group 4: 460016-003
<b>Description</b>	Please select what data from the selected channel should be displayed.
<b>Options</b>	Instantaneous value/state, Analysis x, Totalizer, Everything
<b>Factory setting</b>	Instantaneous value/state

---

### Display brown

---

<b>Navigation</b>	 Expert → Application → Signal groups → Group x → Display brown Direct access code: 460017-00x Examples: Group 1: 460017-000; Group 4: 460017-003
<b>Description</b>	Choose which input/calculate variable should be displayed in this group.
<b>Options</b>	Switched off, Universal input x, Digital input x, Maths x
<b>Factory setting</b>	Switched off

---

**Display**

---

<b>Navigation</b>	 Expert → Application → Signal groups → Group x → Display Direct access code: 460018-0xx Examples: Group 1: 460018-000; Group 4: 460018-003
<b>Description</b>	Please select what data from the selected channel should be displayed.
<b>Options</b>	Instantaneous value/state, Analysis x, Totalizer, Everything
<b>Factory setting</b>	Instantaneous value/state

---

**Grid divisions**

---

<b>Navigation</b>	 Expert → Application → Signal groups → Group x → Grid divisions Direct access code: 460019-0xx Examples: Group 1: 460019-000; Group 4: 460019-003
<b>Description</b>	Indicates the number of lines ("amplitude grid") that should be displayed. Example: display of 0 ... 100%: select 10 divisions, display 0 ... 14pH: select 14 divisions.
<b>Options</b>	1, 2, 3, 4, 5, 6, 7, 8, 9, 10, 11, 12, 13, 14, 15, 16, 17, 18, 19, 20
<b>Factory setting</b>	10

---

**Zoom**

---

<b>Navigation</b>	 Expert → Application → Signal groups → Group x → Zoom Direct access code: 460028-0xx Examples: Group 1: 460028-000; Group 4: 460028-003
<b>Description</b>	Defines the zoom that is shown in "Curves" or "Waterfall" display mode. This setting does not affect other display modes (e.g. Curves in range, Bar graph etc.).
<b>Options</b>	Do not display, Scroll display, Display blue, Display black, Display red, Display green, Display violet, Display orange, Display cyan, Display brown
<b>Factory setting</b>	Do not display

---

**"E-mail" submenu**

---

<b>Navigation</b>	 Expert → Application → E-mail
-------------------	---

**Description** Contains settings required if alarms are to be transmitted by e-mail.  
 Test the e-mail settings under Diagnostics → Simulation → E-mail.

---

### SMTP host

---

**Navigation**  Expert → Application → E-mail → SMTP host  
 Direct access code: 510062-000

**Description** Enter your SMTP host here. If necessary, contact your network administrator or e-mail provider.  
 Currently, only providers that do not require encryption by TLS/SSL are supported.

**User entry** Text (max. 40 characters)

---

### Port

---

**Navigation**  Expert → Application → E-mail → Port  
 Direct access code: 510063-000

**Description** Enter your SMTP port here. If necessary, contact your network administrator or e-mail provider.

**User entry** Number (max. 4 digits)

**Factory setting** 25

---

### Sender

---

**Navigation**  Expert → Application → E-mail → Sender  
 Direct access code: 510064-000

**Description** Enter the e-mail address of the device here (this text appears as the sender of the e-mail). If necessary, contact your network administrator or e-mail provider.  
 If a valid e-mail address is not configured this might cause e-mail transmission problems, depending on the particular provider.

**User entry** Text (max. 60 characters)

---

### User name



---

<b>Navigation</b>	 Expert → Application → E-mail → User name Direct access code: 510066-000
<b>Description</b>	Configure the user name of the e-mail account here. If necessary, contact your network administrator or e-mail provider.
<b>User entry</b>	Text (max. 60 characters)

---

### "E-mail addresses" submenu



---

<b>Navigation</b>	 Expert → Application → E-mail → E-mail addresses
<b>Description</b>	Here, enter all the e-mail addresses messages should be sent to in the event of an alarm.  Assignment to the alarms is performed later on.

---

### E-mail address x



---

<b>Navigation</b>	 Expert → Application → E-mail → E-mail addresses → E-mail address x Direct access code: 510080-00x Examples: E-mail address 1: 510080-000; E-mail address 5: 510080-004
<b>Description</b>	Here, enter an e-mail address a message should be sent to.  Assignment to the alarms is performed later on.
<b>User entry</b>	Text (max. 60 characters)

---

### "Limit value violations" submenu

---

<b>Navigation</b>	 Expert → Application → E-mail → Limit value violations
<b>Description</b>	Specify who should receive e-mails when limit value violations occur (both on and off messages).  Only for limit values where "Save event" is set to "Yes".

---

### Recipient x

---

<b>Navigation</b>	 Expert → Application → E-mail → Limit value violations → Recipient x Direct access code: 510110-00x Recipient 1: 510110-000; Recipient 2: 510110-001
<b>Description</b>	Select who should receive the email.
<b>Options</b>	Not used, E-mail address x

**Factory setting** Not used

---

### "On/off messages" submenu

---

**Navigation**  Expert → Application → E-mail → On/off messages

**Description** Specify who should receive e-mails when "on"/"off" messages occur (for digital inputs or maths channels).

 Only for inputs where "Save event" is set to "Yes".

---

### Recipient x

---

**Navigation**  Expert → Application → E-mail → On/off messages → Recipient x  
Direct access code: 510115-00x  
Recipient 1: 510115-000; Recipient 2: 510115-001

**Description** Select who should receive the email.

**Options** Not used, E-mail address x

**Factory setting** Not used

---

### "On error" submenu

---

**Navigation**  Expert → Application → E-mail → On error

**Description** Specify who should receive e-mails when errors occur (Fxxx and Sxxx messages).

---

### Recipient x

---

**Navigation**  Expert → Application → E-mail → On error → Recipient x  
Direct access code: 510120-00x  
Recipient 1: 510120-000; Recipient 2: 510120-001

**Description** Select who should receive the email.

**Options** Not used, E-mail address x

**Factory setting** Not used

---

### "Maintenance required" (submenu)

---

**Navigation**  Expert → Application → E-mail → Maintenance required

**Description** Specify who should receive e-mails when maintenance is required (Mxxx messages).

---

#### Recipient x

---

**Navigation**  Expert → Application → E-mail → Maintenance required → Recipient x  
Direct access code: 510130-00x  
Recipient 1: 510130-000; Recipient 2: 510130-001

**Description** Select who should receive the email.

**Options** Not used, E-mail address x

**Factory setting** Not used

### 16.1.6 "Diagnostics" submenu

Unit information and service functions for a swift unit check.

 Only some of the diagnostic functions are available under Expert → Diagnostics! For other functions, see Main menu → Diagnostics

---

#### Current diagnostics

---

**Navigation**  Expert → Diagnostics → Current diagnostics  
Direct access code: 050000-000

**Description** Displays the current diagnosis message.

---

#### Last diagnostics

---

**Navigation**  Expert → Diagnostics → Last diagnostics  
Direct access code: 050005-000

**Description** Displays the last diagnosis message.

---

#### Last restart

---

**Navigation**  Expert → Diagnostics → Last restart  
Direct access code: 050010-000

**Description** Information as to when the device was last restarted (e.g. due to a power failure).

---

**"Diagnosis list" submenu**

---

**Navigation**  Expert → Diagnostics → Diagnosis list

**Description** All pending diagnosis messages are output.

---

**"Event log" submenu**

---

**Navigation**  Expert → Diagnostics → Event log

**Description** Events such as alarm set point infringement and power failure are listed in the correct time sequence.

---

**"Device information" submenu**

---

**Navigation**  Expert → Diagnostics → Device information

**Description** Displays important device information.

---

**Device tag**

---

**Navigation**  Expert → Diagnostics → Device information → Device tag  
Direct access code: 000031-000

**Description** Individual device tag name/unit identifier (max. 17 characters)

---

**Serial number**

---

**Navigation**  Expert → Diagnostics → Device information → Serial number  
Direct access code: 000027-000

**Description** Individual serial number of the device. Please provide these details when ordering spare parts or asking any questions about the unit.

---

**Order code**

---

**Navigation**  Expert → Diagnostics → Device information → Order code  
Direct access code: 000029-000

**Description**

Displays the order code.

The order code indicates the attribute of all the features of the product structure for the device and thus uniquely identifies the device. It can also be found on the nameplate.

**Uses of the order code**

- To order an identical spare device.
- To check the ordered device features using the delivery note.

**Firmware Version****Navigation**

Expert → Diagnostics → Device information → Firmware version  
Direct access code: 000026-000

**Description**

Displays the installed firmware version of the device. Please send these details with any questions about the unit.

**ENP version****Navigation**

Expert → Diagnostics → Device information → ENP version  
Direct access code: 000032-000

**Description**

Displays the version of the electronic nameplate. Please send these details with any questions about the unit.

**ENP device name****Navigation**

Expert → Diagnostics → Device information → ENP device name  
Direct access code: 000020-000

**Description**

Displays the ENP device name (electronic name plate). Please send these details with any questions about the unit.

**Device name****Navigation**

Expert → Diagnostics → Device information → Device name  
Direct access code: 000021-000

**Description**

Displays the device name. Please send these details with any questions about the unit.

**Manufacturer ID**



**Navigation**  Expert → Diagnostics → Device information → Manufacturer ID  
Direct access code: 000022-000

**Description** Displays the manufacturer ID.

---

### Manufacturer name

---

**Navigation**  Expert → Diagnostics → Device information → Manufacturer name  
Direct access code: 000023-000

**Description** Displays the manufacturer name. Please send these details with any questions about the unit.

---

### Firmware

---

**Navigation**  Expert → Diagnostics → Device information → Firmware  
Direct access code: 009998-000

**Description** Displays the installed firmware of the device. Please send these details with any questions about the unit.

---

### "Simulation" submenu

---

**Navigation**  Expert → Diagnostics → Simulation

**Description** Settings for simulation mode.

---

### Operating mode

---

**Navigation**  Expert → Diagnostics → Simulation → Operating mode  
Direct access code: 010010-000

**Description** Normal operation: Unit plots the signals from the connected measurement points. Simulation: Instead of operating with the real measurement points the signals are simulated (using the actual settings).

**Options** Normal operation, Simulation

**Factory setting** Normal operation

# Index

- 0 ... 9**
- 1 hour= (parameter) . . . . . 100
  - 1 second= (parameter) . . . . . 100
- A**
- Access code (parameter) . . . . . 76
  - Acknowledging messages (parameter) . . . . . 79
  - Action (parameter) . . . . . 100, 117
  - Activation code (parameter) . . . . . 82
  - Actual value (parameter) . . . . . 92, 92
  - Administrator (parameter) . . . . . 110
  - Alarm cycle (parameter) . . . . . 133
  - Analysis software
    - Functional range . . . . . 27
  - Analysis x (parameter) . . . . . 126
  - Application (parameter) . . . . . 83
  - Application (submenu) . . . . . 115
- B**
- Baudrate (parameter) . . . . . 112, 115
  - Begin summer time (parameter) . . . . . 72
- C**
- Cable open circuit detection (parameter) . . . . . 95
  - Calc. factor (parameter) . . . . . 94, 125
  - CE mark (declaration of conformity) . . . . . 8
  - Change date/time (submenu) . . . . . 70
  - Channel ident. . . . . 85
  - Channel ident. (parameter) . . . . . 98
  - Channel/value (parameter) . . . . . 128
  - Clear memory (parameter) . . . . . 69
  - Communication
    - Ethernet TCP/IP . . . . . 17
  - Communication (parameter) . . . . . 83
  - Communication (submenu) . . . . . 105
  - Comparison point (parameter) . . . . . 89
  - Comparison temp. (parameter) . . . . . 89
- Configuration Web server (submenu) . . . . . 109
- Connection . . . . . 85
  - Copy settings (parameter) . . . . . 90, 104, 121, 132
  - Correction RPT (parameter) . . . . . 91
  - CSV settings (parameter) . . . . . 78
  - Current date/time (parameter) . . . . . 70
  - Current diagnostics (parameter) . . . . . 142
- D**
- Damping (parameter) . . . . . 89
  - Date (parameter) . . . . . 73, 74
  - Date format (parameter) . . . . . 69
  - Date/time (parameter) . . . . . 71, 79
  - Date/time (submenu) . . . . . 70
  - Date/time set-up (submenu) . . . . . 69
  - Day (parameter) . . . . . 72, 73
  - Decimal point . . . . . 86
  - Decimal point (parameter) . . . . . 99, 117
  - Decimal separator (parameter) . . . . . 68
  - Declaration of Conformity . . . . . 8
  - Description 'H' (parameter) . . . . . 101, 118
  - Description 'L' (parameter) . . . . . 102, 118
  - Device info (submenu) . . . . . 143
  - Device name . . . . . 144
  - Device options (submenu) . . . . . 81
  - Device tag . . . . . 143
  - Device tag (parameter) . . . . . 67
  - DHCP (parameter) . . . . . 106
  - Diagnosis list (submenu) . . . . . 143
  - Diagnostic messages . . . . . 43
  - Diagnostics (submenu) . . . . . 142
  - Digital inputs (submenu) . . . . . 97
  - Direct access (parameter) . . . . . 67
  - Disable port (parameter) . . . . . 107
  - Display (parameter) 134, 134, 135, 135, 136, 136, 137, 137, 138
  - Display black (parameter) . . . . . 134
  - Display blue (parameter) . . . . . 133
  - Display brown (parameter) . . . . . 137
  - Display cyan (parameter) . . . . . 137
  - Display green (parameter) . . . . . 135
  - Display orange (parameter) . . . . . 136
  - Display red (parameter) . . . . . 135
  - Display violet (parameter) . . . . . 136
  - Domain Name System (parameter) . . . . . 107
  - Draw help line (parameter) . . . . . 132
- E**
- E-mail (submenu) . . . . . 138
  - E-mail address x (parameter) . . . . . 140
  - E-mail addresses (submenu) . . . . . 140
  - End summer time (parameter) . . . . . 73
  - Engineering unit . . . . . 85
  - Engineering unit (parameter) . . . . . 98, 117
  - ENP device name . . . . . 144
  - ENP version . . . . . 144
  - Error (submenu) . . . . . 141
  - Error messages . . . . . 43
  - Error value (parameter) . . . . . 126
  - Ethernet . . . . . 29
  - Ethernet configuration (submenu) . . . . . 106
  - Event log (submenu) . . . . . 143
  - Event message (parameter) . . . . . 102, 119
  - Event text H->L (parameter) . . . . . 103, 120
  - Event text L->H (parameter) . . . . . 103, 119
  - Event text LV off (parameter) . . . . . 131
  - Event text LV on (parameter) . . . . . 130
  - Expert (Menu) . . . . . 67
  - External memory (submenu) . . . . . 77
- F**
- Failsafe value (parameter) . . . . . 97
  - Fault mode (submenu) . . . . . 95, 126
  - Fault switching (parameter) . . . . . 68

- Fieldbus (parameter) . . . . . 83  
 Firmware (parameter) . . . . . 145  
 Firmware version (parameter) . . . . . 144  
 Formula (parameter) . . . . . 116  
 Formula editor (parameter) . . . . . 122  
 Formula editor (submenu) . . . . . 122  
 Function (parameter) . . . . . 97, 98, 115
- G**  
 Gateway (parameter) . . . . . 107  
 Grid divisions (parameter) . . . . . 138
- H**  
 Hysteresis (abs.) (parameter) . . . . . 129
- I**  
 ID (parameter) . . . . . 110, 111, 111  
 Identifier (parameter) . . . . . 105, 128, 132  
 Input factor in (parameter) . . . . . 99  
 Inputs (submenu) . . . . . 84  
 IP address (parameter) . . . . . 106
- K**  
 Keyboard layout (parameter) . . . . . 68
- L**  
 Language (parameter) . . . . . 67  
 Last diagnostics (parameter) . . . . . 142  
 Last restart (parameter) . . . . . 142  
 Limit value violations (submenu) . . . . . 140  
 Limits (submenu) . . . . . 128  
 Lock hardware (parameter) . . . . . 77  
 Low flow cut off (parameter) . . . . . 94, 125  
 Lower error value (parameter) . . . . . 96  
 Lower frequency (parameter) . . . . . 87  
 LV messages (parameter) . . . . . 130
- M**  
 MAC address (parameter) . . . . . 106  
 Maintenance required (submenu) . . . . . 141  
 Manufacturer ID (parameter) . . . . . 144  
 Manufacturer name . . . . . 145  
 Maths (submenu) . . . . . 115  
 Meas. range end (parameter) . . . . . 88, 92  
 Measured value correction (submenu) . . . . . 90  
 Memory build-up (parameter) . . . . . 77  
 Messages (submenu) . . . . . 79  
 Modbus (parameter) . . . . . 113  
 Modbus RTU/(TCP/IP) . . . . . 29  
 Modbus Slave (submenu) . . . . . 113  
 Modbus Slave serial interface (submenu) . . . . . 114  
 Month (parameter) . . . . . 72, 74
- N**  
 NAMUR NE 43 (parameter) . . . . . 95  
 NT/ST changeover (parameter) . . . . . 71  
 NT/ST changeover (submenu) . . . . . 71  
 NT/ST region (parameter) . . . . . 71
- O**  
 Occurrence (parameter) . . . . . 72, 73  
 OFF daily from (parameter) . . . . . 81  
 Offset (parameter) . . . . . 91  
 ON daily from (parameter) . . . . . 80  
 On error (parameter) . . . . . 96, 126  
 On/off messages (submenu) . . . . . 141  
 OPC port (parameter) . . . . . 108  
 OPC server  
   Functional range . . . . . 27  
 Operating mode (parameter) . . . . . 104, 145  
 Operation options  
   Local operation . . . . . 21  
   Operating tool . . . . . 21  
   Overview . . . . . 21  
 Operational safety . . . . . 7  
 Operational time (parameter) . . . . . 79  
 Operator (parameter) . . . . . 110  
 Order code . . . . . 143  
 Output (submenu) . . . . . 104  
 Overview of symbols . . . . . 25
- P**  
 Parity (parameter) . . . . . 113, 115  
 Password (parameter) . . . . . 110, 111, 111  
 Plot type . . . . . 85  
 Plot type (parameter) . . . . . 116  
 Port (parameter) . . . . . 108, 109, 114, 139  
 PRESET (parameter) . . . . . 69  
 Product safety . . . . . 8  
 Protected by (parameter) . . . . . 76  
 Protocol (parameter) . . . . . 112  
 Pulse counter . . . . . 86  
 Pulse value . . . . . 86
- R**  
 Range . . . . . 84  
 Range start (parameter) . . . . . 87, 91  
 Recipient x (parameter) . . . . . 140, 141, 141, 142  
 Record duration (parameter) . . . . . 103, 120  
 Record duration of LV on (parameter) . . . . . 131  
 Relay (submenu) . . . . . 104  
 Reset channel (parameter) . . . . . 127  
 Reset to zero (parameter) . . . . . 127
- S**  
 Save as (parameter) . . . . . 77  
 Save cycle (parameter) . . . . . 131, 133  
 Save event (parameter) . . . . . 97, 102, 119, 130  
 Screen saver (parameter) . . . . . 80, 81  
 Screen saver (submenu) . . . . . 80  
 SD card (parameter) . . . . . 77  
 Security (submenu) . . . . . 76  
 Sender (parameter) . . . . . 139  
 Separator for CSV (parameter) . . . . . 78  
 Serial interface (submenu) . . . . . 112  
 Serial number . . . . . 143  
 Service (parameter) . . . . . 111  
 Set point (parameter) . . . . . 129

Set point code (parameter) . . . . . 76  
 Setup (parameter) . . . . . 109  
 Setup via web server . . . . . 32  
 Signal . . . . . 84  
 Signal analysis (submenu) . . . . . 126  
 Signal groups (submenu) . . . . . 132  
 Simulation (submenu) . . . . . 145  
 Slot 1 (parameter) . . . . . 82  
 Slot 2 (parameter) . . . . . 82  
 Slot 3 (parameter) . . . . . 82  
 SMTP host (parameter) . . . . . 139  
 SNTP (parameter) . . . . . 75  
 SNTP (submenu) . . . . . 75  
 SNTP server 1 (parameter) . . . . . 75  
 SNTP server 2 (parameter) . . . . . 75  
 Staff  
   Requirements . . . . . 7  
 Structure of the operating menu . . . . . 21, 22  
 Subnetmask (parameter) . . . . . 107  
 Switches (parameter) . . . . . 105, 130  
 Switches relay (parameter) . . . . . 78, 80, 101, 118  
 Symbols  
   Operating menus . . . . . 26  
 Synchron. time (parameter) . . . . . 127  
 System (submenu) . . . . . 67

**T**

Target value (parameter) . . . . . 91, 92  
 Temperature unit (parameter) . . . . . 68  
 Text entry . . . . . 26  
 The result is (parameter) . . . . . 116  
 Time (parameter) . . . . . 73, 74  
 Time delay (parameter) . . . . . 100, 129  
 Time format (parameter) . . . . . 69  
 Timeout (parameter) . . . . . 105, 114  
 Totalization (parameter) . . . . . 93, 124  
 Totalization (submenu) . . . . . 93, 124, 124  
 Totalization base (parameter) . . . . . 93, 124  
 Totalizer (parameter) . . . . . 90, 95, 103, 121, 125  
 Troubleshooting  
   Alarm relay . . . . . 42  
   Modbus RTU . . . . . 43  
   Modbus TCP . . . . . 43  
 Type (parameter) . . . . . 128  
 Type RS232/RS485 (parameter) . . . . . 112

**U**

Unit (parameter) . . . . . 94, 124  
 Unit address (parameter) . . . . . 113, 114  
 Universal inputs (submenu) . . . . . 84  
 Upper error value (parameter) . . . . . 96  
 Upper frequency (parameter) . . . . . 87  
 User name (parameter) . . . . . 139  
 UTC time zone (parameter) . . . . . 70, 70

**V**

Value per pulse (parameter) . . . . . 99

**W**

Warning at (parameter) . . . . . 78

Web server . . . . . 37  
   Functional range . . . . . 27  
 Web server (parameter) . . . . . 108  
 Web server authentication (submenu) . . . . . 110  
 Workplace safety . . . . . 7

**Z**

Zoom (parameter) . . . . . 138  
 Zoom end (parameter) . . . . . 88, 121  
 Zoom start (parameter) . . . . . 88, 120