

# Device handbook

## CAM mobile

Operating Instructions CAM mobile  
06/2014



Camille Bauer Metrawatt AG  
Aargauerstrasse 7  
CH-5610 Wohlen / Switzerland  
Phone: +41 56 618 21 11  
Telefax: +41 56 618 35 35  
E-Mail: [info@cbmag.com](mailto:info@cbmag.com)  
<http://www.camillebauer.com>

 **CAMILLE BAUER**  
Rely on us.

## Legal information

### Warning notices

In this document warning notices are used, which you have to observe to ensure personal safety and to prevent damage to property. Depending on the degree of danger the following symbols are used:



If the warning notice is not followed death or severe personal injury **will** result.



If the warning notice is not followed damage to property or severe personal injury **may** result.



If the warning notice is not followed the device **may** be damaged or **may** not fulfill the expected functionality.

### Qualified personnel

The product described in this document may be handled by personnel only, which is qualified for the respective task. Qualified personnel have the training and experience to identify risks and potential hazards when working with the product. Qualified personnel are also able to understand and follow the given safety and warning notices.

### Intended use

The product described in this document may be used only for the application specified. The maximum electrical supply data and ambient conditions specified in the technical data section must be adhered. For the perfect and safe operation of the device proper transport and storage as well as professional assembly, installation, handling and maintenance are required.

### Disclaimer of liability

The content of this document has been reviewed to ensure correctness. Nevertheless it may contain errors or inconsistencies and we cannot guarantee completeness and correctness. This is especially true for different language versions of this document. This document is regularly reviewed and updated. Necessary corrections will be included in subsequent version and are available via our webpage <http://www.camillebauer.com>.

### Feedback

If you detect errors in this document or if there is necessary information missing, please inform us via e-mail to: [customer-support@camillebauer.com](mailto:customer-support@camillebauer.com)









## Contents

1	Safety precautions.....	5
2	Scope of delivery.....	6
3	Device overview .....	7
4	Preparation of measurement application.....	8
4.1	Installation of the CB-Manager Software .....	8
4.2	Connecting CAM mobile to PC .....	8
4.3	Parameterization of the CAM mobile .....	8
4.3.1	Parameterization of the measurement input.....	8
4.3.2	Parameterization of the measurements to record .....	9
4.3.3	Defining events to monitor .....	10
4.3.4	Defining measurement data to record .....	11
4.3.5	Parameterization of the display .....	13
4.3.6	Save configuration .....	13
4.3.7	Starting the logger.....	13
5	Connecting the device on-site .....	14
5.1	General warnings .....	14
5.2	Connecting power supply .....	14
5.3	Connecting current and voltage inputs .....	14
6	Checking the correct installation.....	19
6.1	By means of the PC-Software .....	19
6.2	Via measurement display .....	19
7	Performing measurements .....	20
8	Analysis of recorded data .....	21
9	Service and maintenance .....	27
9.1	Protection of data integrity.....	27
9.2	Calibration and new adjustment .....	27
9.3	Cleaning.....	27
9.4	Battery.....	27
9.5	Disposal .....	27
10	Technical data .....	28
	Appendix.....	30
A	Description of measured quantities .....	30
A1	Basic measurements.....	30
A2	Harmonic analysis .....	33
A3	Mean values and trend.....	34
A4	Meters .....	35
B	Graphic display.....	36
B1	Display structure and operation .....	37
B2	Settings.....	38
B2.1	Settings of the display .....	38
B2.2	Settings of the interface.....	38
B2.3	Settings of the clock .....	39
B3	Security system .....	40
B4	Display measurements .....	41

B4.1	Customer specific measurement displays .....	41
B4.2	Measurement display of system quantities .....	42
B4.3	Measurement display of harmonics.....	43
B4.4	Display meter contents .....	44
B4.5	Measurements of I/O's and relays .....	44
B4.6	Measurement display of mean values .....	45
B4.7	Measurements for wiring control .....	45
B5	Alarms .....	46
B6	Lists.....	47
B7	Logger .....	50
B8	Menu overview .....	51
<b>C</b>	<b>Operating instructions Rogowski coils .....</b>	<b>52</b>
C1	Safety .....	52
C2	Introduction .....	53
C3	Specifications .....	54
C4	Operation .....	55
C4.1	Measuring current.....	55
C4.2	Operation.....	55
C5	Maintenance.....	55
<b>D</b>	<b>Installation of PC software.....</b>	<b>56</b>
D1	Installation of CB-Manager software .....	56
D1.1	For Windows 2000 / Windows XP .....	56
D1.2	For Windows Vista / Windows 7 .....	57
D1.3	USB support .....	57
D1.4	First run of the CB-Manager software .....	58
D1.5	Remedy for USB communication problems .....	58
D1.6	Removing USB devices from the control panel.....	60
D2	Installation of CB-Analyzer software.....	61
D2.1	Installation of the base software .....	61
D2.2	Installation of Microsoft .NET framework 4 .....	62
D2.3	First run of the CB-Analyzer software .....	63
D2.4	Remedy for communication problems.....	64
D3	Turn off User Account Control of Windows Vista / 7 .....	65
<b>E</b>	<b>Declaration of conformity .....</b>	<b>66</b>

# 1 Safety precautions

The power analyzer **CAM mobile** has been designed as a protection class I instrument in accordance with the safety regulations IEC/EN 61010-1. To ensure the safety of the operating staff a protective earth via the power supply connector is mandatory and the following warnings must be adhered to. Safety is not guaranteed if warnings are not followed or if the device is operated incorrectly or handled improperly. Reference is made to the following warnings at corresponding points in the subsequent text to assure their compliance.

 1	The power supply for the CAM mobile must be provided via the IEC power connector on the backside of the device using a three conductor IEC power cord. Under all circumstances this cord must provide a connection to protective earth. If no connection to protective earth is provided or if protection is disabled by using an extension cord without protective conductor the device may be hazardous.
 2	The device may only be operated by trained personnel who are capable of recognizing contact hazards and implementing appropriate safety precautions. Hazards are present anywhere, where voltages with a potential of higher than 50V to ground may occur.
 3	When performing measurements involving contact hazards a second person should always be present. Typically this is the case during connecting current and voltage inputs.
 4	The connection of the measurement inputs may be performed not before the device has been connected to protective earth in accordance with warning 1. The maximum allowed potential of current and voltage inputs is: 300V CATIII resp. 600V CATIII
 5	Only use measurement leads which are in perfect condition. Especially the insulation may not be damaged. It must be assumed that unexpected voltages may occur at measurement objects. Capacitors, for example, may be dangerously charged.
 6	Measurements under damp ambient conditions are not allowed. The device may not be exposed to moisture.
 7	The device must be put out of operation if a safe operation, e.g. due to visible damages, is no longer possible. To do so, you have to switch-off all connections first. Then the device has to be sent to our factory resp. to an authorized service center.
 8	Opening the device is not allowed. Live parts may be exposed. Any intervention in the device will void the warranty. Maintenance and repair work must be carried out by our service center only.
	Device may only be disposed of in a professional manner !

## 2 Scope of delivery

Upon receive of delivery check device and supplied accessories for completeness and integrity:

#	Description	o.k.
1	CAM mobile Power analyzer	<input type="checkbox"/>
4	Test leads for voltage inputs, with test probes and plug-on dolphin clips	<input type="checkbox"/>
1	Three-phase Rogowski coils 30/300/3000A for measuring phase currents	<input type="checkbox"/>
1	(optional) single-phase Rogowski coil 30/300/3000A for neutral current measurement	<input type="checkbox"/>
1	IEC power cord with protective earth contact	<input type="checkbox"/>
1	USB interface cable	<input type="checkbox"/>
1	Carrying case	<input type="checkbox"/>
1	Device handbook	<input type="checkbox"/>
1	CD-ROM with configuration and analysis software as well as documentation	<input type="checkbox"/>



### Leads for voltage measurement

For security reasons leads for voltage measurement are equipped with the following fuse:

SIBA, type 7017240, 6.3 x 32mm, very fast acting  
FF 500mA / 1000V / 30kA



The fuse should only be replaced by a fuse of the same type.

To replace the fuse the probe can be screwed on.

### 3 Device overview

The CAM mobile is a measurement device to be used in any low voltage power distribution. It bases on the SINEAX CAM, a proven universal measurement unit for heavy-current quantities, equipped with data logger, lists, display and USB interface. The CAM mobile is designed for the non-stationary analysis of energy demand and system state quantities. It provides the following capabilities to the user:

- Continuous analysis of present system state
- Acquisition of disturbances, as voltage fluctuations or voltage sags
- Acquisition of system load variations over time
- Investigation of billing relevant quantities as peak load, load characteristic and active / reactive energy demand summaries

By using Rogowski coils a wide application field in distributions from 30 up to 3000A may be covered. For the configuration of the device before the application in the field and the subsequent data analysis PC skills are required, because the device itself can only visualize measurements but does not allow performing any settings or detailed analyses.

In the following chapters the planning of the device application, the performing of the measurement and the analysis of the recorded data is described in detail. The following main topics will be described:

- A Preparation of measurement application**: By means of the CB-Manager software (on CD) the measurement functionality can be pre-configured, the events to be monitored can be fixed and the data logger can be parameterized.
- B Connecting the device on-site**
- C Checking the correct installation**
- D Performing the measurement**
- E Analysis of recorded data**: By means of the CB-Analyzer software (on CD) measurement data can be analyzed and if desired exported for further analysis in other programs.

## 4 Preparation of measurement application

Before performing measurements the CAM mobile must be configured for the measurement application via the USB interface, because via display no such settings can be performed. To do so, the device must be supplied with power. The subsequent described parameterization is done using the CB-Manager software.

### 4.1 Installation of the CB-Manager Software

The installation of the CB-Manager software is described in detail in the file „Read-me-first.pdf“ on the supplied CD and is as well shown in [Appendix D1](#). After starting the application „Setup.exe“ in the directory „Software CB-Manager Vxxx“ the CB-Manager and the USB driver will be installed. The USB driver is required for the later communication with the device.

### 4.2 Connecting CAM mobile to PC

Observe **warning 1** of the safety precautions

Connect the device to an applicable power supply by means of the IEC power cord and switch the device on. Then connect the USB connector of the CAM mobile to a USB connector of the PC.

### 4.3 Parameterization of the CAM mobile

After the first start-up of the software set the communication interface to „USB“ using the menu item options | interface. Once done use *system / search devices* to bring the CAM mobile into the device list. By double-clicking on the appropriate symbol in the device list the present parameterization of the device is read and displayed.



*For configuration parameters a context-sensitive help is available in the CB-Manager, which describes the meaning of the specific settings. To display just right-click with the mouse on the corresponding input field.*

#### 4.3.1 Parameterization of the measurement input

In the register „input“ the features of the system to monitor can be defined. Along with the system type expectations of the maximum signal levels must be defined, i.e. the maximum overriding of the voltage and current quantities which should still be measurable.



The configuration of the **current inputs** has to match the setting of the rotary-switch of the Rogowski coils. The coils support the following three ranges:

Range	Sensitivity per [A]
30A	100mV
300A	10mV
3000A	1mV

**Example:** You want to measure max. 200 A with 10% over range

- Current input: prim. 200A / sec. 2V
- Position of rotary-switch: 300 A





**System** 4-wire system, asymmetrical  
 left-hand rotation       Interrupted signal

**voltage input** 400.00 [V]      400.00 [V]  
 L - L max. 480.00 [V]      480.00 [V]

**current input** 200.00 [A]      2.00 [A]  
 max. 220.00 [A]      2.20 [A]

**Overriding** voltage 20.00 %  
 current 10.00 %

**Averaging time** RMS values 8 Cycles  
 IB 15 Min

**System frequency** 50.00 Hz  
 unfiltered      Frequency measuring via voltage  
 Fixed frequency for sampling

**Quadrants assignment**

### 4.3.2 Parameterization of the measurements to record

In the register „mean values“ those quantities can be selected, which should be recorded later over a longer time period.

**mean values**

Interval time	t1	Interval time	t2
1: current I1		1: active power P	incoming
2: current I2		2: active power P1	incoming
3: current I3		3: active power P2	incoming
4: voltage U1N		4: active power P3	incoming
5: voltage U2N		5: reactive power Q	incoming
6: voltage U3N		6: power factor LF	
7: not used		7: not used	
8: not used		8: not used	
9: not used		9: not used	
10: not used		10: not used	
11: not used		11: not used	
12: not used		12: not used	

**Synchronization** internal

**interval** 60 s

**Synchronization** internal

**interval** 900 s

Two different groups of mean values with up to 12 quantities each are supported. Typically of the groups is used with a longer interval time, e.g. 900s = 15min. for recordings load profiles, and the other one with a shorter interval time, e.g. 60s for basic quantities such as voltage or current. The synchronization of these intervals must be set to „internal“ (via built-in RTC), because no external synchronization source is supported.

### 4.3.3 Defining events to monitor

To detect and record the occurrence of special situation, such as overload or phase failure, limit values can be defined. The state of a limit or a combination of multiple limit states can then in the logic module be classified as event or alarm. So each changing can be recorded in the appropriate event lists with the time-stamp of its occurrence. Up to 64 limit values and up to 32 logic functions (events to monitor) may be defined.

#### Example: Monitoring an overload situation

	measured quantity	limit for ON state	limit for OFF state	unit
1	active power P1	32.00	31.80	kW
2	active power P2	32.00	31.80	kW
3	active power P3	32.00	31.80	kW
4	not used	0.00	0.00	
5	not used	0.00	0.00	

In the register „limit values“ for each active phase power a limit value is defined. For each limit you have define the values limit for ON state and limit for OFF state.

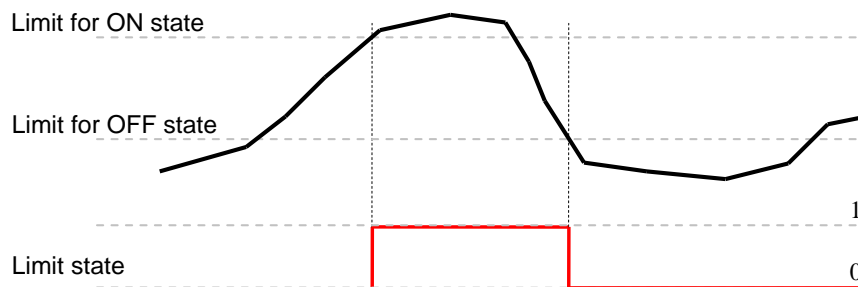

Depending on the application limit values are used to monitor if a value is exceeded (upper limit) or falls below a certain limit (lower limit). The limit for ON state always corresponds to the measurement where the limit state changes to „1“, the limit for OFF state is the measurement for which the state changes back to „0“. The difference of the two values corresponds to the hysteresis.

In the „**logic module**“ the states of the three monitored phase powers will be defined as input for the logic function LS <1> and combined using a logical „OR“. If one of the three limit values is exceeded, the logic output becomes „1“. This way a list entry “overload” into the event list is initiated. As soon as the logic output goes back to „0“ the text “load o.k.” will be written into the event list.

States of limit values are the most important input quantities of the logic module. If more than 3 inputs are required, the result of a logic function can be used as input for the next function. For that you have to know that logic functions are evaluated in the sequence 1...32. Thus it's meaningful to use the result of a logic function c in a logic function x+n to assure that further processing is performed in the current evaluation cycle, rather than in the next cycle.

For completeness the truth tables of the usable logical functions are shown below. For simplicity their functionality has been reduced to gates with two inputs only.

function	symbol	older symbols		truth table	plain text		
		ANSI 91-1984	DIN 40700 (alt)				
<b>AND</b>				A	B	Y	Function is true if all input conditions are fulfilled
				0	0	0	
				0	1	0	
				1	0	0	
				1	1	1	
<b>NAND</b>				A	B	Y	Function is true if at least one of the input conditions is <b>not</b> fulfilled
				0	0	1	
				0	1	1	
				1	0	1	
				1	1	0	
<b>OR</b>				A	B	Y	Function is true if at least one of the input conditions is fulfilled
				0	0	0	
				0	1	1	
				1	0	1	
				1	1	1	
<b>NOR</b>				A	B	Y	Function is true if <b>none</b> of the input conditions is fulfilled
				0	0	1	
				0	1	0	
				1	0	0	
				1	1	0	
<b>XOR</b>				A	B	Y	Function is true if exactly one of the input conditions is fulfilled
				0	0	0	
				0	1	1	
				1	0	1	
				1	1	0	
<b>XNOR</b>				A	B	Y	Function is true if all of the input conditions are fulfilled or all conditions are not fulfilled
				0	0	1	
				0	1	0	
				1	0	0	
				1	1	1	

#### 4.3.4 Defining measurement data to record

After the definition of event controlled recording data measurements may be selected, which shall be recorded in periodical intervals over a longer time period. In the final step you select how much of the available memory will be reserved for each logger / list type.

In the register „**Logger of the meters**“ you can select which of the available meters shall be read and recorded in regular intervals. In the following example the meters for incoming active and reactive energy are selected, to be read every day at 00:00.

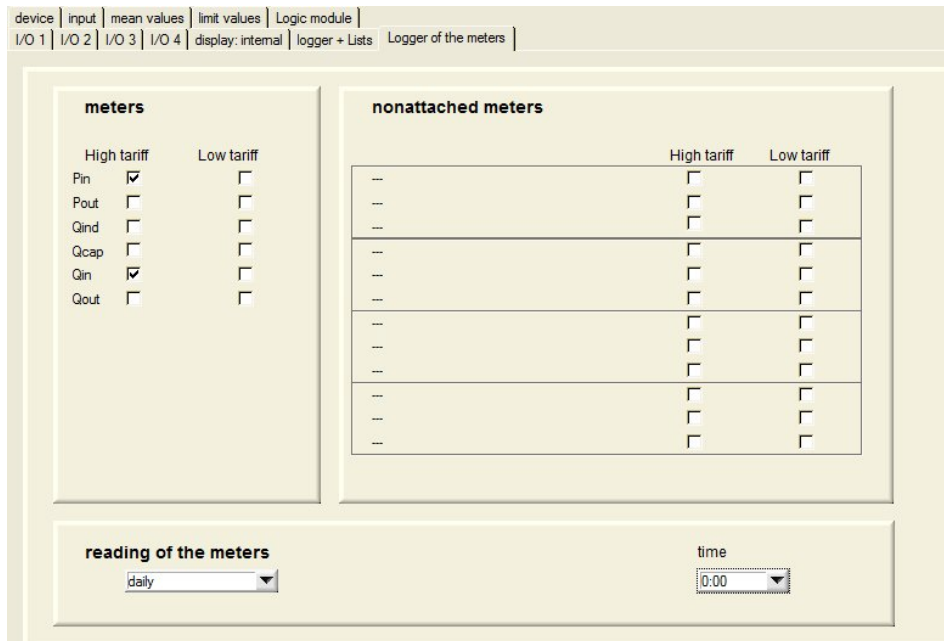

In the register „**Logger + Lists**“ those mean-values can be selected which have to be recorded with spaces of the associated intervals. In the example:

- U1N, U2N, U3N, I1, I2, I3, IN in intervals of 60s
- P1, P2, P3, Q1, Q2, Q3 in intervals of 900s

For up to six quantities the recording of min/max values can be selected. Thereby for each selected measured quantity its minimum and maximum **RMS value** within the interval will be stored. This allows finding load variations, to detect e.g. possible breaks of the power supply at an early stage. In the example:

- min/max RMS-values for P1, P2, P3 for each 15 minutes interval

For a temporary measurement using the CAM mobile the **memory utilization** should be selected, that most of the data logger parts allows the same storage (in the example 153 days). For lists this is not possible directly, but you can define the maximum number of storable events.

Data recording may be performed one-time or in **endless mode**. This can be selected individually for each logger. In contrast lists generally work in endless mode. If one-time recording is selected storage is stopped as soon as the maximum memory space is used. In endless mode the oldest data will be deleted when the maximum is reached.

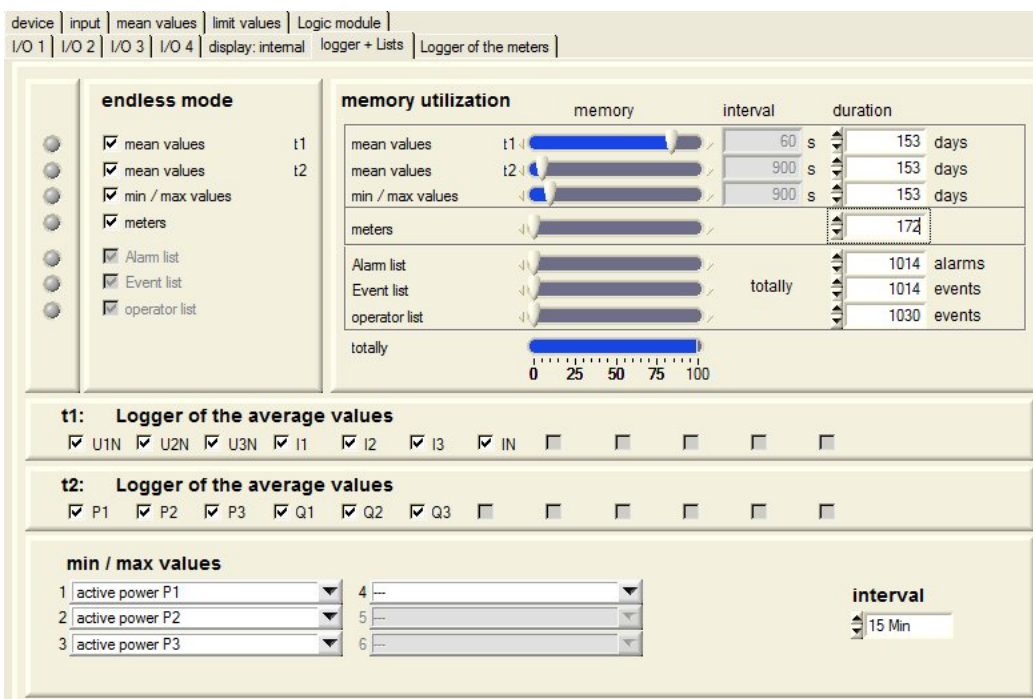

### 4.3.5 Parameterization of the display

The graphic display is intended for on-site visualization of measurement data, lists and alarms of the CAM mobile. The operation of the display is performed menu-driven by means of the keys. In addition to predefined displays the user can define free measurement assemblies via the register „display: internal“. If needed also a preference display or automatic changing measurement displays can be configured.

The menu navigation can be done in 7 languages. The change of the language can be performed also locally via the display. The operation of the display is described in [Appendix B](#). Operating instructions in other languages may be found on the supplied CD.

### 4.3.6 Save configuration

To activate the new configuration it must be downloaded to the device. This may be done by selecting the button „Download to device“.

 Note that the logger will not automatically be activated when the configuration is downloaded. See „4.3.7 Starting the logger“.

It's recommended to store the configuration for security reasons on the PC. So later on you will also be able to make OFFLINE (without a device connected) modifications, which then may be downloaded to the device on-site. Saving of configurations is performed via the file menu:

*File | parameters | save file*

### 4.3.7 Starting the logger

When downloading the configuration to the device the state of each logger part is not changed. If one of the logger parts mean values t1 / t2, min/max values or meters was active it remains active after downloading, otherwise it remains inactive.

 **The state of the logger will not be changed by a power failure or by switching off the device. Therefore the CAM mobile may be transported to the place of action, without the need to start the logger again on-site.**

Starting or stopping of logger parts is done via the context menu in the device list. Doing so, the content of the individual data loggers will not be changed. All data already stored will remain stored.

Using the right mouse key click on the device in the device list and select the logger menu:

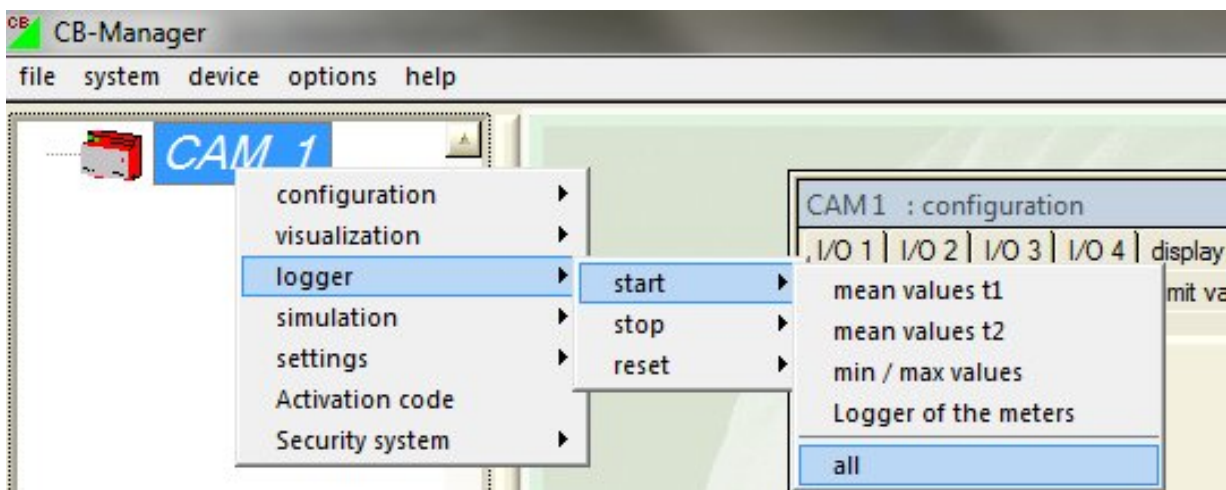

*Note: Alarm, event and operator list can **not** be started, stopped or reset. Lists are always active to prevent manipulations.*

## 5 Connecting the device on-site



Observe **warning 1...7** of the safety precautions!

### 5.1 General warnings



National provisions (e.g. in Germany VDE 0100 "Conditions concerning the erection of heavy current facilities with rated voltages below 1000 V") have to be observed !

### 5.2 Connecting power supply



**For safe operation the device must have a low impedance connection to the protective earth connector. Therefore, check under all circumstances the AC power socket and its wiring !**



Power supply is provided via an IEC power connector on the backside of the device using a three conductor IEC power cord.

**Under all circumstances this cord must provide a connection to protective earth.**

If no connection to protective earth is provided or if protection is disabled by using an extension cord without protective conductor the device may be hazardous.

Connect the device to the power supply using the IEC power cord. Do not switch on the device until voltage and current inputs have been connected.

### 5.3 Connecting current and voltage inputs



- **By connecting measuring circuits dangerous voltages are brought to the inputs and inside the device.**
- **Using non-standard connecting cables may cause dangerous electrical shock. Therefore, use the supplied connection cables only.**
- **To ensure operational safety the device must first be connected to protective earth. This is done via the power supply connector (see 5.2).**
- **Switch off all measurement circuits before connecting them to the device. Make sure that the maximum voltage to earth is not exceeded (300V CATIII, 600V CATII).**

6)

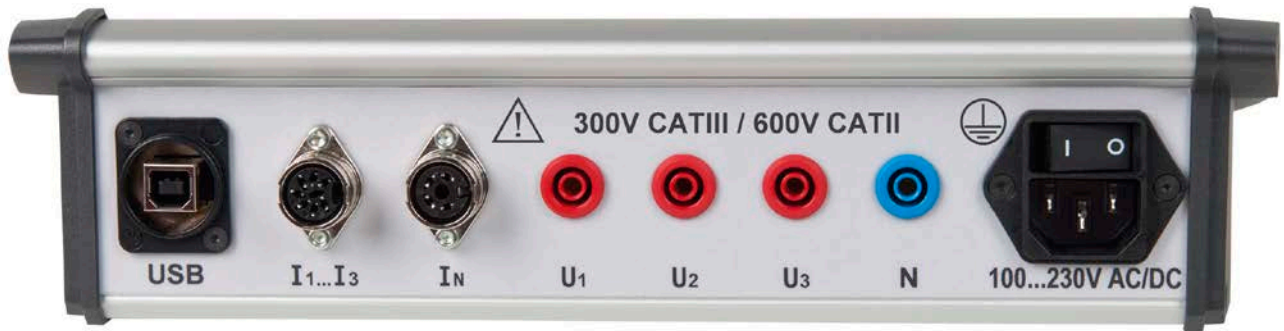

- 1) The USB communication interface is galvanically isolated from all other circuits. Therefore, also during measurement a PC may be connected via the supplied USB cable.
- 2) Connection of the 3-phase Rogowski coil ACP 3003\_3 to measure the **phase currents**  $I_1$ ,  $I_2$  and  $I_3$ . The single-phase coil ACP 3000 cannot be connected here.
- 3) Connection of the single phase Rogowski coil ACP 3000 to measure the **neutral current**  $I_N$ . The three-phase coil ACP 3003\_3 cannot be connected here.
- 4) Connection of voltage inputs
- 5) Power supply connector via IEC power cord ([see 5.2](#))
- 6) Switch for power supply ON / OFF



The wiring of the inputs depends on the configured system.

• **Single phase system**

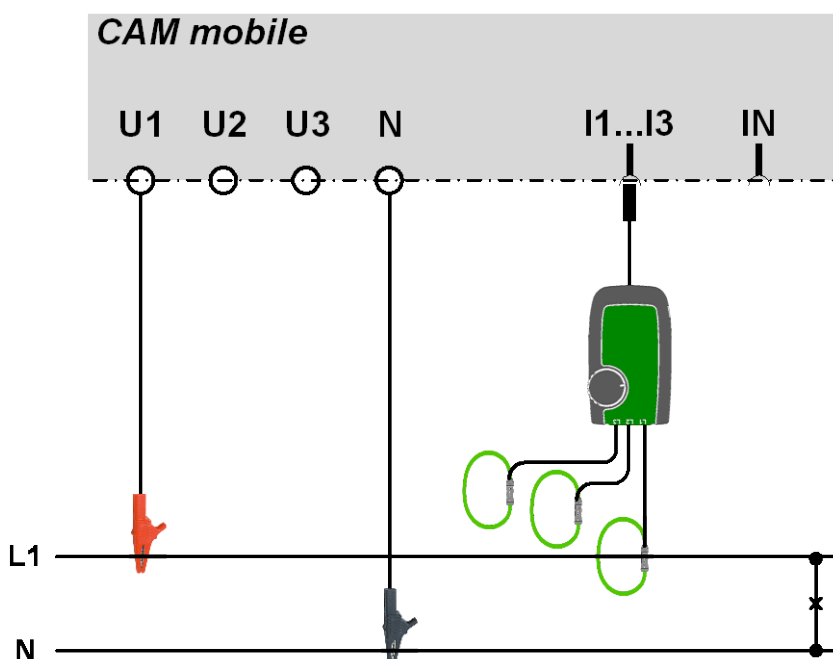

*The coils L2 and L3 of the 3-phase Rogowski coil ACP 3003\_3 are not used*

- 3 phase delta system, balanced load, current measurement L1

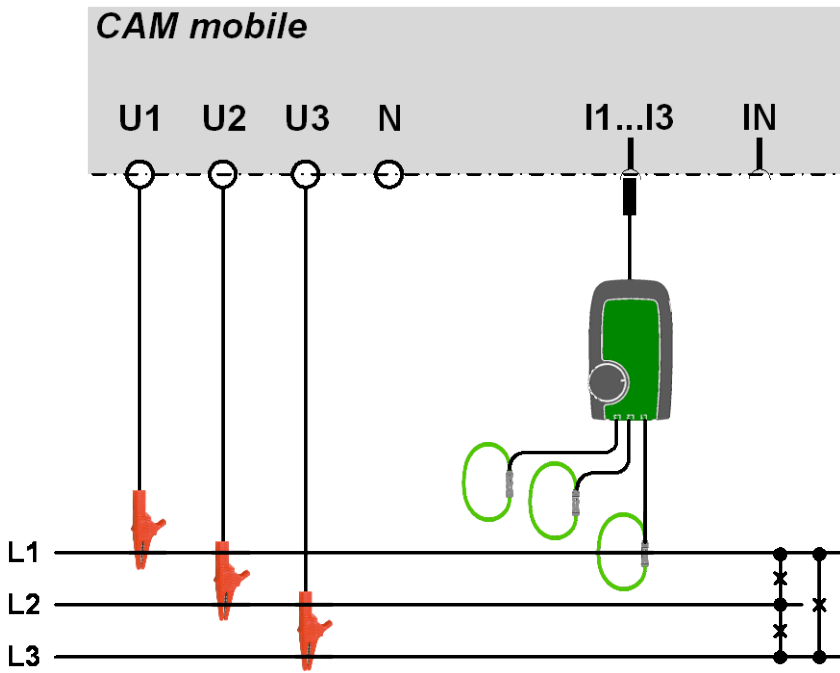

*The coils L2 and L3 of the 3-phase Rogowski coil ACP 3003\_3 are not used*

- 3 phase, 4 wire wye, balanced load, current measurement L1

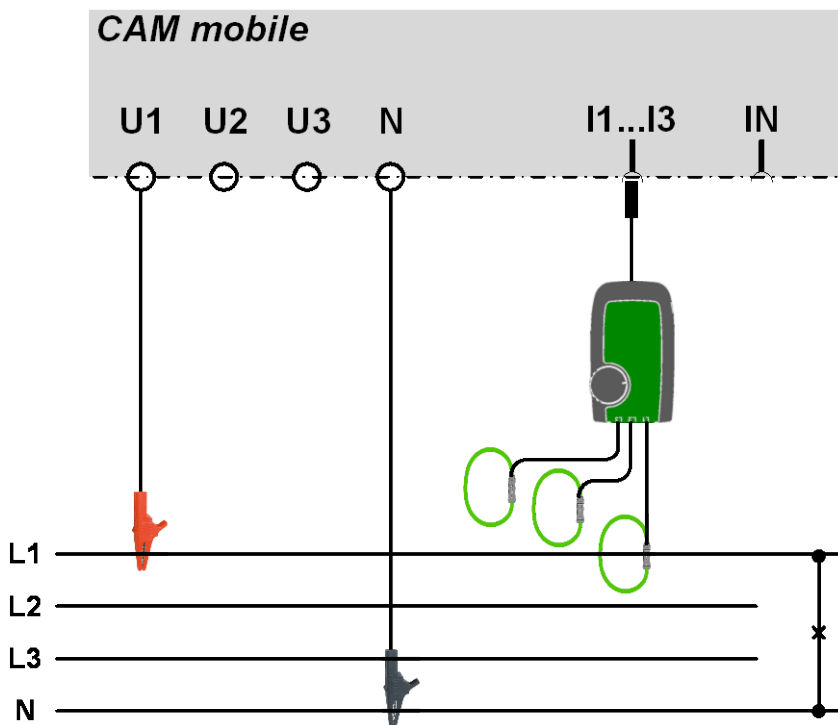

*The coils L2 and L3 of the 3-phase Rogowski coil ACP 3003\_3 are not used*



• 3 phase delta, unbalanced load

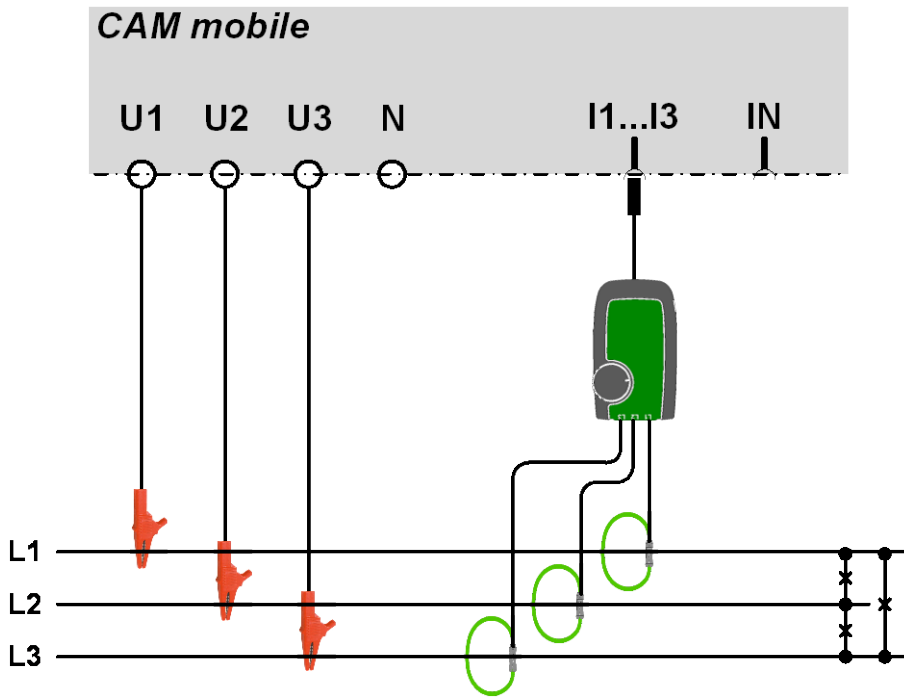

• 3 phase delta, unbalanced load, Aron connection

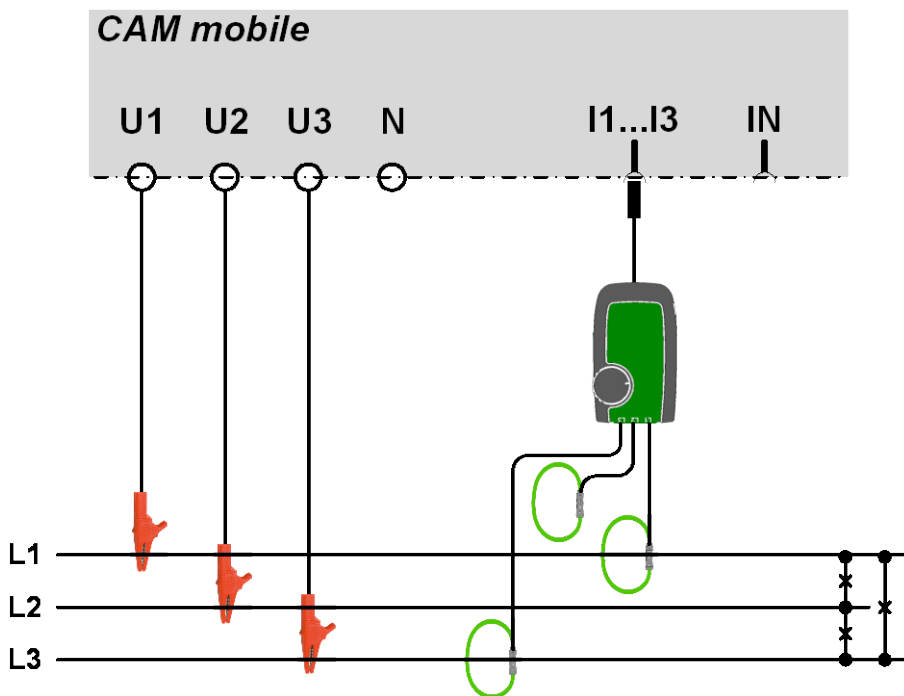

*The coil L2 of the 3-phase Rogowski coil ACP 3003\_3 is not used*

• 3 phase, 4 wire wye, unbalanced load

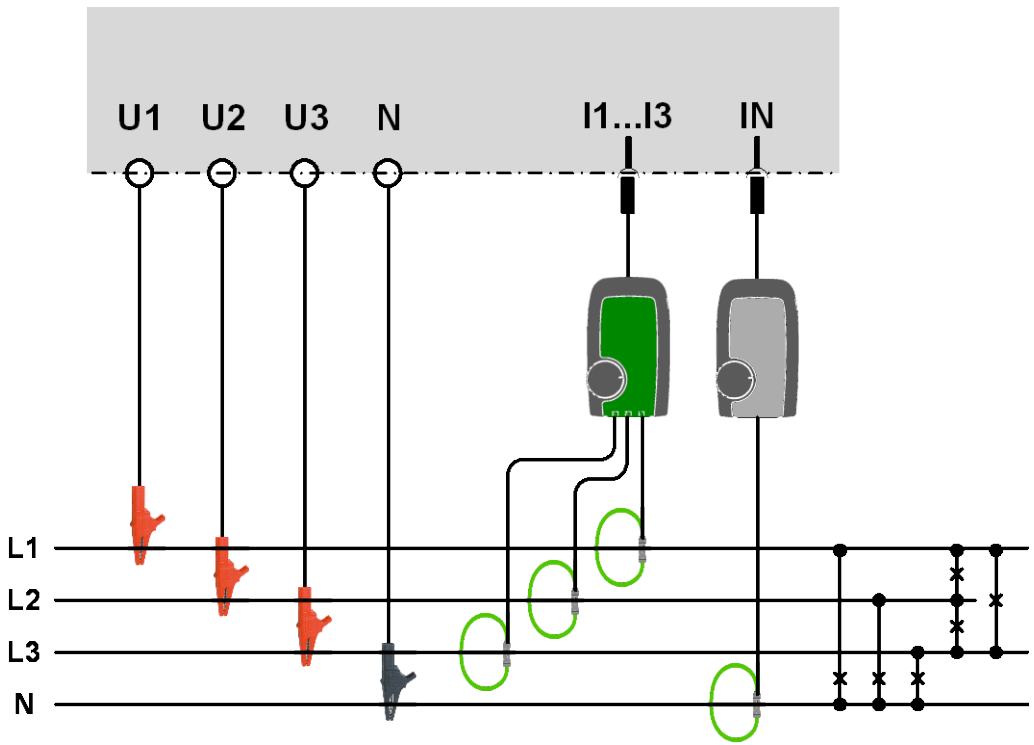

If the single-phase Rogowski coil is not available its connection may be omitted. This will have no influence on measurement or measurement accuracy. Only the neutral current can't be measured and is given with 0.0A.

• Split-phase ("two phase system"), unbalanced load

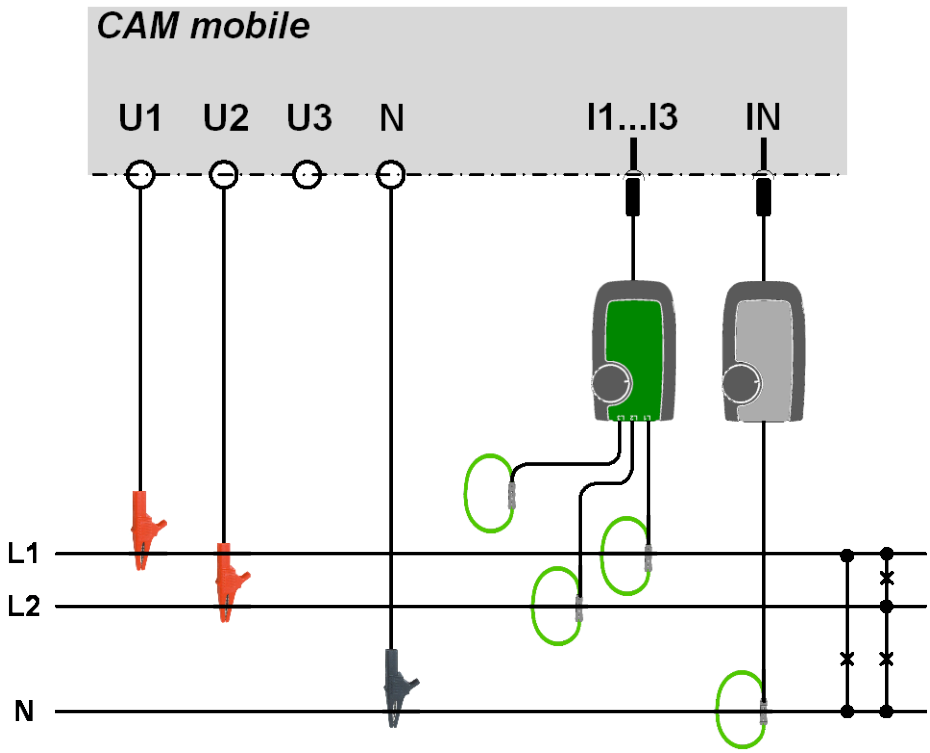

The coil L3 of the 3-phase Rogowski coil ACP 3003\_3 is not used

If the single-phase Rogowski coil is not available its connection may be omitted. This will have no influence on measurement or measurement accuracy. Only the neutral current can't be measured and is given with 0.0A.

## 6 Checking the correct installation

### 6.1 By means of the PC-Software



Voltage (at least 20%  $U_{rated}$ ) and current (at least 2%  $I_{rated}$ ) must be connected

Using the connection check, which is integrated in the visualization of the instantaneous values, the correct connection of the current and voltage inputs may be checked. The phase sequence will be checked, as well as if there are open connections or reversed current connections (which change the direction of the current).

The image below shows open current connections (red description **I1**, **I2**, **I3**). This arises because the individual currents are below 2% of the rated value.

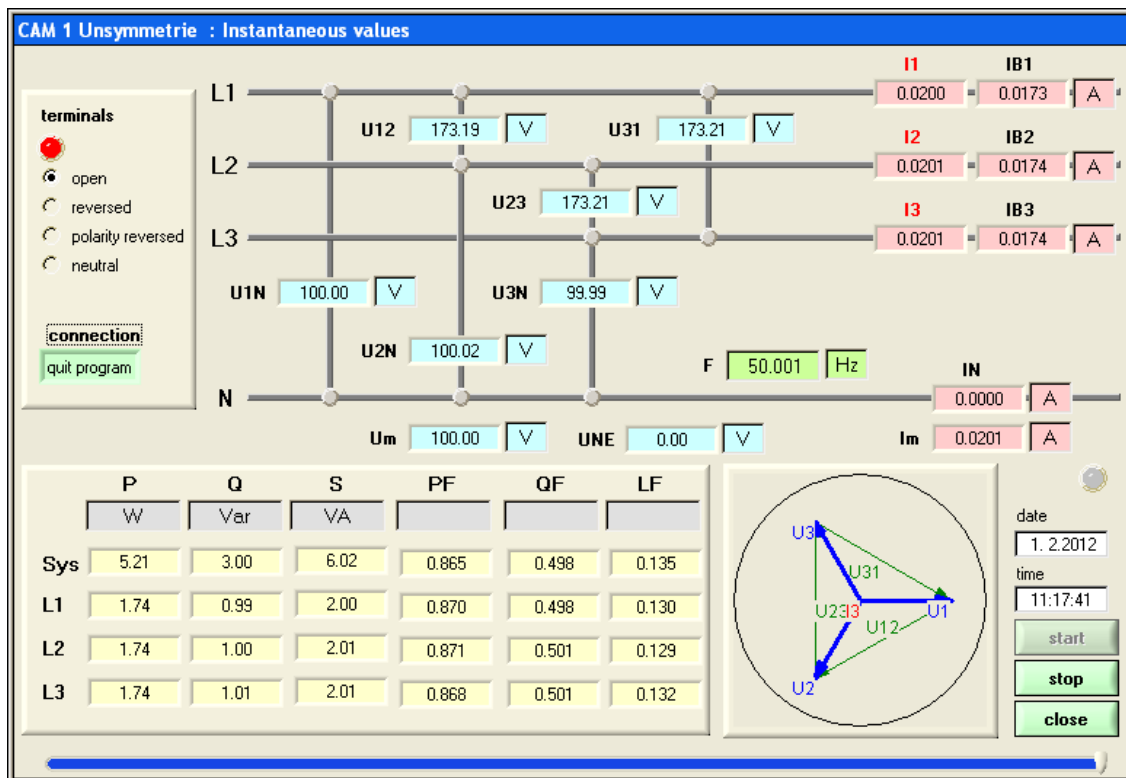

### 6.2 Via measurement display

A simplified connection control is available also via display. See:

- [B4.7 Measurements for wiring control](#)



If the device indicates no voltage, even if voltage should be present, check the fuse of the [lead for voltage measurement](#) (see chapter 2).

## 7 Performing measurements

As soon as the CAM mobile is switched on the device starts to measure and analyze the input quantities in accordance with the configuration. Since the measurement is likely to take place over a longer time period, it is important to check some basic settings, as otherwise the recorded measurement data can not produce the desired result.

➤ **Data logger**

The individual data loggers must be started during parameterization of the device. This is described in the „[Starting the logger](#)“. The state of the individual loggers can be requested only via CB-Manager software using the USB interface.

➤ **Time and date**

Check if time and date are correctly set in the device. See „[Settings of the clock](#)“.

➤ **Min/Max values**

If extreme values should be monitored, it makes sense to reset them after switching on the device, as e.g. minimum values of voltage quantities will be set to 0.0V or the frequency will show the minimum of the allowed frequency range (either 10 or 45Hz). This reset may be performed either by means of the PC software or via display (see „[Display measurements](#)“). The same is valid for meter contents.

## 8 Analysis of recorded data

The analysis of recorded logger data may be performed using the supplied PC software CB-Analyzer. The software may also be downloaded free of charge from our homepage <http://www.camillebauer.com>



The file "Read-me-first.pdf" on the Doku-CD contains all instructions necessary to install the CB-Analyzer software and help for possible problems.

See also [Appendix D2](#)

### Functionality of the CB-Analyzer software

This .NET based software allows reading and analyzing the data of logger and list of the CAM mobile. Data read from the device is saved in a data base. The software is able to handle data of multiple devices at the same time or sequentially.

- ▶ Acquisition of logger and list data of multiple devices
- ▶ Data storage in data base (Access, SQLClient)
- ▶ Different graphical analysis facilities for read data, also across devices
- ▶ Report generation in list or graphic format
- ▶ Selectable time range for report generation
- ▶ Data export as Excel, PDF or WORD file

The CB-Analyzer software provides a comprehensive help functionality, in which the operation of the software is described in detail.

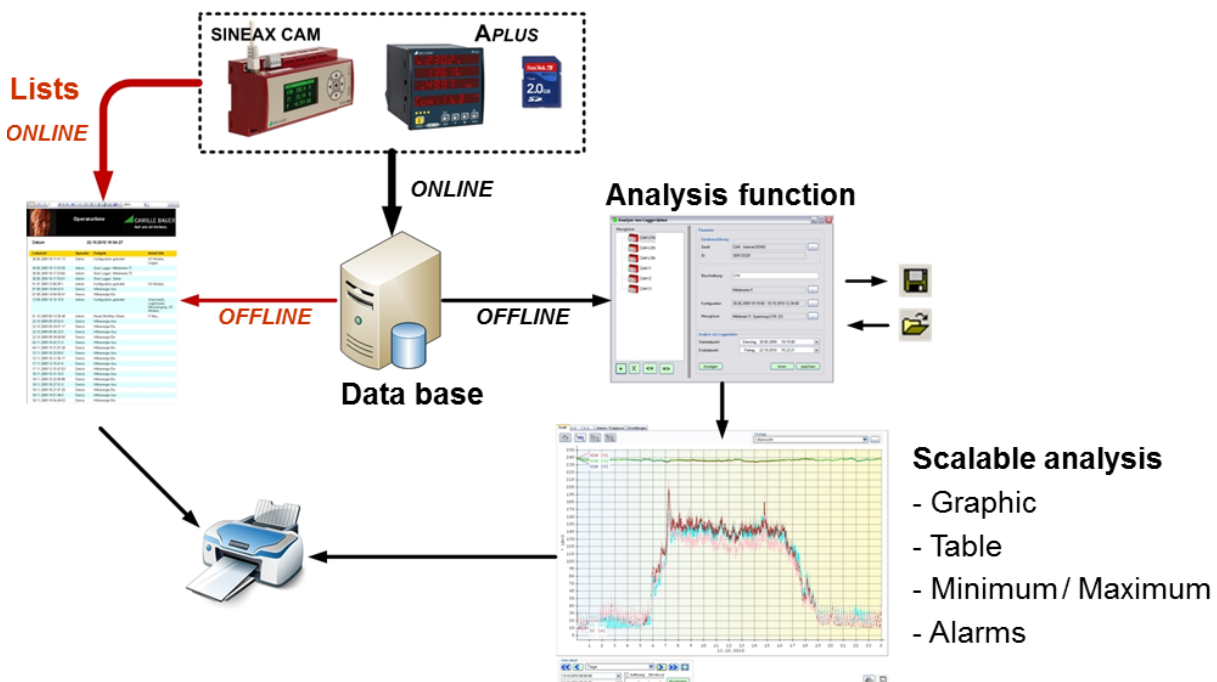

From the structure of the CB-Analyzer it can be seen that logger data must be read in a first step from the device and will then be stored in a data base. For the subsequent data analysis no connection to the device is required.

### Brief introduction

- Start CB-Analyzer (administrator rights are needed)*
- Select data base*

The data base is intended to contain data of multiple devices. However, it's recommended to use a separate data base for each performed measurement.

The selection of the destination data base is done via menu: **data base | settings | edit**. This selection must be made before measurement data is read from the device.

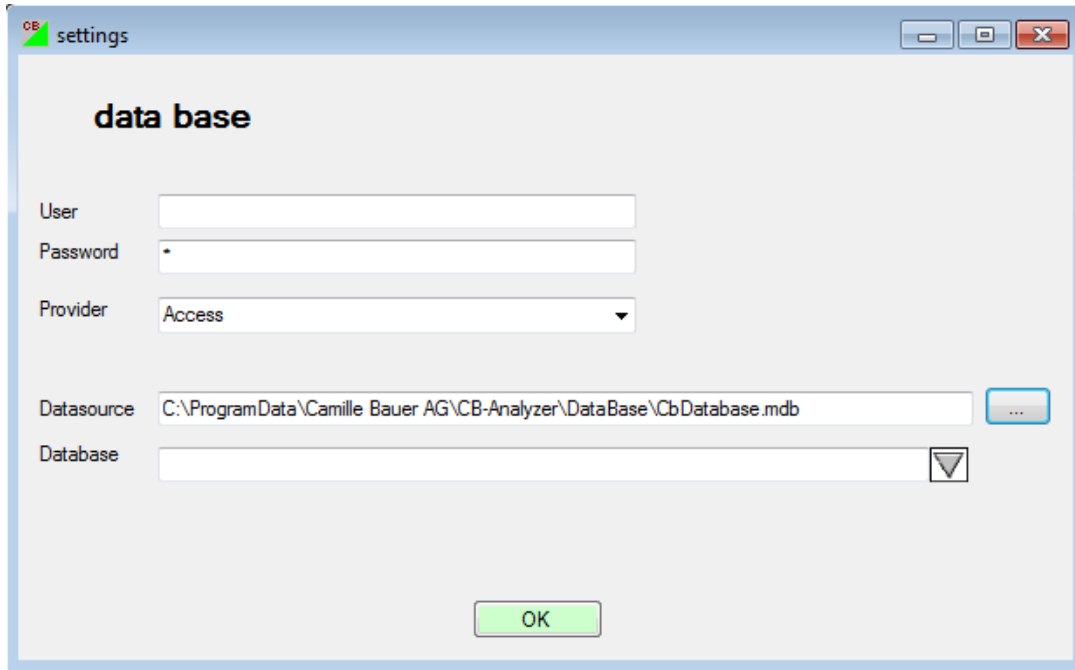

The data base selected under Datasource is used for the data storage.

The free of charge data base has a maximum storage capacity of 2GB. As soon as the data base is full no more new data can be acquired. Then it is time to generate a new data base. This can be done very easy by entering the name of the new data base to generate, e.g.:

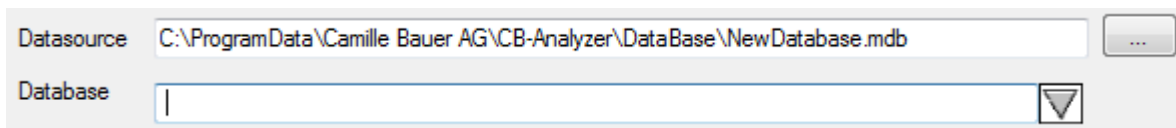

The data base will be generated in the given folder. The data base previously used remains stored and may then be selected again to add further data or to analyze the data already stored.



*It's recommended to use an own data base for each measurement performed. This simplifies analysis and archiving of recorded data and prevents misunderstandings, which may appear due to different device configurations.*

c) Select communication interface USB

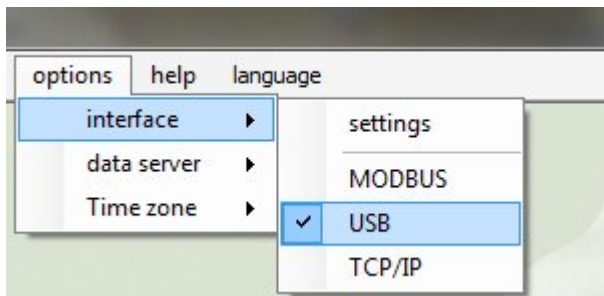

d) Search the connected device

The CAM mobile must be connected to the PC via USB cable and the USB driver of the device has to be installed correctly (see also [D1.3](#)).

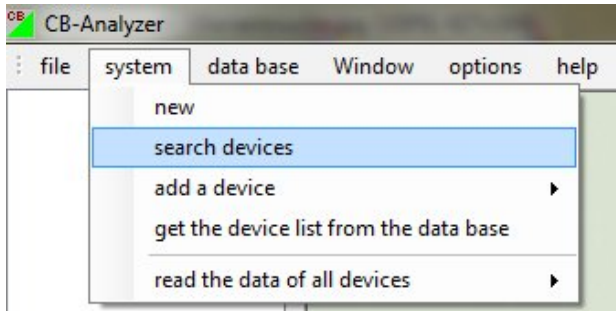

- e) *Read logger data from CAM mobile*  
 (Right click on the device to display the menu)

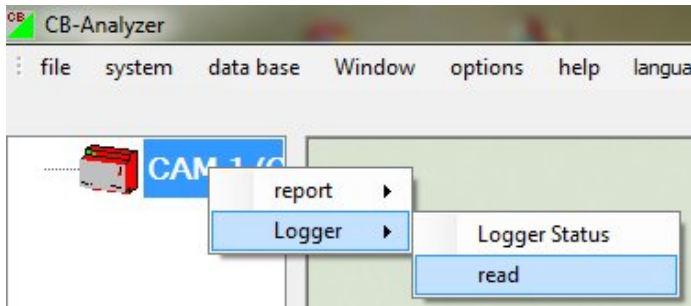

The progress of the reading process is shown with a bar at the bottom:

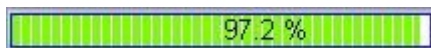

- f) *Display content of alarm, event and operator list*  
 (Right click on the device to display the menu)

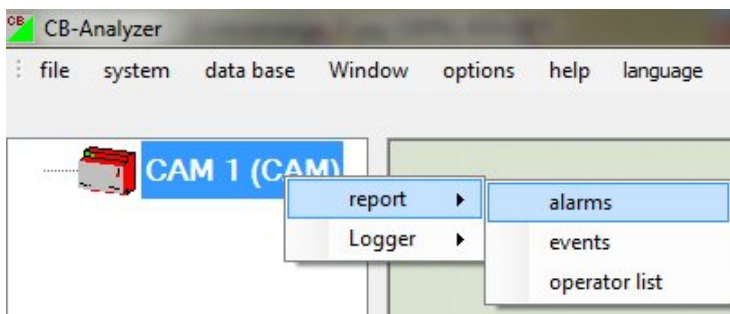

If one or multiple of the report types are shown in gray and can't be selected, then the appropriate list is still empty resp. has not entries yet.

By right clicking on the report a context menu is displayed, which allows to export the list as an Excel, PDF or WORD file.

Lists show the occurrence of events monitored by the appropriate list type in ascending time order. To each event a time stamp is assigned, which is given in UTC or local time (depending on the settings in options | time zone).

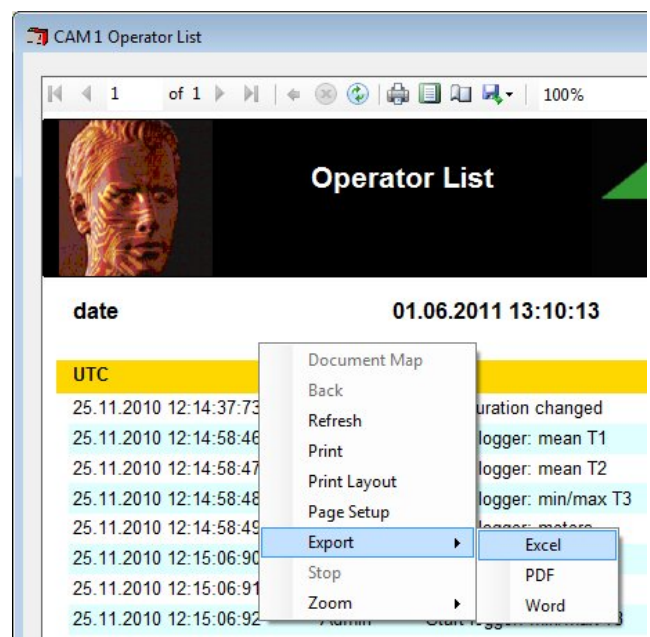

g) Graphical analysis

This analysis is performed using data from the data base. Therefore, the device no longer has to be connected. For the selection of the data base see item b) above.

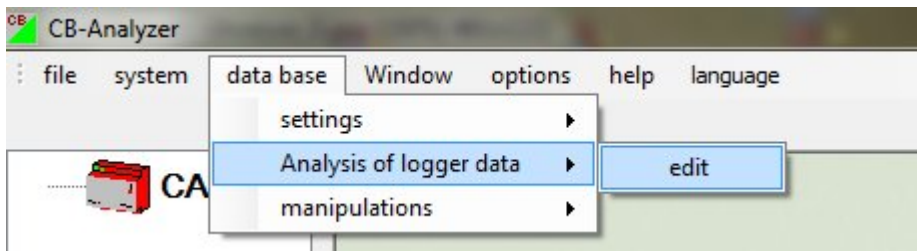

An analysis function may consist of multiple measured quantities, which can be graphically displayed at the same time. Thereby also a calculation of aggregates or differences can be made, e.g. to build the sum of feeders in a transformer station or to calculate the resulting net energy of incoming minus outgoing energy. Once defined an analysis function may be stored for later re-use.

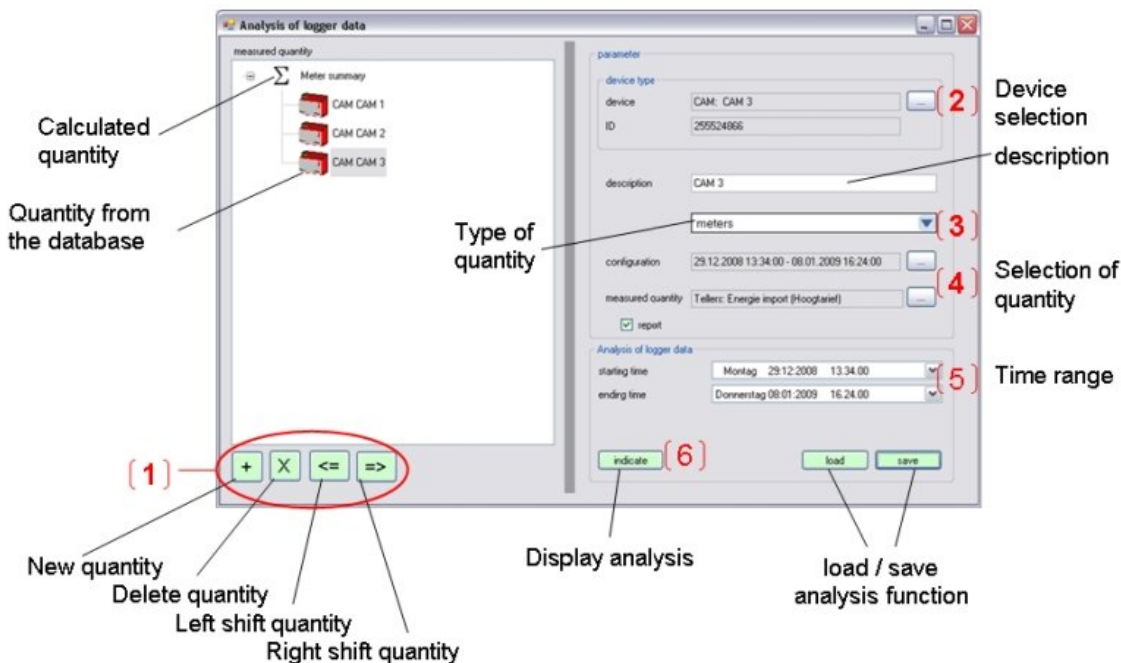

	In the first step quantities must be added to the analysis function. These will be displayed in the measurement list on the left. In the example above the calculation of a sum of three quantities is shown.
1	To do so, the quantities from the database (2nd, 3rd and 4th) must be shifted to the right. The resulting quantity is automatically a sum. A difference is achieved almost the same way. To the first and third quantity a measured quantity is assigned, the quantity in the middle will automatically be the difference.
2	Select measurement device. All devices are selectable, for which measurement data have been stored in the data base. A description can be assigned to the list quantity. Note: The input of a description text must be terminated by <ENTER>, otherwise the text is not accepted.
3	Select quantity type (meter, mean-value t1 or t2, min/max values, alarms)
4	Select measured quantity. Only measured quantities are provided which have entries in the data base. Because the logger may have recordings with different device configurations a pre-selection of a logger sequence with unique configuration must be performed.
5	For the analysis a starting and ending time can be defined.
6	Once the function is completed it can be saved on disk. So next time the same function can be loaded from disk without the need to define the function again. When all quantities from the measured quantities list are defined the graphical analysis can be displayed.



h) Data display handling

Once displayed there are a lot of functions and options to adjust the display to your individual needs. You may zoom-in, adjust the time-scaling, choose a different measurement display form or indicate individual values using the cursor tool.

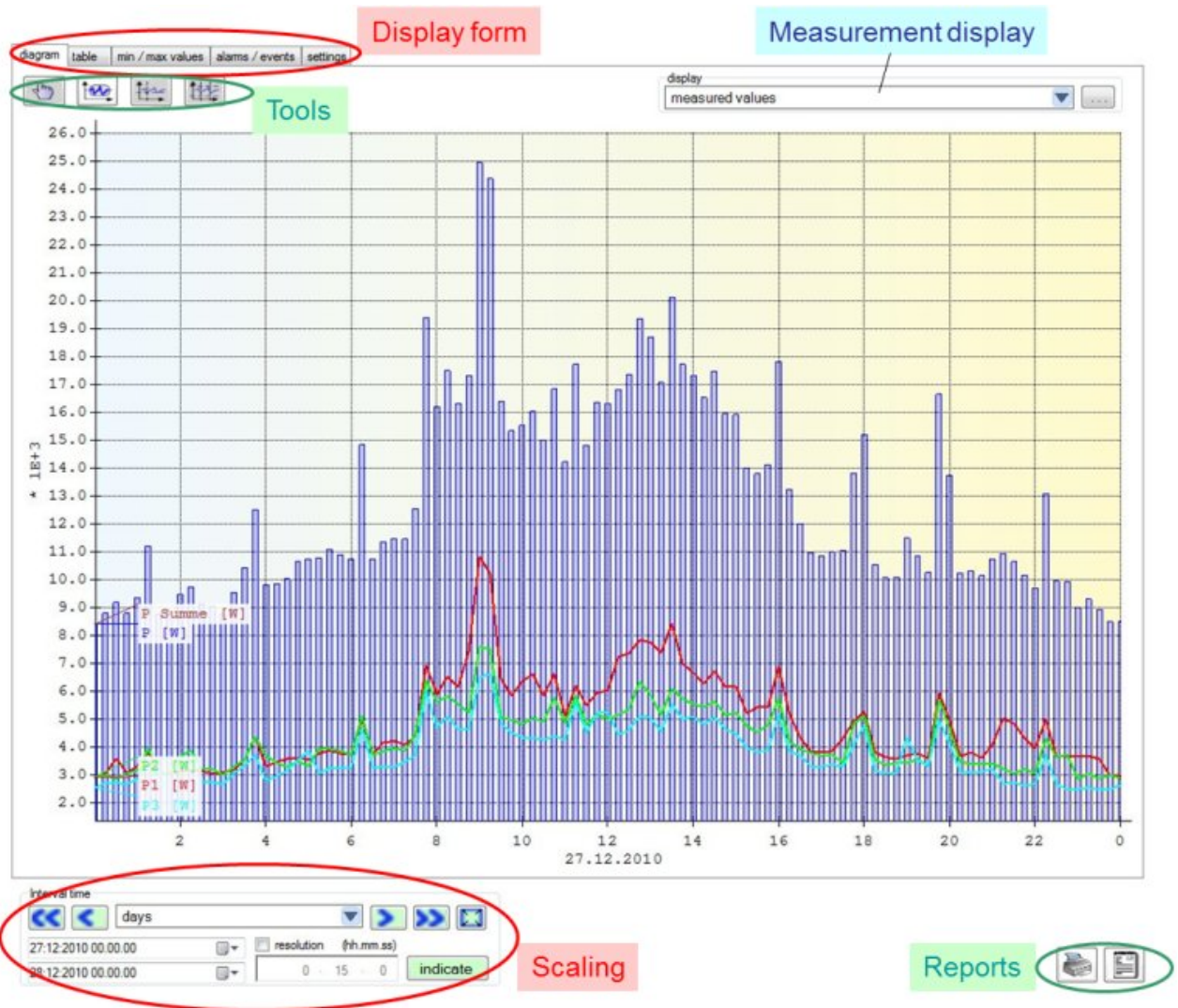

**Display form**

**diagram:** as shown above

**table:** the diagram information in list form. Use <CTRL><C> to copy parts of the table and <CTRL><V> to paste e.g. into Excel.

	UTC	P	1	P1	2	P2	3	P3	4
▶ 1	27.12.2010 00:00:00	8.421	kW	2.922	kW	2.956	kW	2.542	kW
2	27.12.2010 00:15:00	8.805	kW	3.073	kW	3.006	kW	2.725	kW
3	27.12.2010 00:30:00	9.188	kW	3.606	kW	2.858	kW	2.722	kW
4	27.12.2010 00:45:00	8.797	kW	3.080	kW	3.053	kW	2.664	kW
5	27.12.2010 01:00:00	9.367	kW	3.321	kW	3.173	kW	2.872	kW

**min/max values:** For every quantity the absolute minimum and maximum value within the selected time range is shown

**alarms / events:** If existing, events occurred in the selected time range will be displayed in table form.

**settings:** allows changing display parameters

## Tools



The **hand tool** is used to shift the graphic by means of the mouse.

The **zoom tool** allows selecting the area of interest within the diagram.

The **cursor tool** allows displaying the individual values of each graph.

The **double cursor tool** allows to set a cursor (SHIFT) and then to use the second cursor to make comparisons.

## Measurement display

Depending on the time-scaling there can be ten-thousands of data points to be displayed, which takes a lot of time. The type of measurement display can therefore be selected:

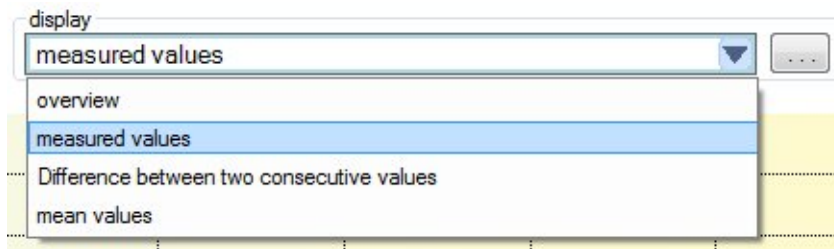

**overview:** (default) The time needed is decreased by displaying the minimum, the maximum and the mean-value of multiple points only. This setting should be activated during the search for parts of interest. It should be not activated during final analysis.

**measured values:** All measurements within the selected time range will be displayed

**Difference between two consecutive values:** Can be used to visualize meter increments

**mean values:** The amount of existing measurements will be reduced by creating mean-values (see: resolution in scaling)



Allows performing a pre-selection for meter and mean-value display

## Scaling

Here the displayed **time range** can be set. Also a fix scaling, like days, weeks or months may be selected. There are also buttons for shift the time scale left or right or to show all (reset of previous zoom-operations).

**Resolution** (hh:mm:ss) corresponds to the distance in time between the displayed measurements. This time can be prolonged to e.g. reduce the amount of displayed data by creating mean-values.

## Reports



A list of all the values, including minimum and maximum, for the selected time range will be created. These data may be printed or exported as Excel, PDF or WORD file. Don't miss to expand the desired data before exporting.



Prints the measurement chart for the selected time range.

## 9 Service and maintenance

### 9.1 Protection of data integrity

The CAM mobile supports security mechanism, which serve to prevent manipulation or undesired modifications of device data.

Data stored in the device can be changed or reset via USB interface or via the keys on the device itself. To limit these possibilities in the field a security system may be activated in the device using the CB-Manager (default: not activated). For the definition of user rights an administrator login is required in the software. The factory setting is:

User: *admin*  
Password: *admin*

 The administrator password may be changed, but a reset is possible in our factory only !

### 9.2 Calibration and new adjustment

Each device is adjusted and checked before delivery. The condition as supplied to the customer is measured and stored in electronic form.

The uncertainty of measurement devices may be altered during normal operation if, for example, the specified ambient conditions are not met. If desired, in our factory a calibration can be performed, including a new adjustment if necessary, to assure the accuracy of the device.

### 9.3 Cleaning

The display and the operating keys should be cleaned in regular intervals. Use a dry or slightly moist cloth for this.



#### **Damage due to detergents**

Detergents may not only affect the clearness of the display but also can damage the device. Therefore, do not use detergents.

### 9.4 Battery

The device contains a battery for buffering the internal clock. It cannot be changed by the user. The replacement can be done at the factory only.

### 9.5 Disposal

The product must be disposed in compliance with local regulations. This particularly applies to the built-in battery.

# 10 Technical data

## Measurement input

Rated frequency:	50 ... 60 Hz measurement TRMS: Up to 63 <sup>rd</sup> harmonic
Measurement category:	≤ 300 V CATIII, ≤ 600 V CATII

## Current measurement (via Rogowski coils)

[See Appendix C3](#)

## Voltage measurement

Rated voltage:	57.7 ... 400 V <sub>LN</sub> , 100 ... 693 V <sub>LL</sub>
Overriding max.	600 V, 1040 V (sinusoidal)
Consumption:	≤ U <sup>2</sup> / 3 MΩ per phase
Input impedance:	3 MΩ per phase
Overload:	480 V <sub>LN</sub> , 832 V <sub>LL</sub> continuous 600 V <sub>LN</sub> , 1040 V <sub>LL</sub> , 10 x 10 s, Interval 10 s 800 V <sub>LN</sub> , 1386 V <sub>LL</sub> , 10 x 1 s, Interval 10 s

## System

Single-phase	1L
Split Phase	2L
3-wire system, balanced load	3Lb
3-wire system, unbalanced load	3Lu
3-wire system, unbalanced load (Aron)	3Lu.A
4-wire system, balanced load	4Lb
4-wire system, unbalanced load	4Lu
4-wire system, unbalanced load (Open-Y)	4Lu.O

## Basic accuracy under reference conditions acc. IEC/EN 60 688

The additional error of the Rogowski coils is not included in the following information.

Voltage:	± 0.1% FS <sup>a)</sup>
Current:	± 0.1% FS <sup>a)</sup>
Power:	± 0.2% FS <sup>b)</sup>
Power factor:	± 0.1°
Frequency:	± 0.01 Hz
Unbalance U:	± 0.2%
Harmonics:	± 0.5%
THD Voltage:	± 0.5%
TDD Current:	± 0.5%
Active energy	
Direct connection:	Cl. 1 / EN 62 053-21
Active energy	
Transformer connection:	Cl. 2 / EN 62 053-21
Reactive energy:	Cl. 2 / EN 62 053-23

## Influence quantities and permissible variations

According to IEC/EN 60 688

## Additional error due to system configuration

Neutral N not connected (3Lu, 3Lu.A):	
Voltage	0.1% of reading
Power	0.1% of reading
Energy	Voltage influence x 2, Angle error x 2
Power factor	0.1°

a) FS: Maximum value of input configuration (Full Scale)

b) FS: FS-Voltage x FS-Current

## Interrupted input signal:

Voltage	0.2% FS
Current	0.2% FS
Power	0.5% FS
Energy	Basic acc. x 3
Power factor	0.1°

## Measurement with fixed frequency:

General	± Basic acc. x (f <sub>config</sub> -f <sub>real</sub> ) [Hz] x10
Unbalance U	± 1.5% until ± 0.5 Hz
Harmonics	± 1.5% until ± 0.5 Hz
THD, TDD	± 2.0% until ± 0.5 Hz

## Zero suppression, Range limitations

PF	1, if S <sub>x</sub> < 0.2% range-S
QF, LF	0, if S <sub>x</sub> < 0.2% range-S
Current	0, if I <sub>x</sub> < 0.1% range-I
unb. U	0, if ØU < 5.0% range-U
H-U, THD-U	0, if H1 < 5.0% range-U
H, THD, TDD, unb. U	0, if ΔF longer than 1s > 5 Hz/s
f	45 ... 65 Hz or 10 ... 70 Hz

range-U for voltage input configuration L-L sec. max.:

≤ 132 V	Range <u>range-U</u> = 76.2 V <sub>LN</sub> , 132 V <sub>LL</sub>
≤ 264 V	Range <u>range-U</u> = 152.4 V <sub>LN</sub> , 264 V <sub>LL</sub>
≤ 528 V	Range <u>range-U</u> = 304.8 V <sub>LN</sub> , 528 V <sub>LL</sub>
≤ 1040 V	Range <u>range-U</u> = 600 V <sub>LN</sub> , 1040 V <sub>LL</sub>

Measurement calculation acc. DIN 40 110 including 4-quadrant measurement.

## Interface

### USB connection (USB Mini-B, 5 contacts)

Function:	Configuration, Meas. acquisition
Protocol:	USB 2.0

### Power supply

AC, 50 – 400 Hz:	100 ... 230 V ± 15%
Consumption:	≤ 10 VA
System voltage drop:	< 400 ms (230 V AC) < 80 ms (115 V AC)

### Limit module (Software function)

64 limit values for monitoring measurement limits	
Limit for ON state:	programmable
Limit for OFF state:	programmable

### Logic module (Software function)

32 logic functions to combine logical states of limit values, other logic functions or default values. Outputs can trigger entries to alarm or event list.

### Measurement time t

Basic measurement quantities	
Measurement interval:	programmable, 1...1024 cycles (averaging time RMS values)
Measurement time t:	2 x Meas. interval + 17 ms
After the time t measurements are ready to be read via USB interface or may be further processed internally.	

## Safety

Protection class: I acc. EN61010-1, connection with protective earth of the fixed installation  
Pollution degree: 2

## Ambient conditions, general information

Operating temp.: – 10 till 15 till 30 till + 55 °C  
Storage temp.: – 25 till + 70 °C  
Temperature influence: 0,5 x basic accuracy per 10 K  
Long term drift: 0,2 x basic accuracy per year  
Others: Usage group II according IEC/EN 60 688  
Relative humidity: < 95% no condensation  
Altitude: ≤ 2000 m max.  
Indoor use statement!

## Internal clock (RTC)

Function: Time reference, operating hours counter  
Accuracy: ± 2 minutes / Month (15 till 30°C), trimmable via PC-Software CB-Manager

## Mechanical attributes

Design: Aluminum desktop enclosure with plastic handles  
Protection: IP40 (housing), IP20 (connectors)  
Dimensions: 294 x 185,2 x 74,2 mm  
Weight: 1,37 kg

## Applied standards and regulations

IEC/EN 61 010-1 Safety regulations for electrical measuring, control and laboratory equipment  
IEC/EN 60 688 Electrical measuring transducers for converting AC electrical variables into analog and digital signals  
DIN 40 110 AC quantities  
IEC/EN 60 068-2-1/-2/-3/-6/-27: Ambient tests  
IEC/EN 61000-6-2/-6-4: Electromagnetic compatibility (EMC), Generic standards for industrial environment  
IEC/EN 61 326 Electrical equipment for measurement, control and laboratory use – EMC requirements

# Appendix

## A Description of measured quantities

### Used abbreviations

- 1L Single phase system
- 2L Split phase; system with 2 phases and center tap
- 3Lb 3-wire system with balanced load
- 3Lu 3-wire system with unbalanced load
- 3Lu.A 3-wire system with unbalanced load, Aron connection (only 2 currents connected)
- 4Lb 4-wire system with balanced load
- 4Lu 4-wire system with unbalanced load
- 4Lu.O 4-wire system with unbalanced load, Open-Y (reduced voltage connection)

### A1 Basic measurements

These measured quantities are determined using the configured measurement time (1...1024 cycles). If a measurement is available depends on the selected system.

Depending on the measured quantity also minimum and maximum values are determined and non-volatile stored with timestamp. These values may be reset by the user via the display unit or via the configuration interface.

Measurement	present	max	min	1L	2L	3Lb	3Lu	3Lu.A	4Lb	4Lu.O	4Lu
Voltage U	•	•	•	√	√				√		
Voltage U <sub>1N</sub>	•	•	•		√					√	√
Voltage U <sub>2N</sub>	•	•	•		√					√	√
Voltage U <sub>3N</sub>	•	•	•							√	√
Voltage U <sub>12</sub>	•	•	•			√	√	√		√	√
Voltage U <sub>23</sub>	•	•	•			√	√	√		√	√
Voltage U <sub>31</sub>	•	•	•			√	√	√		√	√
Zero displacement voltage U <sub>NE</sub>	•	•									√
Current I	•	•		√		√			√		
Current I1	•	•			√		√	√		√	√
Current I2	•	•			√		√	√		√	√
Current I3	•	•					√	√		√	√
Bimetal current 1...60min. IB	•	•		√		√			√		
Bimetal current 1...60min. IB1	•	•			√		√	√		√	√
Bimetal current 1...60min. IB2	•	•			√		√	√		√	√
Bimetal current 1...60min. IB3	•	•					√	√		√	√
Neutral current I <sub>N</sub>	•	•								√	√
Active power P	•	•		√	√	√	√	√	√	√	√
Active power P1	•	•			√					√	√
Active power P2	•	•			√					√	√
Active power P3	•	•								√	√
Reactive power Q	•	•		√	√	√	√	√	√	√	√
Reactive power Q1	•	•			√					√	√
Reactive power Q2	•	•			√					√	√
Reactive power Q3	•	•								√	√
Apparent power S	•	•		√	√	√	√	√	√	√	√
Apparent power S1	•	•			√					√	√
Apparent power S2	•	•			√					√	√
Apparent power S3	•	•								√	√
Frequency F	•	•	•	√	√	√	√	√	√	√	√

Measurement	present	max	min	1L	2L	3Lb	3Lu	3Lu.A	4Lb	4Lu.O	4Lu
Power factor PF	•			✓	✓	✓	✓	✓	✓	✓	✓
Power factor PF1	•				✓					✓	✓
Power factor PF2	•				✓					✓	✓
Power factor PF3	•									✓	✓
PF incoming inductive			•	✓	✓	✓	✓	✓	✓	✓	✓
PF incoming capacitive			•	✓	✓	✓	✓	✓	✓	✓	✓
PF outgoing inductive			•	✓	✓	✓	✓	✓	✓	✓	✓
PF outgoing capacitive			•	✓	✓	✓	✓	✓	✓	✓	✓
Reactive power factor QF	•			✓	✓	✓	✓	✓	✓	✓	✓
Reactive power factor QF1	•				✓					✓	✓
Reactive power factor QF2	•				✓					✓	✓
Reactive power factor QF3	•									✓	✓
Load factor LF	•			✓	✓	✓	✓	✓	✓	✓	✓
Load factor LF1	•				✓					✓	✓
Load factor LF2	•				✓					✓	✓
Load factor LF3	•									✓	✓
$U_{mean}=(U1N+U2N)/2$	•				✓						
$U_{mean}=(U1N+U2N+U3N)/3$	•									✓	✓
$U_{mean}=(U12+U23+U31)/3$	•						✓	✓			
$I_{mean}=(I1+I2)/2$	•				✓						
$I_{mean}=(I1+I2+I3)/3$	•						✓	✓		✓	✓

### Power factors

The **power factor PF** gives the relation between active and apparent power. The PF has a range of -1...0...+1, where the sign gives the direction of energy flow.

The **load factor LF** is a quantity derived from the PF, which allows making a statement about the load type. Only this way it's possible to measure a range like 0.5 capacitive ... 1 ... 0.5 inductive in a non-ambiguous way.

The **reactive power factor QF** gives the relation between reactive and apparent power.

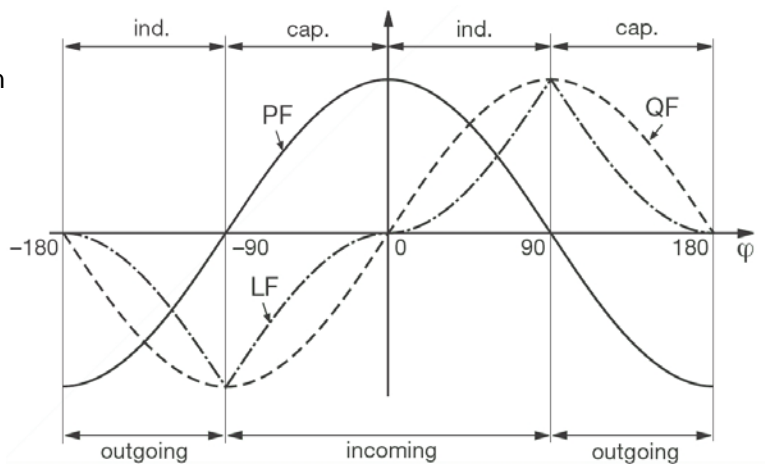

## Zero displacement voltage $U_{NE}$

Starting from the generating system with star point E (which is normally earthed), the star point (N) on load side is shifted in case of unbalanced load. The zero displacement voltage between E and N may be determined by a vectorial addition of the voltage vectors of the three phases:

$$U_{NE} = - (U_{1N} + U_{2N} + U_{3N}) / 3$$

A displacement voltage may also occur due to harmonics of order 3, 9, 15, 21 etc., because the dedicated currents add in the neutral wire.

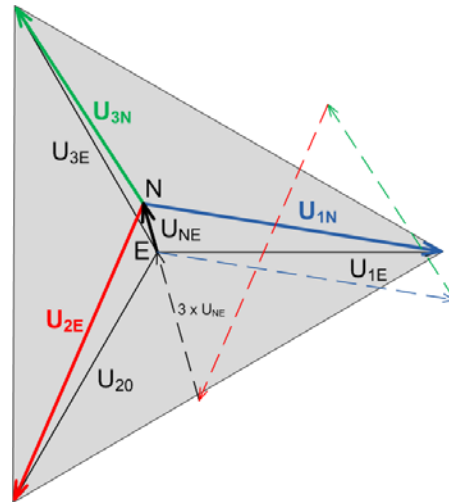

## Earth fault monitoring in IT systems

Via the determination of the zero displacement voltage it's possible to detect a first earth fault in an unearthed IT system. To do so, the device is configured for measurement in a 4-wire system with unbalanced load and the neutral connector is connected to earth. In case of a single phase earth fault there is a resulting zero displacement voltage of  $U_{LL} / \sqrt{3}$ . The alarming may be done e.g. by means of a relay output.

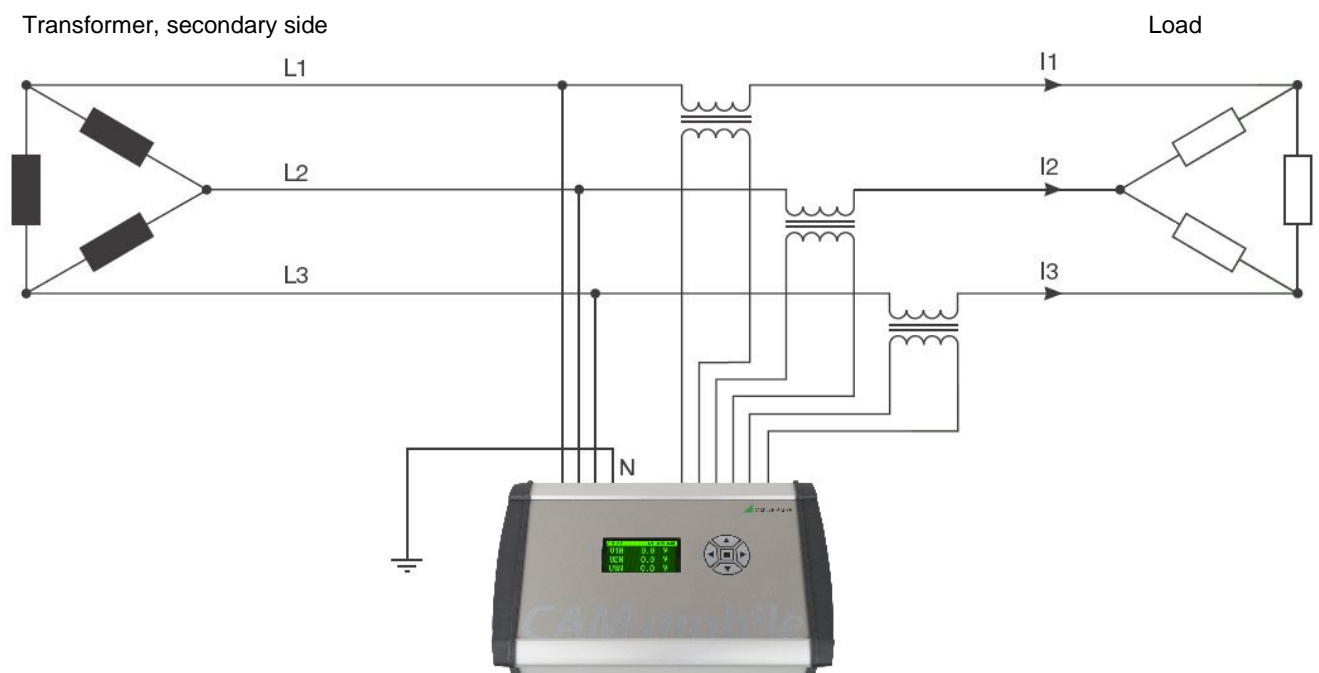

Because in case of a fault the voltage triangle formed by the three phases does not change the voltage and current measurements as well as the system power values will be still measured and displayed correctly. Also the meters carry on to work as expected.

The method is suited to detect a fault condition during normal operation. A declination of the isolation resistance may not be detected this way.



## A2 Harmonic analysis

Measurement	present	max	1L	2L	3Lb	3Lu	3Lu.A	4Lb	4Lu.O	4Lu
THD Voltage U1N/U	●	●	√	√				√	√	√
THD Voltage U2N	●	●	√	√					√	√
THD Voltage U3N	●	●							√	√
THD Voltage U12	●	●			√	√	√			
THD Voltage U23	●	●			√	√	√			
THD Voltage U31	●	●			√	√	√			
TDD Current I1/I	●	●	√	√	√	√	√	√	√	√
TDD Current I2	●	●		√		√	√		√	√
TDD Current I3	●	●				√	√		√	√
Harmonic contents 2nd...50th U1N/U	●	●	√	√				√	√	√
Harmonic contents 2nd...50th U2N	●	●		√					√	√
Harmonic contents 2nd...50th U3N	●	●							√	√
Harmonic contents 2nd...50th U12	●	●			√	√	√			
Harmonic contents 2nd...50th U23	●	●			√	√	√			
Harmonic contents 2nd...50th U31	●	●			√	√	√			
Harmonic contents 2nd...50th I1/I	●	●	√	√	√	√	√	√	√	√
Harmonic contents 2nd...50th I2	●	●		√		√	√		√	√
Harmonic contents 2nd...50th I3	●	●				√	√		√	√

### Harmonics

Harmonics are multiple of the fundamental resp. system frequency. They arise if non-linear loads, such as RPM regulated drives, rectifiers, thyristor controlled systems or fluorescent lamps are present in the power system. Thus undesired side effects occur, such as additional thermal stress to operational resources or electrical mains, which lead to an advanced aging or even damage. Also the reliability of sensitive loads can be affected and unexplainable disturbances may occur. In industrial networks the image of the harmonics gives good information about the kind of loads connected.

### TDD (Total Demand Distortion)

In the CAM mobile the complete harmonic content of the currents is shown as Total Demand Distortion, briefly TDD. This value is scaled to the rated current resp. rated power, rather than using the instantaneous value of the current as a reference. Only this way it's possible to estimate the influence of the current harmonics on the connected equipment correctly.

### Maximum values

The maximum values of the harmonic analysis arise from the monitoring of THD and TDD. The maximum values of individual harmonics are not monitored separately, but are stored if a maximum value of THD or TDD is detected. The image of the maximum harmonics therefore always corresponds to the dedicated THD resp. TDD.

### A3 Mean values and trend

Measured quantity		Present	Trend	max	min
<b>Averaging time t1</b>					
Quantity 1	1s...60min.	•	•	•	•
Quantity 2	1s...60min.	•	•	•	•
Quantity 3	1s...60min.	•	•	•	•
Quantity 4	1s...60min.	•	•	•	•
Quantity 5	1s...60min.	•	•	•	•
Quantity 6	1s...60min.	•	•	•	•
Quantity 7	1s...60min.	•	•	•	•
Quantity 8	1s...60min.	•	•	•	•
Quantity 9	1s...60min.	•	•	•	•
Quantity 10	1s...60min.	•	•	•	•
Quantity 11	1s...60min.	•	•	•	•
Quantity 12	1s...60min.	•	•	•	•
<b>Averaging time t2</b>					
Quantity 1	1s...60min.	•	•	•	•
Quantity 2	1s...60min.	•	•	•	•
Quantity 3	1s...60min.	•	•	•	•
Quantity 4	1s...60min.	•	•	•	•
Quantity 5	1s...60min.	•	•	•	•
Quantity 6	1s...60min.	•	•	•	•
Quantity 7	1s...60min.	•	•	•	•
Quantity 8	1s...60min.	•	•	•	•
Quantity 9	1s...60min.	•	•	•	•
Quantity 10	1s...60min.	•	•	•	•
Quantity 11	1s...60min.	•	•	•	•
Quantity 12	1s...60min.	•	•	•	•

#### Calculating the mean-values

The mean value calculation is performed via integration of the measured instantaneous values over a configurable averaging interval. The interval time may be selected in the range from one second up to one hour. Possible interim values are set the way that a multiple of it is equal to a minute or an hour. The interval times t1 and t2 may be different.

#### Synchronization

For the synchronization of the averaging intervals the internal clock is used.

#### Trend

The estimated final value (trend) of mean values is determined by weighted addition of measurements of the past and the present interval. It serves for early detection of a possible exceeding of a given maximum value. This can then be avoided, e.g. by switching off an active load.

## A4 Meters

Measured quantity	1L	2L	3Lb	3Lu	3Lu.A	4Lb	4Lu.O	4Lu
Active energy incoming, high tariff	•	•	•	•	•	•	•	•
Active energy outgoing, high tariff	•	•	•	•	•	•	•	•
Reactive energy inductive, high tariff	•	•	•	•	•	•	•	•
Reactive energy capacitive, high tariff	•	•	•	•	•	•	•	•
Reactive energy incoming, high tariff	•	•	•	•	•	•	•	•
Reactive energy outgoing, high tariff	•	•	•	•	•	•	•	•
Active energy incoming, low tariff	•	•	•	•	•	•	•	•
Active energy outgoing, low tariff	•	•	•	•	•	•	•	•
Reactive energy inductive, low tariff	•	•	•	•	•	•	•	•
Reactive energy capacitive, low tariff	•	•	•	•	•	•	•	•
Reactive energy incoming, low tariff	•	•	•	•	•	•	•	•
Reactive energy outgoing, low tariff	•	•	•	•	•	•	•	•

### Standard meters

The meters for active and reactive energy of the system are always active. Because no input for tariff switching is available low tariff meters are inactive

## B Graphic display

The optional graphic display is intended for on-site visualization of measurement data, lists and alarms of the SINEAX CAM. The operation of the display is performed by means of the keys. Using the keys the user may acknowledge alarms or extreme values as well.

The parameterization of the graphic display and the assembly of user specific measurement displays are done using the **CB-Manager** Software. But settings like contrast or display language may also be performed by means of the operating keys.

### Content

<b>B Graphic display</b> .....	<b>36</b>
<b>B1 Display structure and operation</b> .....	<b>37</b>
<b>B2 Settings</b> .....	<b>38</b>
B2.1 Settings of the display .....	38
B2.2 Settings of the interface .....	38
B2.3 Settings of the clock .....	39
<b>B3 Security system</b> .....	<b>40</b>
<b>B4 Display measurements</b> .....	<b>41</b>
B4.1 Customer specific measurement displays .....	41
B4.2 Measurement display of system quantities .....	42
B4.3 Measurement display of harmonics.....	43
B4.4 Display meter contents .....	44
B4.5 Measurements of I/O's and relays .....	44
B4.6 Measurement display of mean values .....	45
B4.7 Measurements for wiring control .....	45
<b>B5 Alarms</b> .....	<b>46</b>
<b>B6 Lists</b> .....	<b>47</b>
<b>B7 Logger</b> .....	<b>50</b>
<b>B8 Menu overview</b> .....	<b>51</b>

## B1 Display structure and operation

### Generally

When first switching on the device the main menu is displayed. On every further start-up the last displayed image before the power-down is shown. There may be exceptions after a reconfiguration of the device via interface, if the displayed information is no longer available.

When changing the display window there may be a waiting time, which is symbolized by displaying a sand glass. This way it can be prevented that out-of-date data is displayed.



### Selection menus



- ◀:⏪ = Back to previous menu
- :↵ = Execute the selected line
- ▲: Shift the selection up

**Scroll position:** If displayed, the list contains more entries than can be displayed at the same time

- ▼: Shift the selection up

**Menu description**  
as a navigation help

**Operating menu**  
(possible functions)



The operation of the display is performed using the keys. The symbols displayed in the operating menu correspond to the symbols on the keys. The assigned function is stated behind the colon.

### Overview of the used operating functions

	Back to the previous displayed menu		Positioning using the cursor keys		Positioning upwards or downwards
	Perform selection		Adopt selected item		Display page ±
	Perform selection, press ■ longer (>1s)		Alarm acknowledge, press ■ longer (>1s)		Reset selected item, press ■ longer (>1s)
	Go to next parameter		Harmonic ±		Adjust value ±
	Enlarge / downsize: Number of measurements, scaling				

## B2 Settings



### select a parameter group

Invoke the line *settings* in the main menu. This line will be visible only if the selection is shifted downwards. In the menu settings go to the line with the desired parameter group using the keys ▲ and ▼. Then invoke the corresponding parameter page by pressing the key ■.

### B2.1 Settings of the display



### parameter selection

Position to the parameter which should be modified using the keys ▲ and ▼. Press ■ to see the value start flashing. Subsequent the possible functions of the operating menu change.



### modifying parameters

The parameter can now be adjusted to the desired value using the keys ▲ and ▼. After pressing the key ■ again the value will be adopted and stops flashing. The operating menu changes back. Repeat the procedure for other parameters.

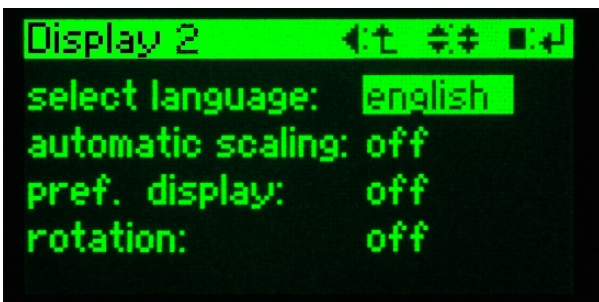

### display 2

Preference display and rotation are features of the customer specific measurement displays (see page 8). Auto scaling adjusts the representation to the measurement value. This way and if input signals are low more digits are shown, but maybe are not significant.

### B2.2 Settings of the interface

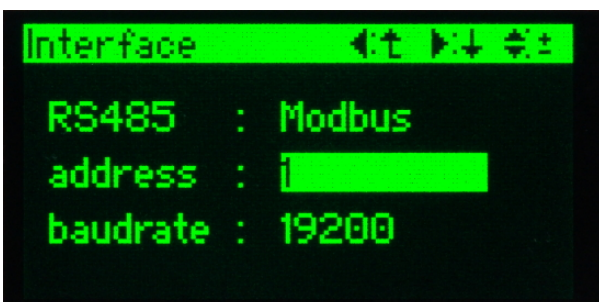

### adjust Modbus parameters

Following the procedure used in B2.1 to modify the parameters device address and the baud rate to your needs.

*Attention: All devices connected to the Modbus must have the same baud rate.*

### B2.3 Settings of the clock

The CAM mobile has an internal clock, which is used as a time reference for alarms, events, progression of measurements and so on. Due to the daylight saving time used in many regions the time must to be set forward once a year and backward once a year as well. Especially when setting back the time information gets lost, because data for this time is acquired twice but can be stored only once.

To handle this problem the CAM mobile uses internally UTC time only (see below). The user can set a time offset, which performs a static time shift to the local time. This way time references shown on the display are correct. In countries where a change to daylight saving time is performed, the offset of normally one hour has to be adjusted at the beginning and at the end of the daylight saving time.

#### ATTENTION !

A modification of the **UTC time** has a serious impact on logger and lists. If e.g. the time is shifted into the past, no entry can be made into the logger or lists until the UTC time is at least equal to the one used for the last entry. Only this way the consistency of the already recorded data can be guaranteed. The only alternative is the complete reset of all logger and list data. Therefore the following warning is displayed before the clock data:

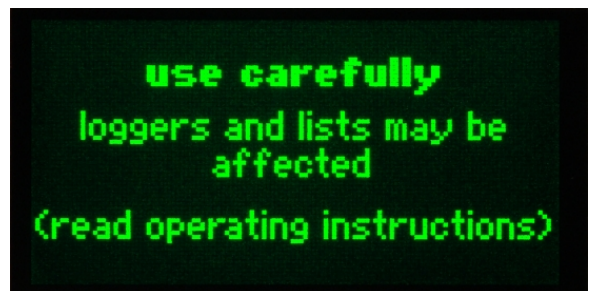

However, a modification of the **local time offset** is harmless.

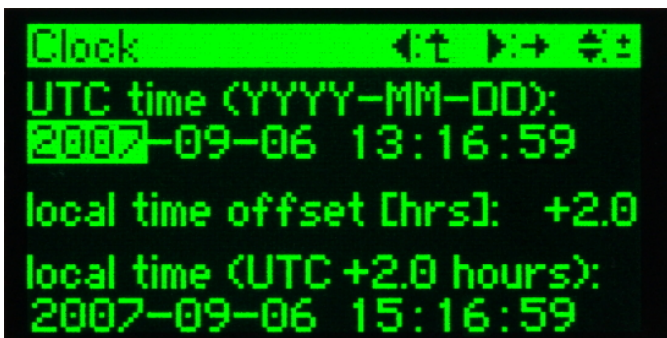

#### changing of parameters

There is no need for a special modification mode. The flashing value can be modified directly using the keys ▲ and ▼. To go on to the next parameter use ►. The take over of the data is not performed before the return to the menu settings.

---

#### UTC (Universal Time Coordinated)

Sometimes UTC is called world time as well. The reference corresponds to the Greenwich Mean Time (GMT). The time zones of the world nowadays are all referenced with an offset to UTC. UTC time doesn't use time shifts, which may occur due to a change to daylight saving time.

**Example:** In Switzerland the CET (Central European Time) is valid, which has an offset of +1[h] to UTC. But during have of the year the CEST (Central European Summer Time) is used, which has an offset of +2[h] to the UTC time used in the SINEAX CAM.

### B3 Security system

The device supports a security system which allows selectively assigning rights to different users. Thereby rights for the changing of measurement or configuration data or the simulation of I/O data may be granted.

The granting of the rights is performed using the CB-Manager software during the configuration of the device. Along with the administrator up to three users are supported. To each user the administrator assigns a user name and a password and the individual rights. Then the system is activated. The protection then is secured for access via CB-Manager software as well as via display.

For the display the following functions may be protected using the security system:

- Reset of meters and extreme values
- Settings of display, interface and clock

To perform one of this functions a user must be logged in and he has to own the necessary rights. If no user is logged in or the necessary rights are not granted the following error message appears:

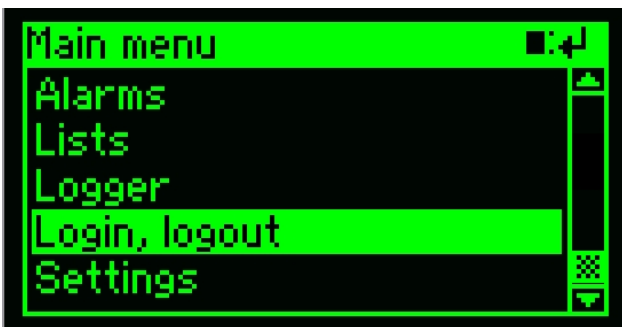
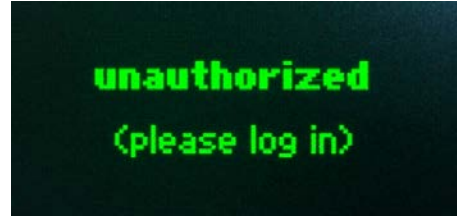

#### entrance via main menu

The login is not requested when trying to perform a protected function. A user has to log in prior via main menu. Subsequent he is able to perform all functions enabled for him until he logs out or the device is switched off.



#### Login, logout

When a user or administrator logs in the present user is automatically logged out. Only when log in the input of a password is required. To perform the desired operation position to the appropriate line using ▲ and ▼ and press the key ■. The displayed process, here the logout of the administrator, will take effect.



#### enter the password

For the input of the password position to the characters and press shortly ■. Special characters can be masked using \* and will not be tested then. To finish the entry of the password press the key ■ for a longer time (>1s).



## B4 Display measurements

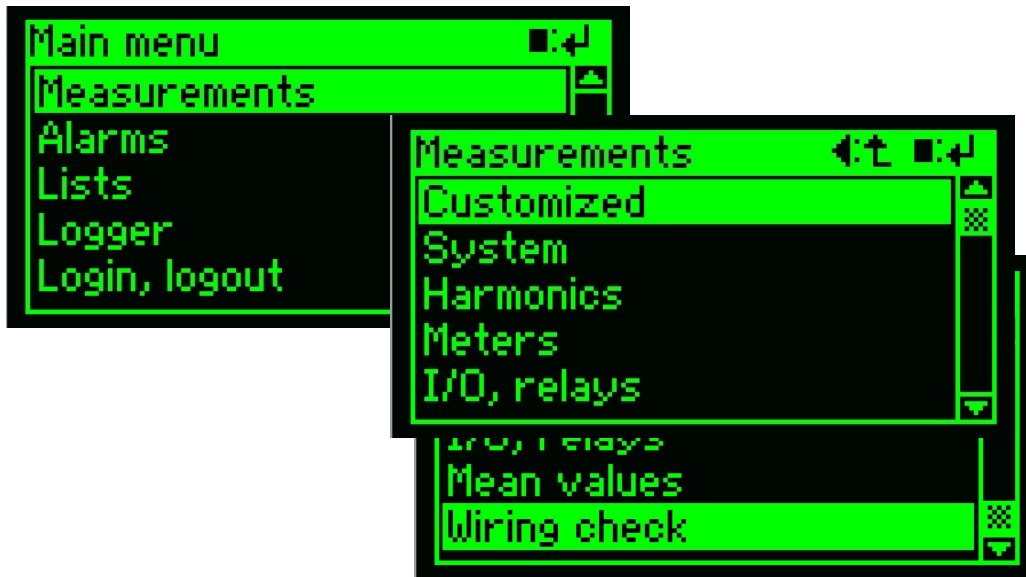

The Measurements menu has more entries as directly can be displayed.

Via main menu the menu measurements may be invoked. There the following data are available:

**Customized:** Free assembled measurement data, arranged by the user using the CB-Manager software.

**System:** Instantaneous values of the system and their extreme values with reset facility.

**Harmonics:** Individual harmonics, THD and TDD of voltage and current as well as their maximum values with reset facility.

**Meters:** All acquired meter contents of the measured system and the I/O's.

**I/O, relays:** Measurements resp. states of the I/O's and relays.

**Mean values:** Trend and last value of the mean-values with interval time  $t_1 / t_2$ , with extreme values and reset facility.

**Wiring check:** Measurements for checking the correct wiring of the device.

### B4.1 Customer specific measurement displays

Because the user doesn't need all of the provided measurement data, it's possible to make an almost free assembling of up to 20 display screens using the CB-Manager software. Existing pages of other measurement displays may be used or free combinations of single measurements can be made.

This way it should be possible, that the user works only with the customized measurement display. Other pages are then required for special functions only. The representation of these data is not shown here in detail, because it's identical to other existing measurement displays.

**Preference display:** If activated, one of the customer specific pages will be displayed automatically after a configurable time without user interaction. This way the appearance of the device is always similar.

**Rotation:** If activated, all customer specific pages will be displayed one after the other. The rotation interval is configurable.

Preference display and rotation may be switched on and off via the display settings. But these functions can not be used at the same time.

## B4.2 Measurement display of system quantities

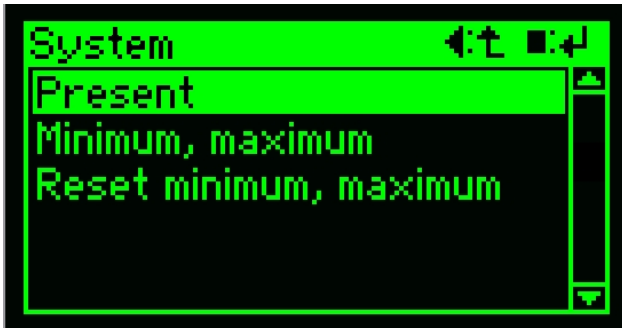

**Present:** Contains the instantaneous values of the system

**Minimum, maximum:** Shows all acquired minimum and maximum values with timestamp

**Reset minimum, maximum:** Allows to selectively reset the acquired extreme values

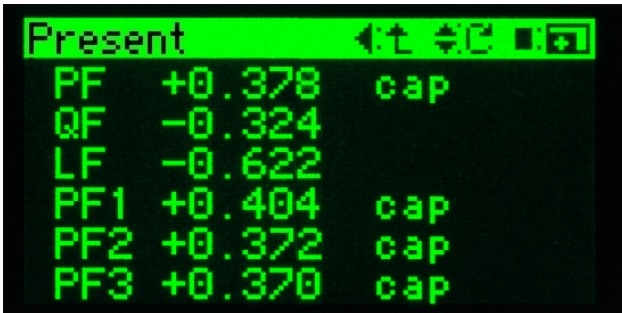

### Present

This predefined assembling of measurements consists of multiple pages. The representation can be switched from big (3 values) to small (6 values), or vice versa, using the key ■. To select the next or the previous page use the keys ▲ and ▼.



### Minimum, maximum

For selected measurements acquired maximum and, if applicable, minimum values can be displayed with timestamp (time of occurrence).

The selection of the page to display may be done using ▲ and ▼.



### Reset min., max.

For all acquired extreme values or selectable kinds of measurand, minimum and maximum values may be reset by pressing ■ for a longer time (>1s).

*Note: For measurands like the slave pointer IB it may take several minutes until a new value is stored.*

The displayable measurements depend on the configured system (type of connection). The displayed measurement combinations therefore may be different

according to the application. Details for the timestamp (time of occurrence) used here may be found in the chapter settings of the clock.

### B4.3 Measurement display of harmonics

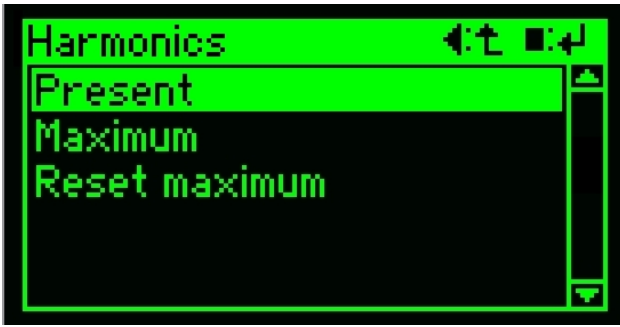

**Present:** Contains the present harmonic contents as well as THD and TDD

**Maximum:** Contains the acquired maximum values with timestamp

**Reset maximum:** Allows to selectively reset the maximum values

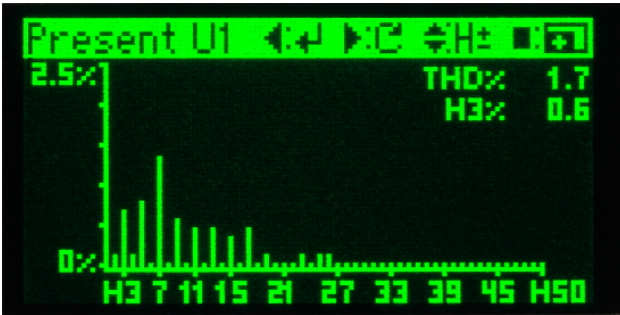

#### Present

Each page shows a graphical overview of the present harmonic contents (U or I) and the value for one individual harmonic. The displayed harmonic may be changed using ▲ and ▼. Scaling may be adjusted using ■. To select the next measurand use the key ►.



#### Maximum

Each page shows a maximum THD (resp. TDD) with timestamp, the corresponding harmonic contents as well as the value for one individual harmonic. The displayed harmonic may be changed using ▲ and ▼. Scaling may be adjusted using ■. To select the next measurand use the key ►.

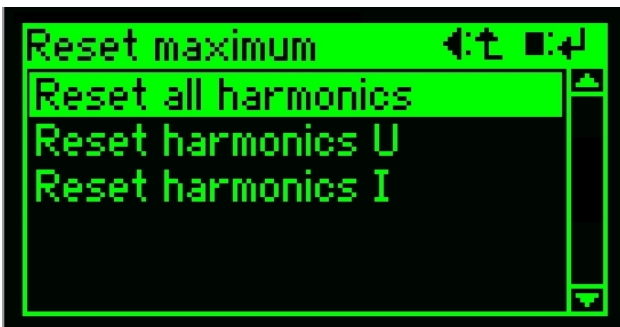

#### Reset maximum

Maximum values of THD (voltage) resp. TDD (current) along with their corresponding harmonics may be reset by pressing ■ for a longer time (>1s). This can be done for all values or selectively for the harmonics of voltage or current only.

*Note:* When monitoring the maximum values of the harmonics, in fact the maximum value of the THD resp. TDD is supervised. If a new maximum value is detected, it is stored along

with the corresponding harmonic contents. This way it's assured that the stored data belong together and represent an image of the real world.

#### B4.4 Display meter contents

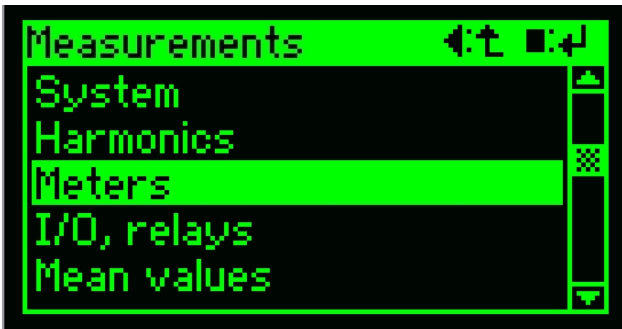

Meter contents are acquired for both the measured system as well as for analog inputs. For digital inputs it takes place only if the inputs are configured as meter inputs.



#### Meters

For each meter the contents for high tariff (HT) and for low tariff (LT) are displayed. If the tariff switching is not active for the meters, no value will be shown for LT. The selection of the meter is performed via ▲ and ▼. A long pressing of the key ■ (>1s) resets the displayed meter contents.

#### B4.5 Measurements of I/O's and relays



For each channel of analog output modules the output value and the channel text is displayed.



For each channel of digital input or output modules the output value and the channel text is displayed.



For each channel of analog input modules the scaled measurement and the channel text is displayed.

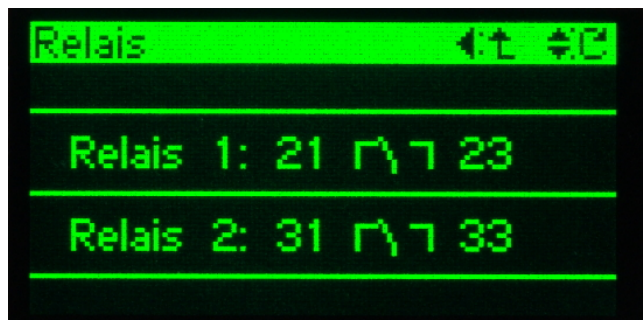

For each relay output the present position of the switching contact is shown.

For each existing I/O module one page is shown, followed by the view of the relay states.

The selection of the display page is done using the keys ▲ and ▼.

## B4.6 Measurement display of mean values

Mean values may be acquired with two different interval times  $t_1$  and  $t_2$ . The corresponding measured quantities are freely configurable. Therefore also the

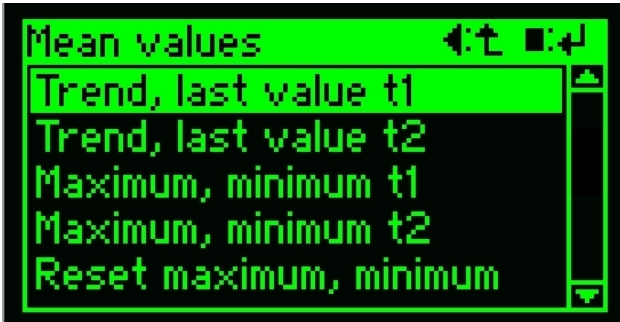

## B4.7 Measurements for wiring control



appropriate measurement displays are variable. Up to 12 different pages may be displayed. The selection is performed using the keys ▲ and ▼.

**Trend, last value  $t_1$  /  $t_2$ :** Last calculated mean value and the trend of this measurement

**Maximum, minimum  $t_1$  /  $t_2$  :** The extreme values of the acquired mean values with timestamp

**Reset maximum, minimum:** Allows to selectively reset the extreme values

### Mean values $t_1$ / $t_2$

For each selected measurand the last acquired mean value as well as the trend value is shown.

Monitoring of trend values by means of limit values makes sense especially for power quantities.

### Maximum, minimum $t_1$ / $t_2$

For each configured mean value quantity the maximum and the minimum value with timestamp (time of occurrence) is shown.

*Details about the timestamp may be found in the chapter settings of the clock.*

### Reset max., min.

For all acquired values or selectively only for parts extreme values can be reset by pressing ■ for a longer time (>1s).

*Note: Depending on the interval time  $t_1$  resp.  $t_2$  it may take hours until a new extreme value is stored.*

The wiring check shows measurements for voltage and current of all phases and the direction of energy flow of the currents.

If all voltages have almost similar values and the energy flow direction of the currents is equal it may be assumed that the wiring has been performed correctly.

## B5 Alarms

Via the logic module of the SINEAX CAM complex contexts may be monitored. Out of them alarms can be generated, which are shown on the graphic display and can be acknowledged via the keys.



### alarm reporting

The occurrence of an alarm is reported by a blinking bell symbol in the upper left corner of the display, no matter which display page is active at the moment. The information which alarm is really active can be found via the alarm display.

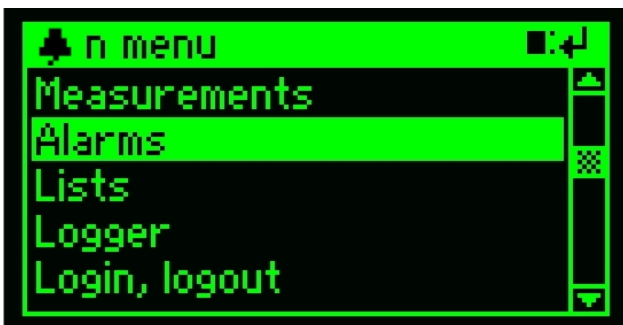

### alarm display

Via the menu item alarms of the main menu one may proceed to the alarm list. There the states of all monitored alarms are displayed, no matter if they are active or not.

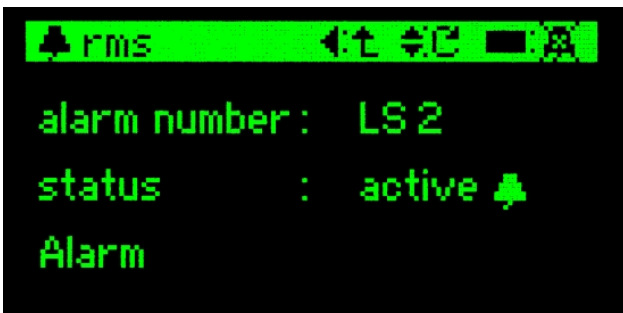

### alarm states

The alarm display gives the information if a specific monitored alarm is active or not. The alarm number refers to the appropriate logic function. The status shows if the alarm is active, active acknowledged or inactive.

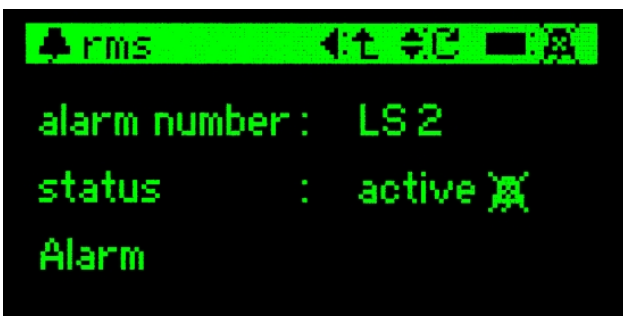

### acknowledgement of alarms

By pressing the key ■ for a longer time (>1s) the displayed alarm will be acknowledged. It changes its status to active acknowledged. If the alarm symbol in the upper left corner changes accordingly, then there is no further alarm in the alarm state.

The option **Lists** offers the possibility to record the occurrence, the acknowledgement and the setting of alarms with time reference in chronological and correct order.

If the security system has been activated, also the user who has acknowledged an alarm will be recorded.

## B6 Lists

The **Lists** allows performing a chronological recording of events, alarms or system messages. At a later time it's possible to understand and analyze each state change of the power system and each intervention to the device in a correct time sequence.

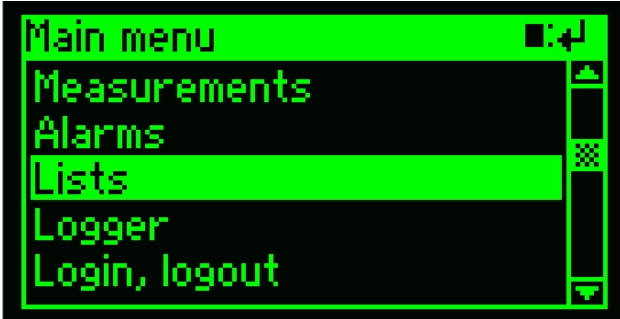

### Alarm list / event list

The list contains all alarms / events, which has been intended for recording in the alarm resp. event list using the logic module. For the entries the texts will be used which have been defined in the logic module for the appropriate state change.



All recordings can be displayed on request, with time stamp and dedicated text. If the security system has been activated for specific displays also the involved user is available. This way it's e.g. possible to see later on which user has acknowledged an alarm.

### **access to list information**

Via the menu item lists in the main menu the sub-menu lists can be entered. If no lists are active or the option is not implemented, then after the selection of the menu item lists no further action is performed.

### **available information**

For each list entries with time stamp and explanatory text may be requested. There is no list display if still no entries exist or if the list hasn't been configured for use, e.g. if the number of events to record is 0.

The following will be recorded with time stamp:

- \* *The occurrence of the event*
- \* *The determination of the event*

A possible acknowledgement of alarms will be recorded in the operator list. Events are not subject for acknowledgement.

### **list entry**

The time stamp shows the time of the occurrence of the event. The user defined text gives further information about the event. Also given is the number of the associated logic function. By means of the keys ▲ and ▼ it's possible to browse the existing entries.

## Operator list

This list contains all the events which are caused by a user interaction or a specific system event.

The monitored events are listed below. All texts are predefined and can't be modified by the user.

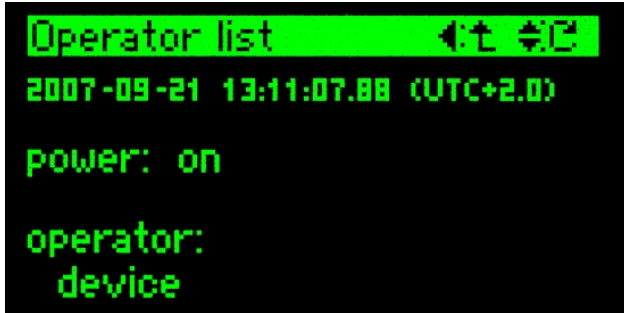

### list entry

The time stamp shows the time of the occurrence of the event. The predefined text describes the event. If applicable a *detail code* is also given (see below). If possible the user is shown who has provoked the event. By means of the keys ▲ and ▼ it's possible to browse the existing entries.

## Monitored events

### • Auxiliary power supply

- ON or return
- OFF or fail

### • Configuration

- Modification of clock parameters
- Modification of interface parameters
- Configuration change with *detail code (binary)*

(Dist. recorder)	Display	Mean values	Meters	Logger + lists	I/O-Modules	Measurement	Logic module	Limit module
0/1	0/1	0/1	0/1	0/1	0/1	0/1	0/1	0/1

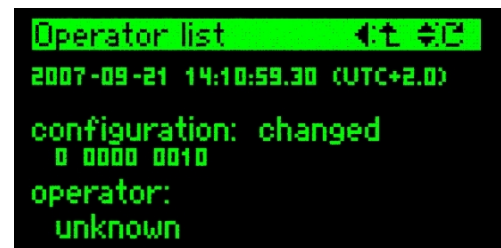

e.g. logic module data changed

### • Security system

- Activation
- Deactivation
- Right of user 1, 2 or 3 changed
- Log-in of a new user

### • Logger

- mean values t1 or t2: start
- mean values t1 or t2: stop
- mean values t1 or t2: reset
- min./max.: start
- min./max.: stop
- min./max.: reset

### • Simulation

- Logic module: on / off
- Analog outputs: on / off
- Digital outputs: on / off



**Alarm handling**

- Acknowledgement of all active alarms
- Selective alarm acknowledgement LS1..16, with *detail code (binary)*

LS16	LS15	LS14	LS13	LS12	LS11	LS10	LS9	LS8	LS7	LS6	LS5	LS4	LS3	LS2	LS1
0/1	0/1	0/1	0/1	0/1	0/1	0/1	0/1	0/1	0/1	0/1	0/1	0/1	0/1	0/1	0/1

- Selective alarm acknowledgement LS17..32, with *detail code (binary)*

LS32	LS31	LS30	LS29	LS28	LS27	LS26	LS25	LS24	LS23	LS22	LS21	LS20	LS19	LS18	LS17
0/1	0/1	0/1	0/1	0/1	0/1	0/1	0/1	0/1	0/1	0/1	0/1	0/1	0/1	0/1	0/1

**Reset**

- Standard meters
- Meters of the module inputs
- min./max. of instantaneous values with *detail code (binary)*

PF min	S max	Q max	P max	Freq. min.	Freq. max.	IB max	I max	U min	U max
0/1	0/1	0/1	0/1	0/1	0/1	0/1	0/1	0/1	0/1

- min./max. harmonic analysis with *detail code (binary)*

TDD.I	THD.U	THD.U31	THD.U23	THD.U12	TDD.I3	TDD.I2	TDD.I1	THD.U3	THD.U2	THD.U1	Unbal. U
0/1	0/1	0/1	0/1	0/1	0/1	0/1	0/1	0/1	0/1	0/1	0/1

- min./max. mean values t1 with *detail code (binary)*, up to 12 mean values

t1.12	t1.11	t1.10	t1.9	t1.8	t1.7	t1.6	t1.5	t1.4	t1.3	t1.2	t1.1
0/1	0/1	0/1	0/1	0/1	0/1	0/1	0/1	0/1	0/1	0/1	0/1

- min./max. mean values t2 with *detail code (binary)*, up to 12 mean values

t2.12	t2.11	t2.10	t2.9	t2.8	t2.7	t2.6	t2.5	t2.4	t2.3	t2.2	t2.1
0/1	0/1	0/1	0/1	0/1	0/1	0/1	0/1	0/1	0/1	0/1	0/1

For the evaluation by means of the software CB-Analyzer no *detail code* is required, because they are converted into plaintext messages. Thereby single events, e.g. the modification of all parts of the configuration of the device, are converted

into multiple events with the same time. Because the display contrary to the PC software hasn't the possibility to show more than one entry at a time this conversion would have been confusing.

## B7 Logger

The **Logger** serves for long-term recordings of measurement progressions. The user can record variations of instantaneous values (min/max values) or mean values. It's also possible to make automatic meter readings.

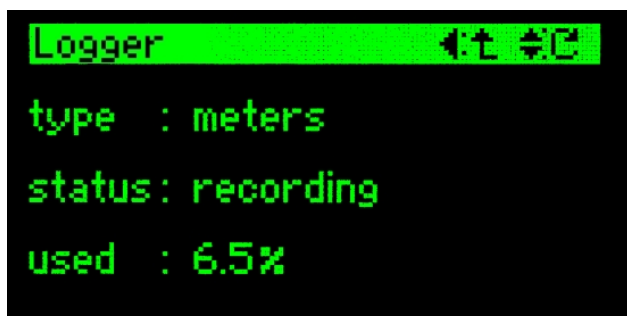
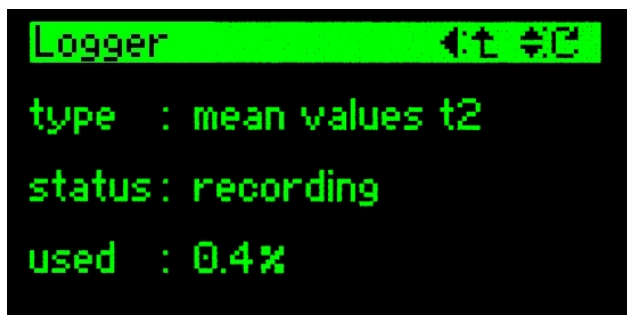
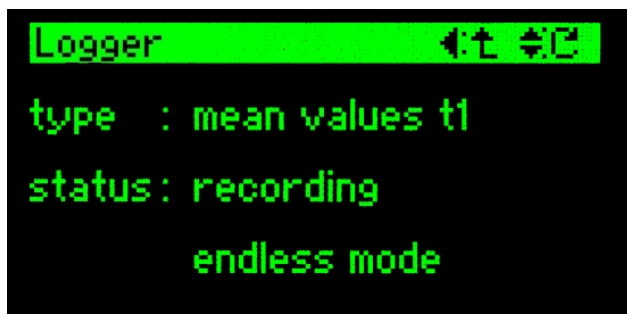
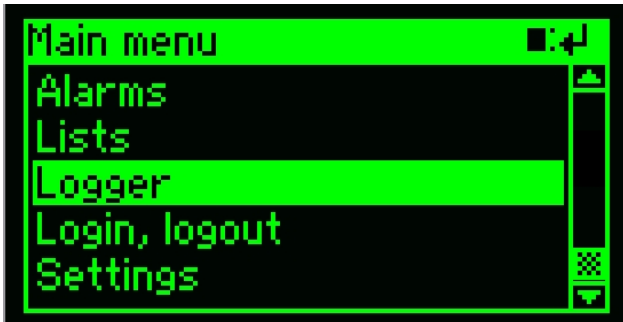

Via display the status of the logger can be requested. This way it's possible to make an assumption how long the corresponding data recording can continue. If the endless recording mode is used no specific state information is available.

### logger status

Via the menu item logger in the main menu the state display of the active data loggers can be entered. If no logger is active or the option is not implemented, then after the selection of the menu item logger no further action is performed.

### mean values logger (endless mode)

In this example the recording of mean values with interval time t1 is active. The logger records data using the endless mode. Therefore no information about the usage of the dedicated memory is available. To go to the state information of other logger types use ▲ and ▼.

### mean values logger (one-time)

The recording of mean values with interval time t2 is active. The logger is currently recording. Because the memory usage is given with 0.4% you know that the logger uses the one-time recording mode. As soon as the usage reaches 100% recording will stop.

### meters logger

In this example the automatically reading of meter contents is active. The recording is performed one time and stops as soon as the dedicated memory part is used.

## B8 Menu overview

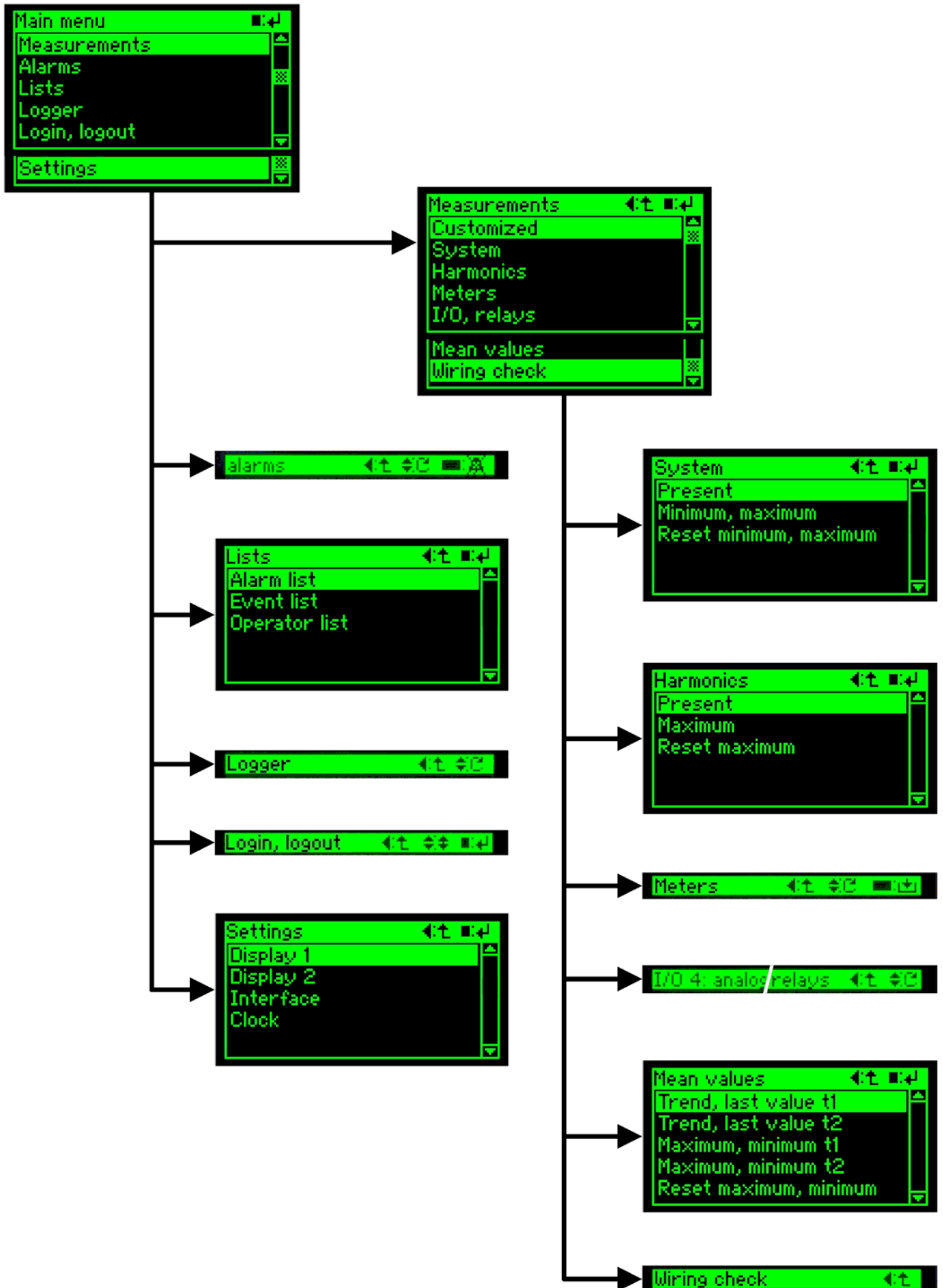

## C Operating instructions Rogowski coils

# Flexible AC Current Probes

**ACP 3000\_5**

**ACP 3003\_5**



### C1 Safety

The following symbols appear on the products:



Attention! Refer to Manual



Double/Reinforced Insulation



Do not apply around or remove from HAZARDOUS LIVE conductors without additional protective means.

“Additional protective means” can be de-energizing the circuit or wearing protective clothing suitable for high voltage work.



Do not dispose of this product as unsorted municipal waste. Contact a qualified recycler for disposal.



Complies with the relevant European standards



**Read all instructions completely before using this product..**

**To avoid electric shock:**

- Use caution during installation and use of this product; high voltages and currents may be present in circuit under test.
- This product must be used only by qualified personnel practising applicable safety precautions.
- Wear protective clothing and gloves as required.
- Do not install this product on live conductors.
- Always de-energise circuit under test before installing flexible measuring head. Always inspect the electronics unit, connecting cable, and flexible probe for damage before using this product.
- Do not use product if damaged.
- Always connect electronics unit to display device before installing the flexible measuring head.
- Always wear protective clothing and gloves if hazardous live parts are present in the installation where the measurement is carried out.
- If the probe is used in a manner not specified by the manufacturer the protection provided by the equipment may be impaired.

**C2 Introduction**

The ACP 3000\_5 and ACP 3003\_5 are AC current probes utilising Rogowski principle. They can be used to measure AC current up to 3000A, when used with oscilloscopes, recorders or data loggers. The flexible probe allows current measurements on conductors that are hard to reach.

The probes provide a 3V full scale AC output proportional to the current being measured with three selectable ranges.

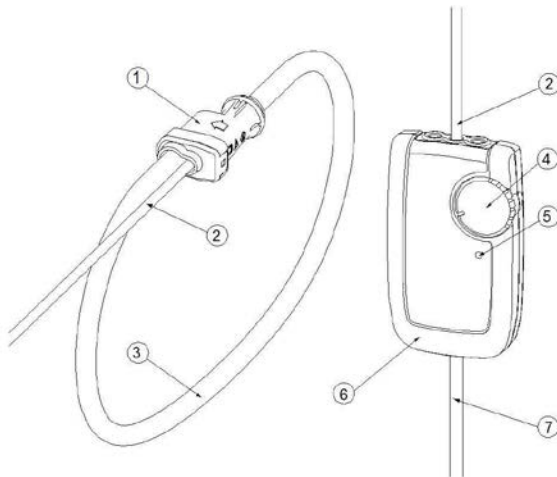

Fig. 1

1. Probe Coupling
2. Probe Output Cable
3. Flexible Current Probe
4. Power On / Range Switch
5. RED LED – Overload
6. Integrator Housing
7. Output Cable

### C3 Specifications

Measuring ranges	30A / 300A / 3000A AC
Output sensitivity	100mV / 10mV / 1mV per A (AC coupled)
Accuracy (45-65Hz)	± 1% of reading ± 0.1A 30/300A ± 1% of reading ± 1A 3000A
Minimum load	100k for specified accuracy
Frequency range	10Hz to 20kHz (-1dB)
Phase	<± 1° (45-65 Hz)
Position sensitivity	± 2% of reading
External field	± 0.2% of range with cable >200mm (8") from the probe
Noise	8mV eff. in 30A range 2mV eff. in 300A / 3000A ranges
Temperature coefficient	± 0.1% of reading /°C
Power supply	Provided by CAM mobile
Overload	Indicated by a red LED

#### Enclosure

Material	ARNITE T06-200SNF, UL94 V0
Degree of Protection	IP40
Dimensions	110 (l) x 65 (w) x 23 (d) mm

#### Probe

Probe length	610mm (24"), double insulated
Probe diameter	9.9 mm (0,39")
Output cable	2m (78.7"), probe to integrator
Material	Alcryn 2070NC, LATI LATENE 7H2W V0
Degree of Protection	IP65

#### General Characteristics

Operating temp.	-20°C up to +80°C
Storage temp.	-40°C up to 90°C
Operating humidity	15% up to 85% (non-condensing)
Safety standards	EN 61010-1:2001 EN 61010-031:2002 EN 61010-2-032:2002
EMC	EN 61326-2-2 :2006

1000 V<sub>RMS</sub>, Category III, 600 V<sub>RMS</sub>, Category IV, Pollution Degree 2 (Probe and integrator)

30V maximum between output and earth (ACP 3005)

ROHS and WEEE compliant

Rated for continuous use

## C4 Operation

### C4.1 Measuring current



**Read safety section of instructions before operating this product.**



**Ensure conductor to be tested is de-energised**

Connect the output of the electronics to the input of an oscilloscope or other data recording device.



**The flexible current probe is not for use on conductors with a potential of over 1000V.**

Wrap the flexible probe around the conductor to be tested, close coupling. Energise the circuit under test. Locate the coupling away from nearby conductors.



**Always use appropriate equipment for personal protection. Do not use the flexible current probe to measure bare conductors unless wearing protective clothing suitable for high voltage work.**

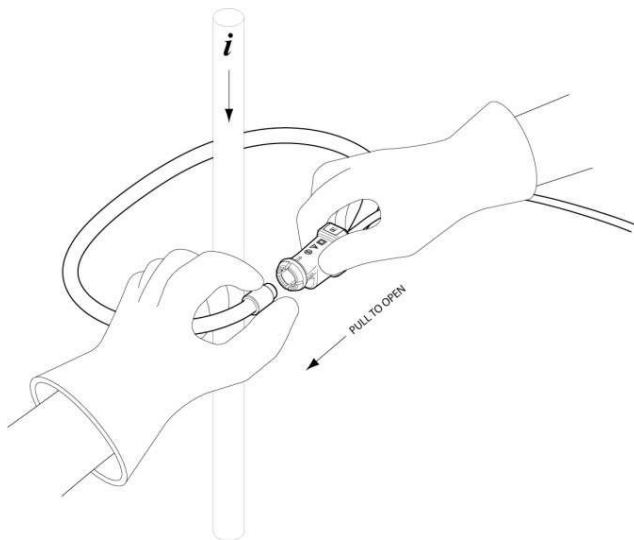

### C4.2 Operation

To activate unit, move the rotary switch from the "off" position to the required measuring range. If the value of current being measured is unknown, first select the highest range and then reduce accordingly.

## C5 Maintenance



**Do not use ACP 3000\_5 or ACP 3003\_5 if damaged.**

Always inspect the integrator unit, connecting cable, and flexible probe for damage before use.

To avoid electric shock, keep the ACP clean and free of surface contamination.

Use Isopropyl alcohol to clean the electronics unit and the probe

Make sure the flexible probe, connecting cable, and electronics enclosure are dry before further use

## D Installation of PC software

### D1 Installation of CB-Manager software

#### D1.1 For Windows 2000 / Windows XP

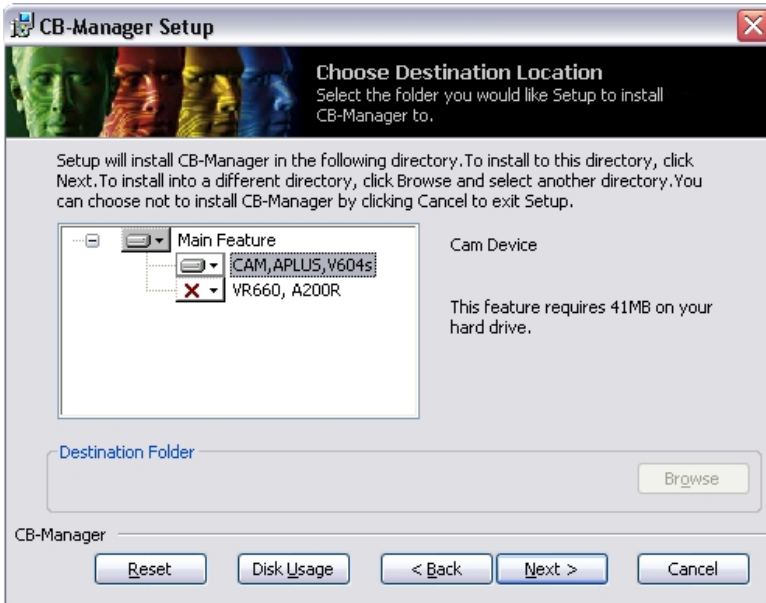

In the directory CB-Manager on the CD start the program "**setup.exe**", which **installs both** CB-Manager software and USB support.

If the software is already installed an appropriate message is displayed. In this case follow the instructions given.

The software can be used for multiple devices. Select the required group of devices to support and click 'Next'.

The base software will be installed...

After the installation of the base software the following window is displayed. Click on 'OK' to start the installation of the USB support.

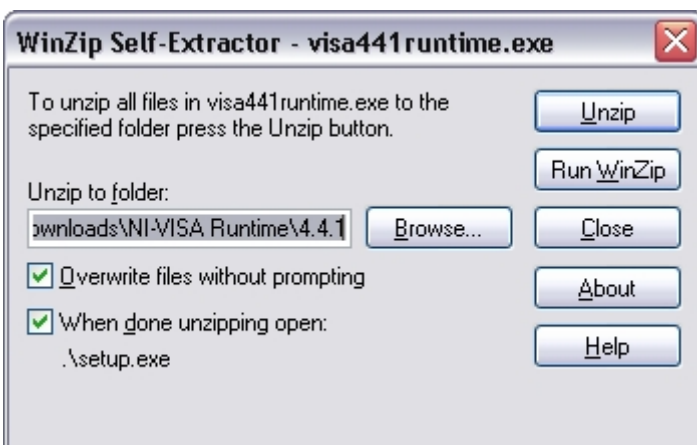
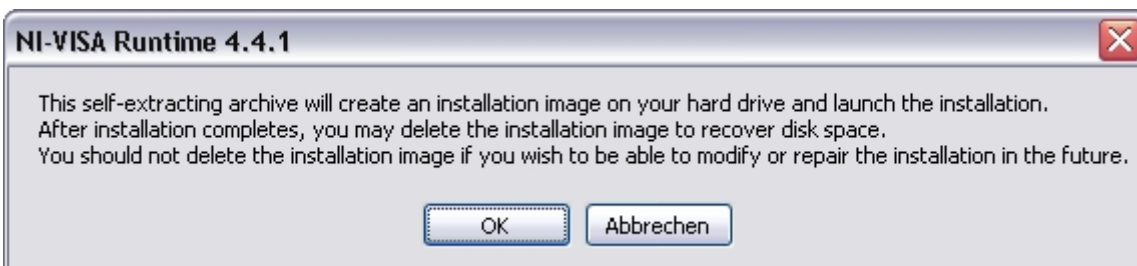

The program for the driver software installation first has to be 'extracted', because it's stored in condensed form on the CD.

If the software WinZip is installed on your PC select "Run WinZip" and then start the program 'setup.exe'.

If WinZip isn't installed select "Unzip". The installation software is started at the end of the decompressing process.



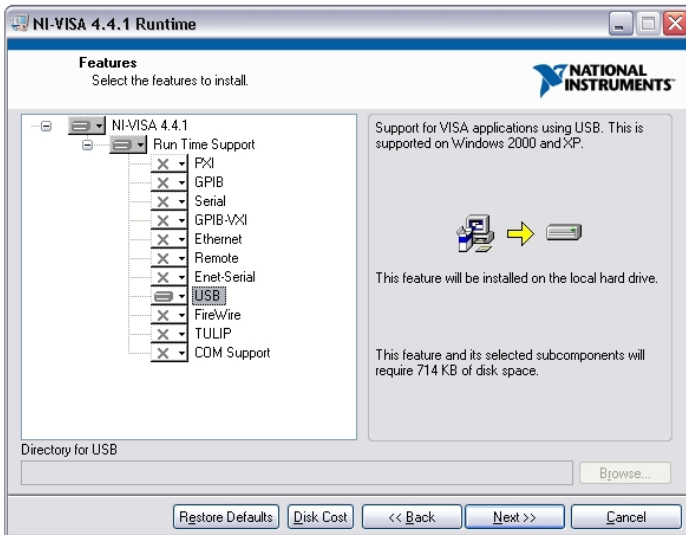

For the CB-Manager software USB support is required only. All other drivers may be deselected.

Click on 'Next' to install the support.

At the end of the installation process you may be prompted to reboot your computer.

### D1.2 For Windows Vista / Windows 7

Windows Vista / Windows 7 may not accept "setup.exe" as valid installation software. Therefore the installation procedure described in 1.1 must be performed manually in the following 2 steps:

1. Installation of the basic software using the application "**CB-Manager.msi**"
2. USB driver installation via the program "**visa441runtime.exe**"

### D1.3 USB support

The USB support is limited to the operating systems Windows 2000, XP, Vista and 7.

Each USB device will be registered in the Windows operating system when it is connected to the computer for the first time. Because each USB device has a unique identification a repeating registering is required also for similar devices. Therefore the USB driver has to be registered once for each individual device.



#### Windows 2000 / XP

When a SINEAX CAM is connected to the PC using the supplied USB cable the opposite window appears.

**DO NOT CANCEL! Wait until the wizard for found new hardware is started. This may take a few seconds. If you cancel the installation at this point the USB driver is not installed correctly. The communication with the device will not work. Remove the USB cable and plug it again, then install the USB driver completely.**

Select "No, not this time" and then "Next". The driver for this device will be installed.

#### Windows Vista / Windows 7

The installation of the USB driver is done automatically in the background. No user input is required.



#### Error when linking the driver using the wizard

If the hardware wizard is not able to find the necessary driver, it probably hasn't been installed correctly. Repeat the installation of the USB driver by executing the program "**visa441runtime.exe**" on the CD.

#### D1.4 First run of the CB-Manager software

On **first** startup of the software (and only at this time) the following window appears:

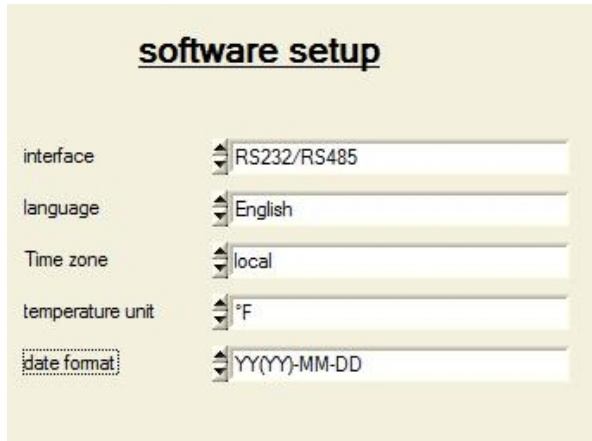

Here you may define default values for communication interface, dialog language, time zone, temperature unit (for V604s, A200R, VR660) and the date format to be used.

If the interface RS232/RS485 is selected you can subsequently define interface parameters. By limiting the possible address range the search for connected devices can be accelerated.

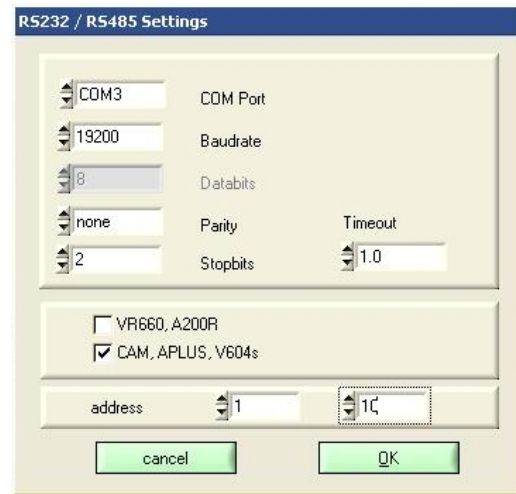

**The usage of the CB-Manager software is comprehensively described under Help | Contents. There you may find more detailed information as well, which can also be requested context specific.**

#### D1.5 Remedy for USB communication problems

Check if device has been recognized correctly



Each CAM which is connected to the computer will be registered in the "device manager". There the CAM is listed as "USB Test and Measurement device" as long as the USB connection exists and the device is switched on. If the driver hasn't been installed correctly a yellow **warning triangle** is shown next to the appropriate device. See [D1.3](#) and [D1.6](#)

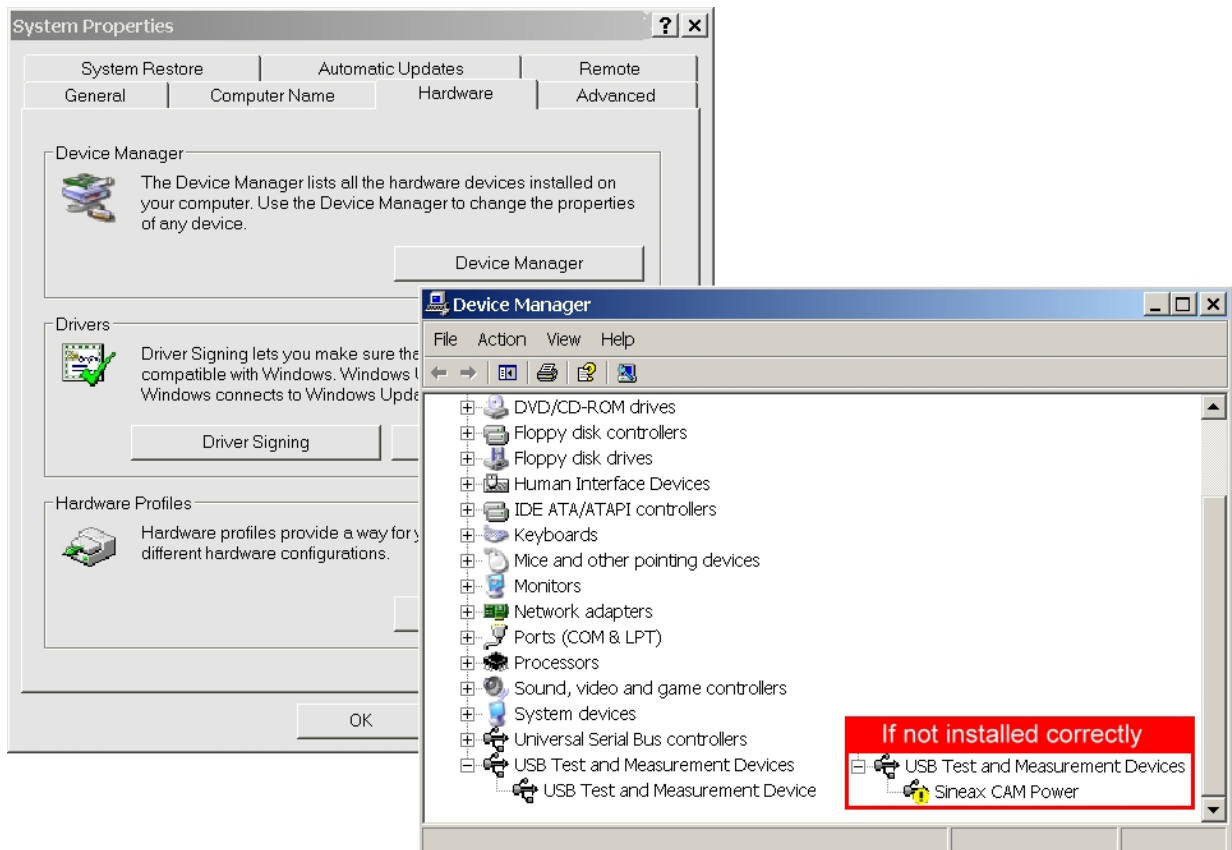

## Windows Vista / Windows 7

### Driver is correctly installed, but communication not possible



If the driver is installed correctly but the CB-Manager Software is not able to communicate via the USB interface, a problem with user rights may exist. Maybe the file storage of the communication settings on the hard disk is locked as well. In this case the sub-folder **Settings** is not created after the first run of the software.

Communication via USB interface as well as file storage via software is handled quite restrictive under Windows Vista due to possible security problems. There are two methods to solve the problem:

- **Turn off the user account control**, see [Annex D3](#)
- **Run the program as administrator** (right mouse click on the symbol)

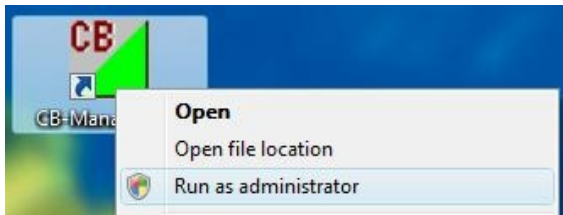

## D1.6 Removing USB devices from the control panel

Each CAM device once connected to the PC is registered in the operating system. There are various reasons for removing such entries:

- The corresponding device has been configured and built-in in the plant.
- USB communication with the device doesn't work. You wish to reinstall the driver.
- The number of entries is large and confusing

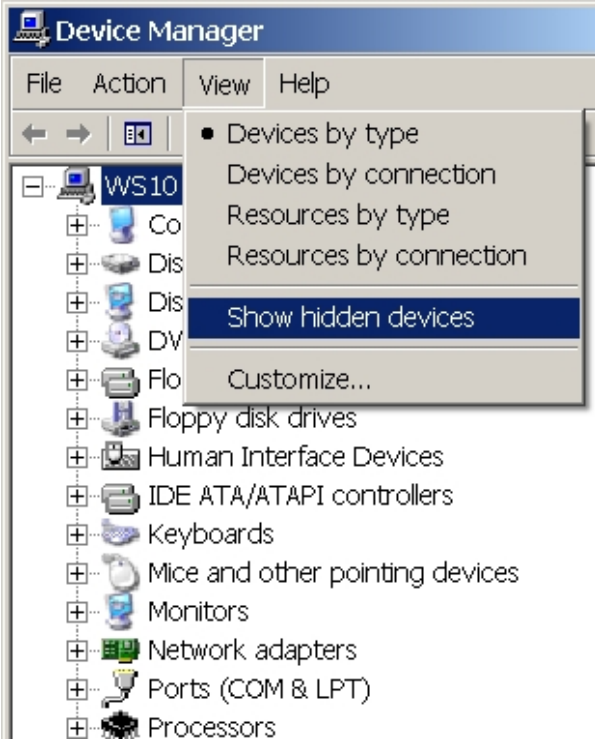

Normally the device manager shows only devices actually connected to the PC. To see all registered devices you have to check the option 'Show hidden devices' in the device manager.

Then all registered CAMs will be shown as *USB Test and Measurement Device*.

CAM devices currently not connected to the PC system will be shown with a gray USB symbol. Otherwise the device is switched on and the connection is established.

An **identification of single devices** is a little bit tricky. Via Properties | Details the USB identification of a registered CAM can be displayed. In the example '0C870001'.

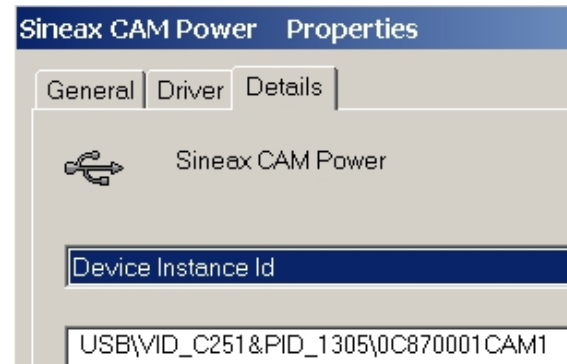
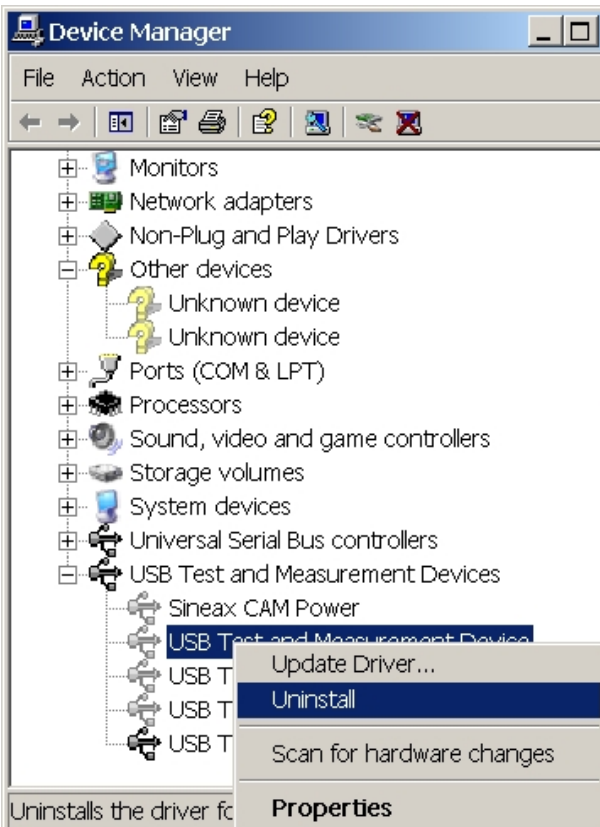

Using the CB-Manager software you can read the CAM configuration. Its identification number is shown in the HTML file which is created when printing the configuration of the device.

To **remove a CAM from the device manager** click on the right mouse key and select Uninstall.

To settle problems with devices and a non-working USB communication try one of the following two ways:

- Update the driver
- Uninstall the device and bind the driver again when the device is connected again

## D2 Installation of CB-Analyzer software

The installation of the software comprises two parts. Along with the application software CB-Analyzer the run time environment of Microsoft .NET must be installed in form of the .NET framework.

### D2.1 Installation of the base software

In the directory CB-Analyzer on the CD execute the file **setup.exe**

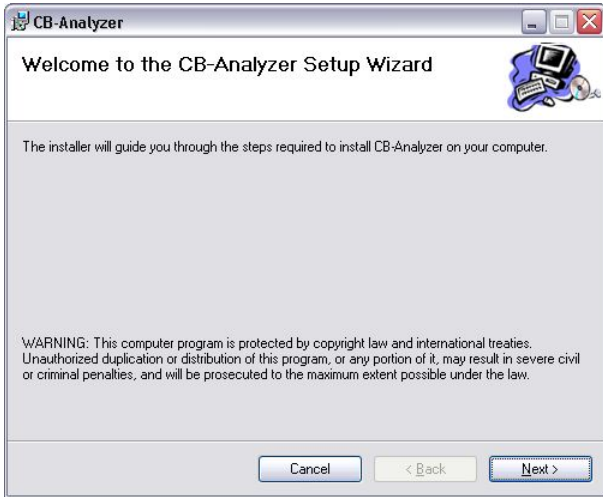

If the software is already installed an appropriate message is displayed. In this case follow the instructions given.

If the welcome window is shown click on "Next".

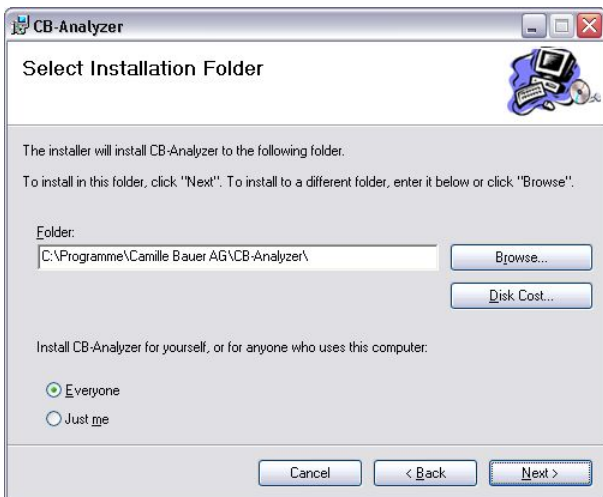

If you don't want to install the software in the standard directory select another folder using "Browse". "Disk cost" allows checking on which drives there is enough storage space available for the installation.

CB-Analyzer can be installed for all user of a computer ("Everyone") or for the present user ("Just me") only. Select your preferred option and click on "Next".

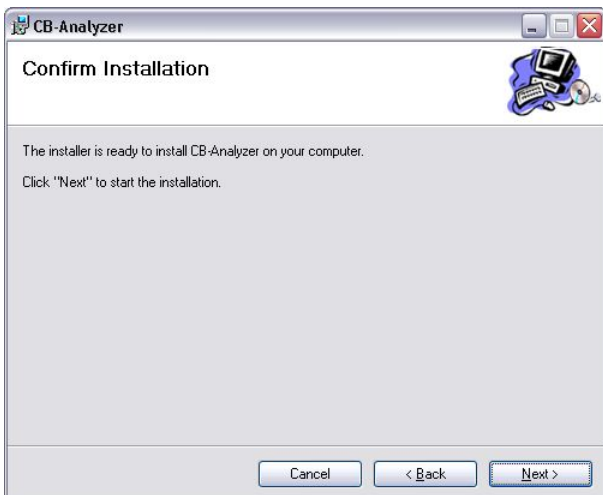

Confirm that you want to start the installation now using "Next" or go back to check or modify your selections using "Back".

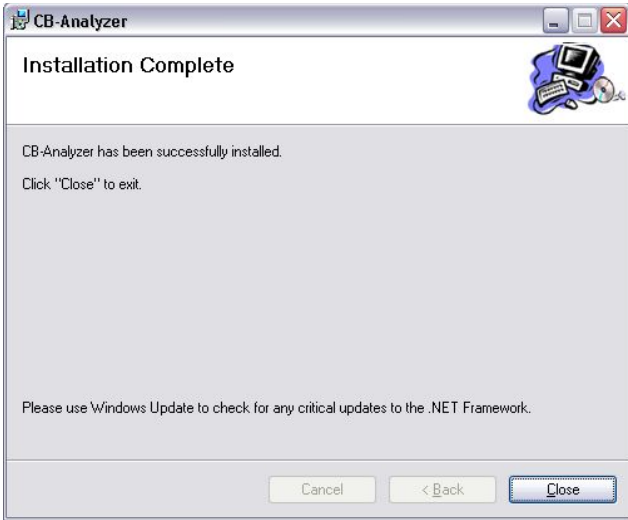

The installation takes normally a few minutes. The successful completion will be confirmed.

Select "Close" to complete the installation.

## D2.2 Installation of Microsoft .NET framework 4

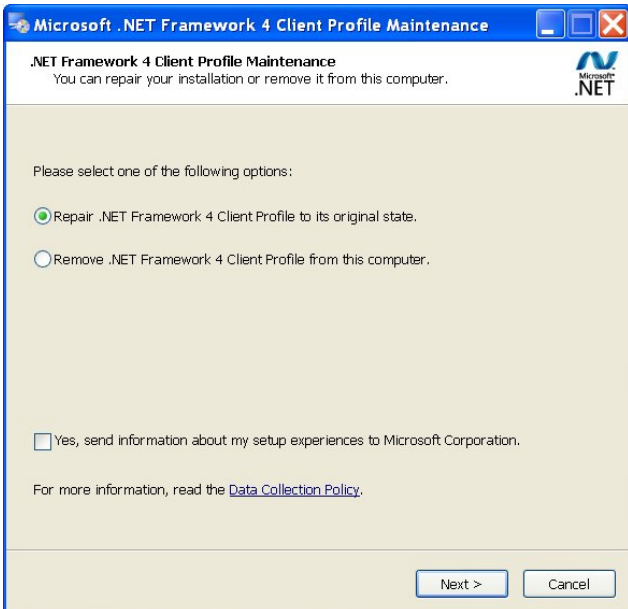

### Windows Vista / 7

The .NET framework is part of the operating system. An installation is required only if there is an older .NET version installed.

### Windows 2000 / XP

Proceed to the sub-folder *Microsoft .NET Framework 4* and execute the file "**dotNetFx40\_Client\_x86\_x64.exe**".

If .NET framework is already installed on your computer the maintenance window is displayed. If at least .NET version 4 is installed you can cancel the installation process using "Cancel".

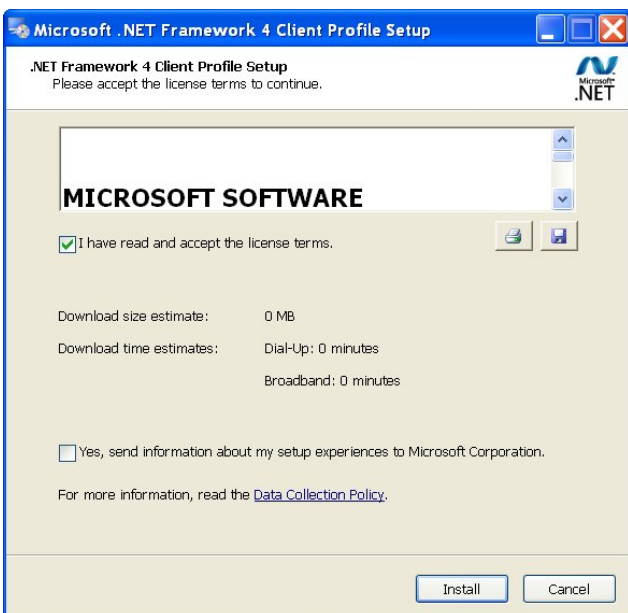

Read the license agreement of Microsoft and confirm that you agree to the terms.

Click on "Install". The installation of .NET framework starts...

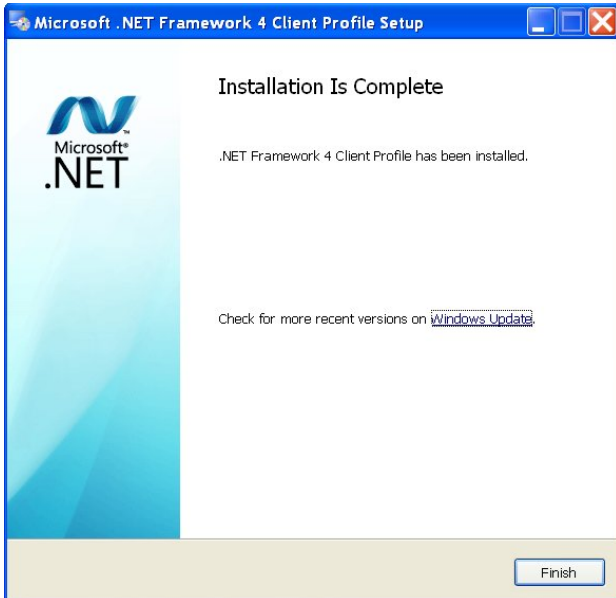

The installation takes normally a few minutes. The successful completion will be confirmed.

Select "Finish" for completing the installation.

### D2.3 First run of the CB-Analyzer software

Following the first start-up of the software the communication interface and the data base must be set, before data can be requested from connected devices.

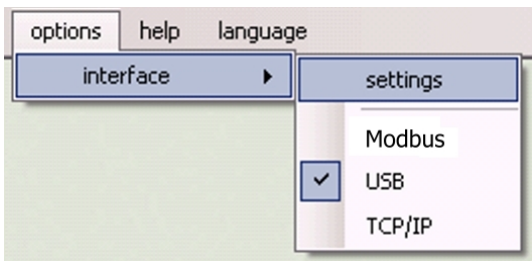

Select the **communication interface** to which the devices are connected. The Modbus or TCP/IP interfaces may require an additional modification of the settings.

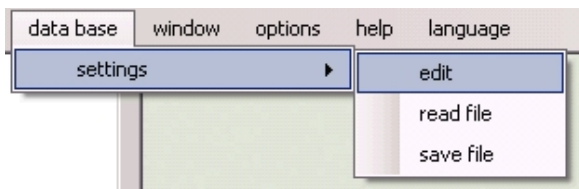

In the data base menu select settings | edit.

The settings window for the data base will be displayed...

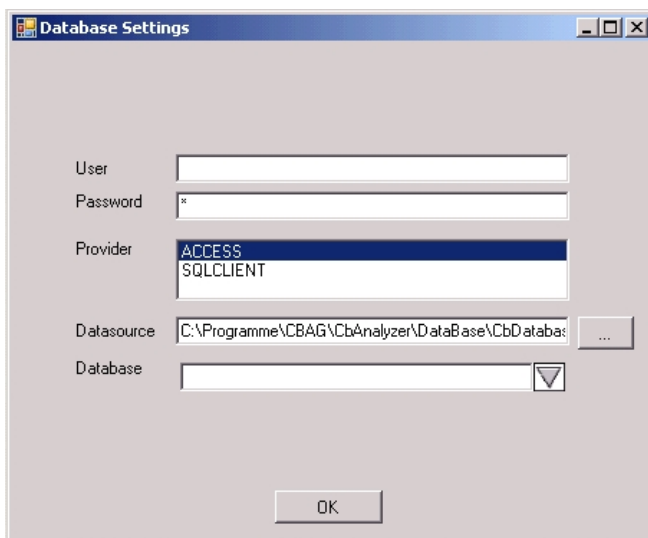

Select e.g. to use an ACCESS data base. Then you have to select the data source with its complete path. To do so, select the data base file in the sub-directory *DataBase* of the installation directory of the CB-Analyzer software.

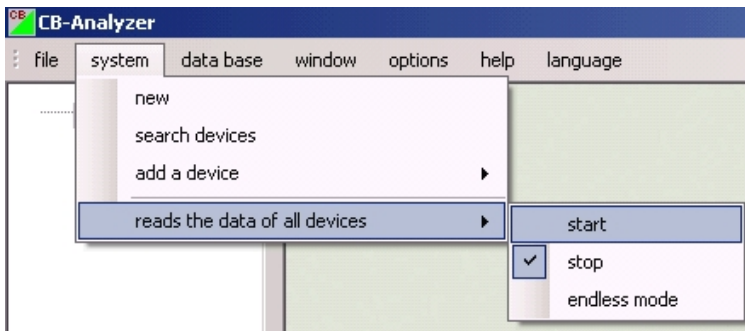

Now you are able to search for connected devices via the menu system.

Then you can start the acquisition of data by clicking on "start". The menu item "endless mode" has the same functionality, but in addition checks from time to time if new data is available in the devices.







Further information on how to use the software, especially how to create analysis reports, may be found in the help files of the CB-Analyzer software.

#### D2.4 Remedy for communication problems

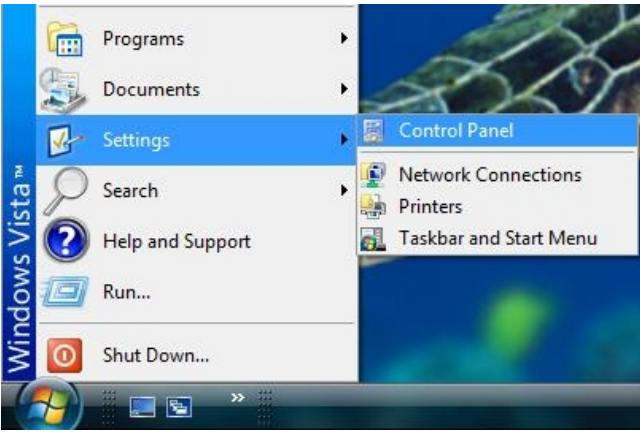
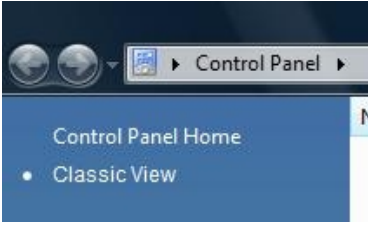
Possible problems with USB communication are described in [chapter D1.5](#). Notice that the CB-Analyzer software may not (as the CB-Manager software) be executed directly with administrator rights.



### D3 Turn off User Account Control of Windows Vista / 7

1.	 A screenshot of the Windows Vista Start menu. The 'Control Panel' option is highlighted in blue. Other visible options include Programs, Documents, Settings, Search, Help and Support, Run..., and Shut Down... The taskbar at the bottom shows the Start button and several application icons.
2.	 A screenshot of the Control Panel Home window. The 'Classic View' option is selected with a radio button. The window title bar shows 'Control Panel'.
3.	 The 'User Accounts' icon from the Windows Vista Control Panel, featuring a blue background with a white border and an illustration of two people.
4.	<p>Make changes to your user account</p> <p>Change your picture</p> <p> <a href="#">Turn User Account Control on or off</a></p> <p> <a href="#">Manage User Accounts</a></p> <p>To change your password, press Ctrl+Alt+Del and select Change a Password</p> 
5.	<p>Turn on User Account Control (UAC) to make your computer more secure</p> <p>User Account Control (UAC) can help prevent unauthorized changes to your computer. We recommend that you leave UAC turned on to help protect your computer.</p> <p><input type="checkbox"/> Use User Account Control (UAC) to help protect your computer</p> <p>OK Cancel</p>
6.	 A Microsoft Windows dialog box with a white background and a blue title bar. The text reads: 'You must restart your computer to apply these changes. Before restarting, save any open files and close all programs.' There are two buttons at the bottom: 'Restart Now' and 'Restart Later'.

## E Declaration of conformity



**EG - KONFORMITÄTSERKLÄRUNG  
EC DECLARATION OF CONFORMITY**



Dokument-Nr./ Document.No.: CAM\_mobile\_CE-konf.DOC

Hersteller/ Manufacturer: **Camille Bauer AG**  
Switzerland

Anschrift / Address: **Aargauerstrasse 7**  
**CH-5610 Wohlen**

Produktbezeichnung/ Product name: **Portabler Netzanalysator**  
**Portable power analyzer**

Typ / Type: **CAM mobile**

Das bezeichnete Produkt stimmt mit den Vorschriften folgender Europäischer Richtlinien überein, nachgewiesen durch die Einhaltung folgender Normen:

The above mentioned product has been manufactured according to the regulations of the following European directives proven through compliance with the following standards:

Nr. / No.	Richtlinie / Directive
2004/108/EG	Elektromagnetische Verträglichkeit - EMV-Richtlinie
2004/108/EC	Electromagnetic compatibility - EMC directive

EMV / EMC	Fachgrundnorm / Generic Standard	Messverfahren / Measurement methods
Störaussendung / Emission	EN 61000-6-4 : 2007	EN 55011
Störfestigkeit / Immunity	EN 61000-6-2 : 2005	IEC 61000-4-2 IEC 61000-4-3 IEC 61000-4-4 IEC 61000-4-5 IEC 61000-4-6 IEC 61000-4-8 IEC 61000-4-11

Nr. / No.	Richtlinie / Directive
2006/95/EG	Elektrische Betriebsmittel zur Verwendung innerhalb bestimmter Spannungsgrenzen – Niederspannungsrichtlinie – CE-Kennzeichnung : 95
2006/95/EC	Electrical equipment for use within certain voltage limits – Low Voltage Directive – Attachment of CE marking : 95

EN/Norm/Standard	IEC/Norm/Standard
EN 61010-1: 2001	IEC 61010-1: 2001

Ort, Datum / Place, date:

Wohlen, 17. August 2011

Unterschrift / signature:

**M. Ulrich**  
Leiter Technik / Head of engineering

**J. Brem**  
Qualitätsmanager / Quality manager