

## flow-captor 412x.1xM/.40M/.41M

### Operating Instructions

Please read carefully! No liability can be accepted for damage caused by improper use of the captor!



#### 9. Protection cap

To protect the flow-captor from environmental influences and unintended adjustment the flow-captor will be delivered with a screw cap. After adjustment of the flow-captor screw on the cap tightly. So the O-ring will seal the flow-captor to get protection standard IP67.

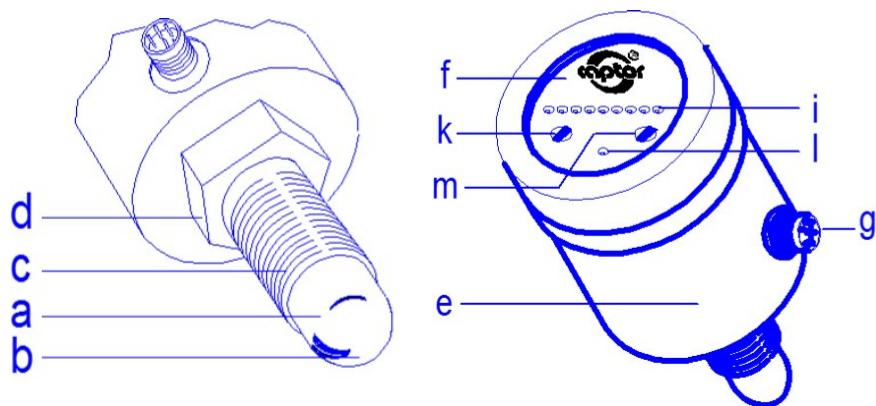

- a Sensor head of stainless steel WN 1.4305 (V2A, 303) (standard quality)
- b Sensing surface
- c Thread, G 1/2 A (1/2" BSP), alt. 1/2" - 14 NPT
- d Section for SW 27 spanner (wrench)
- e Housing, WN 1.4305 (V2A, 303)
- f Housing, front plate, anodized aluminium
- g Plug M 12x1, 4-pin
- i Display of 9 LED, functions:
  - 1.) Analog display of flow from 0 to 100%
  - 2.) Display of set-point by flashing LED, adjustable from 1. to 8. LED
- k Potentiometer for „Set-point“
- l LED for output indication „Flow-OK“
- m Potentiometer for „Range“

**weber**

## flow-captor Typ 412x.1xM/.40M/.41M

### Operating Instructions

Please read carefully! No liability can be accepted for damage caused by improper use of the captor!



#### 1. Mounting Position

To obtain highest accuracy of switching signal, the flow-captor should be mounted in a position of minimum turbulence. The position should be at least 5 x ID downstream and 3 x ID up-stream of bends, valves, T-pieces or changes in pipe diameter. Immersion depth min. 5 mm for small pipes up to 1 1/2" ID.

Preferred position is in a vertical pipe with upward flow.

In a horizontal pipe, the flow-captor should be mounted at the side.

The sensor head orientation is independent from the flow direction.

#### 2. Mechanical Installation

The flow-captor should be installed into pipe at sufficient depth to ensure that the sensing surface is in contact with the flowing medium at all times. This is particularly important, if the flow-captor is mounted on top of the pipe or in a T-piece larger than the pipe work where cavitation (air bubbles) may occur.

The flow-captor can be installed in a T-piece. However it is much better to install the unit in a fitting welded to the pipework.

The thread should be sealed with Teflon tape or other commercial sealer, then the flow-captor tightened in the fitting using a size SW 27 spanner (wrench).

The final position should have the LED chain horizontal and reading left to right.

**Caution: On no account the flow-captor housing should be used for tightening into the pipework.**

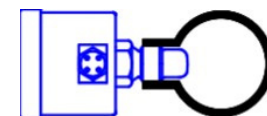
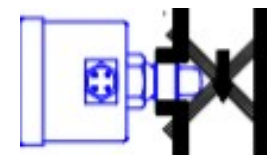
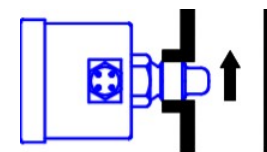

**weber**

# flow-captor 412x.1xM/.40M/.41M



## Operating Instructions

Please read carefully! No liability can be accepted for damage caused by improper use of the captor!

### 3. Electrical Connection

Insert plug gently into unit socket (do not force as plug can only be mounted in correct way). Then tighten the plug connection by hand (that only ensures a sealing according to protection class IP67). Connect wire end of the cable to power supply according to connection diagram, (brown to + voltage, blue to - voltage). The voltage must be kept within the specified range at all times (18 to 30 VDC incl. residual ripple). Single rectification, i. e. half wave voltage, is not allowed.

Load i. e. a relay between black (output) and blue (-). After connecting the supply voltage the 1<sup>st</sup> LED shines and one of the other 8 LEDs is flashing (adjusted set-point). After approx. 8 seconds the sensor is ready for operation (at zero flow only the 1<sup>st</sup> LED lights up).

### 4. Medium

Scale of range potentiometer on 412x.1xM is related to water. Depending on viscosity and thermal conductivity, other media require a multiplier (> 1) i. e. 3 to 5 x for oil.

4121.1xM is calibrated specifically for use with oil. The scale is equally divided between zero flow and max. flow range. Absolute values are shown as these will vary with different types of oil.

### 5. Measurement of Flow Velocity (only 4120.1xM)

Turn range potentiometer clockwise to maximum (3 m/s).

According to the flow rate a number of LED's will be lit. In order to read the correct flow rate, turn the range potentiometer slowly, stepwise, counter-clockwise – this allows for a re-adjustment of the range – until all LEDs are lit.

The actual flow speed is indicated by a white arrow on the range pot.

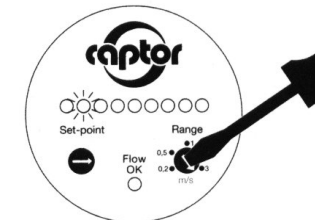
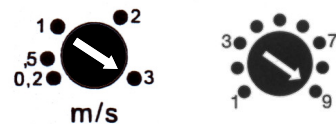
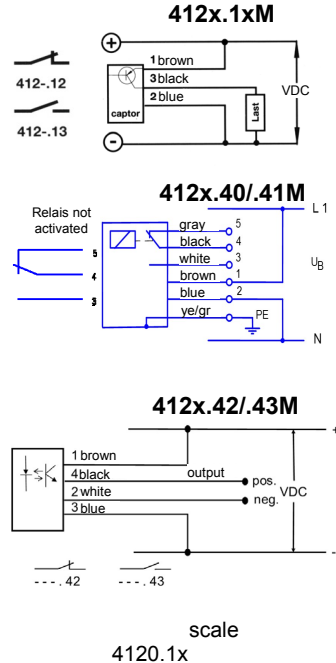

**weber**

# flow-captor Typ 412x.1xM/.40M/.41M



## Operating Instructions

Please read carefully! No liability can be accepted for damage caused by improper use of the captor!

### 6. Range Adjustment

With the range potentiometer it is possible to define any measuring range between 0-20 cm/s up to 0-300 cm/s for water (approx. 0-30 cm/s up to 0-300 cm/s for oil, 4121.1xM).

At the maximum flow rate, adjust the range potentiometer until all nine LEDs are just lit, each LED that is lit then represents approx. 10% of the maximum flow rate.

The resolution of the set-point depends on the range adjustment, e.g. with a range of 0-2 m/s the resolution is approx. 20 cm/s per LED step, with 0-30 cm/s the resolution is approx. 3 cm/s per LED step. When exceeding the adjusted measuring range by 10% the 9<sup>th</sup> LED is flashing with the double frequency of the set-point LED.

### 7. Set-Point Adjustment

The set-point can be adjusted to anywhere within 15% of the absolute minimum range and 90% of the absolute maximum range.

The set-point value is indicated by a flashing LED, and is shown relative to the adjusted range. When the velocity passes the flow set-point, the green "Flow OK" LED changes state (the green LED is lit if the velocity is above the set-point).

### 8. Response

The flow-captor offers the opportunity - in conjunction with the range and set-point selection - to adjust different response times. Since the signal is formed as an average flow fluctuations in the respective range will be largely suppressed.

- LED flashing
- LED on
- LED off

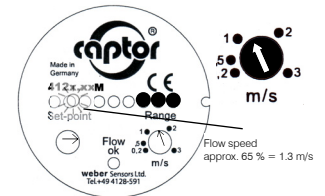

example

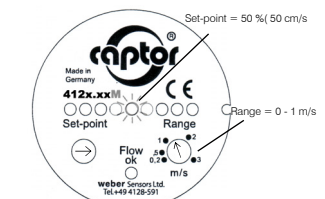

**weber**