

H-Series Circuit Breaker

The H-Series hydraulic/magnetic circuit breaker provides dependable circuit protection in a low cost, compact package. By meeting the IEC spacing requirements, the H-Series is the ideal choice for international market applications. It also features a "trip-free" mechanism, which will open the contacts when a fault condition occurs, even if the handle is held in the ON position. Although a low cost option, the H-Series was designed for maximum performance and reliable equipment protection meeting Carling's stringent quality standards.

Key Features & Benefits:

- Choice of actuator styles
- UL1077, CCC, CSA, C22.2 and EN60934 approvals
- Compact size
- Temperature stable operation -40°C to 80°C
- Choice of terminals, including PCB
- Single or multi-pole configurations



CURVED ROCKER ACTUATOR



HANDLE ACTUATOR



FLAT WITH PUSH-TO-RESET ACTUATOR



CURVED ROCKER WITH GUARD



Carling Technologies®

Innovative Designs. Powerful Solutions.

Innovative Designs. Powerful Solutions.

Product Bulletin #139
January 2012

Carling Technologies, Inc.

60 Johnson Avenue • Plainville, CT 06062-1177

Phone: (860) 793-9281 • Fax: (860) 793-9231

Email: sales@carlingtech.com • www.carlingtech.com

Electrical Tables

Table A: Lists UL Recognized, CSA Accepted and TUV Certified configurations and performance capabilities as a Component Supplementary Protector.

H SERIES - COMPONENT SUPPLEMENTARY PROTECTOR										
CIRCUIT CONFIGURATION	VOLTAGE			CURRENT		SHORT CIRCUIT CAPACITY (AMPS)			APPLICATION CODES	
	MAX RATING	FREQ.	PHASE	FULL LOAD	MINIMUM POLES	UL WITHOUT BACKUP FUSE	CSA WITHOUT BACKUP FUSE	TUV WITHOUT BACKUP FUSE	UL	CSA
	SERIES	65	DC	--	1 - 32	1	3000	3000	1500(PC1)	TC1, OL1, U1
65		DC	--	1 - 32	1	---	500	---	---	TC1, OL1, U3
80		DC	--	1 - 25	1	1000	800	1000(PC1)	TC1, OL1, U1	TC1, OL1, U1
80 ¹		DC	--	26 - 32	1	1000	1000	1000(PC1)	TC1, OL1, U3	TC1, OL1, U3
250		50/60	1	1 - 32	1	1500	1500	1000(PC1)	TC1, OL1, U1	TC1, OL1, U1
250		50/60	1	1 - 32	2	1500	1500	1000(PC1)	TC1, OL1, U3	TC1, OL1, U3
250		50/60	3	1 - 32	3	1500	1500	1000(PC1)	TC1, OL0, U3	TC1, OL0, U3

1 - Polarity Sensitive

Electrical

Maximum Voltage 250VAC 50/60Hz 80 VDC
 Current Rating Standard current coils: 1.00, 2.50, 5.00, 7.50, 10.0, 15.0, 20.0, 25.0, 30.0, 32.0
 Auxiliary Switch Rating SPDT: 10.1A-250VAC, 1.0A-65VDC/0.5A-80VDC, 0.1A-125VAC (with gold contacts)

Mechanical

Endurance 10,000 ON-OFF operations @ 6 per minute; with rated current & voltage

Physical

Number of Poles 1-3
 Weight Approx. 48 grams/pole (1.7 oz)
 Internal Circuit Config. Series and Switch Only (with or without auxiliary switch)

Agency Approvals

UL Recognized under the Component Recognition Program as Protectors, Supplementary (Guide QVNU2 File E75596)
 UL standard 1077

CCC certified, Certificate No. 2010010307447291

CSA Accepted Circuit Breaker, CSA standard C22.2 No. 235

TUV certified to EN60934, Certificate No. R50204086

Typical Protector Resistance

DCR and Impedance values are based on measurements by the voltmeter ammeter method. Rated current is applied for one hour and at a voltage not less than 20 volts. Ambient temperature: 25 °C; Tolerance: Below 10 amps +/- 25%; Above 10 amps +/-35%

Impedance Chart

Current rating in amperes	Series	
	DC-Ohms	50/60Hz-Ohms
1	0.85	0.87
2.5	0.13	0.15
5	0.035	0.036
7.5	0.018	0.019
10	0.01	0.011
15	0.006	0.0061
20	0.005	0.0051
25	0.003	0.0035
30	0.0025	0.0026

*Manufacturer reserves the right to change product specification without prior notice.

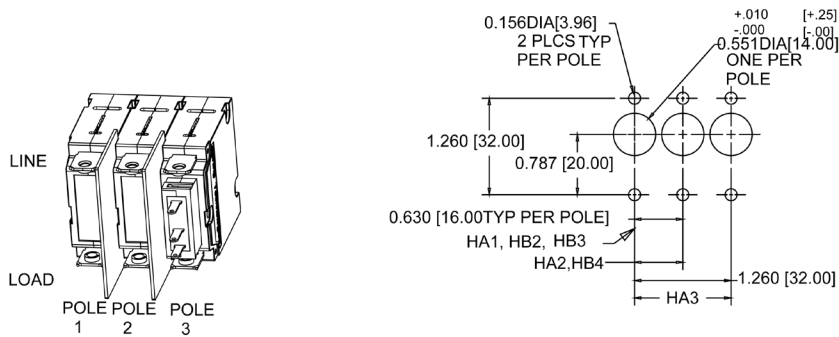
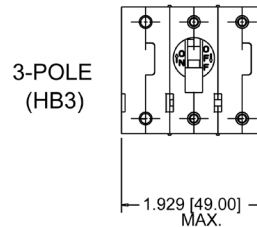
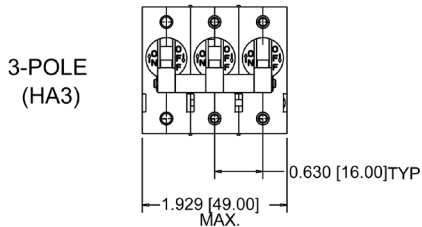
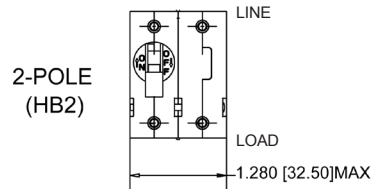
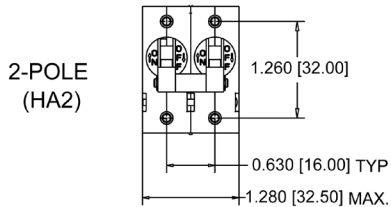
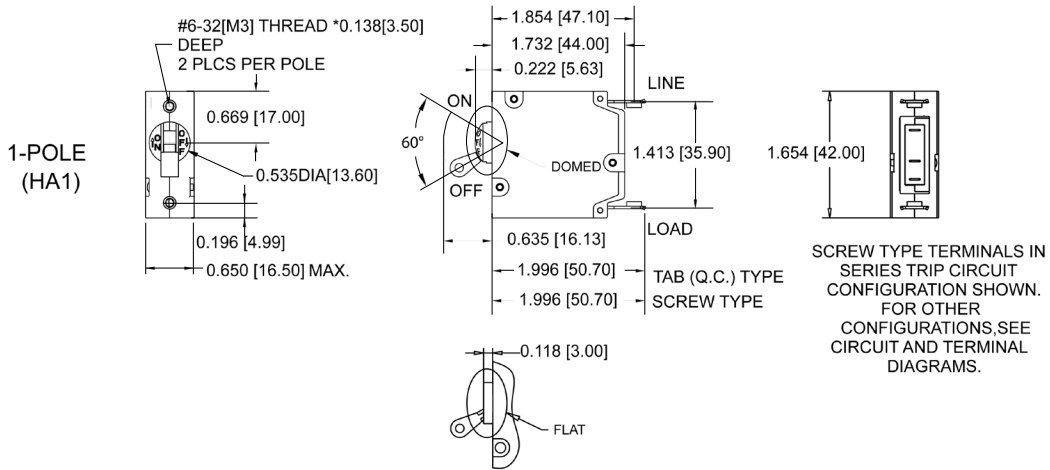

MULTI-POLE IDENTIFICATION SCHEME AS VIEWED FROM TERMINAL END OF BREAKER.

PANEL CUTOUT DETAIL

TOLERANCES ±.005
[±.12]
UNLESS OTHERWISE SPECIFIED

1. ALL DIMENSIONS ARE IN INCHES [millimeters].
2. TOLERANCE ±.020 [51] UNLESS OTHERWISE SPECIFIED.

4 | H-Series – Dimensional Specifications: in. [mm] – Curved Rocker Actuator

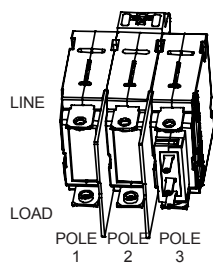
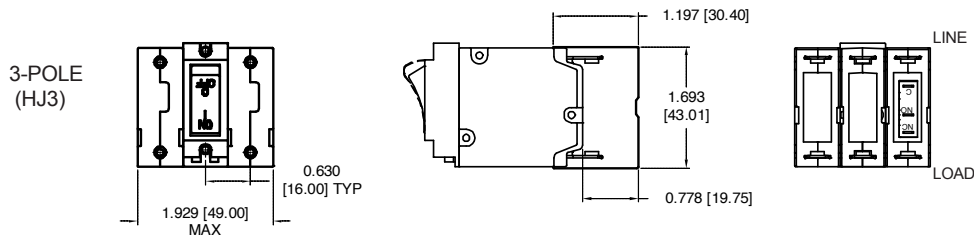
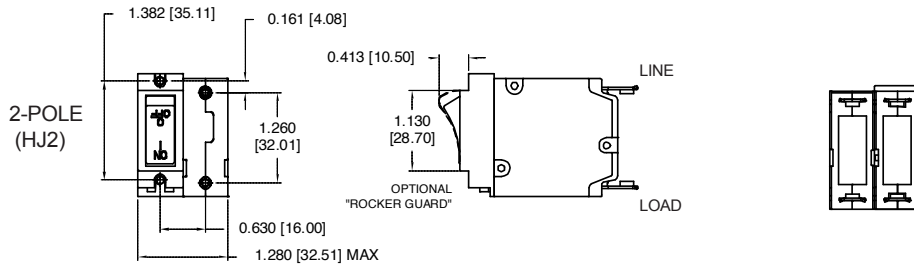
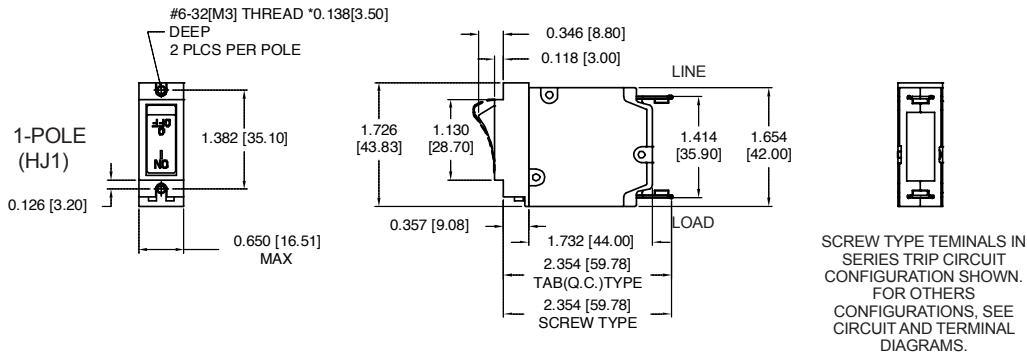

MULTI-POLE IDENTIFICATION SCHEME AS VIEWED FROM TERMINAL END OF BREAKER.

- NOTES:
1. ALL DIMENSIONS ARE IN INCHES [mm]
 2. TOLERANCE ± 0.020 [.51] UNLESS OTHERWISE SPECIFIED.

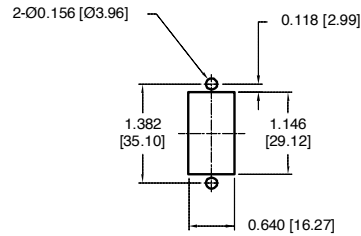

PANEL CUTOUT DETAIL
TOLERANCE ± 0.005 [±.12]
UNLESS OTHERWISE SPECIFIED

PUSH-TO-RESET ACTUATOR

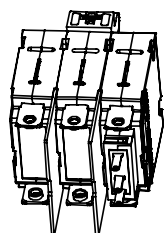
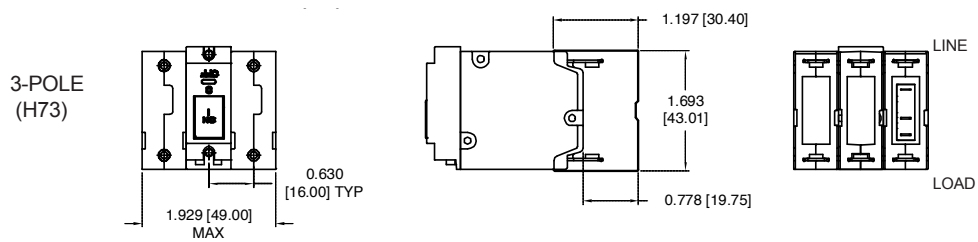
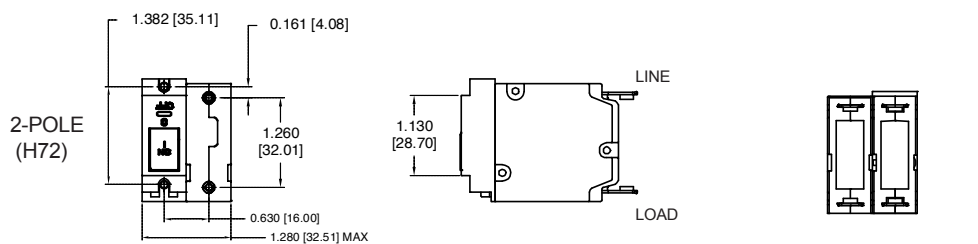
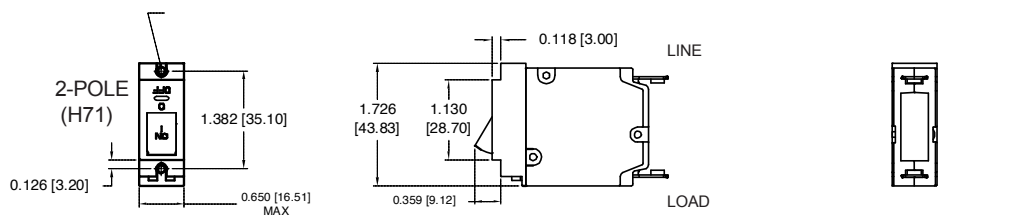
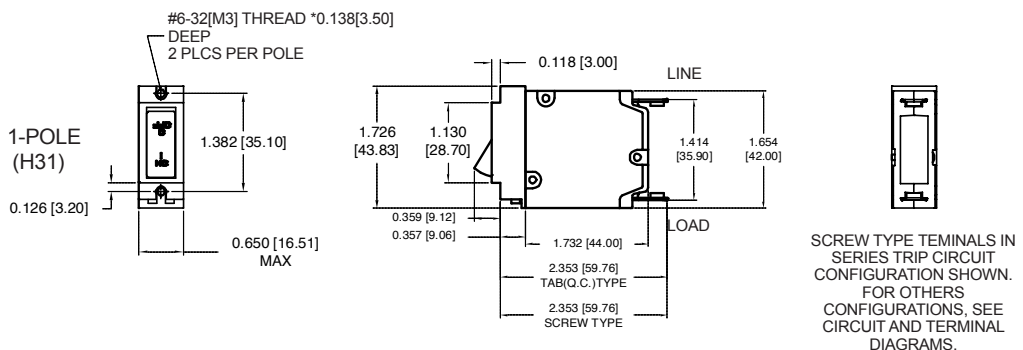

MULTI-POLE IDENTIFICATION SCHEME AS VIEWED FROM TERMINAL END OF BREAKER.

- NOTES:
1. ALL DIMENSIONS ARE IN INCHES [mm]
2. TOLERANCE ± 0.020 [0.51] UNLESS OTHERWISE SPECIFIED.

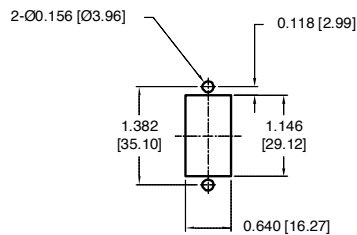

PANEL CUTOUT DETAIL TOLERANCE ± 0.005 [±.12] UNLESS OTHERWISE SPECIFIED

PRINTED CIRCUIT BOARD MOUNTING
TERMINAL CODE R

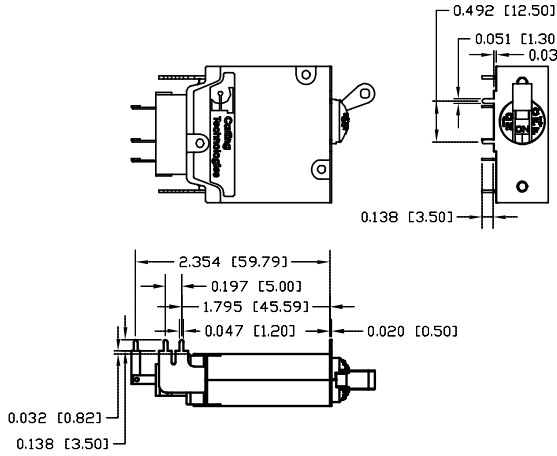

PRINTED CIRCUIT BOARD MOUNTING
TERMINAL CODE L

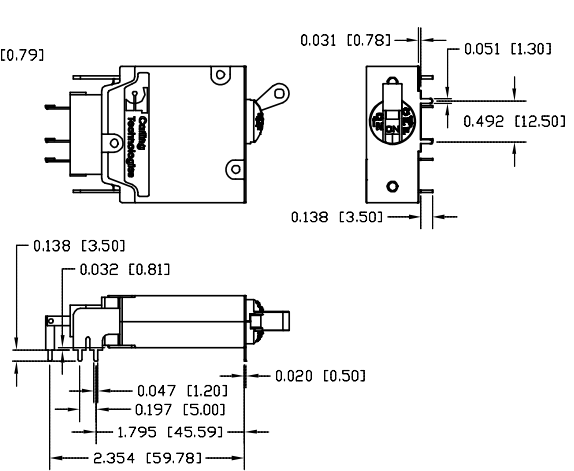

PRINTED CIRCUIT BOARD MOUNTING
TERMINAL CODE S & T

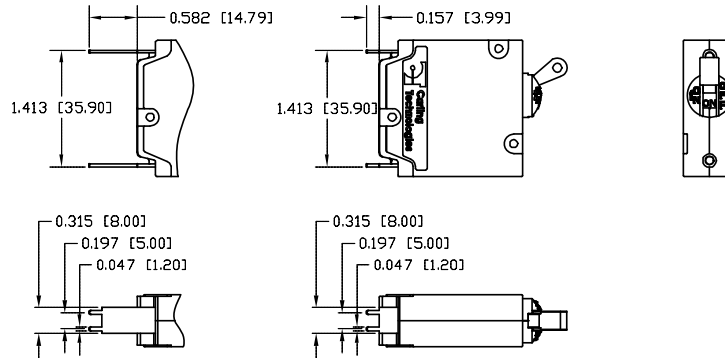

NOTES:
1. ALL DIMENSIONS ARE IN INCHES [mm]
2. TOLERANCE ± 0.020 [0.51] UNLESS OTHERWISE SPECIFIED.

P.C. FOOT PRINT
FOR TERMINAL CODE R

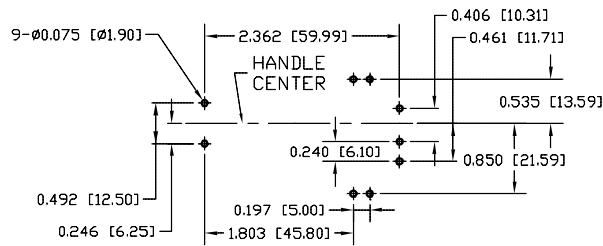

P.C. FOOT PRINT
FOR TERMINAL CODE L

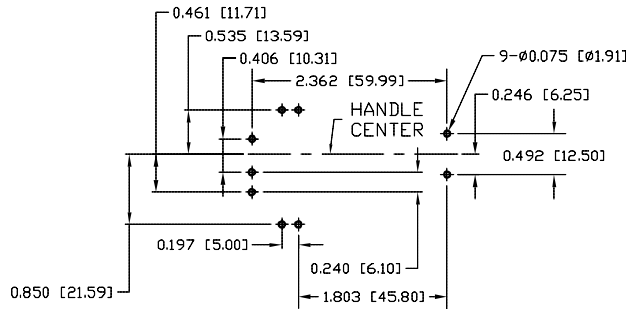

P.C. FOOT PRINT
FOR TERMINAL CODE S & T

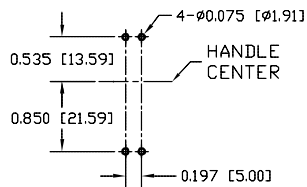

- NOTES:
1. ALL DIMENSIONS ARE IN INCHES [mm]
2. TOLERANCE ± 0.020 [.51] UNLESS OTHERWISE SPECIFIED.

HANDLE POSITION VS. AUX SWITCH MODE		
STANDARD C/B		
CIRCUIT BREAKER MODE	HANDLE POSITION	AUX. SWITCH MODE
OFF		
ON		
ELECTRICAL TRIP		

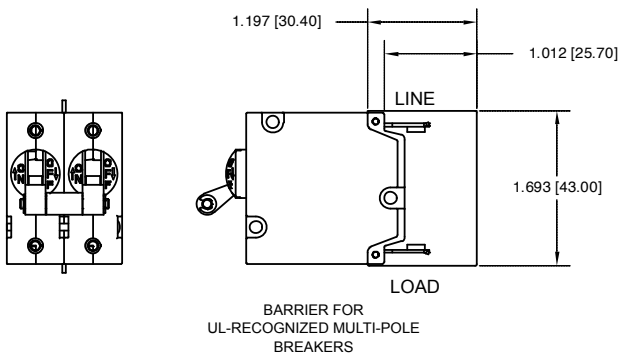
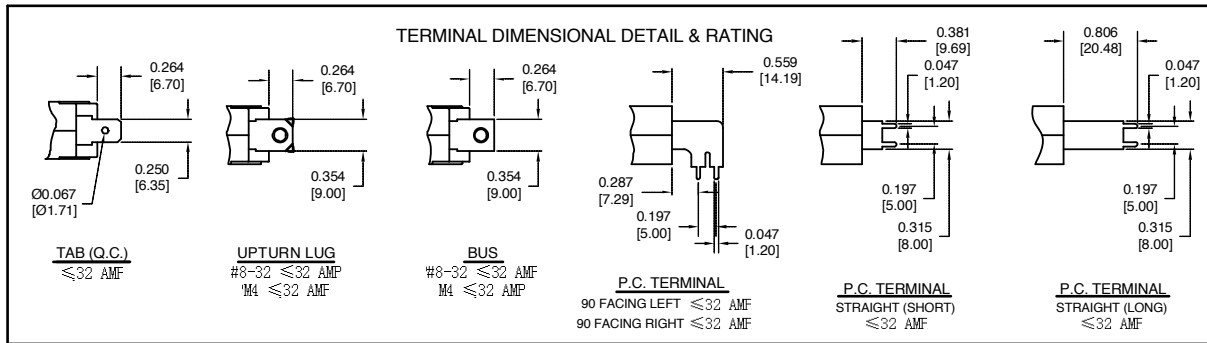
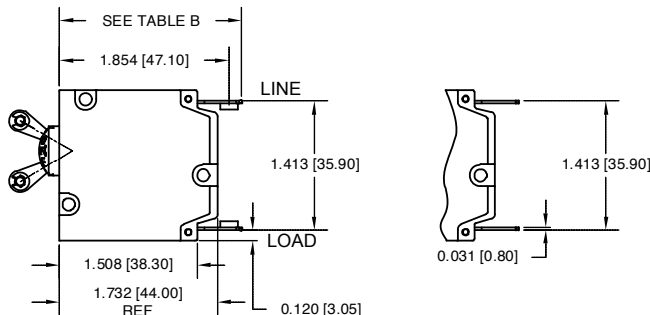

**TABLE A
TIGHTENING TORQUE SPECIFICATIONS**

THREAD SIZE	TORQUE
#6-32 & M3 MOUNTING HARDWARE	7-9 IN-LBS [0.8-1.0 NM]
#8-32 & M4 THREAD TERMINAL SCREW	12-15 IN-LBS [1.4-1.7 NM]

TABLE B

TERMINAL DESCRIPTION		DEPTH BEHIND PANEL
MAIN	TAB (Q.C.)	1.996 [50.70]
	SCREW TYPE	1.996 [50.70]
AUX. SWITCH*	.110 TAB (Q.C.)	2.467 [62.67]
	SOLDER TYPE	2.252 [57.19]



* AVAILABLE ON SERIES TRIP AND SWITCH ONLY CIRCUITS. WHEN CALLED FOR ON MULTI-POLE UNITS, ONLY ONE AUX. SWITCH IS NORMALLY SUPPLIED, AS SHOWN IN MULTI-POLE IDENTIFICATION SCHEME.

1. ALL DIMENSIONS ARE IN INCHES [mm]
2. TOLERANCE ±.020 [.51] UNLESS OTHERWISE SPECIFIED.

CIRCUIT BREAKER PROFILE	CIRCUIT SCHEMATIC		CIRCUIT CODE	AUX SWITCH CODE	CIRCUIT SCHEMATIC		CIRCUIT CODE	AUX SWITCH CODE
	ANSI	SWITCH ONLY (NO COIL)			ANSI	SERIES TRIP		
2 TERMINALS 			A	0	B,C	0		
5 TERMINALS 0.377 [9.58] 	SWITCH ONLY (NO COIL) WITH AUXILIARY SWITCH 	SERIES TRIP WITH AUXILIARY 	A	1 2 3	B,C	1 2 3		
4 TERMINALS 	RELAY TRIP 		G	0				

AUXILIARY SWITCH TERMINAL DETAIL

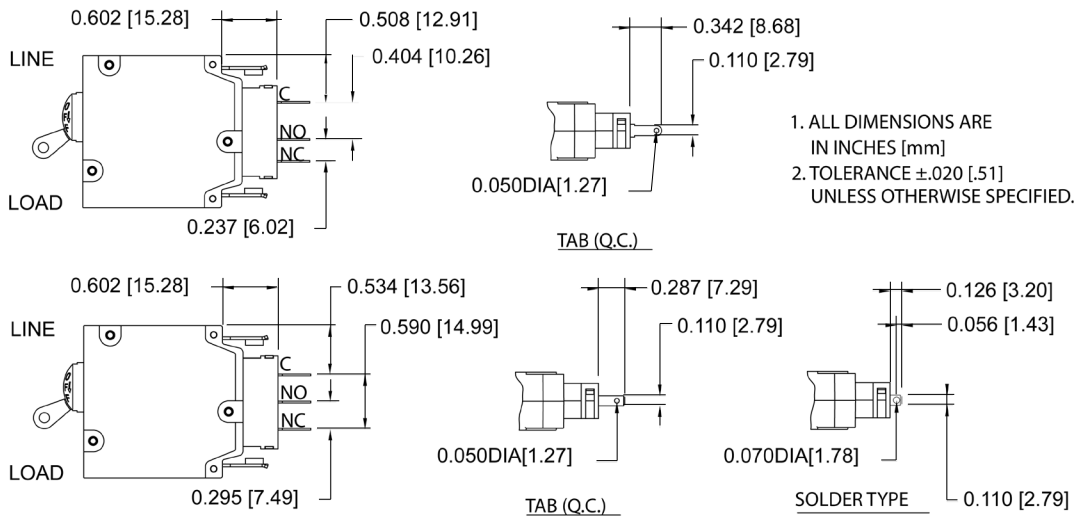

TRIP TIME (SECONDS)	PERCENT OF RATED CURRENT										
	100%	125%	135%	150%	200%	400%	600%	800%	1000%	1200%	
10	No Trip	May Trip	---	.032 MAX	.024 MAX	.020 MAX	.018 MAX	.016 MAX	.015 MAX	.013 MAX	
11	No Trip	.013 - .125	---	.010 - .070	.008 - .032	.006 - .020	.005 - .020	.004 - .020	.004 - .020	.004 - .020	
12	No Trip	.500 - 6.50	---	.300 - 3.00	.130 - 1.20	.031 - .220	.011 - .120	.004 - .090	.004 - .060	.004 - .040	
14	No Trip	2.00 - 60.0	---	1.20 - 40.0	.600 - 20.0	.150 - 3.00	.030 - 1.30	.004 - .600	.004 - .100	.004 - .100	
16	No Trip	45.0 - 345	---	20.0 - 150	9.00 - 60.0	1.40 - 11.4	.150 - 5.80	.009 - 3.70	.005 - 1.70	.005 - .500	
20	No Trip	May Trip	---	.040 MAX	.035 MAX	.030 MAX	.025 MAX	.020 MAX	.017 MAX	.015 MAX	
21	No Trip	.014 - .150	---	.011 - .095	.008 - .055	.006 - .035	.005 - .027	.005 - .021	.004 - .018	.004 - .017	
22	No Trip	.700 - 12.0	---	.350 - 4.00	.130 - 1.30	.027 - .220	.008 - .130	.004 - .090	.004 - .045	.004 - .040	
24	No Trip	10.0 - 160	---	6.00 - 60.0	2.20 - 20.0	.300 - 3.00	.050 - 1.30	.007 - .500	.005 - .060	.005 - .040	
26	No Trip	50.0 - 700	---	32.0 - 350	10.0 - 90.0	1.50 - 15.0	.500 - 7.00	.020 - 3.00	.006 - 2.00	.005 - 1.00	
42	No Trip	.700 - 12.0	---	.400 - 6.00	.180 - 2.30	.050 - 6.00	.026 - .300	.018 - .200	.014 - .150	.012 - .130	
44	No Trip	7.00 - 100	---	3.00 - 50.0	1.10 - 18.0	.220 - 3.00	.120 - 1.70	.075 - 1.20	.050 - .850	.042 - .720	
46	No Trip	50.0 - 700	---	31.0 - 350	12.0 - 150	1.50 - 20.0	.700 - 10.0	.404 - 7.90	.260 - 6.50	.198 - 5.80	
52	No Trip	.500 - 6.50	---	.340 - 4.50	.180 - 2.30	.051 - .600	.030 - .320	.018 - .220	.014 - .200	.012 - .130	
54	No Trip	1.50 - 50.0	---	.750 - 35.0	.350 - 18.0	.110 - 3.00	.070 - 1.70	.045 - 1.40	.039 - 1.30	.035 - 1.30	
56	No Trip	45.0 - 345	---	19.0 - 170	8.50 - 100	1.24 - 15.0	.410 - 9.00	.256 - 8.00	.210 - 5.50	.198 - 2.90	

NOTES:
 Delay Curves 11,12,14,16,21,22,24,26: Breakers to hold 100% and must trip at 125% of rated current and greater within the time limit shown in this curve.
 Delay Curves 10,20: Breakers to hold 100% and must trip at 150% of rated current and greater within the time limit shown in this curve.
 All Curves: Curve data shown represents breaker response at ambient temperature of 77°F (25°C) with no preloading. Breakers are mounted in standard wall-mount position.
 The minimum inrush pulse tolerance handling capability is 12 times the rated current. These values are based on a 60 Hz 1/2 cycle, 8.33 ms pulse.

Instantaneous

AC

DC

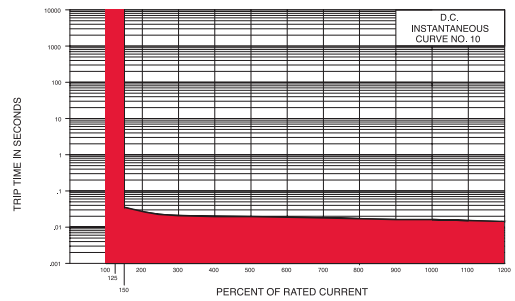
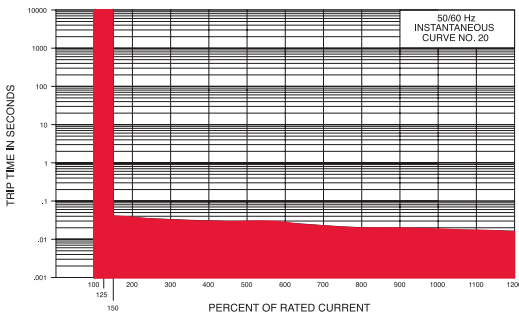

Ultrashort

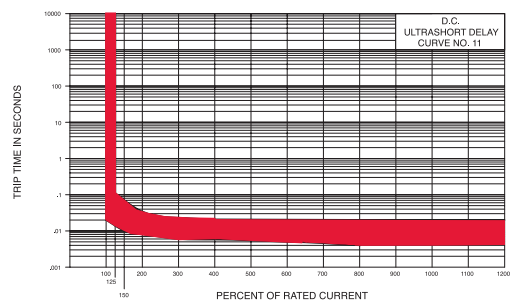
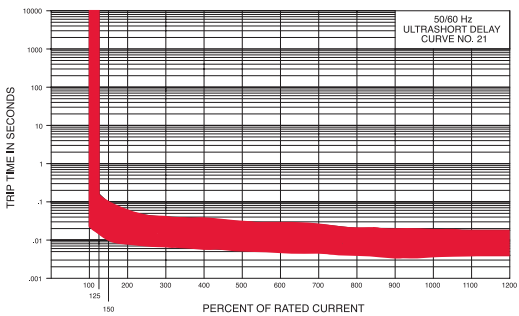

Short

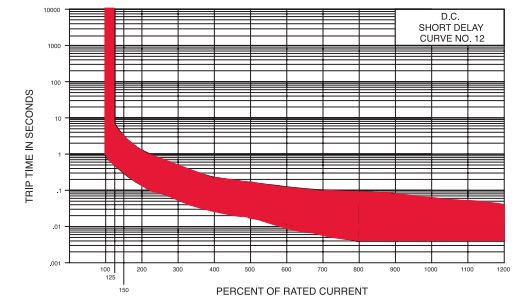
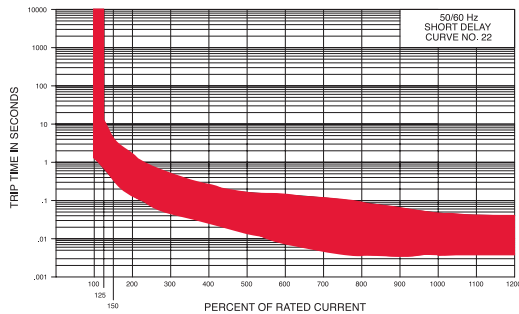

Medium

AC

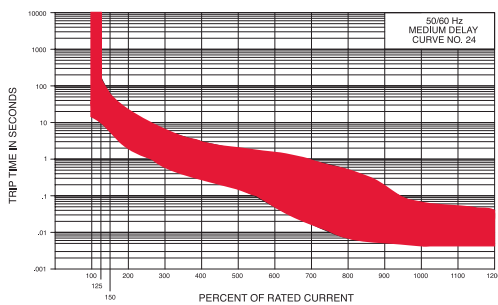

DC

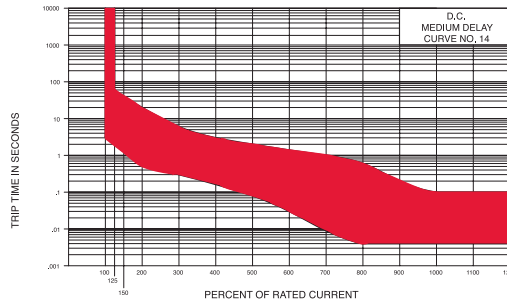

Long

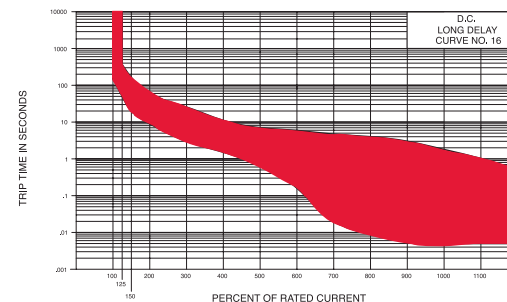
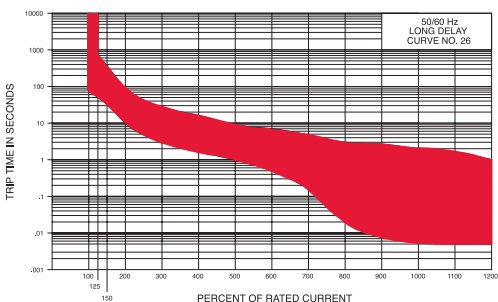

Short

High Inrush AC

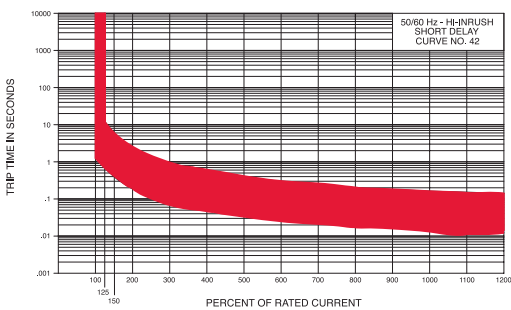

High Inrush DC

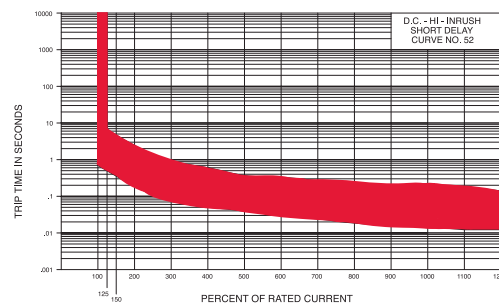

Medium

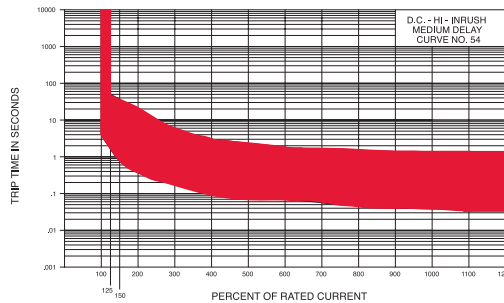
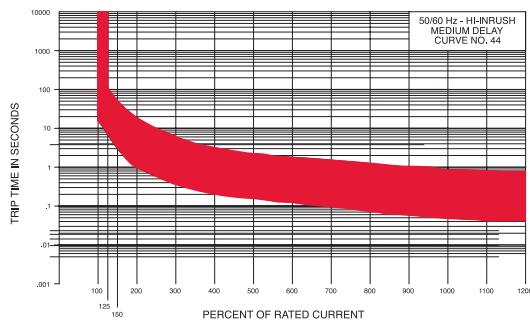

Long

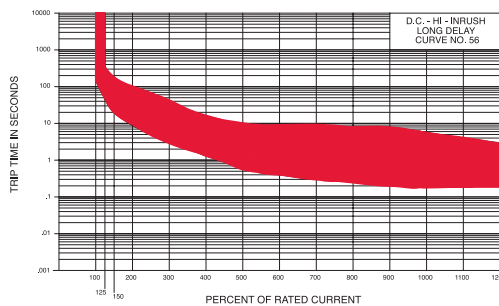
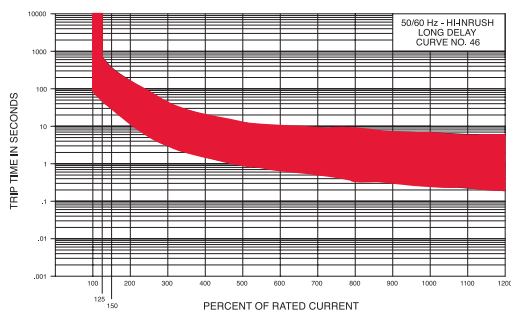

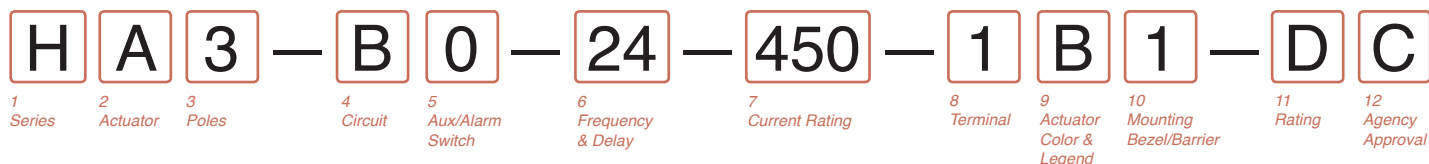

1 SERIES

H

2 ACTUATOR¹

A Handle, one per pole	B Handle, one per unit
-------------------------------	-------------------------------

3 POLE²

1 One	2 Two	3 Three
--------------	--------------	----------------

4 CIRCUIT

A Switch Only (no coil)	C⁴ Series Trip (voltage)
B Series Trip (current)	G⁴ Relay Trip (voltage)

5 AUXILIARY/ALARM SWITCH

0 w/o Aux Switch	3³ 0.110 Q.C. term w/ gold contacts
1³ 0.110 Q.C. term	4³ 0.110 PC term
2³ 0.110 Solder Lug	

6 FREQUENCY & DELAY

03 DC 50/60Hz, Switch Only	30 DC, 50/60Hz, Instantaneous
10⁴ DC Instantaneous	31 DC, 50/60Hz, Ultra Short
11 DC Ultra Short	32 DC, 50/60Hz, Short
12 DC Short	34 DC, 50/60Hz, Medium
14 DC Medium	36 DC, 50/60Hz, Long
16 DC Long	42⁴ 50/60Hz Short, Hi-Inrush
20⁴ 50/60Hz Instantaneous	44⁴ 50/60Hz Medium, Hi-Inrush
21 50/60Hz Ultra Short	46⁴ 50/60Hz Long, Hi-Inrush
22 50/60Hz Short	52⁴ DC Short, Hi-Inrush
24 50/60Hz Medium	54⁴ DC Medium, Hi-Inrush
26 50/60Hz Long	56⁴ DC Long, Hi-Inrush

7 CURRENT RATING (AMPERES)⁵

CODE	AMPERES	CODE	AMPERES	CODE	AMPERES	CODE	AMPERES
410	1.000	440	4.000	490	9.000	615	15.000
512	1.250	445	4.500	495	9.500	616	16.000
415	1.500	450	5.000	610	10.000	617	17.000
517	1.750	455	5.500	710	10.500	618	18.000
420	2.000	460	6.000	611	11.000	620	20.000
522	2.250	465	6.500	711	11.500	622	22.000
425	2.500	470	7.000	612	12.000	624	24.000
527	2.750	475	7.500	712	12.500	625	25.000
430	3.000	480	8.000	613	13.000	630	30.000
435	3.500	485	8.500	614	14.000	632	32.000

VOLTAGE RATING

CODE	RATING	TRIP VOLTS	CODE	RATING	TRIP VOLTS	CODE	RATING	TRIP VOLTS
A06	6DC	5DC	A65	65DC	55DC	J65	65AC	55AC
A12	12DC	10DC	J06	6AC	5AC	K20	120AC	65AC
A18	18DC	15DC	J12	12AC	10AC	L40	240AC	130AC
A24	24DC	20DC	J18	18AC	15AC	B10	110DC	59DC
A32	32DC	25DC	J24	24AC	20AC	B20	120DC	65DC
A48	48DC	40DC	J48	48AC	40AC			

8 TERMINAL

1 Push ON 0.250 Tab (Q.C.)		
2 Screw 8-32 w/upturned lugs	L 90 Facing Left	<i>Printed Circuitboard Terminals</i>
3 Screw 8-32 (bus type)	R 90 Facing Right	
A Screw M4 w/upturned lugs	S Straight	
B Screw M4 (bus type)	T Straight, Long	

9 ACTUATOR COLOR & LEGEND

Actuator Color	I-O	ON-OFF	Dual	Legend Color
White	A	B	1	Black
Black	C	D	2	White
Red	F	G	3	White
Green	H	J	4	White
Blue	K	L	5	White
Yellow	M	N	6	Black
Gray	P	Q	7	Black
Orange	R	S	8	Black

10 MOUNTING/BARRIERS

MOUNTING STYLE	BARRIERS	BEZEL	
Threaded Insert			
1 6-32 x 0.195 inches	no	domed	
A 6-32 x 0.195 inches	yes	domed	
2 ISO M3 x 5mm	no	domed	
B ISO M3 x 5mm	yes	domed	
3 6-32 x 0.195 inches	no	flat	
C 6-32 x 0.195 inches	yes	flat	
4 ISO M3 x 5mm	no	flat	
D ISO M3 x 5mm	yes	flat	

11 MAX. APPLICATION RATING

A 65DC	D 240AC	M 80DC ⁶	4 80VDC/250VAC ⁷
---------------	----------------	----------------------------	------------------------------------

12 AGENCY APPROVAL

A Without approvals

C UL Recognized, CSA Accepted, CCC Certified

E UL Recognized, CSA Accepted, TUV Certified

5 UL Recognized, CSA Accepted, TUV Certified, CCC Certified

- Notes:
- Actuator Option A: handle tie pin, spacer & retainers provided unassembled on multipole units.
 - Actuator Option B: Handle location as viewed from front of panel: 2 pole: left pole; 3 pole: center pole
 - Standard multipole units have all poles identical, except when specifying auxiliary switch
 - Auxiliary switch available on Series Trip and Switch Only circuits to 32A. On multipole units, only one aux. switch is normally supplied, mounted in extreme right pole.
 - Separate Pole Type Voltage Coils not rated for continuous duty. Available only with delay code 10 & 20. Only Available w/ Agency code C.
 - For other current ratings, consult factory.
 - 26-32A Polarity sensitive, only available as 1 pole unit.
 - Voltage code 4 available to 25A max.

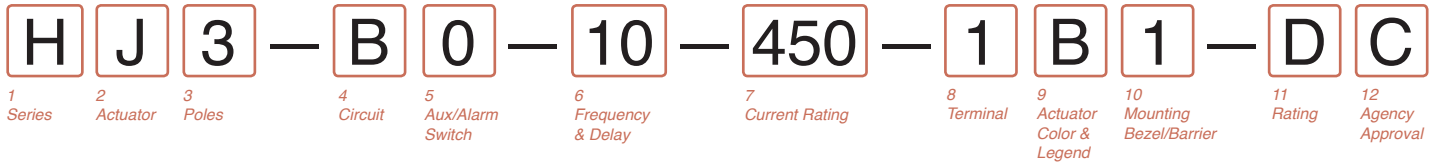

1 SERIES (VISI ROCKER)
H

2 ACTUATOR¹
J Vertical - Indicate OFF **K** Vertical - Indicate ON

3 POLE²
1 One **2** Two **3** Three

4 CIRCUIT
A Switch Only (no coil) **C⁴** Series Trip (voltage)
B Series Trip (current) **G⁴** Relay Trip (voltage)

5 AUXILIARY/ALARM SWITCH
0 w/o Aux Switch **3³** 0.110 Q.C. term w/ gold contacts
1³ 0.110 Q.C. term **4³** 0.110 PC term
2³ 0.110 Solder Lug

6 FREQUENCY & DELAY

03³ DC 50/60Hz, Switch Only	30 DC, 50/60Hz, Instantaneous
10 DC Instantaneous	31 DC, 50/60Hz, Ultra Short
11 DC Ultra Short	32 DC, 50/60Hz, Short
12 DC Short	34 DC, 50/60Hz, Medium
14 DC Medium	36 DC, 50/60Hz, Long
16 DC Long	42⁴ 50/60Hz Short, Hi-Inrush
20 50/60Hz Instantaneous	44⁴ 50/60Hz Medium, Hi-Inrush
21 50/60Hz Ultra Short	46⁴ 50/60Hz Long, Hi-Inrush
22 50/60Hz Short	52⁴ DC Short, Hi-Inrush
24 50/60Hz Medium	54⁴ DC Medium, Hi-Inrush
26 50/60Hz Long	56⁴ DC Long, Hi-Inrush

7 CURRENT RATING (AMPERES)⁵

CODE	AMPERES	CODE	AMPERES	CODE	AMPERES	CODE	AMPERES
410	1.000	450	5.000	611	11.000	621	21.000
512	1.250	455	5.500	711	11.500	622	22.000
415	1.500	460	6.000	612	12.000	623	23.000
517	1.750	465	6.500	712	12.500	624	24.000
420	2.000	470	7.000	613	13.000	625	25.000
522	2.250	475	7.500	614	14.000	626	26.000
425	2.500	480	8.000	615	15.000	627	27.000
527	2.750	485	8.500	616	16.000	628	28.000
430	3.000	490	9.000	617	17.000	629	29.000
435	3.500	495	9.500	618	18.000	630	30.000
440	4.000	610	10.000	619	19.000	632	32.000
445	4.500	710	10.500	620	20.000		

VOLTAGE RATING

CODE	RATING	TRIP VOLTS	CODE	RATING	TRIP VOLTS	CODE	RATING	TRIP VOLTS
A06	6DC	5DC	A65	65DC	55DC	J65	65AC	55AC
A12	12DC	10DC	J06	6AC	5AC	K20	120AC	65AC
A18	18DC	15DC	J12	12AC	10AC	L40	240AC	130AC
A24	24DC	20DC	J18	18AC	15AC	B10	110DC	59DC
A32	32DC	25DC	J24	24AC	20AC	B20	120DC	65DC
A48	48DC	40DC	J48	48AC	40AC			

8 TERMINAL

1 Push ON 0.250 Tab (Q.C.)		L 90 Facing Left
2 Screw 8-32 w/upturned lugs		R 90 Facing Right
3 Screw 8-32 (bus type)		S Straight
A Screw M4 w/upturned lugs		T Straight, Long
B Screw M4 (bus type)		

Printed Circuitboard Terminals

9 ACTUATOR COLOR & LEGEND

Actuator Color	I-O	ON-OFF	Dual
White	A	B	2
Red	F	G	3
Green	H	J	4
Blue	K	L	5
Yellow	M	N	6
Gray	P	Q	7
Orange	R	S	8

10 MOUNTING/BARRIERS⁵

	MOUNTING STYLE	BARRIERS	HALF ROCKER GUARD	BRACKET COLOR
	Threaded Insert			
1	6-32 x 0.195 inches	no	no	Black
A	6-32 x 0.195 inches	yes	no	Black
2	ISO M3 x 5mm	no	no	Black
B	ISO M3 x 5mm	yes	no	Black
3	6-32 x 0.195 inches	no	yes	Black
C	6-32 x 0.195 inches	yes	yes	Black
4	ISO M3 x 5mm	no	yes	Black
D	ISO M3 x 5mm	yes	yes	Black
5	6-32 x 0.195 inches	no	no	White
E	6-32 x 0.195 inches	yes	no	White
6	ISO M3 x 5mm	no	no	White
F	ISO M3 x 5mm	yes	no	White
7	6-32 x 0.195 inches	no	yes	White
G	6-32 x 0.195 inches	yes	yes	White
8	ISO M3 x 5mm	no	yes	White
H	ISO M3 x 5mm	yes	yes	White
9	6-32 x 0.195 inches	no	no	Gray
J	6-32 x 0.195 inches	yes	no	Gray
P	ISO M3 x 5mm	no	no	Gray
K	ISO M3 x 5mm	yes	no	Gray
Q	6-32 x 0.195 inches	no	yes	Gray
L	6-32 x 0.195 inches	yes	yes	Gray
U	ISO M3 x 5mm	no	yes	Gray
M	ISO M3 x 5mm	yes	yes	Gray

11 MAX. APPLICATION RATING
A 65DC **D** 240AC **M** 80DC⁷ **4** 80VDC/250VAC⁸

12 AGENCY APPROVAL
A Without approvals
C UL Recognized, CSA Accepted
E UL Recognized, CSA Accepted, TUV Certified
5 UL Recognized, CSA Accepted, TUV Certified, CCC Certified

- Notes:
- Half guard construction have OFF protection for actuator
 - Standard multipole units have all poles identical, except when specifying auxiliary switch
 - Auxiliary switch available on Series Trip and Switch Only circuits to 32A. On multipole units, only one aux. switch is normally supplied, mounted in extreme right pole.
 - Separate Pole Type Voltage Coils not rated for continuous duty. Available only with delay code 10 & 20. Only Available w/ Agency code C.
 - For other current ratings, consult factory.
 - On Visi-Rocker, Visi portion of rocker cannot be the same color as the bezel. Remainder of rocker same color as bezel.
 - 26-32A Polarity sensitive, only available as 1 pole unit.
 - Voltage code 4 available to 25A max.

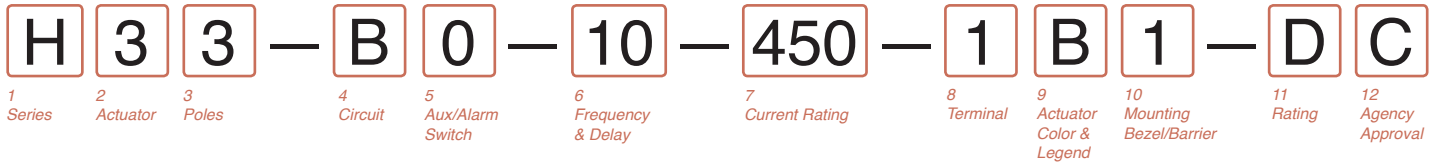

1 SERIES
H

2 ACTUATOR¹
3 Single Color Vertical 7 Push-to-Reset, Single Color Vertical
4 Single Color Horizontal 8 Push-to-Reset, Single Color Horizontal

3 POLE²
1 One 2 Two 3 Three

4 CIRCUIT
A Switch Only (no coil) C⁴ Series Trip (voltage)
B Series Trip (current) G⁴ Relay Trip (voltage)

5 AUXILIARY/ALARM SWITCH
0 w/o Aux Switch 3³ 0.110 Q.C. term w/ gold contacts
1³ 0.110 Q.C. term 4³ 0.110 PC term
2³ 0.110 Solder Lug

6 FREQUENCY & DELAY
03³ DC 50/60Hz, Switch Only 30 DC, 50/60Hz, Instantaneous
10 DC Instantaneous 31 DC, 50/60Hz, Ultra Short
11 DC Ultra Short 32 DC, 50/60Hz, Short
12 DC Short 34 DC, 50/60Hz, Medium
14 DC Medium 36 DC, 50/60Hz, Long
16 DC Long 42⁴ 50/60Hz Short, Hi-Inrush
20 50/60Hz Instantaneous 44⁴ 50/60Hz Medium, Hi-Inrush
21 50/60Hz Ultra Short 46⁴ 50/60Hz Long, Hi-Inrush
22 50/60Hz Short 52⁴ DC Short, Hi-Inrush
24 50/60Hz Medium 54⁴ DC Medium, Hi-Inrush
26 50/60Hz Long 56⁴ DC Long, Hi-Inrush

7 CURRENT RATING (AMPERES)⁵

CODE	AMPERES						
410	1.000	450	5.000	611	11.000	621	21.000
512	1.250	455	5.500	711	11.500	622	22.000
415	1.500	460	6.000	612	12.000	623	23.000
517	1.750	465	6.500	712	12.500	624	24.000
420	2.000	470	7.000	613	13.000	625	25.000
522	2.250	475	7.500	614	14.000	626	26.000
425	2.500	480	8.000	615	15.000	627	27.000
527	2.750	485	8.500	616	16.000	628	28.000
430	3.000	490	9.000	617	17.000	629	29.000
435	3.500	495	9.500	618	18.000	630	30.000
440	4.000	610	10.000	619	19.000	632	32.000
445	4.500	710	10.500	620	20.000		

VOLTAGE RATING

CODE	RATING	TRIP VOLTS						
A06	6DC	5DC	A65	65DC	55DC	J65	65AC	55AC
A12	12DC	10DC	J06	6AC	5AC	K20	120AC	65AC
A18	18DC	15DC	J12	12AC	10AC	L40	240AC	130AC
A24	24DC	20DC	J18	18AC	15AC	B10	110DC	59DC
A32	32DC	25DC	J24	24AC	20AC	B20	120DC	65DC
A48	48DC	40DC	J48	48AC	40AC	X01	65AC	special catalog #

8 TERMINAL
1 Push ON 0.250 Tab (Q.C.) L 90 Facing Left
2 Screw 8-32 w/upturned lugs R 90 Facing Right
3 Screw 8-32 (bus type) S Straight
A Screw M4 w/upturned lugs T Straight, Long
B Screw M4 (bus type)

9 ACTUATOR COLOR & LEGEND

Actuator Color	I-O	ON-OFF	Dual	Legend Color
White	A	B	1	Black
Black	C	D	2	White
Red	F	G	3	White
Green	H	J	4	White
Blue	K	L	5	White
Yellow	M	N	6	Black
Gray	P	Q	7	Black
Orange	R	S	8	Black

10 MOUNTING/BARRIERS⁵

MOUNTING STYLE	BARRIERS	PUSH-TO-RESET	BRACKET COLOR
Threaded Insert			
1 6-32 x 0.195 inches	no	no	Black
A 6-32 x 0.195 inches	yes	no	Black
2 ISO M3 x 5mm	no	no	Black
B ISO M3 x 5mm	yes	no	Black
3 6-32 x 0.195 inches	no	yes	Black
C 6-32 x 0.195 inches	yes	yes	Black
4 ISO M3 x 5mm	no	yes	Black
D ISO M3 x 5mm	yes	yes	Black
5 6-32 x 0.195 inches	no	no	White
E 6-32 x 0.195 inches	yes	no	White
6 ISO M3 x 5mm	no	no	White
F ISO M3 x 5mm	yes	no	White
7 6-32 x 0.195 inches	no	yes	White
G 6-32 x 0.195 inches	yes	yes	White
8 ISO M3 x 5mm	no	yes	White
H ISO M3 x 5mm	yes	yes	White
9 6-32 x 0.195 inches	no	no	Gray
J 6-32 x 0.195 inches	yes	no	Gray
P ISO M3 x 5mm	no	no	Gray
K ISO M3 x 5mm	yes	no	Gray
Q 6-32 x 0.195 inches	no	yes	Gray
L 6-32 x 0.195 inches	yes	yes	Gray
U ISO M3 x 5mm	no	yes	Gray
M ISO M3 x 5mm	yes	yes	Gray

11 MAX. APPLICATION RATING
A 65DC D 240AC M 80DC⁷ 4 80VDC/250VAC⁸

12 AGENCY APPROVAL
A Without approvals
C UL Recognized, CSA Accepted, CCC Certified
E UL Recognized, CSA Accepted, TUV Certified
5 UL Recognized, CSA Accepted, TUV Certified, CCC Certified

Notes:
1 Push-To-Reset actuator shave OFF portion of rocker shrouded
2 Standard multipole units have all poles identical, except when specifying auxiliary switch
3 Auxiliary switch available on Series Trip and Switch Only circuits to 32A. On multipole units, only one aux. switch is normally supplied, mounted in extreme right pole.
4 Separate Pole Type Voltage Coils not rated for continuous duty. Available only with delay code 10 & 20. Only Available w/ Agency code C.
5 For other current ratings, consult factory.
6 On Visi-Rocker, Visi portion of rocker cannot be the same color as the bezel. Remainder of rocker same color as bezel.
7 26-32A Polarity sensitive, only available as 1 pole unit.
8 Voltage code 4 available to 25A max.

* Intentionally left blank

Worldwide Headquarters

Carling Technologies, Inc.
60 Johnson Avenue • Plainville, CT 06062-1177
Phone: (860) 793-9281 • Fax: (860) 793-9231
Email: sales@carlingtech.com • www.carlingtech.com

East Region Sales Office, CT • ersm@carlingtech.com
Midwest Region Sales Office, IL • mrsms@carlingtech.com
West Region Sales Office, CA • wrsm@carlingtech.com

Asia-Pacific Headquarters

Carling Technologies, Asia-Pacific Ltd.,
Kowloon, Hong Kong
Int + 852-2737-2277 • Fax: Int + 852-2736-9332
Email: sales@carlingtech.com.hk

Shenzhen, China • shenzhen@carlingtech.com
Shanghai, China • shanghai@carlingtech.com
Pune, India • india@carlingtech.com
Kaohsiung, Taiwan • taiwan@carlingtech.com
Yokohama, Japan • japan@carlingtech.com

Europe / Middle East / Africa Headquarters

Carling Technologies, Ltd.,
Devon, England 06062-1177
Int + 44 1392-364422 • Fax: Int + 44 1392-364477
Email: ltd.sales@carlingtech.com

GmbH, Germany • gmbh@carlingtech.com
SAS, France • sas@carlingtech.com

REV_CB_H_0212



Carling Technologies™

Innovative Designs. Powerful Solutions.

Innovative Designs. Powerful Solutions.