

# Transportation Switches & Controls



# Experts in Total Vehicle Control



Multi-function Displays

Gateways

Power Management Modules

Navigation Instruments





Carling Technologies World Headquarters,  
Plainville, CT, USA



Carling Technologies, Brownsville, TX, USA



Carling Technologies, Matehuala, Mexico



Carling Technologies, Zhongshan, China

## Customer Care Center

For additional application assistance, we urge you to consult with our experienced staff in our Customer Care Center. Our Technical and Engineering staff has extensive test, research and development capabilities, and have assisted many customers in solving unique design and application problems with standard or customized products. Please refer to our location listing on the back of this catalog, for contact information for your area.

We look forward to working with you.

[www.carlingtech.com](http://www.carlingtech.com)

	page
Product Selector Guide	2
<b>V-Series Contura Sealed Rocker Switches &amp; Illuminated Indicator</b>	<b>4</b>
V-Series Contura Product Specifications & Dimensions	5
V-Series Contura II & III Sealed Rocker Switches	12
V-Series Contura II & III Locking Sealed Rocker Switches	13
V-Series Contura IV Sealed Rocker Switches	14
V-Series Contura V Sealed Rocker Switches	15
V-Series Contura IV & V Locking Sealed Rocker Switches	16
V-Series Contura VI WAVE Sealed Rocker Switches	17
V-Series Contura X, XI & XII Sealed Rocker Switches	18
V-Series Contura X Locking Sealed Rocker Switches	19
V-Series Contura Rocker Switch Actuators Only	20
V-Series Contura Rocker Switch Accessories	21
VP-Series Contura Illuminated Indicators	23
<b>W-Series Fully Sealed Rocker Switches</b>	<b>25</b>
W-Series Product Specifications & Dimensions	25
W-Series Fully Sealed Rocker Switches	28
<b>L-Series Sealed Rocker Switches &amp; Illuminated Indicator</b>	<b>29</b>
L-Series Product Specifications & Dimensions	29
L-Series Sealed Rocker Switches	36
L-Series Sealed Locking Rocker Switches	37
LP-Series Illuminated Indicators	38
<b>S-Series Rocker Switches</b>	<b>40</b>
S-Series Product Specifications & Dimensions	40
S-Series Rocker Switches	42
<b>N-Series Adressable Rocker Switches</b>	<b>43</b>
N-Series Product Specifications & Dimensions	43
N-Series Adressable Rocker Switches	46
<b>LD-Series Electronic Dimmer Control</b>	<b>47</b>
LD-Series Product Specifications & Dimensions	47
LD-Series Dimmer Control	48
<b>LMR-Series Mirror Rotate Control</b>	<b>49</b>
LMR-Series Product Specifications & Dimensions	49
LMR-Series Dimmer Control	49
<b>LW-Series Wiper/Washer Control</b>	<b>50</b>
LW-Series Product Specifications & Dimensions	50
LW-Series Wiper/Washer Control	51
<b>Custom Electronic Controls</b>	<b>52</b>
<b>Operator Control Modules</b>	<b>53</b>
<b>Legend Imprinting</b>	<b>54</b>

**Disclaimer:**

The product information published in this catalog is subject to change without notice. Modification of material, finishes, technical specifications and agency certification may occur as part of our continual pursuit of product enhancement. All statements, technical information, and recommendations are based on facts and tests we believe to be reliable. The products described may be used in a variety of applications. Since the user's product information, specific use of application and conditions of use are all outside of Carling Technologies' control, it is the responsibility of the purchaser to determine the suitability of these products for the purchaser's specific use and the purchaser assumes all associated risks. The purchaser should review applicable codes and standards such as UL, NEMA, CSA, VDE, OSHA and others for recommended practices and safety standards along with electrical ratings as marked on product to ensure compatibility of product performance to applicable requirements.

**Warranty Policy**

Carling Technologies, Inc. (Seller) warrants that goods sold hereunder shall be free of defects in material and workmanship for one year from date of shipment. In the event of such defects, the Seller's only obligation shall be the replacement or the cost of the defective goods, themselves, excluding, without limitation, labor costs, which are or may be required in connection with the replacement or reinstallation of the goods. This warranty is the Seller's sole obligation and excludes all other remedies or warranties, express or implied, including warranties of merchantability and fitness for a particular purpose, whether or not purposes or specifications are described herein. This Warranty expressly excludes any and all incidental, special and/or consequential damages of any nature. Seller further disclaims any responsibility for injury to person or damage to or loss of property or value caused by any product which has been subjected to misuse, negligence, or accident; or misapplied, or modified or repaired by a person or persons not authorized by the Seller or which have been improperly installed.

	V-SERIES CONTURA SWITCHES			W-SERIES	L-SERIES
					
<b>Style</b>	II, III	IV, V, VI	X, XI, XII	W	L
<b>Number of Poles</b> single double	✓ ✓	✓ ✓	✓ ✓	✓ ✓	✓ ✓
<b>Ratings</b>	dry circuit to 15A, 24VDC 15A, 125VAC 10A, 250VAC	dry circuit to 15A, 24VDC 15A, 125VAC 10A, 250VAC	dry circuit to 15A, 24VDC 15A, 125VAC 10A, 250VAC	dry circuit to 10A, 24VDC	dry circuit to 15A, 24VDC 15A, 125VAC 10A, 250VAC
<b>Actuator Type</b> rocker paddle locking joystick	✓ ✓	✓ ✓	✓ ✓ ✓	✓ ✓	✓ ✓ ✓
<b>Mounting hole Specifications</b>	1.45" x .83" [36.83mm x 21.08mm]	1.45" x .83" [36.83mm x 21.08mm]	1.45" x .83" [36.83mm x 21.08mm]	1.45" x .83" [36.83mm x 21.08mm]	1.734" x .867" [44mm x 22mm]
snap in mount	✓	✓	✓	✓	✓
<b>Rocker Style</b> bezel bezel-less	✓	✓	✓	✓	✓
<b>Termination</b> .187 tabs solder lugs .250 tabs .110 tabs wire leads	✓ ✓ ✓ ✓	✓ ✓ ✓ ✓	✓ ✓ ✓ ✓	✓	✓ ✓
<b>Number of Terminals</b>	8 or 10	8 or 10	8 or 10	10	12
<b>Sealing</b>	IP66/68 front panel	IP66/68 front panel	IP66/68 front panel	IP68 above and below panel	IP67 front panel
<b>Illumination</b> incandescent LED neon	✓ ✓ ✓	✓ ✓ ✓	✓ ✓ ✓	✓	✓ ✓
<b>Product Specs &amp; Ordering Info</b>	pages 12-13	pages 14-17	pages 18-19	pages 25-28	pages 29-38
<b>CUSTOM ELECTRONIC CONTROLS</b>					
Cruise Control	Light Control Module	Horn Control	HVAC Motor Controller		
				Page 52	

S-SERIES		N-SERIES		L-SERIES CONTROLS			
							
S		N		LD	LMR	LW	<b>Style</b>
✓ ✓		✓ ✓		✓	✓ ✓	✓ ✓	<b>Number of Poles</b> single double
10A, 24VDC		.4VA, 28VDC		10A, 14VDC 10A, 28VDC	1A, 28VDC	8A, 14VDC 1A, 28VDC	<b>Ratings</b>
✓		✓ ✓		✓ ✓	✓	✓ ✓	<b>Actuator Type</b> rocker paddle locking joystick
1.575" x .787" [40mm x 20mm]		1.734" x .867" [44mm x 22mm]		1.734" x .867" [44mm x 22mm]	1.734" x .867" [44mm x 22mm]	1.734" x .867" [44mm x 22mm]	<b>Mounting hole Specifications</b>
✓		✓		✓	✓	✓	snap in mount
✓		✓		✓	✓	✓	<b>Rocker Style</b> bezel bezel-less
✓		✓		✓	✓	✓	<b>Termination</b> .187 tabs solder lugs .250 tabs .110 tabs wire leads
10		12		3	8	8	<b>Number of Terminals</b>
		IP67 front panel					<b>Sealing</b>
✓ in up to 3 positions pages 40-42		✓ pages 43-46		✓ pages 47-48	✓ page 49	✓ pages 50-51	<b>Illumination</b> incandescent LED neon
<b>OPERATOR CONTROL MODULES</b>						<b>LEGEND IMPRINTING</b>	
Keypads		Multiplexed V-Series Rocker Modules					
						Page 53	
							Pages 54-65



## V-Series Contura Switches

V-Series switches offer countless unique options including choices for ratings, colors, illuminations and symbols. These switches feature removable actuators in a choice of actuator styles and colors, and are available in single or double pole configurations. The V-Series switches can be illuminated with either square, oval and/or bar shaped lenses.



### Contura II

The Contura II actuators are constructed of thermoplastic polycarbonate, & are offered with either a hard nylon overlay, or a “soft-touch” elastomer overlay. The Contura II incorporates an aesthetic design of two rows of raised “bumps” on the top & bottom of the rocker.



### Contura III

The Contura III actuators are constructed of thermoplastic polycarbonate, & are offered with either a hard nylon or a “soft-touch” elastomer overlay. The Contura III incorporates three rows of bars on the top & bottom of the rocker.



### Contura IV

The Contura IV’s “Shape to create a Shape” actuator supports the designer, by working with the curves, contours & advanced styling of the latest panel designs, flowing with these advanced curves & radii. This actuator style fits on the Contura flush bracket/bezel.



### Contura V

The symmetrically curved Contura V actuator provides the perfect complement to the Contura IV’s “Shape to create a Shape” design concept. With its flush style mounting bracket, Contura V can be mounted in between two Contura IV’s, by itself, or in groups.



### Contura VI (WAVE)

The Contura VI WAVE sealed rocker switches, when used in a row, create a uniquely appealing “wave” design on your panel. A variety of colors and finishes are available for both rocker and wave insert. Contura VI features bar and oval lenses.



### Contura X

The raised bracket/bezel on the Contura X helps prevent inadvertent actuation of the rocker, as well as preventing debris from being trapped under the actuator. This curved rocker style is available with a variety of lenses and legends.



### Contura XI

The raised bracket/bezel on the Contura XI helps prevent inadvertent actuation of the rocker, as well as preventing debris from being trapped under the actuator. This convex style rocker is available with a wide variety of lenses and legends.



### Contura XII

The Contura XII version features a paddle style actuator with the raised bracket/bezel of Contura X and XI. The contoured handle design provides intuitive recognition and ease of operation and is available with all Contura X and XI lens and legend offerings.



### Illuminated Indicator

The Illuminated Indicator is offered with removable/replaceable lamps and Contura II, III, V, or X styling. Illumination alerts the operator of essential system functions or malfunctions like: oil pressure, high temperature, fluid levels, parking brake, or general system malfunction.



### V-Series Accessories/Options

Carling Technologies also offers many V-Series accessories including connectors, mounting panels, hole plugs, panel seals, and actuator removal tools.

**Whatever your application, our Contura switches deliver the performance you demand**

— and the flexibility you need. There's no challenge these sealed switches can't help you address. Especially since they're IP66/IP68 certified, UL1500 recognized, and able to withstand temperatures from -40°C to +85°C. Never have such rugged switches been available in such attractive packages. A dazzling array of light, lens and legend options on several actuator styles, plus countless circuit combinations, and accessories to complement most any style, make our Contura switches the ideal choice for designers of today.

**Maximum Design Options with minimum inventories**

Panel redesign is a snap, requiring no tooling change, with our removable interchangeable actuators. A unique balance between aesthetics and functionality.

**Seals out water, dust and debris**

Dual seal protection locks out elements. Certified to IP66/IP68 for front panel components.

**Clean Connections**

Offered in both eight and ten terminal base options. AMP & Packard compatible connectors available.

**Withstands Extreme Temperatures**

Roller pin mechanism eliminates need for lubricants, so it can withstand from -40°C to +85°C.

**Multiple Lighting Options**

Incandescent lamps & LED lighting. Our LED illumination is offered in a wide array of light intensities, colors, as well as dual level, tri-color, and flashing options.

**Optional Panel Seal**

Prevents water/dust egress behind panel.

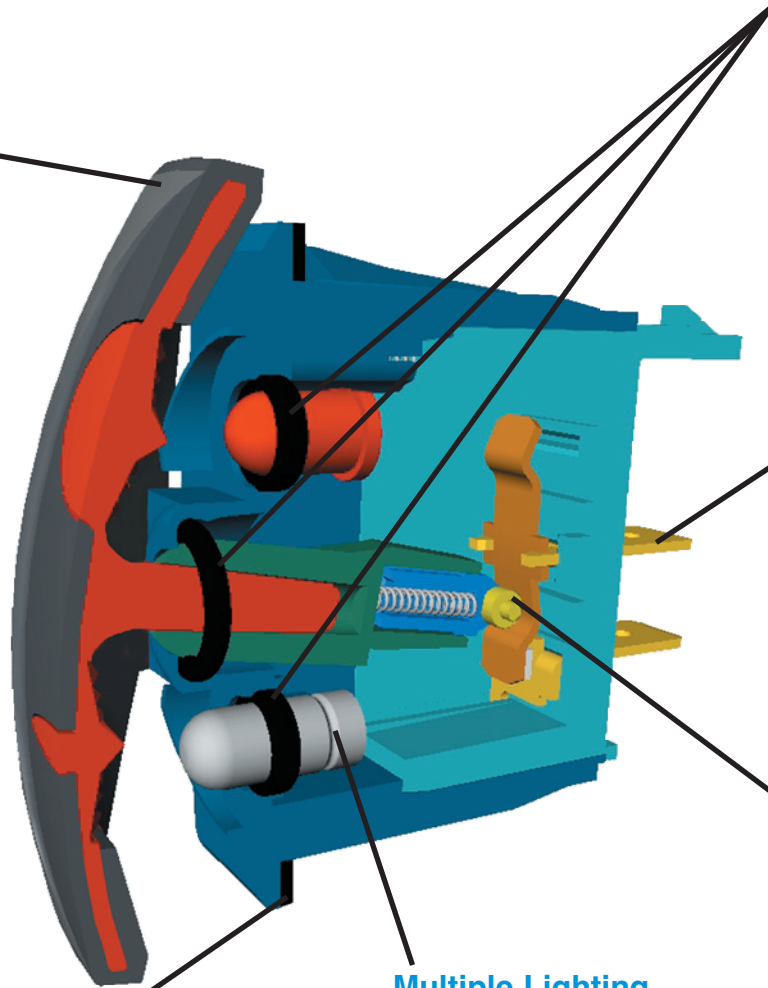

## Electrical

Contact Rating . . . . .	.4VA @ 24VDC (MAX) resistive 15 amps, 125VAC 10 amps, 250VAC 1/2 HP 125-250VAC 20 amps, 4-14VDC 15 amps, 15-28VDC 10A, 14VT 6A, 125VAC L
Dielectric Strength . . . . .	1500 Volts RMS
Insulation Resistance . . .	50 Megohms
Initial Contact Resistance.	10 milliohms max. @ 4VDC
Life . . . . .	50,000- 100,000 cycles circuit dependent
Contacts . . . . .	Silver alloy, silver tin-oxide, fine silver
Terminals . . . . .	Brass or copper/silver plate 1/4" (6.3mm) Quick Connect terminations standard. Solder lug, Wire Lead

## Mechanical

Endurance . . . . .	150,000 cycles minimum
---------------------	------------------------

## Physical

Lighted . . . . .	Incandescent - rated 10,000 hours Neon - rated 25,000 hours LED - rated 100,000 hours 1/2 life (LED is internally ballasted for voltages to 24VDC)
Seals . . . . .	Internal Optional external gasket panel seal
Base . . . . .	Polyester blend rated to 125°C with a UL flammability rating of 94V0.
Contura II, III, IV, V, VI Actuator . . . . .	Hard Surface: Basic actuator structure molded of thermoplastic polycarbonate with a hard Nylon 66 thermoplastic surface overlay. Soft Surface: Basic actuator structure molded of thermoplastic polycarbonate with an elastomer overlay.
Contura X, XI, XII Actuator, VP . . . . .	Nylon 66 Reinforced rated to 105°C
Lens . . . . .	Polycarbonate rated at 100°C

## Actuator Travel (Angular Displacement)

2 position . . . . .	18°
3 positions . . . . .	9° from center

## Mounting Specifications

Panel Thickness Range

# of gaskets	Acceptable Panel Thickness
0	.030 to .250 (.76mm to 4.76mm)
1	.030 to .109 & .147 to .157 (.76 to 2.77mm & 3.73 to 3.98mm)

Recommended: No gasket with panel thickness of .032, .062, .093, .125, .187 or .250

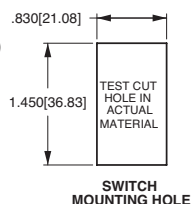

## Agency Certifications



## Environmental

Environmental . . . . .	Sealed version: IP68, in accordance with IEC 529, BS 5490, DIN 400 50 & NFC 20 010. This rating applies to front panel components of the actual switch only, and signifies protection against dust and the prolonged effects of immersion under pressure. The standard test for immersion under pressure requires submersion under one meter of water for 30 minutes. The V-Series switch has exceeded these parameters, having been actuated and illuminated during submersion. NOTE: Sealed switch with optional panel gasket will meet IP67 rating.
Corrosion . . . . .	Flowing Mixed Gas (FMG) Class III 3 year accelerated exposure per ASTM B-827, B-845 Silver and gold contacts
Operating Temperature . .	-40°C to + 85°C
Vibration 1 . . . . .	Per Mil-Std 202F, Method 204D Test Condition A 0.06 DA or 10G's 10-500 Hz. Tested with VCH connector. Test criteria - No loss of circuit during test and pre and post test contact resistance.
Vibration 2 . . . . .	Resonance search 24-50 Hz 0.40 DA 50-2000 ±10 G's peak Results Horizontal Axis 3-5 G's max. Random 24 Hz 0.06 PSD-Gsq/Hz 60 Hz 0.50 100 Hz 0.50 200 Hz 0.025 2000 Hz 0.025 No loss of circuit during test; <10µ seconds chatter.
Shock . . . . .	Per Mil-Std 202F, Method 213B, Test Condition K @ 30G's. Tested with VCH connector. Test criteria - No loss of circuit during test, pre and post test contact resistance.
Salt Spray . . . . .	Per Mil-Std 202F, Method 101D, Test Condition A, 48 Hrs. Sealed version only.
Dust . . . . .	Per Mil-Std 810C, Method 510.2 Air Velocity 300 ±200 Feet/Min, Test Duration 16 Hrs.
Thermal Shock . . . . .	Per Mil-Std 202F, Method 107F, Test Cond. A, -55°C to 85°C. Test criteria - pre and post test contact resistance
Moisture Resistance . . . .	Per Mil-Std 202F, Method 106F, Test Criteria - pre and post test contact resistance
Ignition Protection . . . . .	All Contura switches with sealed construction meet the requirements of UL1500/ISO8846 for ignition protection, in addition to conformance with EC directive 94/25/EC for marine products.



Dimensional Specifications: in. [mm]

**CONTURA II STYLE**

SHOWN WITH SQUARE LENS

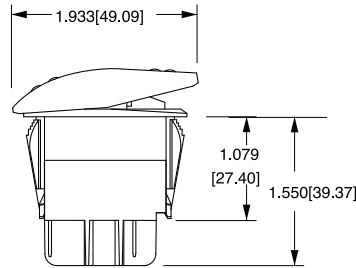
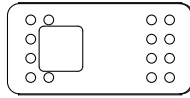

**8 TERMINAL BASE W/BARRIERS**

**CONTURA III STYLE**

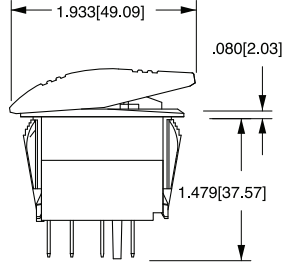
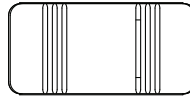

**8 TERMINAL BASE W/O BARRIERS**

**CONTURA IV STYLE**

SHOWN WITH BAR LENS

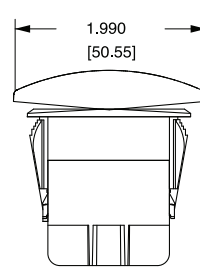
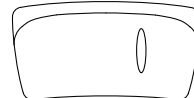

**10 TERMINAL BASE W/BARRIERS**

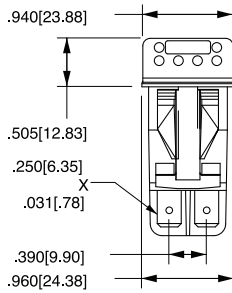

**8 TERMINAL BASE W/BARRIERS**

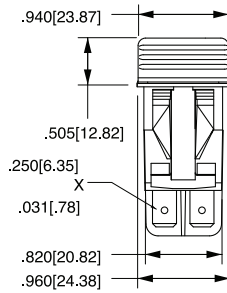

**10 TERMINAL BASE W/BARRIERS**

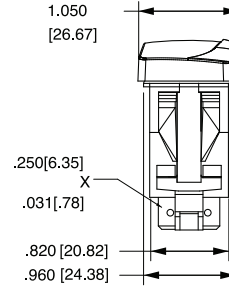

**10 TERMINAL BASE W/O BARRIERS**

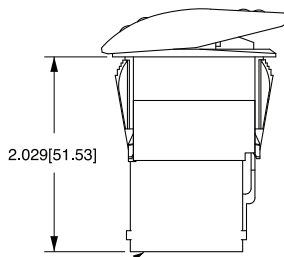

**SWITCH SHOWN WITH VCH CONNECTOR 8 TERMINAL**

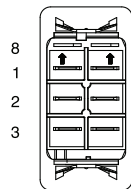

**BOTTOM VIEW TERMINAL ARRANGEMENT 8 TERMINAL BASE**

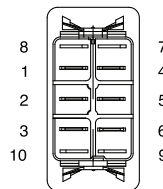

**BOTTOM VIEW TERMINAL ARRANGEMENT 10 TERMINAL BASE**

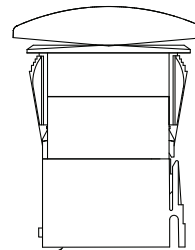

**SWITCH SHOWN WITH VC1 CONNECTOR 10 TERMINAL**

Dimensional Specifications: in. [mm]

**CONTURA V**

SHOWN WITH  
BAR LENS

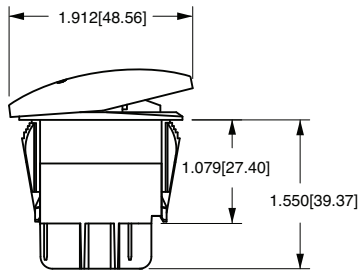
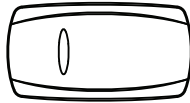

**8 TERMINAL BASE  
W/BARRIERS**

**CONTURA V**

SHOWN WITH  
LOW PROFILE LOCK

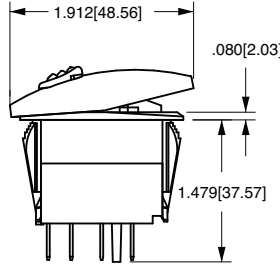
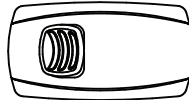

**8 TERMINAL BASE  
W/O BARRIERS**

**CONTURA VI**

SHOWN WITH OVAL  
LENS

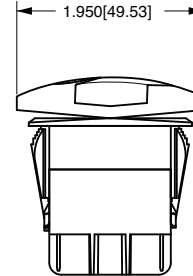
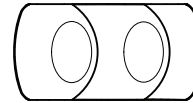

**10 TERMINAL BASE  
W/BARRIER AND  
LAMP TERMINAL**

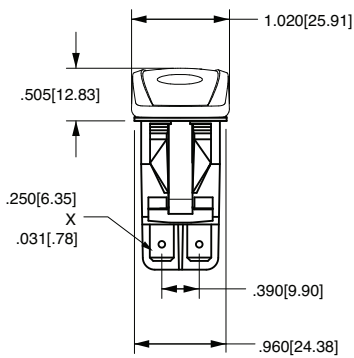

**8 TERMINAL BASE  
W/BARRIERS**

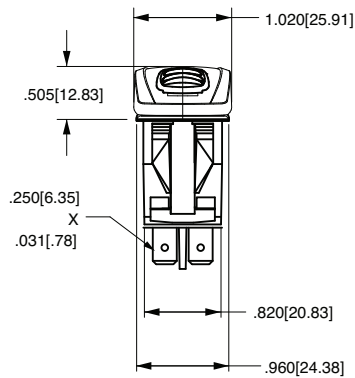

**8 TERMINAL BASE  
W/O BARRIERS**

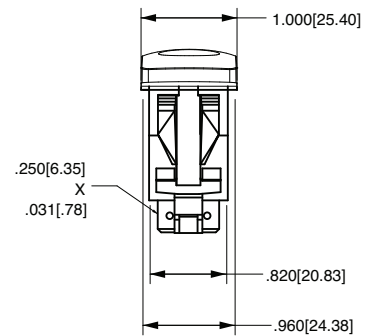

**10 TERMINAL BASE  
W/O BARRIERS**

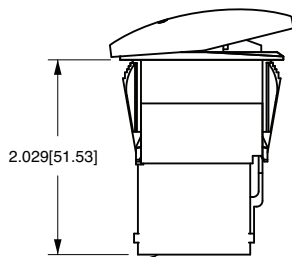

SWITCH SHOWN WITH  
VCH CONNECTOR 8  
TERMINAL

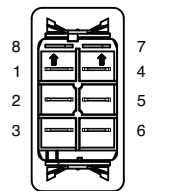

**BOTTOM VIEW  
TERMINAL  
ARRANGEMENT  
8 TERMINAL BASE**

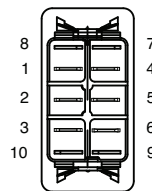

**BOTTOM VIEW  
TERMINAL  
ARRANGEMENT  
10 TERMINAL BASE**

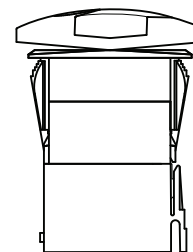

SWITCH SHOWN WITH  
VC1 CONNECTOR 10  
TERMINAL

Dimensional Specifications: in. [mm]

**CONTURA X STYLE**  
SHOWN WITH RAISED BRACKET

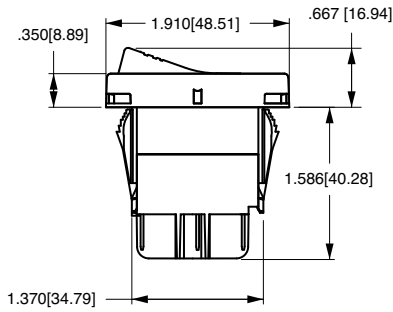
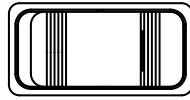

8 TERMINAL BASE  
W/BARRIERS

**CONTURA XI STYLE**  
SHOWN WITH RAISED  
BRACKET AND TWO SQUARE  
LENSES

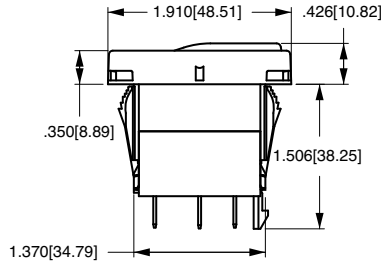
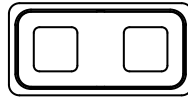

10 TERMINAL BASE  
W/O BARRIERS

**CONTURA XII STYLE**  
SHOWN WITH PADDLE  
ACTUATOR

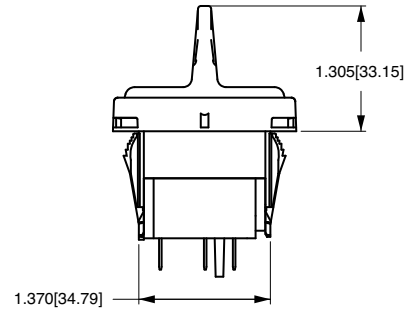
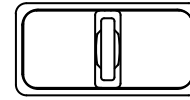

8 TERMINAL BASE  
W/O BARRIERS

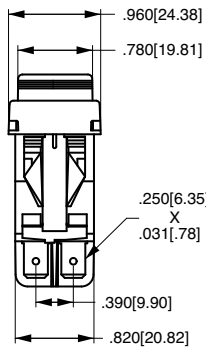

8 TERMINAL BASE  
W/BARRIERS

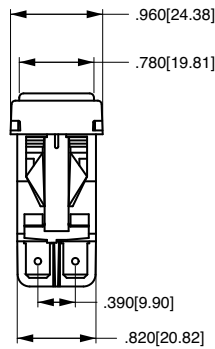

10 TERMINAL BASE  
W/BARRIERS

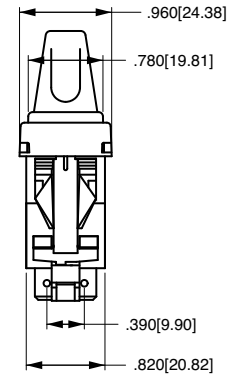

10 TERMINAL  
BASE  
W/O BARRIERS

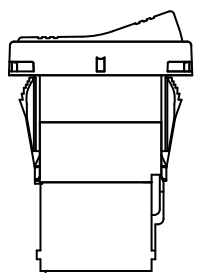

SWITCH SHOWN WITH  
VCH CONNECTOR  
8 TERMINAL

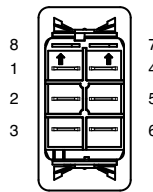

BOTTOM VIEW  
TERMINAL  
ARRANGEMENT  
8 TERMINAL BASE

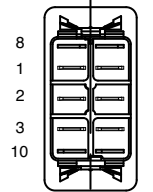

BOTTOM VIEW  
TERMINAL  
ARRANGEMENT  
10 TERMINAL BASE

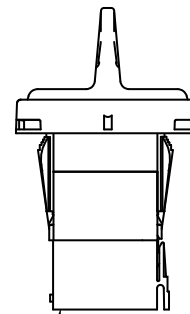

SWITCH SHOWN WITH  
VC1 CONNECTOR  
10 TERMINAL



CIRCUIT	CIRCUIT DIAGRAM
1	
2	
3	
4	
5	
6	
7	
8	

CIRCUIT	CIRCUIT DIAGRAM
A	
B	
C	
D	
E	
F	
G	
H	

CIRCUIT	CIRCUIT DIAGRAM
J	
K	
L	
M	
R	
S	

SYMBOL LEGEND	
SYM.	DEFINITION
	DESIGNATES TERMINALS AND CONTACTS
	DESIGNATES LAMP LOCATION
	DESIGNATES MAINTAINED CIRCUITS
	DESIGNATES OTHER POSITION
	DESIGNATES MOMENTARY CIRCUITS
	DESIGNATES TWO POSITION CONNECTION
	DESIGNATES EXTERNAL JUMPER PROVIDED BY CUSTOMER

# V-Series Contura Sealed Rocker Switches – Standard Lamp Circuit Diagrams

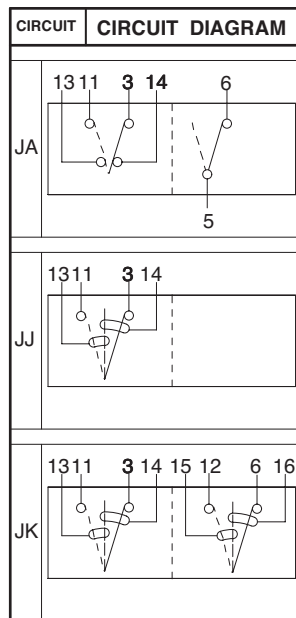
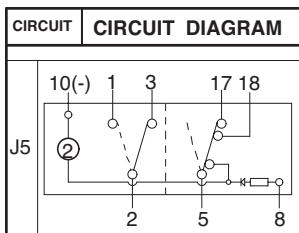
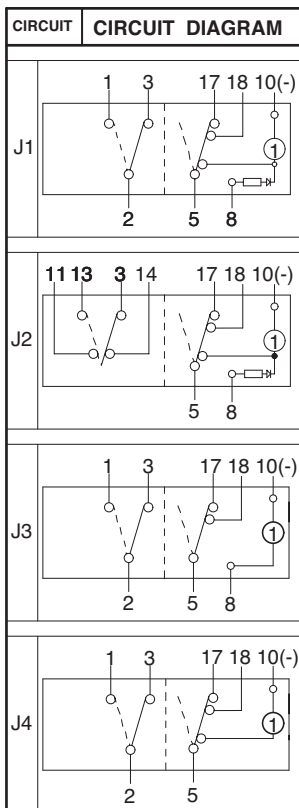
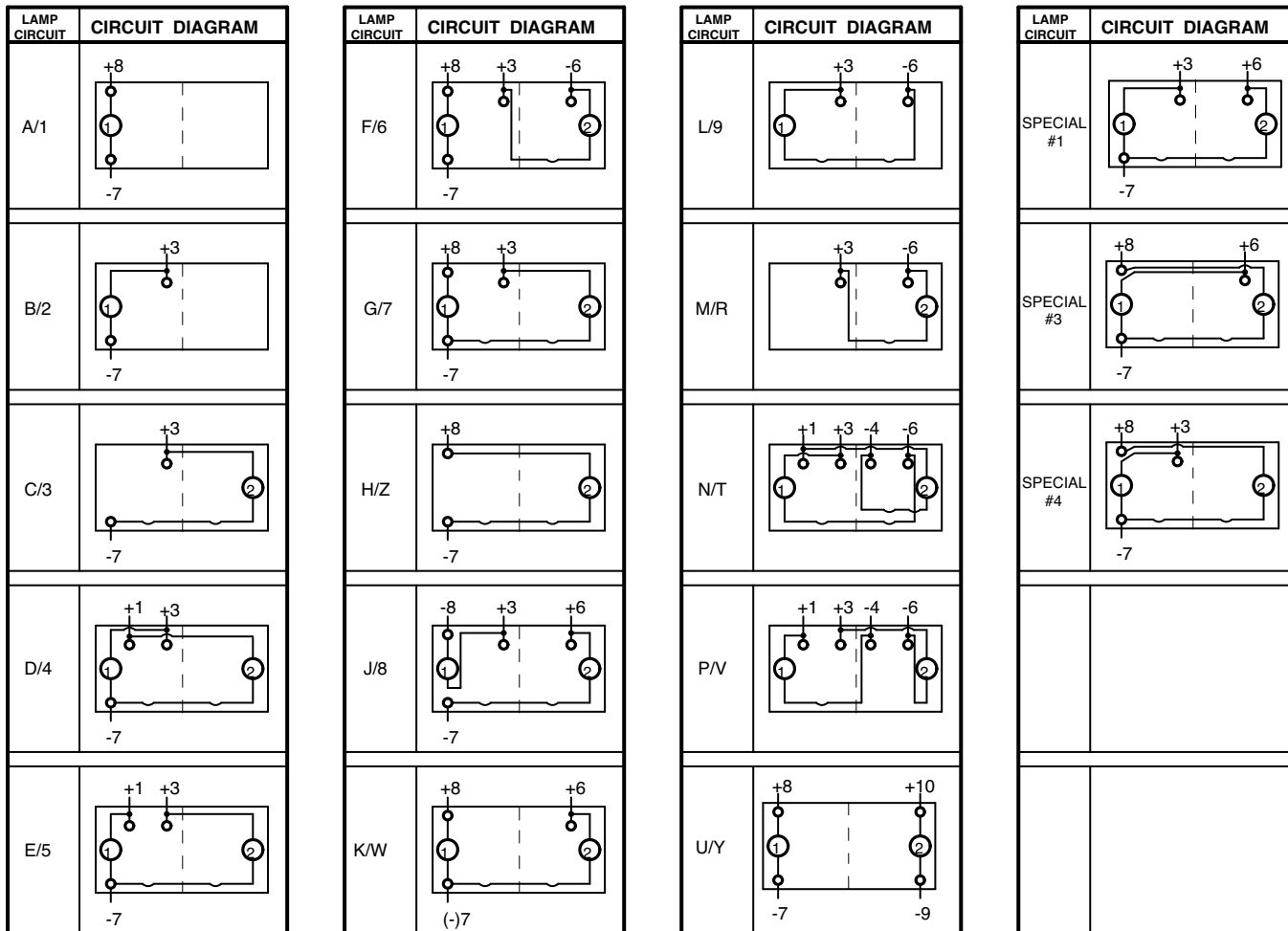

NOTE:  
J circuits are available for all non-locking V-Series styles. Simply substitute circuit number for first two digits of the part number.  
ex. V1DA500B-AZ000-000 becomes JADA500B-AZ000-000.

SYMBOL LEGEND	
SYM.	DEFINITION
○	DESIGNATES TERMINALS AND CONTACTS
○	DESIGNATES LAMP LOCATION
○	DESIGNATES TWO POSITION CIRCUIT

CIRCUIT	CONNECTOR PART #
JA, JJ, JK	JC1-01
J1, J3, J4, J5	JC2-01
J2	JC3-01

**V 1 D A B T O B - A R B 00 - 0 00**

1 Series    2 Circuit    3 Rating    4 Termination    5 Illumination    6 Lamp    7 Lamp    8 Bracket    9 Actuator    10 Lens    11 Color    12 Legend    13 Legend Orientation    14 Actuator Lens Legend

### 1 SERIES

**V**

### 2 CIRCUIT

Terminal Connections as viewed from bottom of switch:

8 terminal	10 terminal	
8 - 7	8 - 7	
1 - 4	1 - 4	
2 - 5	2 - 5	
3 - 6	3 - 6	
	10 - 9	

( ) - momentary

SP - single pole - uses terminals 1, 2 & 3.  
DP - double pole uses terminals 1, 2, 3, 4, 5 & 6.  
Terminals 7, 8, 9 & 10 for lamp circuit only.

Position:	1	2	3
SP	2 & 3, 5 & 6	Connected Terminals	1 & 2, 4 & 5
1	A	NONE	OFF
2	B	(ON)	OFF
3	C	NONE	(OFF)
4	D	ON	ON
5	F	NONE	(ON)
6	J	ON	ON
7	K	ON	(ON)
8	L	(ON)	(ON)

### SPECIAL CIRCUITS

	2 & 3	2 & 3, 5 & 6	2 & 3, 5 & 4	5 & 4
H*	2 & 3	2 & 3	2 & 3	OFF
G*	2 & 3, 5 & 6	2 & 3	2 & 3	1 & 2
S	2 & 3, 5 & 6	2 & 3	2 & 3	OFF
M*	(2 & 3, 5 & 6)	2 & 3	2 & 3	1 & 2
R*	(2 & 3, 5 & 6)	2 & 3	2 & 3	5 & 1
E*	5 & 6	5 & 3	5 & 3	5 & 1

\*Jumper between terminals 2 & 5 for circuits H, G, & M are specified in selection 4.  
External jumper between terminals 2 & 4 for circuit E are provided by customer. Circuit E may be used for SP OFF-ON circuit. Circuits H, M & E not available with ratings 5 - 9.

### 3 RATING<sup>3</sup>

<b>1</b>	.4VA @ 28VDC Resistive
<b>B</b>	15A 24V
<b>C</b>	20A 18V
<b>D</b>	20A 12V
<b>E</b>	20A 14V, 10A 14VT (circuit 1, 4, A & D only)
<b>F</b>	10A 14V, 6A 14VT (circuit 6 only)
<b>M</b>	.4VA/20A 12V
<b>N</b>	.4VA/15A 24V

### 4 TERMINATION/BASE STYLE

8 term	10 term	Termination	Jumper
<b>1</b>	<b>2</b>	.250 TAB (QC) no barriers	No
<b>A</b>	<b>B</b>	.250 TAB (QC) with barriers	No
<b>J</b>	<b>K</b>	.250 TAB (QC) no barriers	Yes T2 to 5
<b>3</b>	<b>4</b>	Solder Lug no barriers	No
<b>C</b>	<b>D</b>	Solder Lug	No
<b>5</b>	<b>6</b>	Wire Leads no barriers	No
<b>E</b>	<b>F</b>	Wire Leads	No

Note: Codes J & K for circuits H, G & M. Ratings 8 & 9 require terminations A or B only.

### 5 ILLUMINATION & SWITCH SEALING

Lamp #1: above terminals 1 & 4 end of switch.; Lamp #2 above terminals 3 & 6 end of switch.  
Positive (+) and negative (-) symbols apply to LED lamps only

Sealed	Unsealed	Lamps	Actuator Lens position when illuminated	Lamp wired to Terminals
<b>S</b>	<b>0</b>	None		
<b>A</b>	<b>1</b>	# 1	Independent	8+ 7-
<b>B</b>	<b>2</b>	# 1	Down	3+ 7-
<b>C</b>	<b>3</b>	# 2	Up	3+ 7-
<b>D</b>	<b>4</b>	# 1	Down	3+ 7-
<b>E</b>	<b>5</b>	& # 2	Down	1+ 7-
<b>F</b>	<b>6</b>	# 1	Up	1+ 7-
<b>F</b>	<b>6</b>	& # 2	Up	3+ 7-
<b>G</b>	<b>7</b>	# 1	Independent	8+ 7-
<b>G</b>	<b>7</b>	& # 2	Up	3+ 7-
<b>H</b>	<b>Z</b>	# 2	Independent	8+ 7-
<b>U</b>	<b>Y</b>	# 1	Independent	8+ 7-
<b>U</b>	<b>Y</b>	& # 2	Independent	8+ 7-
Selections for Single Pole Switches Only:				
<b>J</b>	<b>8</b>	# 1	Down	3+ 8-
<b>J</b>	<b>8</b>	& # 2	Independent	6+ 7-
<b>K</b>	<b>W</b>	# 1	Independent	8+ 7-
<b>K</b>	<b>W</b>	& # 2	Independent	6+ 7-
Selections for Double Pole Switches Only:				
<b>L</b>	<b>9</b>	# 1	Down	3+ 6-
<b>M</b>	<b>R</b>	# 2	Up	3+ 6-
<b>N</b>	<b>T</b>	# 1	Down	3+ 6-
<b>N</b>	<b>T</b>	& # 2	Down	1+ 4-
<b>P</b>	<b>V</b>	# 1	Up	1+ 4-
<b>P</b>	<b>V</b>	& # 2	Up	3+ 6-

### 6,7 LAMP ( same coding for both selections)

Selection 6: above terminals 1 & 4; Selection 7: above terminals 3 & 6

No lamp	<b>0</b>				
Neon	<b>1</b> 125VAC	<b>2</b> 250VAC			
Incandescent	<b>4</b> 3V	<b>5</b> 6V	<b>6</b> 12V	<b>7</b> 18V	<b>8</b> 24V
LED*			superbright	superbright	
	Red	Amber	Green	Red	
2VDC	<b>A</b>	<b>L</b>	<b>F</b>	<b>R</b>	
6VDC	<b>B</b>	<b>M</b>	<b>G</b>	<b>S</b>	
12VDC	<b>C</b>	<b>N</b>	<b>H</b>	<b>T</b>	
24VDC	<b>D</b>	<b>P</b>	<b>J</b>	<b>V</b>	

\*Consult factory for "daylight bright" LED options. Typical current draw for LED is 20ma.

### 8 FLUSH BRACKET COLOR<sup>1</sup>, PANEL SEAL

No Seal	Black	White	Gray
One Seal	<b>B</b>	<b>W</b>	<b>G</b>
	<b>C</b>	<b>Y</b>	<b>H</b>

### 9 ACTUATOR

No Actuator **0**

Contura II **A** 

Contura III **C** 

Actuator orientation above terminals: 3,6 1,4

### 10 LENS<sup>5</sup>

Lens color for LEDs must be clear, white, or match color of LED.  
Green or blue lenses are not recommended with Neon lamps.

**0** - No Actuator    **Z** - No Lens

Clear	White	Amber	Green	Red	Blue
<b>1</b>	<b>6</b>	<b>B</b>	<b>G</b>	<b>M</b>	<b>T</b>
<b>2</b>	<b>7</b>	<b>C</b>	<b>H</b>	<b>N</b>	<b>U</b>
<b>3</b>	<b>8</b>	<b>D</b>	<b>J</b>	<b>P</b>	<b>V</b>

Square lens options available only for Contura II:

<b>4</b>	<b>9</b>	<b>E</b>	<b>K</b>	<b>R</b>	<b>W</b>
<b>5</b>	<b>A</b>	<b>F</b>	<b>L</b>	<b>S</b>	<b>Y</b>

### 11 ACTUATOR COLOR<sup>1</sup> AND TEXTURE

**0** - No Actuator

Soft Surface	Black	Gray	Red	White
Hard Surface	<b>B</b>	<b>G</b>	<b>R</b>	<b>W</b>
	<b>C</b>	<b>H</b>	<b>S</b>	<b>Y</b>

### 12 ACTUATOR LENS OR BODY LEGENDS<sup>2</sup>

**00** - No Legend this location/No actuator

11 ON    12 OFF    13 I    14 O

OFF    ON    O    I

15 O O    16 O O    17 O I    18 I O

F N    N F

F    F

For additional legend options & codes, see pages 54-65 of this catalog.

### 13 LEGEND ORIENTATION

**0** No legend (used with codes 11-18 in selection 12)

1 Orientation 1

2 Orientation 2

3 Orientation 3

4 Orientation 4

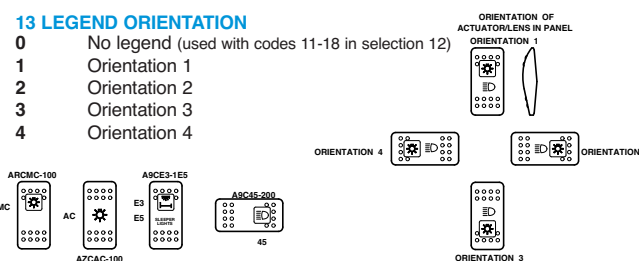

### 14 ACTUATOR LENS LEGEND<sup>2</sup>

**00** No legend this location / no actuator

(used with codes 11-18 in selection 12) Selection 14 required when switch requires two legends. If the two legends consist of one lens and one body legend, lens legend must be specified in selection 12; body legend specified in selection 14.

For legend options & codes, see pages 54-65 of this catalog

- ### NOTES
- Consult factory to verify horsepower rating for your particular circuit choice.
  - Custom colors are available. Consult factory.
  - Body legends not available on Soft surface actuators; White imprinting is standard on black actuators; Black imprinting is standard on white, red and gray actuators; Custom colors are available, consult factory.
  - Additional ratings available. See page 21.
  - Contura II available with two square lenses. Consult factory for details.



**V 1 D A S W O B - A Z E 00 - 0**

1 Series    2 Circuit    3 Rating    4 Termination    5 Illumination    6 Lock    7 Lamp    8 Bracket    9 Actuator    10 Lens    11 Function    12 Legend    13 Legend Orientation

### 1 SERIES

**V**

### 2 CIRCUIT

Terminal Connections as viewed from bottom of switch: ( ) - momentary

8 terminal	10 terminal	SP - single pole - uses terminals 1, 2 & 3.
8 - 7	8 - 7	DP - double pole uses terminals 1, 2, 3, 4, 5 & 6.
1 - 4	1 - 4	Terminals 7, 8, 9 & 10 for lamp circuit only.
2 - 5	2 - 5	
3 - 6	3 - 6	
	10 - 9	

Position:	1	2	3
SP	DP	2 & 3, 5 & 6	Connected Terminals
1	A	ON	1 & 2, 4 & 5
4	D	ON	NONE
6	J	ON	NONE
7	K	ON	OFF
8	L	(ON)	OFF
9	N	OFF	NONE

### SPECIAL CIRCUITS

H*	G*	S	M*	R	E*
2 & 3	2 & 3, 5 & 6	2 & 3, 5 & 6	(2 & 3, 5 & 6)	(2 & 3, 5 & 6)	5 & 6
2 & 3, 5 & 4	2 & 3	2 & 3	2 & 3	2 & 3	5 & 3
5 & 4	OFF	1 & 2	OFF	1 & 2	5 & 1

\*Jumper between terminals 2 & 5 for circuits H, G, & M are specified in selection 4. External jumper between terminals 2 & 4 for circuit E are provided by customer. Circuit E may be used for SP OFF-ON-ON circuit. Circuits H, M & E not available with ratings 5 - 9.

### 3 RATING<sup>3</sup>

<b>1</b>	.4VA @ 28VDC Resistive
<b>B</b>	15A 24V
<b>C</b>	20A 18V
<b>D</b>	20A 12V
<b>E</b>	20A 14V, 10A 14VT (circuit 1, 4, A & D only)
<b>F</b>	10A 14V, 6A 14VT (circuit 6 only)
<b>M</b>	.4VA/20A 12V
<b>N</b>	.4VA/15A 24V

### 4 TERMINATION/BASE STYLE

8 term	10 term	Termination	Jumper
<b>1</b>	<b>2</b>	.250 TAB (QC) no barriers	No
<b>A</b>	<b>B</b>	.250 TAB (QC) with barriers	No
<b>J</b>	<b>K</b>	.250 TAB (QC) no barriers	Yes T2 to 5
<b>4</b>	<b>4</b>	Solder Lug no barriers	No
<b>C</b>	<b>D</b>	Solder Lug	No
<b>5</b>	<b>6</b>	Wire Leads no barriers	No
<b>E</b>	<b>F</b>	Wire Leads	No

Note: Codes J & K for circuits H, G & M. Ratings 8 & 9 require terminations A or B only.

### 5 ILLUMINATION & SWITCH SEALING

Lamp #1 above terminals 1 & 4 end of switch.; Lamp #2 above terminals 3 & 6 end of switch. Positive (+) and negative (-) symbols apply to LED lamps only

Sealed	Unsealed	Lamps	Actuator Lens position when Illuminated	Lamp wired to Terminals
<b>S</b>	<b>0</b>	None		
<b>C</b>	<b>3</b>	# 2	Up	3+ 7-
<b>H</b>	<b>Z</b>	# 2	Independent	8+ 7-
Selections for Double Pole Switches Only:				
<b>M</b>	<b>R</b>	# 2	Up	3+ 6-

### 6 LOCK

Lock above terminals 1 & 4 end of switch.

**W** lock

### 7 LAMP

Lamp above terminals 3 & 6 end of switch.

No lamp	<b>0</b>				
Neon	<b>1</b>	125VAC	2 250VAC		
Incandescent	<b>4</b>	3V	5 6V	6 12V	7 18V 8 24V

LED\*    Red    Amber    Green    superbright    Red    superbright

2VDC	<b>A</b>	<b>L</b>	<b>F</b>	<b>R</b>
6VDC	<b>B</b>	<b>M</b>	<b>G</b>	<b>S</b>
12VDC	<b>C</b>	<b>N</b>	<b>H</b>	<b>T</b>
24VDC	<b>D</b>	<b>P</b>	<b>J</b>	<b>V</b>

\* Consult factory for "daylight bright" LED options. Typical current draw for LED is 20ma.

### 8 FLUSH BRACKET COLOR<sup>1</sup>, PANEL SEAL

No Seal	<b>B</b>	<b>W</b>	<b>G</b>
One Seal	<b>C</b>	<b>Y</b>	<b>H</b>

### 9 HARD SURFACE ACTUATOR<sup>1</sup>

Contura II	<b>A</b>	<b>B</b>	<b>G</b>	<b>H</b>
Contura III	<b>C</b>	<b>D</b>	<b>E</b>	<b>F</b>

Actuator orientation above terminals: 3,6    1,4

### 10 LENS

Lens color for LEDs must be clear, white, or match color of LED. Green or blue lenses are not recommended with Neon lamps.

**Z** - No Lens

Clear	<b>3</b>	<b>8</b>	<b>D</b>	<b>J</b>	<b>P</b>	<b>V</b>
White	Amber	Green	Red	Blue		

### 11 ACTUATOR LOCK FUNCTION AND COLOR<sup>1</sup>

Lock Color	Up	Down	Up & Down	Center <sup>3</sup>
Match Actuator	<b>A</b>	<b>H</b>	<b>R</b>	<b>1</b>
Black	<b>B</b>	<b>J</b>	<b>S</b>	<b>2</b>
White	<b>C</b>	<b>K</b>	<b>T</b>	<b>3</b>
Red	<b>D</b>	<b>L</b>	<b>V</b>	<b>4</b>
Safety Orange	<b>E</b>	<b>M</b>	<b>W</b>	<b>5</b>

### 12 ACTUATOR LENS OR BODY LEGEND<sup>2</sup>

**00** - No Legend

<b>21</b>	<b>22</b>	<b>23</b>	<b>24</b>
OFF	ON	O	I

<b>25</b>	<b>26</b>	<b>27</b>	<b>28</b>
O	O	O	I
F	N		

For additional legend options & codes, see pages 54-65 of this catalog

### 13 LEGEND ORIENTATION<sup>3</sup>

**0** No legend (used with codes 21-28 in selection 12)

**1** Orientation 1

**2** Orientation 2

**3** Orientation 3

**4** Orientation 4

**NOTES**

Consult factory to verify horsepower rating for your particular circuit choice.

- Custom colors are available. Consult factory.
- White imprinting is standard on black actuators; Black imprinting is standard on white, red and gray actuators; Custom colors are available, consult factory.
- Only available with 3 position circuits. Center OFF and special circuits only available with center position lock function.
- Additional ratings available. See page 21.

**V 1 D A B T O B - E R B 00 - 0 00**

1 Series    2 Circuit    3 Rating    4 Termination    5 Illumination    6 Lamp    7 Lamp    8 Bracket    9 Actuator    10 Lens    11 Color    12 Legend    13 Legend Orientation    14 Actuator Lens Legend

### 1 SERIES

**V**

### 2 CIRCUIT

Terminal Connections as viewed from bottom of switch:

8 terminal	10 terminal	( ) - momentary
8 - 7	8 - 7	SP - single pole - uses terminals 1, 2 & 3.
1 - 4	1 - 4	DP - double pole uses terminals 1, 2, 3, 4, 5 & 6.
2 - 5	2 - 5	Terminals 7, 8, 9 & 10 for lamp circuit only.
3 - 6	3 - 6	
10 - 9	10 - 9	

**Position:**

SP	DP	1	2	3
1	A	ON	2 & 3, 5 & 6	Connected Terminals 1 & 2, 4 & 5
2	B	(ON)	NONE	NONE
3	C	(ON)	NONE	OFF
4	D	ON	NONE	OFF
5	F	ON	NONE	ON
6	J	ON	OFF	ON
7	K	ON	OFF	ON
8	L	(ON)	OFF	(ON)

### SPECIAL CIRCUITS

H*	S*	M*	R*	E*
2 & 3	2 & 3, 5 & 6	2 & 3, 5 & 6	2 & 3	2 & 3
2 & 3, 5 & 6	2 & 3	2 & 3	2 & 3	2 & 3
5 & 6	5 & 3	5 & 3	5 & 3	5 & 3

\* Jumper between terminals 2 & 5 for circuits H, G, & M are specified in selection 4. External jumper between terminals 2 & 4 for circuit E are provided by customer. Circuit E may be used for SP OFF-ON-ON circuit.

### 3 RATING\*

**1** .4VA @ 28VDC Resistive  
**B** 15A 24V  
**C** 20A 18V  
**D** 20A 12V  
**E** 20A 14V, 10A 14VT (circuit 1, 4, A & D only)  
**F** 10A 14V, 6A 14VT (circuit 6 only)  
**M** .4VA/20A 12V  
**N** .4VA/15A 24V

### 4 TERMINATION/BASE STYLE

8 term	10 term	Termination	Jumper
<b>1</b>	<b>2</b>	.250 TAB (QC) no barriers	No
<b>A</b>	<b>B</b>	.250 TAB (QC) with barriers	No
<b>J</b>	<b>K</b>	.250 TAB (QC) no barriers	Yes T2 to 5
<b>3</b>	<b>4</b>	Solder Lug no barriers	No
<b>C</b>	<b>D</b>	Solder Lug	No
<b>5</b>	<b>6</b>	Wire Leads no barriers	No
<b>E</b>	<b>F</b>	Wire Leads	No

Note: Codes J & K for circuits H, G & M.

### 5 ILLUMINATION & SWITCH SEALING

Lamp #1: above terminals 1 & 4 end of switch.; Lamp #2 above terminals 3 & 6 end of switch. Positive (+) and negative (-) symbols apply to LED lamps only

Sealed	Unsealed	Lamps	Actuator Lens position when Illuminated	Lamp wired to Terminals
<b>S</b>	<b>0</b>	None		
<b>A</b>	<b>1</b>	# 1	Independent	8+ 7-
<b>B</b>	<b>2</b>	# 1	Down	3+ 7-
<b>C</b>	<b>3</b>	# 2	Up	3+ 7-
<b>D</b>	<b>4</b>	# 1	Down	3+ 7-
<b>E</b>	<b>5</b>	# 1	Down	1+ 7-
<b>F</b>	<b>6</b>	# 1	Up	3+ 7-
<b>G</b>	<b>7</b>	# 1	Independent	8+ 7-
<b>H</b>	<b>Z</b>	# 2	Independent	8+ 7-
<b>U</b>	<b>Y</b>	# 1	Independent	8+ 7-
		# 2	Independent	10+ 9-

Selections for Single Pole Switches Only:

<b>J</b>	<b>8</b>	# 1	Down	3+ 8-
<b>K</b>	<b>W</b>	# 1	Independent	6+ 7-
		# 2	Independent	8+ 7-
		# 2	Independent	6+ 7-

Selections for Double Pole Switches Only:

<b>L</b>	<b>9</b>	# 1	Down	3+ 6-
<b>M</b>	<b>R</b>	# 2	Up	3+ 6-
<b>N</b>	<b>T</b>	# 1	Down	3+ 6-
<b>P</b>	<b>V</b>	# 1	Down	1+ 4-
		# 2	Up	1+ 4-
		# 2	Up	3+ 6-

### 6,7 LAMP (same coding for both selections)

Selection 6: above terminals 1 & 4; Selection 7: above terminals 3 & 6

No lamp	<b>0</b>				
Neon	<b>1</b>	125VAC	<b>2</b>	250VAC	
Incandescent	<b>4</b>	3V	<b>5</b>	6V	<b>6</b> 12V <b>7</b> 18V <b>8</b> 24V
LED*					superbright superbright
		Red	Amber	Green	Red
2VDC	<b>A</b>	<b>L</b>	<b>F</b>	<b>R</b>	
6VDC	<b>B</b>	<b>M</b>	<b>G</b>	<b>S</b>	
12VDC	<b>C</b>	<b>N</b>	<b>H</b>	<b>T</b>	
24VDC	<b>D</b>	<b>P</b>	<b>J</b>	<b>V</b>	

\* Consult factory for "daylight bright" LED options. Typical current draw for LED is 20ma.

### 8 FLUSH BRACKET COLOR<sup>1</sup>, PANEL SEAL

No Seal	<b>B</b>	Black	<b>W</b>	White	<b>G</b>	Gray
One Seal	<b>C</b>		<b>Y</b>		<b>H</b>	

### 9 ACTUATOR

No Actuator **0**

Contura IV, left orientation **E**

Contura IV, left orientation, laser etched **T**

Contura IV, right orientation **F**

Contura IV, right orientation, laser etched **R**

Actuator orientation above terminals:

1,4	
3,6	

### 10 LENS

**0** - No Actuator

Clear	<b>6</b>	White	<b>B</b>	Amber	<b>G</b>	Green	<b>M</b>	Red	<b>T</b>	Blue	<b>U</b>
<b>1</b>	<b>7</b>	<b>2</b>	<b>8</b>	<b>3</b>	<b>9</b>	<b>4</b>	<b>5</b>	<b>A</b>	<b>F</b>	<b>L</b>	<b>S</b>
<b>Y</b>											

LENS COLOR FOR LEDs MUST BE CLEAR, WHITE, OR MATCH COLOR OF LED. Green or blue lenses are not recommended with Neon lamps.

### 11 ACTUATOR COLOR<sup>1,5,6</sup>

No Actuator **0**    Black **C**    Gray **H**    Red **S**    White **Y**    Nickel **D**    Pewter **E**

### 12 ACTUATOR LENS OR BODY LEGEND<sup>2</sup>

**00** - No Legend this location/No actuator

<b>11</b> ON	<b>12</b> OFF	<b>13</b> I	<b>14</b> O
OFF	ON	O	I

**15** O O    **16** O O    **17** O I    **18** I O

F N    N F    F

For additional legend options & codes, see pages 54-65 of this catalog

### 13 LEGEND ORIENTATION<sup>3</sup>

**0** No legend (used with codes 11-18 in selection 12)

**1** Orientation 1

**2** Orientation 2

**3** Orientation 3

**4** Orientation 4

### 14 ACTUATOR LENS LEGEND

**00** No legend this location / no actuator

(used with codes 11-18 in selection 12) Selection 14 required when switch requires two legends. If the two legends consist of one lens and one body legend, lens legend must be specified in selection 12; body legend specified in selection 14.

For legend options & codes, see pages 54-65 of this catalog

- #### NOTES
- Consult factory to verify horsepower rating for your particular circuit choice.
  - Custom colors are available. Consult factory.
  - White imprinting is standard on black actuators; Black imprinting is standard on white, red and gray actuators; Custom colors are available, consult factory.
  - Gloss brow is on left side of E actuator and right side of F actuator.
  - Additional ratings available. See page 21.
  - Laser etched rocker only available with lens code Z & actuator colors black, nickel or pewter. Pewter and nickel colors only available with laser etched actuator.

V	1	D	A	B	T	O	B	-	G	R	C	00	-	0	00
1 Series	2 Circuit	3 Rating	4 Termination	5 Illumination	6 Lamp	7 Lamp	8 Bracket		9 Actuator	10 Lens	11 Color	12 Legend		13 Legend Orientation	14 Actuator Lens Legend

**1 SERIES**  
V

**2 CIRCUIT**  
Terminal Connections as viewed from bottom of switch:  
8 terminal 10 terminal  
8 - 7 9 - 7  
1 - 4 1 - 4  
2 - 5 2 - 5  
3 - 6 3 - 6  
10 - 9

( ) - momentary  
SP - single pole - uses terminals 1, 2 & 3.  
DP - double pole uses terminals 1, 2, 3, 4, 5 & 6.  
Terminals 7, 8, 9 & 10 for lamp circuit only.

Position:	1	2	3
SP	2 & 3, 5 & 6	Connected Terminals	1 & 2, 4 & 5
1	ON	NONE	OFF
2	(ON)	NONE	OFF
3	ON	NONE	(OFF)
4	ON	NONE	ON
5	ON	NONE	(ON)
6	ON	OFF	ON
7	ON	OFF	(ON)
8	(ON)	OFF	(ON)

**SPECIAL CIRCUITS**

H*	2 & 3	2 & 3, 5 & 4	5 & 4
G*	2 & 3, 5 & 6	2 & 3	OFF
S	2 & 3, 5 & 6	2 & 3	1 & 2
M*	(2 & 3, 5 & 6)	2 & 3	OFF
R	(2 & 3, 5 & 6)	2 & 3	1 & 2
E*	5 & 6	5 & 3	5 & 1

\*Jumper between terminals 2 & 5 for circuits H, G, & M are specified in selection 4.  
External jumper between terminals 2 & 4 for circuit E are provided by customer. Circuit E may be used for SP OFF-ON-ON circuit.

**3 RATING<sup>3</sup>**

1	.4VA @ 28VDC Resistive
B	15A 24V
C	20A 18V
D	20A 12V
E	20A 14V, 10A 14VT (circuit 1, 4, A & D only)
F	10A 14V, 6A 14VT (circuit 6 only)
M	.4VA/20A 12V
N	.4VA/15A 24V

**4 TERMINATION/BASE STYLE**

8 term	10 term	Termination	Jumper
A	B	.250 TAB (QC) no barriers	No
1	2	.250 TAB (QC) with barriers	No
J	K	.250 TAB (QC) no barriers	Yes T2 to 5
3	4	Solder Lug no barriers	No
C	D	Solder Lug	No
5	6	Wire Leads no barriers	No
E	F	Wire Leads	No

Note: Codes J & K for circuits H, G & M.

**5 ILLUMINATION & SWITCH SEALING**  
Lamp #1: above terminals 1 & 4 end of switch.; Lamp #2 above terminals 3 & 6 end of switch.  
Positive (+) and negative (-) symbols apply to LED lamps only

Sealed	Unsealed	Lamps	Actuator Lens position when Illuminated	Lamp wired to Terminals
S	0	None		
A	1	# 1	Independent	8+ 7-
B	2	# 1	Down	3+ 7-
C	3	# 2	Up	3+ 7-
D	4	# 1	Down	3+ 7-
E	5	&# 2	Down	1+ 7-
F	6	# 1	Up	1+ 7-
G	7	&# 2	Up	3+ 7-
H	Z	# 1	Independent	8+ 7-
U	Y	# 2	Independent	3+ 6-
		&# 2	Up	8+ 7-
		&# 2	Up	3+ 7-
		&# 2	Independent	8+ 7-
		&# 2	Independent	8+ 7-
		&# 2	Independent	10+ 9-

**Selections for Single Pole Switches Only:**

J	8	# 1	Down	3+ 8-
		&# 2	Independent	6+ 7-
K	W	# 1	Independent	8+ 7-
		&# 2	Independent	6+ 7-

**Selections for Double Pole Switches Only:**

L	9	# 1	Down	3+ 6-
M	R	# 2	Up	3+ 6-
N	T	# 1	Down	3+ 6-
		&# 2	Down	1+ 4-
P	V	# 1	Up	1+ 4-
		&# 2	Up	3+ 6-

**6,7 LAMP (same coding for both selections)**  
Selection 6: above terminals 1 & 4; Selection 7: above terminals 3 & 6

No lamp	0				
Neon	1 125VAC	2 250VAC			
Incandescent	4 3V	5 6V	6 12V	7 18V	8 24V
LED*			superbright	superbright	superbright
	Red	Amber	Green	Red	
2VDC	A	L	F	R	
6VDC	B	M	G	S	
12VDC	C	N	H	T	
24VDC	D	P	J	V	

\* Consult factory for "daylight bright" LED options. Typical current draw for LED is 20ma.

**8 FLUSH BRACKET COLOR<sup>1</sup>, PANEL SEAL**

	Black	White	Gray
No Seal	B	W	G
One Seal	C	Y	H

**9 ACTUATOR**

No Actuator	0
Contura V	G
Contura V Laser Etch	P

**10 LENS**  
Lens color for LEDs must be clear, white, or match color of LED. Green or blue lenses are not recommended with Neon lamps.  
Lens style & location: #1 / #2

0 - No Actuator	Z - No Lens	Clear	White	Amber	Green	Red	Blue
1	6	B	G	M	T	bar	
2	7	C	H	N	U	bar/bar	
3	8	D	J	P	V	oval	
4	9	E	K	R	W	oval/bar	
5	A	F	L	S	Y	oval/oval	

**11 ACTUATOR COLOR<sup>1,3,5</sup>**

No Actuator	0	Black	C	Gray	H	Red	S
White	Y	Nickel	D	Pewter	E		

**12 ACTUATOR LENS OR BODY LEGEND<sup>2,6</sup>**

00 - No Legend this location/No actuator

11	12	OFF	13	1	14	0
OFF	ON	O	I	O	I	

15 O O 16 O O 17 O I 18 I O

F N N F F

For additional legend options & codes, see pages 54-65 of this catalog.

**13 LEGEND ORIENTATION<sup>3</sup>**

0	No legend (used with codes 11-18 in selection 12)
1	Orientation 1
2	Orientation 2
3	Orientation 3
4	Orientation 4

**14 ACTUATOR LENS LEGEND**

00 No legend this location / no actuator  
(used with codes 11-18 in selection 12) Selection 14 required when switch requires two legends. If the two legends consist of one lens and one body legend, lens legend must be specified in selection 12; body legend specified in selection 14.  
For legend options & codes, see pages 54-65 of this catalog

- NOTES**
- Consult factory to verify horsepower rating for your particular circuit choice.
  - Custom colors are available. Consult factory.
  - White imprinting is standard on black actuators; Black imprinting is standard on white, red and gray actuators; Custom colors are available, consult factory.
  - Laser Etched rocker only available with lens code Z & actuator colors black, nickel and pewter.
  - Additional ratings available. See page 21.
  - Nickel and Pewter colors only available with laser etched actuator.
  - Consult factory for laser etched lens callout.



# V-Series Contura IV & V Locking Sealed Rocker Switches

## V 1 D A S W 0 B - J Z E 00 - 0

1 Series 2 Circuit 3 Rating 4 Termination 5 Illumination 6 Lock 7 Lamp 8 Bracket 9 Actuator 10 Lens 11 Function 12 Legend 13 Legend Orientation

### 1 SERIES

V

#### 2 CIRCUIT<sup>2</sup>

Terminal Connections as viewed from bottom of switch: ( ) - momentary

8 - 7	10 - 4	SP - single pole - uses terminals 1, 2 & 3.
1 - 4	1 - 4	DP - double pole uses terminals 1, 2, 3, 4, 5 & 6.
2 - 5	2 - 5	Terminals 7 & 8 for lamp circuit only.
3 - 6	3 - 6	Terminals 9 & 10 are not used with locking style switches.
10 - 9		

**Position:**

SP	DP	1	2	3
1	A	ON	NONE	OFF
4	D	ON	NONE	ON
6	J	ON	OFF	ON
7	K	ON	OFF	(ON)
8	L	(ON)	OFF	(ON)
9	N	OFF	NONE	ON

#### 3 RATING<sup>3</sup>

1	.4VA @ 28VDC Resistive
B	15A 24V
C	20A 18V
D	20A 12V
E	20A 14V, 10A 14VT (circuit 1, 4, A & D only)
F	10A 14V, 6A 14VT (circuit 6 only)
M	.4VA/20A 12V
N	.4VA/15A 24V

#### 4 TERMINATION/BASE STYLE

8 term	10 term	Termination	Jumper
1	2	.250 TAB (QC) no barriers	No
A	B	.250 TAB (QC) with barriers	No
J	K	.250 TAB (QC) no barriers	Yes T2 to 5
3	4	Solder Lug no barriers	No
C	D	Solder Lug	No
5	6	Wire Leads no barriers	No
E	F	Wire Leads	No

Note: Codes J & K for circuits H, G & M.

#### 5 ILLUMINATION & SWITCH SEALING

Lamp above terminals 3 & 6 end of switch.  
Positive (+) and negative (-) symbols apply to LED lamps only

Sealed	Unsealed	Lamps	Actuator Lens position when Illuminated	Lamp wired to Terminals
S	0	None		
C	3	# 2	Up	3+ 7-
H	Z	# 2	Independent	8+ 7-
M	R	# 2	Up	3+ 6-

Selections for Double Pole Switches Only:

#### 6 LOCK

Lock above terminals 1 & 4 end of switch.

W	low profile lock	Y <sup>6</sup>	high profile lock
---	------------------	----------------	-------------------

#### 7 LAMP

Lamp above terminals 3 & 6 end of switch.

No lamp	0
Neon	1 125VAC 2 250VAC
Incandescent	4 3V 5 6V 6 12V 7 18V 8 24V
LED <sup>5</sup>	superbright superbright
2VDC	Red A Amber L Green F Red R
6VDC	B M G S
12VDC	C N H T

#### 8 FLUSH BRACKET COLOR<sup>1</sup>, PANEL SEAL

No Seal	Black B White W Gray G
One Seal	C Y H

#### 9 HARD SURFACE ACTUATOR

CONTURA IV:

Orientation Left	Black J	Gray K	Red L	White M
Right	N	P	R	S

Actuator orientation above terminals: 3,6 1,4

CONTURA V:

Black U	Gray V	Red W	White Y
---------	--------	-------	---------

Actuator orientation above terminals: 3,6 1,4

#### 10 LENS<sup>5</sup>

Z - No Lens

Clear	White A	Amber B	Green C	Red D	Blue E	Blue F
	H	J	K	L	M	Bar lens
						Oval Lens

Lens color for LEDs must be clear, white, or match color of LED.  
Green or blue lenses are not recommended with Neon lamps.

#### 11 ACTUATOR LOCK FUNCTION AND COLOR<sup>1</sup>

Lock Color	Up	Down	Up & Down	Center <sup>3</sup>
Match Actuator	A	H	R	1
Black	B	J	S	2
White	C	K	T	3
Red	D	L	V	4
Safety Orange	E	M	W	5
Gray	F	G	N	6

#### 12 ACTUATOR LENS OR BODY LEGEND<sup>2</sup>

00 - No Legend

21	OFF	22	ON	23	O	24	I
25	O	26	O	27	O	28	I
	F		N				

For additional legend options & codes, see pages 54-65 of this catalog.

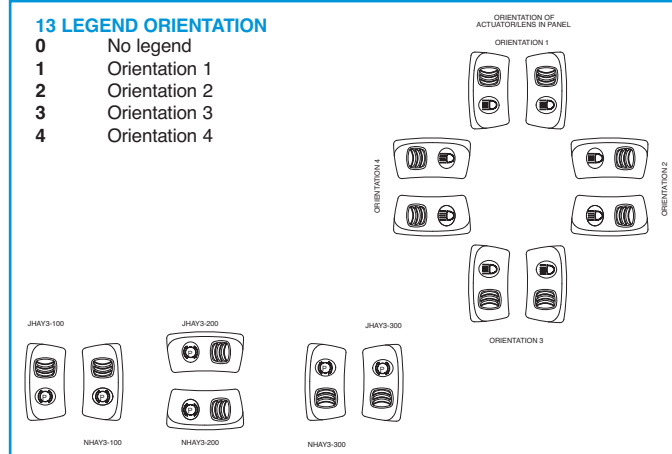

- NOTES
- Consult factory to verify horsepower rating for your particular circuit choice.
  - Custom colors are available. Consult factory.
  - White imprinting is standard on black actuators; Black imprinting is standard on white, red and gray actuators; Custom colors are available, consult factory.
  - Only available with 3 position circuits. Center OFF and special circuits only available with center position lock function.
  - Additional ratings available. See page 21.
  - Located at T3-6 end of switch.
  - Contura V style only.

**V 1 D B G N T B - H A 7 C B A C - 1 00**

1 Series 2 Circuit 3 Rating 4 Termination 5 Illumination 6 Lamp 7 Lamp 8 Bracket 9 Actuator 10 Lens 11 Lens 12 Color 13 Insert Color 14 Actuator Lens 15 Legend Orientation 16 Actuator Lens Legend

**1 SERIES**  
V

**2 CIRCUIT**  
Terminal Connections as viewed from bottom of switch:  
8 terminal 10 terminal  
1 - - 7 8 - - 7  
1 - - 4 1 - - 4  
2 - - 5 2 - - 5  
3 - - 6 3 - - 6  
10 - - 9

( ) - momentary  
SP - single pole - uses terminals 1, 2 & 3.  
DP - double pole uses terminals 1, 2, 3, 4, 5 & 6.  
Terminals 7, 8, 9 & 10 for lamp circuit only.

Position:	1	2	3
SP	DP	2 & 3, 5 & 6	Connected Terminals 1 & 2, 4 & 5
1	A	ON	NONE OFF
2	B	(ON)	NONE OFF
3	C	ON	NONE (OFF)
4	D	ON	NONE ON
5	F	ON	NONE (ON)
6	J	ON	OFF ON
7	K	ON	OFF (ON)
8	L	(ON)	OFF (ON)

**SPECIAL CIRCUITS**

	2 & 3	2 & 3, 5 & 4	5 & 4
H*	2 & 3	2 & 3	OFF
G*	2 & 3, 5 & 6	2 & 3	OFF
S	2 & 3, 5 & 6	2 & 3	1 & 2
M*	(2 & 3, 5 & 6)	2 & 3	OFF
R*	(2 & 3, 5 & 6)	2 & 3	1 & 2
E*	5 & 6	5 & 3	5 & 1

\*Jumper between terminals 2 & 5 for circuits H, G, & M are specified in selection 4.  
External jumper between terminals 2 & 4 for circuit E are provided by customer. Circuit E may be used for SP OFF-ON-ON circuit. Circuits H, M & E not available with ratings 5 - 9.

**3 RATING<sup>3</sup>**

1	.4VA @ 28VDC Resistive
B	15A 24V
C	20A 18V
D	20A 12V
E	20A 14V, 10A 14VT (circuit 1, 4, A & D only)
F	10A 14V, 6A 14VT (circuit 6 only)
M	.4VA/20A 12V
N	.4VA/15A 24V

**4 TERMINATION/BASE STYLE**

8 term	10 term	Termination	Jumper
1	2	.250 TAB (QC) no barriers	No
A	B	.250 TAB (QC) with barriers	No
J	K	.250 TAB (QC) no barriers	Yes T2 to 5
3	4	Solder Lug no barriers	No
C	D	Solder Lug	No
5	6	Wire Leads no barriers	No
E	F	Wire Leads	No

**5 ILLUMINATION & SWITCH SEALING**  
Lamp #1: above terminals 1 & 4 end of switch.; Lamp #2 above terminals 3 & 6 end of switch.  
Positive (+) and negative (-) symbols apply to LED lamps only

Sealed	Unsealed	Lamps	Actuator Lens position when illuminated	Lamp wired to Terminals
S	0	None		
A	1	# 1	Independent	8+ 7-
B	2	# 1	Down	3+ 7-
C	3	# 2	Up	3+ 7-
D	4	# 1	Down	3+ 7-
E	5	& # 2	Down	1+ 7-
F	6	# 1	Up	1+ 7-
G	7	& # 2	Up	3+ 7-
H	Z	# 1	Independent	8+ 7-
U	Y	# 2	Independent	8+ 7-
		& # 2	Independent	10+ 7-
Selections for Single Pole Switches Only:				
J	8	# 1	Down	3+ 8-
K	W	& # 2	Independent	6+ 7-
		# 1	Independent	8+ 7-
		& # 2	Independent	6+ 7-
Selections for Double Pole Switches Only:				
L	9	# 1	Down	3+ 6-
M	R	# 2	Up	3+ 6-
N	T	# 1	Down	3+ 6-
P	V	& # 2	Down	1+ 4-
		# 1	Up	1+ 4-
		& # 2	Up	3+ 6-

**6,7 LAMP ( same coding for both selections)**  
Selection 6: above terminals 1 & 4; Selection 7: above terminals 3 & 6

No lamp	0				
Neon	1	125VAC	2	250VAC	
Incandescent	4	3V	5	6V	6 12V 7 18V 8 24V
LED*					superbright superbright
		Red	Amber		Green Red
2VDC	A	L	F	R	
6VDC	B	M	G	S	
12VDC	C	N	H	T	
24VDC	D	P	J	V	

\* Consult factory for "daylight bright" LED options. Typical current draw for LED is 20ma.

**8 FLUSH BRACKET COLOR<sup>1</sup>, PANEL SEAL**

No Seal	Black	White	Gray
One Seal	B	W	H

**9 ACTUATOR**

0 No Actuator	H High Insert	L Low Insert
---------------	---------------	--------------

**10 & 11 LENS<sup>4</sup>**  
Lens color for LEDs must be clear, white, or match color of LED.  
Green or blue lenses are not recommended with Neon lamps.

0 - No Actuator	Z - No Lens					
Clear	White	Amber	Green	Red	Blue	
-	7	C	H	N	U	Bar Lens Translucent
3	-	D	J	P	V	Bar Lens Transparent
4	-	E	K	R	W	Oval Lens Translucent
-	A	F	L	S	Y	Oval Lens Transparent

**12 ACTUATOR COLOR**

C	Black	H	Gray	S	Red	Y	White
---	-------	---	------	---	-----	---	-------

**13 INSERT COLOR**

B	Black	N	Bright Nickel Plated
C	Bright Chrome Plated	S	Satin Chrome Plate
D	Satin Chrome Plated	T	Satin Nickel Plated
		W	White

**14 ACTUATOR LENS OR BODY LEGENDS<sup>2</sup>**

00 - No Legend this location/No actuator  
11 ON 12 OFF 13 I 14 O  
OFF ON O I

15 O O 16 O O 17 O I 18 I O  
F N F F F

For additional legend options & codes, see pages 54-65 of this catalog.

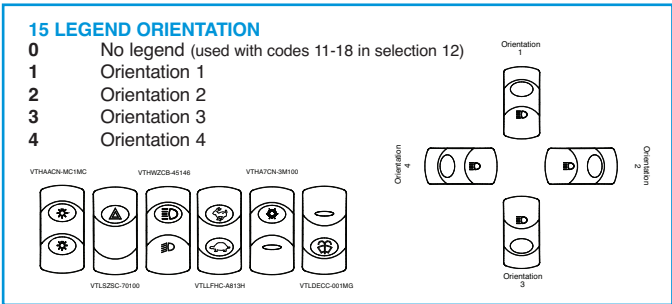

**16 ACTUATOR LENS LEGEND<sup>2</sup>**

00 No legend this location / no actuator  
(used with codes 11-18 in selection 12) Selection 16 required when switch requires two legends. If the two legends consist of one lens and one body legend, lens legend must be specified in selection 14; body legend specified in selection 16.  
For legend options & codes, see pages 54-65 of this catalog

**NOTES**  
Consult factory to verify horsepower rating for your particular circuit choice.  
1 Custom colors are available. Consult factory.  
2 White imprinting is standard on black actuators; Black imprinting is standard on white, red and gray actuators; Custom colors are available, consult factory.  
3 Additional ratings available. See page 21.

# V-Series Contura X, XI & XII Sealed Rocker Switches

V	1	D	A	B	6	0	1	-	6	P	Z	00	-	0	00
1 Series	2 Circuit	3 Rating	4 Termination	5 Illumination	6 Lamp	7 Lamp	8 Bracket	9 Actuator	10 Lens	11 Lens	12 Legend	13 Legend Orientation	14 Actuator Lens Legend		

### 1 SERIES

**V**

### 2 CIRCUIT

Terminal Connections as viewed from bottom of switch:

8 terminal	10 terminal
8 - - 7	8 - - 7
1 - - 4	1 - - 4
2 - - 5	2 - - 5
3 - - 6	3 - - 6
	10 - - 9

( ) - momentary

SP - single pole - uses terminals 1, 2 & 3.  
DP - double pole uses terminals 1, 2, 3, 4, 5 & 6.  
Terminals 7, 8, 9 & 10 for lamp circuit only.

Position:	1	2	3
SP	DP	2 & 3, 5 & 6	Connected Terminals
1	A	ON	1 & 2, 4 & 5
2	B	(ON)	NONE
3	C	(ON)	NONE
4	D	ON	NONE
5	F	ON	NONE
6	J	ON	OFF
7	K	(ON)	OFF
8	L	(ON)	OFF

### SPECIAL CIRCUITS

H*	2 & 3	2 & 3, 5 & 4	5 & 4
G*	2 & 3, 5 & 6	2 & 3	OFF
S	2 & 3, 5 & 6	2 & 3	1 & 2
M*	(2 & 3, 5 & 6)	2 & 3	OFF
R	(2 & 3, 5 & 6)	2 & 3	1 & 2
E*	5 & 6	5 & 3	5 & 1

\*Jumper between terminals 2 & 5 for circuits H, G, & M are specified in selection 4.  
External jumper between terminals 2 & 4 for circuit E are provided by customer. Circuit E may be used for SP OFF-ON-ON circuit.

### 6,7 LAMP (same coding for both selections)

Selection 6: above terminals 1 & 4; Selection 7: above terminals 3 & 6

No lamp	0
Neon <sup>5</sup>	1 125VAC 2 250VAC
Incandescent	4 3V 5 6V 6 12V 7 18V 8 24V
LED*	superbright superbright
	Green Red
2VDC	A L F R
6VDC	B M G S
12VDC	C N H T
24VDC	D P J V

\* Consult factory for "daylight bright" LED options. Typical current draw for LED is 20ma.

### 8 BRACKET COLOR<sup>1</sup>, PANEL SEAL (external foam gasket)

	X & XI w/Flush Bracket	X, XI, XII w/Raised Bracket
# of gaskets	0 1 2	0 1
Black	B C D	1 4
White	W Y Z	2 5
Gray	G H J	3 6

### 9 ACTUATOR

No Actuator	0
	Black Gray White Red
Contura X	1 2 3 4
Contura XI	6 7 8 9
Contura XII	J K N M

Actuator orientation above terminals: 3,6 1,4

### 3 RATING<sup>4</sup>

1	.4VA @ 28VDC Resistive
B	15A 24V
C	20A 18V
D	20A 12V
E	20A 14V, 10A 14VT (circuit 1, 4, A & D only)
F	10A 14V, 6A 14VT (circuit 6 only)
M	.4VA/20A 12V
N	.4VA/15A 24V

### 10 LENS - above lamp #1 terminals 1,4

### 11 LENS - above lamp #2 terminals 3,6

Lens color for LEDs must be clear, white, or match color of LED. Green or blue lenses are not recommended with Neon lamps.

0 - No Actuator	Z - No Lens
Clear	White Amber Green Red Blue
3 8	D J P V
4 9	E K R W
5 A	F L S Y
2 7	C H N U
1 6	B G M T

Lens Style: Bar, One piece Square, Two piece Square\* (w/ clear top protective lens), Two piece Square\* (w/ smoke top protective lens), Two piece Square\* (w/ white top protective lens)

\* All bottom lenses are molded of opaque material. Consult factory for other lens colors.

### 4 TERMINATION/BASE STYLE

8 term	10 term	Termination	Jumper
1	2	.250 TAB (QC) no barriers	No
A	B	.250 TAB (QC) with barriers	No
J	K	.250 TAB (QC) no barriers	Yes T2 to 5
3	4	Solder Lug no barriers	No
C	D	Solder Lug	No
5	6	Wire Leads no barriers	No
E	F	Wire Leads	No

Note: Use codes J & K for circuits H, G & M.

### 12 ACTUATOR LENS OR BODY LEGEND<sup>3</sup>

00 - No Legend this location/No actuator

11 ON	12 OFF	13 I	14 O
OFF	ON	O	I
15 O O	16 O O	17 O I	18 I O
F N	N F		
F	F		
21 OFF	22 ON	23 O	24 I
F	N		
25 O	26 O	27 O	28 I
F	N		

For additional legend options & codes, see pages 54-65 of this catalog

### 5 ILLUMINATION & SWITCH SEALING

Lamp #1: above terminals 1 & 4 end of switch.; Lamp #2: above terminals 3 & 6 end of switch.  
Positive (+) and negative (-) symbols apply to LED lamps only

Sealed	Unsealed	Lamps	Actuator Lens position when illuminated	Lamp wired to Terminals
S	0	None		
A	1	# 1	Independent	8+ 7-
B	2	# 1	Down	3+ 7-
C	3	# 2	Up	3+ 7-
D	4	# 1	Down	3+ 7-
		& # 2	Down	1+ 7-
E	5	# 1	Up	1+ 7-
		& # 2	Up	3+ 7-
F	6	# 1	Independent	8+ 7-
		& # 2	Up	3+ 6-
G	7	# 1	Independent	8+ 7-
		& # 2	Up	3+ 7-
H	Z	# 2	Independent	8+ 7-
U	Y	# 1	Independent	8+ 7-
		& # 2	Independent	10+ 9-
Selections for Single Pole Switches Only:				
J	8	# 1	Down	3+ 8-
		& # 2	Independent	6+ 7-
K	W	# 1	Independent	8+ 7-
		& # 2	Independent	6+ 7-
Selections for Double Pole Switches Only:				
L	9	# 1	Down	3+ 6-
M	R	# 2	Up	3+ 6-
N	T	# 1	Down	3+ 6-
		& # 2	Down	1+ 4-
P	V	# 1	Up	1+ 4-
		& # 2	Up	3+ 6-

### 13 LEGEND ORIENTATION<sup>3</sup>

0	No legend (used with codes 11-18 in selection 12)
1	Orientation 1
2	Orientation 2
3	Orientation 3
4	Orientation 4

### 14 ACTUATOR LENS LEGEND

00 No legend this location/no actuator (used with codes 11-18 in selection 12)

Selection 14 required when switch requires two legends. If the two legends consist of one lens & one body legend, lens legend must be specified in selection 12; body legend specified in selection 14. For legend options & codes, see pages 54-65 of this catalog.

NOTES  
Consult factory to verify horsepower rating for your particular circuit choice.

- Custom colors are available. Consult factory.
- White imprinting is standard on black actuators; Black imprinting is standard on white, red & gray actuators; Custom colors are available, consult factory.
- With 2 square lenses, use sel. 12 for lens above lamp 1, & selection 14 for lens above lamp 2.
- Additional ratings available. See page 21.
- Not available with Contura XI rockers.

**V 1 D A S W 0 1 - 1 P B 00 - 0**

1 Series    2 Circuit    3 Rating    4 Termination    5 Illumination    6 Lock    7 Lamp    8 Bracket    9 Actuator    10 Lens    11 Function    12 Legend    13 Legend Orientation

**1 SERIES**

**2 CIRCUIT**  
Terminal Connections as viewed from bottom of switch: ( ) - momentary

8 terminal	10 terminal	SP - single pole - uses terminals 1, 2 & 3.
8 - -7	8 - -7	DP - double pole uses terminals 1, 2, 3, 4, 5 & 6.
1 - -4	1 - -4	Terminals 7, 8, 9 & 10 for lamp circuit only.
2 - -5	2 - -5	
3 - -6	3 - -6	
	10 - -9	

**Position:**

SP	DP	2 & 3, 5 & 6	Connected Terminals	1 & 2, 4 & 5
1	A	ON	NONE	OFF
4	D	ON	NONE	ON
6	J	ON	OFF	ON
9	N	OFF	NONE	ON

**SPECIAL CIRCUITS**

H*	2 & 3	2 & 3, 5 & 4	5 & 4
G*	2 & 3, 5 & 6	2 & 3	OFF
S	2 & 3, 5 & 6	2 & 3	1 & 2
E*	5 & 6	5 & 3	5 & 1

\*Jumper between terminals 2 & 5 for circuits H, G, & M are specified in selection 4.  
External jumper between terminals 2 & 4 for circuit E are provided by customer. Circuit E may be used for SP OFF-ON-ON circuit.

**3 RATING\***

1 .4VA @ 28VDC Resistive  
 B 15A 24V  
 C 20A 18V  
 D 20A 12V  
 E 20A 14V, 10A 14VT (circuit 1, 4, A & D only)  
 F 10A 14V, 6A 14VT (circuit 6 only)  
 M .4VA/20A 12V  
 N .4VA/15A 24V

**4 TERMINATION/BASE STYLE**

8 term	10 term	Termination	Jumper
1	2	.250 TAB (QC) no barriers	No
A	B	.250 TAB (QC) with barriers	No
J	K	.250 TAB (QC) no barriers	Yes T2 to 5
3	4	Solder Lug no barriers	No
C	D	Solder Lug	No
5	6	Wire Leads no barriers	No
E	F	Wire Leads	No

Note: Codes J & K for circuits H, G & M.

**5 ILLUMINATION & SWITCH SEALING**  
Lamp above terminals 3 & 6 end of switch.  
Positive (+) and negative (-) symbols apply to LED lamps only

Sealed	Unsealed	Lamps	Actuator Lens position when illuminated	Lamp wired to Terminals
S	0	None		
C	3	# 2	Up	3+ 7-
H	Z	# 2	Independent	8+ 7-
M	R	# 2	Up	3+ 6-

Selections for Double Pole Switches Only:

**6 LOCK**  
Lock above terminals 1 & 4 end of switch.  
W lock

**7 LAMP**  
Lamp above terminals 3 & 6 end of switch.

No lamp	0				
Neon	1	125VAC	2 250VAC		
Incandescent	4	3V	5 6V	6 12V	7 18V 8 24V
LED*				superbright Green	superbright Red
2VDC	A	Red	Amber	F	R
6VDC	B	L	M	G	S
12VDC	C	N	H	T	
24VDC	D	P	J	V	

\* Consult factory for "daylight bright" LED options. Typical current draw for LED is 20ma.

**8 RAISED BRACKET COLOR', PANEL SEAL (external foam gasket)**

No Gasket	Black	White	Gray
One Gasket	1	2	3
	4	5	6

**9 HARD SURFACE ACTUATOR'**

Contura X	Black	Gray	White	Red
	1	2	3	4

Actuator orientation above terminals: 3,6 1,4

**10 LENS - above lamp #2 terminals 3,6**

Z - No Lens

Clear	White	Amber	Green	Red	Blue	Lens Style
3	8	D	J	P	V	Bar
4	9	E	K	R	W	One piece Square
5	A	F	L	S	Y	Two piece Square* (w/ clear top protective lens)
2	7	C	H	N	U	Two piece Square* (w/ smoke top protective lens)
1	6	B	G	M	T	Two piece Square* (w/ white top protective lens)

\* All bottom lenses are molded of opaque material. Consult factory for other lens colors.  
Lens color for LEDs must be clear, white, or match color of LED.  
Green or blue lenses are not recommended with Neon lamps.

**11 ACTUATOR LOCK FUNCTION AND COLOR\***

Lock Color	Up	Down	Up & Down
Match Actuator	A	H	R
Black	B	J	S
White	C	K	T
Red	D	L	V
Gray	E	M	W
Safety Orange	F	N	Y

**12 ACTUATOR, LENS OR BODY LEGENDS\***

00 - No Legend

21	22	23	24
OFF	ON	O	I
25	26	27	28
O	O	O	I
F	N		

For additional legend options & codes, see pages 54-65 of this catalog

**13 LEGEND ORIENTATION\***

0 No legend (used with codes 11-18 in selection 12)

1 Orientation 1  
 2 Orientation 2  
 3 Orientation 3  
 4 Orientation 4

NOTES  
 Consult factory to verify horsepower rating for your particular circuit choice.  
 1 Custom colors are available. Consult factory.  
 2 White imprinting is standard on black actuators; Black imprinting is standard on white, red and gray actuators; Custom colors are available, consult factory.  
 3 Located over T1-4 end of switch.  
 4 Additional ratings available. See page 21.



# V-Series Contura Sealed Rocker Switch Actuators Separately

Reduce inventory levels and cost by stocking actuators and base switches separately.

**Contura II, III, IV, V, X, XI, XII Base switches separately:** specify **V** with code selections 2-8 in the ordering schemes.

**Contura II, III, IV, V Actuator only:** **VV** with code **A** or **C** for selection 9, & with selections 10-14 in the ordering schemes.

**Panel Seal:** **VPS**

**Contura II, III, IV, V Actuator only:** **VV** with code **A, C, E, G** or **P** for selection 9 & with selections 10-14 in the ordering schemes.

**Contura X, XI, XII actuators with lenses separately:** **VV** with code selections 9-14 in the ordering schemes.

## Contura X & XI actuators without lenses separately:

**VVP 6 1 00 1**

1 Actuator Separately    2 Actuator Style/Color    3 Lens Opening    4 Actuator Legend    5 Legend Orientation

**1 CONTURA X & XI ACTUATOR SEPARATELY**  
**VVP**

**2 ACTUATOR STYLE & COLOR**

	Black	Gray	White	Red
Contura X	1	2	3	4
Contura XI	6	7	8	9

**3 LENS OPENING FOR<sup>1</sup>**

1	One bar lens	4	Two Square lens
2	One bar lenses	5	Square lens on top/ bar lens on bottom (Contura X only)
3	One Square lens		

**4 ACTUATOR LENS OR BODY LEGEND**

00 - No Legend this location

11	ON	12	OFF	13	I	14	O
	OFF		ON		O		I
15	O	16	O	17	O	18	I
	F		N		F		N
	F		F		F		F

For additional legend options & codes, see pages 54-65 of this catalog

**5 LEGEND ORIENTATION<sup>3</sup>**

0 No legend

1 Orientation 1

2 Orientation 2

3 Orientation 3

4 Orientation 4

## Contura X, XI & XII top piece of 2-piece lens separately:

**VVT 1**

1 Lens Separately    2 Color

**1 TOP OF LENS SEPARATELY**  
**VVT**

**2 COLOR**

1	Clear	2	Smoke	3	White
---	-------	---	-------	---	-------

## Contura X, XI & XII actuator lens assembly:

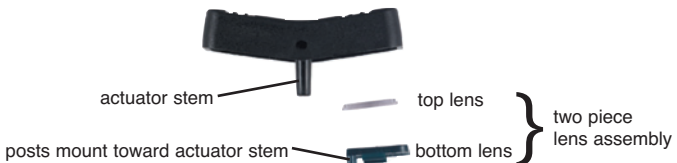

1 piece lens/bar lens are positioned the same as bottom lens for assembly, minus the top lens. Lenses snap in from bottom.

- NOTES**
- If actuator lens opening for 2 bar or 2 square lenses, legend orientation 0, 1, or 2 must be chosen.
  - Center of actuator marking not available for Contura XII.
  - Legend is not available for bar style lenses.
  - Not recommended with neon lamps.
  - Must also order top piece of 2 piece square lens separately.

## Contura XII actuators without lenses separately:

**VVP J 1 Z 21 1 00**

1 Actuator    2 Style & Color    3 Lens Opening    4 Lens Opening    5 Legend    6 Legend Orientation    7 Legend Orientation

**1 CONTURA XII ACTUATOR SEPARATELY**  
**VVP**

**2 ACTUATOR STYLE & COLOR**

J	Black	K	Gray	N	White	M	Red
---	-------	---	------	---	-------	---	-----

**3,4 LENS OPENING FOR**

Z	No lens	1	Bar lens	2	Square lens
---	---------	---	----------	---	-------------

**5, 7 LENS OR BODY LEGEND<sup>3</sup>**

00	no legend	21	OFF	22	ON	23	O	24	I
		25	O	26	O	27	O	28	I
			F		F		N		F

For additional legend options & codes, see pages 54-65 of this catalog.

**6 LEGEND ORIENTATION<sup>3</sup>**

0 No legend

1 Orientation 1

2 Orientation 2

## Contura X, XI & XII actuator lens assembly separately:

**VVL 2 1 00 0**

1 Lens Separately    2 Lens Style    3 Lens Color    4 Legend    5 Legend Orientation

**1 CONTURA X, XI & XII LENS SEPARATELY**  
**VVL**

**2 LENS STYLE<sup>3</sup>**

1	Bar lens	2	One Piece Square lens	3	Bottom of Two-Piece Square lens <sup>5</sup>
---	----------	---	-----------------------	---	--

**3 TRANSLUCENT LENS COLOR**

1	Clear	2	White	3	Amber	4	Green <sup>4</sup>	5	Red	6	Blue <sup>4</sup>
---	-------	---	-------	---	-------	---	--------------------	---	-----	---	-------------------

**4 LENS OR BODY LEGEND<sup>3</sup>**

00	No legend	21	OFF	22	ON	23	O	24	I
		25	O	26	O	27	O	28	I
			F		N		F		F

For additional legend options & codes, see pages 54-65 of this catalog

**5 LEGEND ORIENTATION<sup>3</sup>**

0 No legend

1 Orientation 1

2 Orientation 2

3 Orientation 3

4 Orientation 4

## Easily integrate Contura products into your system, with Contura Accessories

### Contura Connectors

Q.C. SELECTION GUIDE						
COMPANY SERIES	PART NO		WIRE RANGE		ORIENTATION	
	PLAIN BRASS	TIN PLATED BRASS	AWG	MM <sup>2</sup> (REF)		
PACKARD 58 SERIES	02965580		12	3.0	B	
	02965471	12010601	(2)16-14	(2)1.0-2.0		
	02965470		16-14	1.0-2.0		
	02965469	06288318	20-18	.5-.8		
PACKARD METRI-PACK 630 SERIES		12084590	10	5.0	A	
		12052224	12	3.0		
		12015870	16-14	1.0-2.0		
		12020035	(2)22-18	(2).5-.8		
		12015832	12015869	20-18		.5-.8
		12052222	20-22	.35-.5		
AMP 250 SERIES FASTIN-FASTON	60253-1	60253-2	16-12	1.3-3	B	
			(2) 16	(2) 1.3		
	42100-1	42100-2	18-14	.8-2		
	60295-1	60295-2	22-18	.3-.9		

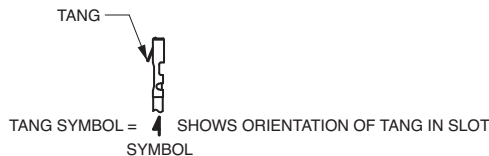
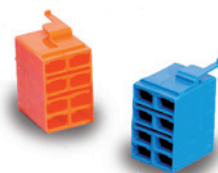

**NOTE:** Consult Delphi Packard and/or Amp on actual part numbers and availability.  
AMP is a registered trademark of AMP Inc. Harrisburg, PA  
Delphi Packard is a registered trademark of Delphi-Packard Electrical Systems Warren, Ohio

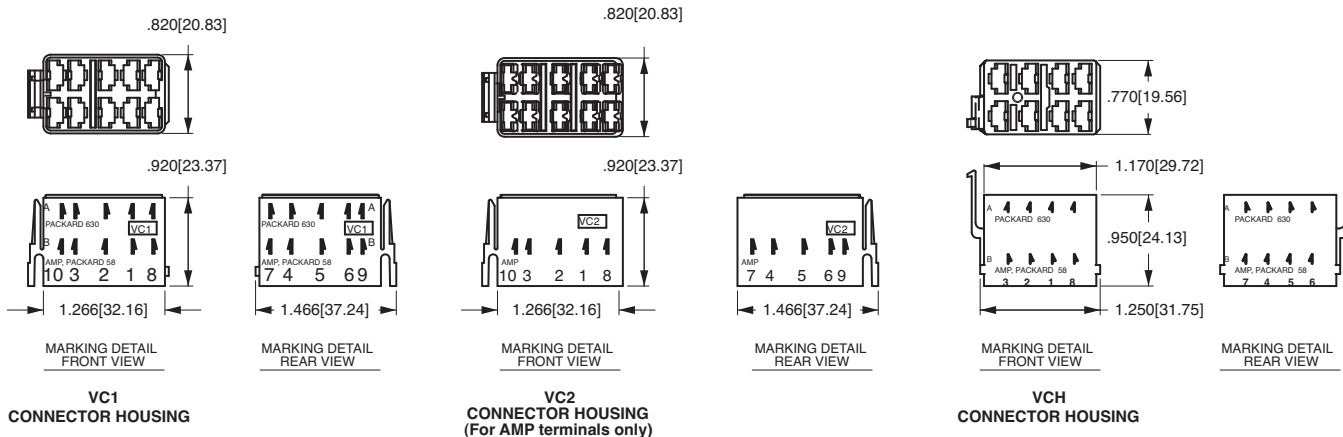

### Contura X Boot (P/N VB1-01)

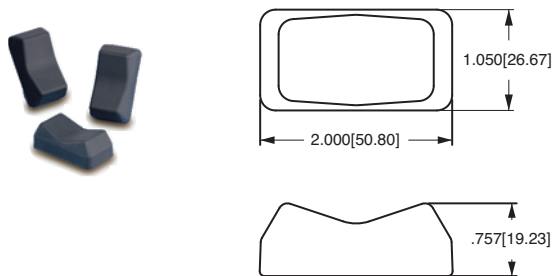

### Additional V-Series Ratings

- 1 .4VA @ 28VDC Resistive
- 4 10A 250VAC 1/2 HP, 15A 125 VAC 1/2 H, No Agency Listings
- 5 10A 250VAC 1/2 HP, 15A 125 VAC 1/2 HP, UL Recognized, CSA Certified
- 6\* 15A 125VAC 1/2 HP, 12(2)A 125 VAC  $\mu$  T85
- 7\* 15A 125VAC 1/2 HP, 12(6)A 125 VAC T85
- 8\* 10A 250VAC, 15A 125VAC, 1/2 HP 125-250VAC, 12(2)A 250 VAC  $\mu$  T85
- 9\* 10A 250VAC, 15A 125VAC, 1/2 HP 125-250VAC, 12(6)A 250 VAC T85
- B 15A 24V
- C 20A 18V
- D 20A 12V
- E 20A 14V, 10A 14VT (circuits 1, 4, A, & D only)
- F 10A 14V, 6A, 14VT (circuit G only)
- G 20A 6V
- H 20A 3V
- L 15A 125 VAC, 10A 250VAC, 1/2 HP 125-250 VAC; 6A 125 VAC L
- M .4VA/20A 12V (combi-contact)  
(combination gold/silver contacts for borderline dry circuit applications)
- N .4VA/15A 24V (combi-contact)  
(combination gold/silver contacts for borderline dry circuit applications)

### Contura II, III, IV & V Actuator Removal Tool (P/N VRT)

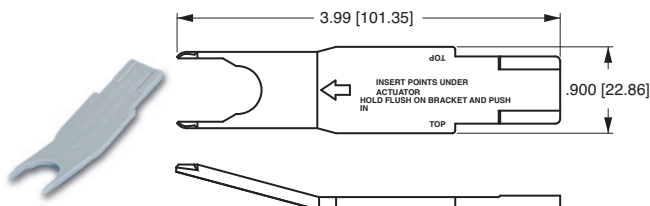

**NOTES**  
Consult factory to determine availability for individual circuits.  
\* Ratings 6 - 9 are UL, CSA, VDE, DEMKO, SEMKO, NEMKO, FIMKO & BEAB certified, require terminations A or B for double pole circuits, & are not available with illumination circuits 4, 8, D, J, N, & T or with wire lead or solder lug terminations. Circuits 1, 4, A & D are not available with rating 6 & 8. Rating 7 & 9 only available with circuits 1, 4, A & D. Circuits 2, 3, 5, 7, 8, K, L are 1/2 HP 250VAC only with rating 8. Ratings 6 & 7 must specify lamp code 1 (125VAC neon). Ratings 8 & 9 must specify lamp code 2 (250VAC neon). Rating L available with circuits 1, 4, A & D only.

## Contura Mounting Panels Dimensional Specifications: in. [mm]

**MOUNTING PANEL**  
For additional units, add 1.03[26.2] per unit.  
For more than 2 V-Series Switches, add middle section. Available in Panel Thicknesses listed below. Consult factory.

**MOUNTING PANEL THICKNESS**

.062[1.57]	.187[4.75]
.093[2.36]	.250[6.35]
.125[3.17]	.375[9.52]

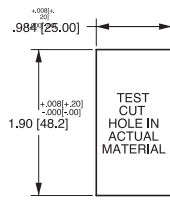

VMS MOUNTING PANEL HOLE

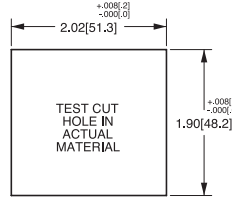

MOUNTING PANEL OPENING (2) UNITS

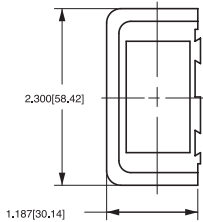
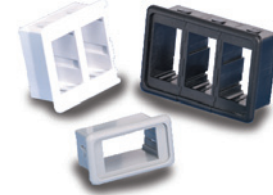

VME MOUNTING PANEL END

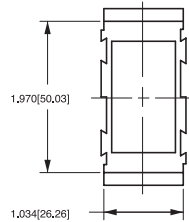

VMM MOUNTING PANEL MIDDLE

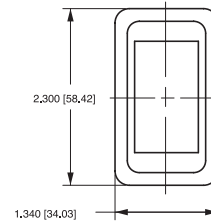

VMS MOUNTING PANEL

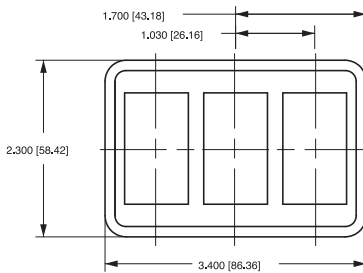

VM3 MOUNTING PANEL

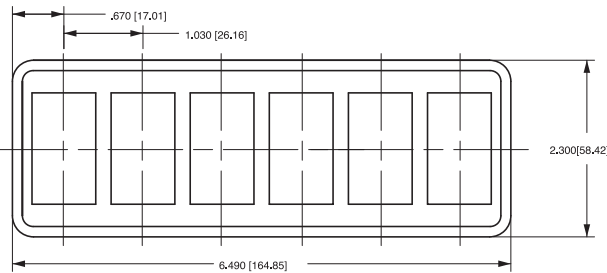

VM6 MOUNTING PANEL

## Contura Hole Plug Dimensional Specifications: in. [mm]

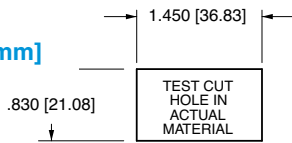

VHP MOUNTING PANEL PLUG

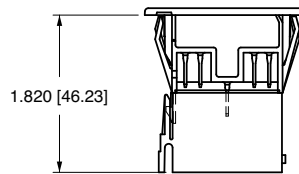
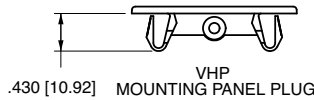
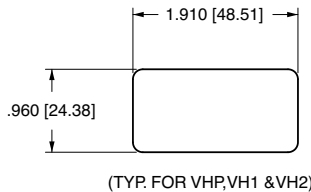

(No wing serrations)  
(With VC1 connector attached)

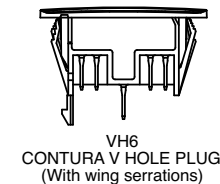
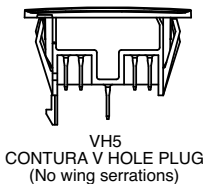
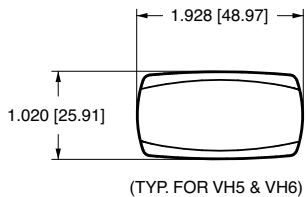
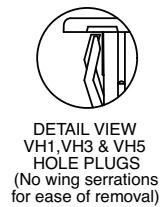
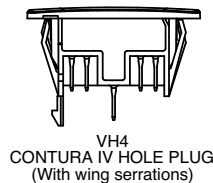
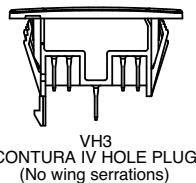
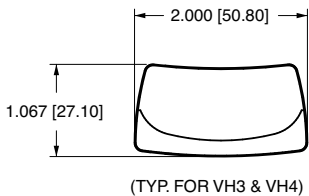
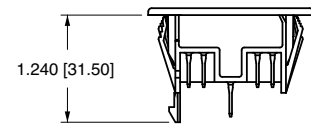

## VP-Series Contura Illuminated Indicator



The Illuminated Indicator is offered with removable/replaceable lamps, Contura styling, and LED illumination. As a critical safety feature, it's illumination alerts the operator of essential system functions or malfunctions like: oil pressure, high temperature, transmission or other fluid levels, parking brake, or general system malfunction. Three different style housings (flush, raised panel, oval) assure seamless integration with Contura switches and into most any dashboard panel.

**VP 1 6 6 - B 1 1 K K - 00 0 00**

1 Series    2 Termination    3 Lamp    4 Lamp    5 Housing Color    6 Lens Design    7 Lens Design    8 Lens Color    9 Lens Color    10 Legend    11 Legend Orientation    12 Actuator Legend

**1 SERIES**

<b>VP</b>	Illuminated plug housing only
<b>H2<sup>1</sup></b>	lamp module only
<b>H3<sup>2</sup></b>	VP connector for oval and flush bezel only
<b>VC1-01</b>	VP connector for raised bezel only

**2 TERMINATION**

<b>1</b>	.250 TAB
----------	----------

**3,4 LAMP (same coding for both selections)<sup>4,5,6,8,9,12</sup>**

Selection 6: above terminals 1 & 4; Selection 7: above terminals 3 & 6

No lamp	<b>0</b>				
Neon	<b>1</b> 125VAC	<b>2</b> 250VAC			
Incandescent	<b>4</b> 3V	<b>5</b> 6V	<b>6</b> 12V	<b>7</b> 18V	<b>8</b> 24V
LED <sup>*</sup>	<b>L</b> Amber	<b>F</b> Green	<b>R</b> Red		
2VDC	<b>M</b>	<b>G</b>	<b>S</b>		
6VDC	<b>N</b>	<b>H</b>	<b>T</b>		
12VDC	<b>P</b>	<b>J</b>	<b>V</b>		
24VDC					

\*Typical current draw for LED is 20ma.

**5 HOUSING COLOR**

	flush bracket	raised bracket <sup>13</sup>	oval bezel (Contura V)
Black	<b>B</b>	<b>6</b>	<b>1</b>
Gray	<b>W</b>	-	<b>2</b>
White	<b>R</b>	<b>5</b>	<b>3</b>
Red	<b>G</b>	-	<b>4</b>

**6,7 SQUARE LENS DESIGN (same coding for both selections)<sup>4,5,6,11,12</sup>**

<b>Z</b>	no lens	<b>3</b>	laser etched <sup>10</sup>
<b>1</b>	transparent diamond square <sup>10</sup>	<b>4</b>	transparent oval
<b>2</b>	translucent square <sup>7</sup>	<b>5</b>	translucent oval

**8, 9 LENS (same coding for both selections)<sup>3,4,5,6,9</sup>**

Lens color for LEDs must be clear, white, or match color of LED.

<b>Z</b>	No Lens					Lens Style
<b>4</b>	<b>9</b> White	<b>E</b> Amber	<b>K</b> Green	<b>R</b> Red	<b>W</b> Blue	<b>One piece Square/Oval<sup>11</sup></b>
<b>5</b>	<b>A</b>	<b>F</b>	<b>L</b>	<b>S</b>	<b>Y</b>	<b>Two piece Square*</b>
						(w/ clear top protective lens)
<b>2</b>	<b>7</b>	<b>C</b>	<b>H</b>	<b>N</b>	<b>U</b>	<b>Two piece Square*</b>
						(w/ smoke top protective lens)
<b>1</b>	<b>6</b>	<b>B</b>	<b>G</b>	<b>M</b>	<b>T</b>	<b>Two piece Square*</b>
						(w/ white top protective lens)

\* All bottom lenses are molded of opaque material. Consult factory for other lens colors.

**10 LAMP #1 LENS OR BODY LEGEND<sup>5</sup>**

<b>00</b>	No legend
-----------	-----------

For legend options & codes, see pages 54-65 of this catalog

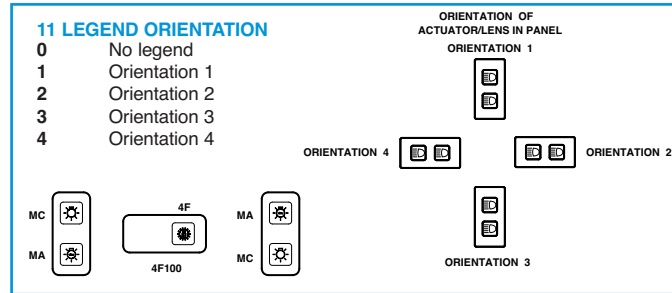

**12 LAMP #2 LENS OR BODY LEGEND<sup>5</sup>**

<b>00</b>	No legend
-----------	-----------

For legend options & codes, see pages 54-65 of this catalog

**NOTES**

- 1 To order housing with lenses only, specify H2 followed by fields 5-12. (flush bezel only)
- 2 To order lamp module only, specify H3 followed by fields 2-3. (flush bezel only)
- 3 Two piece lens not available with oval bezel.
- 4 If only 1 lamp, specify 0 in selection 4 and Z in selections 7 & 9.
- 5 Lamp and lens #1 located over terminals 1A and 1B for flush & oval bezel.
- 6 Lamp and lens #2 located over terminals 2A and 2B for flush & oval bezel.
- 7 Available with 2 piece lens option only.
- 8 Neon lamps not recommended with blue or green lenses.
- 9 Green or blue lenses not recommended with neon lamps.
- 10 Available with one piece lens option only.
- 11 Oval bezel available with oval lens only. Oval lens available with oval bezel only.
- 12 Lamp & lens #1 located over terminals 7 & 8, & #2 located over 9 & 10 for raised bezel option.
- 13 Both bracket and insert will be same color. For white bracket with black insert, specify 7. For black bracket with white insert, specify 8.



Dimensional Specifications: in. [mm]

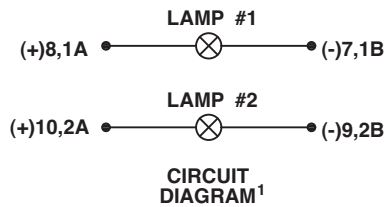
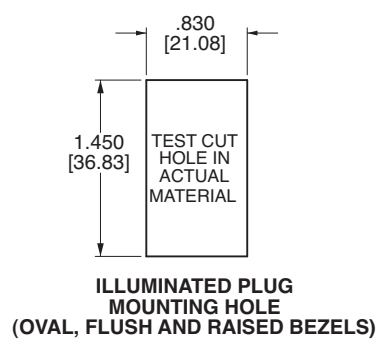
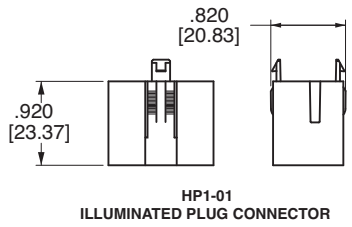
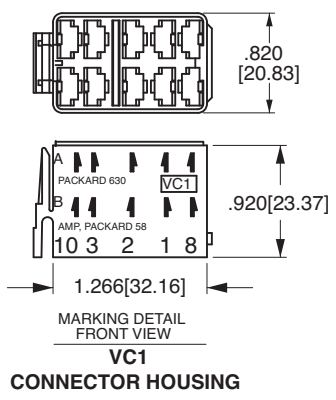
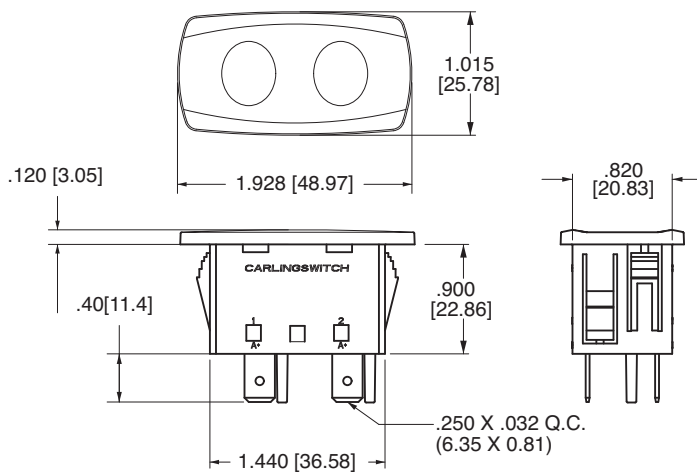
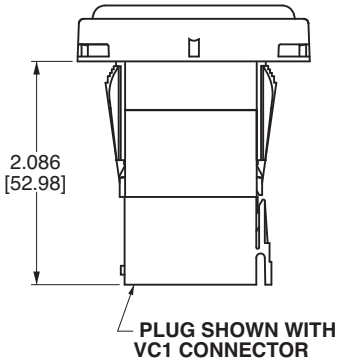
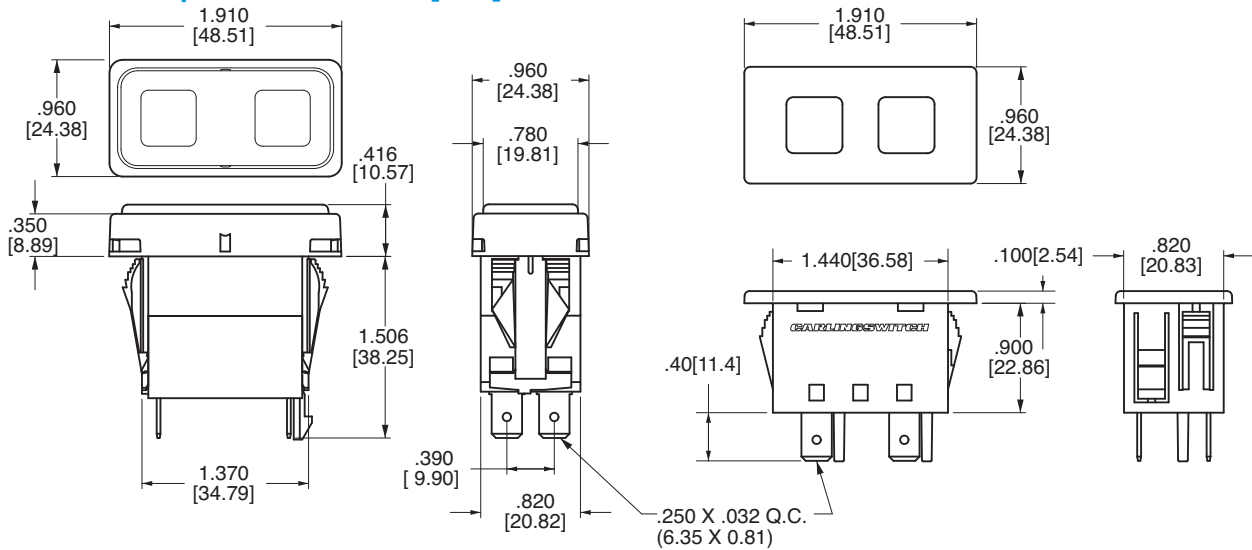

(OVAL, FLUSH AND RAISED BEZELS) MOUNTING PANEL THICKNESSES:

.062[1.57]	.250[6.35]
.093[2.36]	.375[9.52]
.125[3.17]	.500[12.70]
.187[4.75]	

NOTES  
1 Oval and flush bezel styles use terminals 1A, 1B, 2A, 2B. Raised bezel style uses terminals 7,8,9,10.



## Looking for a rugged, fully sealed rocker switch?

Carling Technologies set the standard for performance, reliability and aesthetics with the widely successful, often imitated, but never duplicated, V-Series rocker switches. Building further upon that platform, Carling has once again raised the bar with the fully sealed W-Series. The W-Series traditional appearance features complete IP68 protection, even below the panel, where the critical connection is made from your wiring harness. When used in conjunction with the integrated connector, the totally submersible W-Series provides a seal for up to ten individual wires, assuring compatibility with even the most complex circuitry.

The W-Series also offers a wide variety of accoutrements including endless illumination options featuring dual level and multicolor LEDs, progressive and hazard warning circuits, ratings up to 10A 24V, choice of paddle, rocker, locking or laser etched actuators, hundreds of standard legend choices and the electrical performance and reliability that is the hallmark of Carling Technologies products.

### Tri-Seal Design

Affords IP68 protection for the entire switch including terminals and connector

### Connector with Twin Locking Tabs

Provides sealed water tight connections as well as simple removal using only your hands.

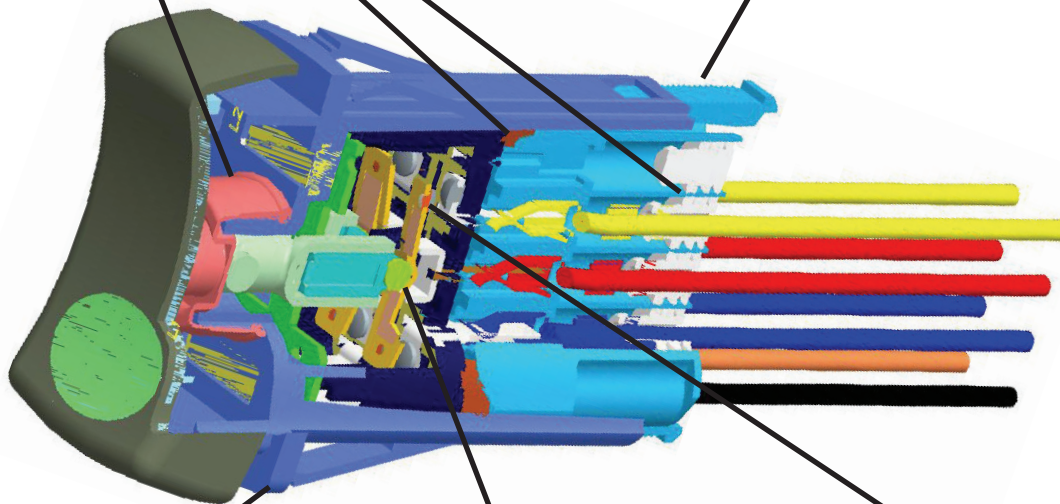

### An Easy Retrofit

W-Series fits industry standard mounting hole 1.450 x .830

### Functionality Under Extreme Conditions

Roller pin mechanism is lubricant free, withstanding temperatures from -40°C to +85°C.

### Proven Switch Mechanism

Butt-Action contacts are available in a wide variety of circuitry and platings to accommodate most any application.

# W-Series Fully Sealed Rocker Switches

## Electrical

Contact Rating . . . . .	.4VA @ 24VDC 10 amps, 3-24VDC
Dielectric Strength . . . . .	1500 Volts RMS
Insulation Resistance . . . . .	50 Megaohms
Initial Contact Resistance	10 milliohms max. @ 4 VDC
Life . . . . .	100,000 cycles
Contacts . . . . .	Silver tin-oxide, 88/12
Terminals . . . . .	Copper with silver or gold plating. Quick Connect terminations.
Voltage . . . . .	3-24 VDC
Overcurrent . . . . .	15A for 50 cycles

## Mechanical

Endurance . . . . .	250,000 cycles minimum
---------------------	------------------------

## Physical

Lighted . . . . .	LED - rated 100,000 hours 1/2 life (LED is internally ballasted for volt- ages to 24 VDC)
Seals . . . . .	Neoprene
Base . . . . .	Polyester blend rated to 125C with a UL flammability rating of 94V0.
Actuator . . . . .	Basic actuator structure molded of thermoplastic polycarbonate with a hard Nylon 66 thermoplastic surface overlay.
Lens . . . . .	Polycarbonate rated at 100°C
Function . . . . .	2 & 3 Position Rocker Style
Operation . . . . .	Maintained & Momentary
Base . . . . .	PA 6/6 30GF (glass filled)
Actuator . . . . .	PA 6/6 13GF
Bracket . . . . .	PBT 10GF
Connector . . . . .	PBT 10GF, polarized

## Environmental

Environmental . . . . .	IP68, Fully sealed
Corrosion/ Chemical Splash . . . . .	Flowing Mixed Gas (FMG) Class III 3 year accelerated expo- sure per ASTM B-827, B-845
Operating Temperature . . . . .	-40°C to +85°C, 22 cycles, 300 hours
Vibration 1 . . . . .	Per Mil-Std 202F, Method 204D Test Condition A 0.06 DA or 10G's 10-500 Hz.
Vibration 2 . . . . .	Resonance search 24-50 Hz 0.40 DA 50-2000 ±10 G's peak Results Horizontal Axis 3-5 G's max. Random 24 Hz                    0.06 PSD-Gsq/Hz 60 Hz                    0.50 100 Hz                    0.50 200 Hz                    0.025 2000 Hz                    0.025
Handling/Drop . . . . .	One meter onto concrete floor
Salt Spray . . . . .	Per Mil-Std 202F, Method 101D, Test Condition A, 48 Hrs.
Dust . . . . .	IP6X
Thermal Shock . . . . .	Per Mil-Std 202F, Method 107F, Test Condition A, -55°C to 85°C. Test cri- teria - pre and post test contact resistance
Moisture Resistance/ Humidity . . . . .	Per Mil-Std 202F, Method 106F, Test Criteria - pre and post test contact resistance

## Actuator Travel (Angular Displacement)

24° full throw

## Mounting Specifications

Panel Thickness Range .032 to .125

For optimum panel fit, the following panel thicknesses are suggested: .032, .062, .093, .125

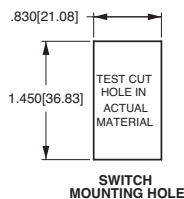

Dimensional Specifications: in. [mm]

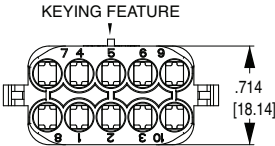
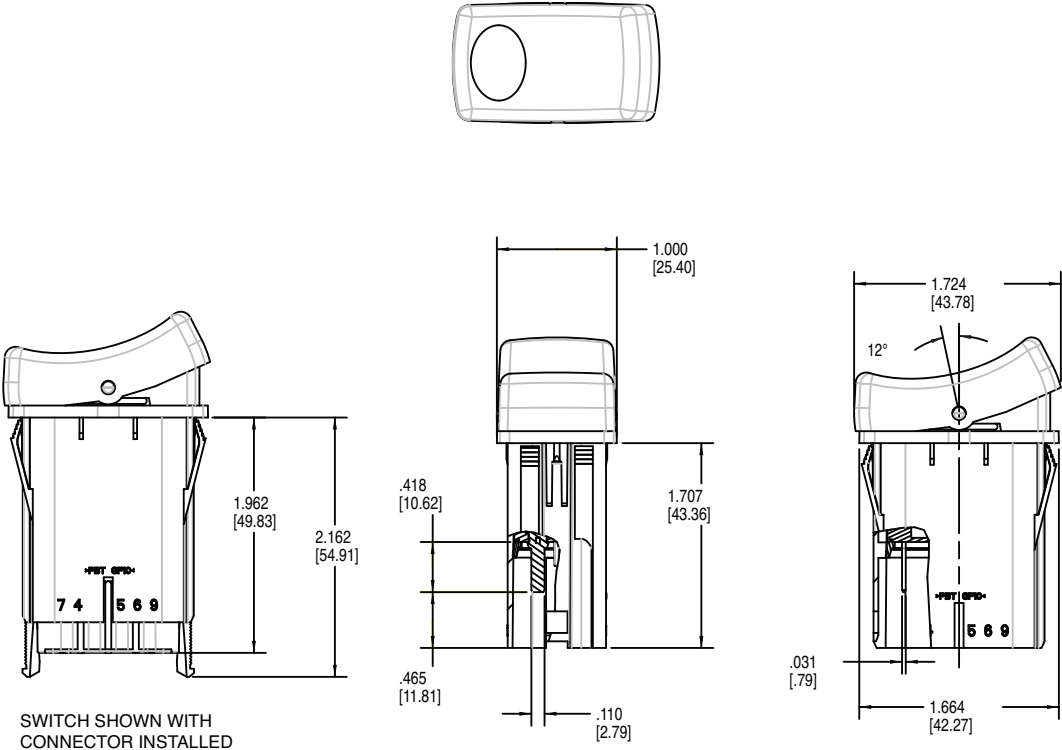

WCH CONNECTOR  
(190-31214-001)

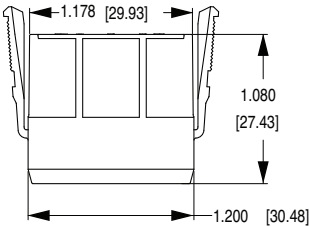

Notes:  
 WCH connector is intended for use with Tyco/Amp .110 Junior Power Timer, female contacts, and wire seals.  
 For 14-16 awg wire, specify Tyco/Amp P/N 927766-3  
 For 16-20 awg wire, specify Tyco/Amp P/N 927770-3  
 Tyco/Amp cable seal P/N 828904-1 (20-18 awg wire) or P/N 828905-1 (16-14 awg wire) is required for each individual wire lead, and Tyco/Amp cable plug, P/N 828922-1, is required to seal each unused connector opening. Consult Tyco/Amp for the cable seal recommended for your specific wire gauge and thickness.



<b>W</b>	<b>11</b>	<b>D</b>	<b>2</b>	<b>B</b>	<b>C</b>	<b>0</b>	<b>1</b>	<b>-</b>	<b>A</b>	<b>7</b>	<b>Z</b>	<b>00</b>	<b>-</b>	<b>0</b>	<b>00</b>
1 <i>Series</i>	2 <i>Circuit</i>	3 <i>Rating</i>	4 <i>Termination</i>	5 <i>Illumination</i>	6 <i>Lamp</i>	7 <i>Lamp</i>	8 <i>Bracket</i>		9 <i>Actuator</i>	10 <i>Lens</i>	11 <i>Lens</i>	12 <i>Legend</i>		13 <i>Legend Orientation</i>	14 <i>Actuator Lens Legend</i>

### 1 SERIES W

#### 2 CIRCUIT

Terminal Connections as viewed ( ) - momentary  
from bottom of switch:

8 terminal	10 terminal		
8 - 7	8 - 7		
1 - 4	1 - 4		
2 - 5	2 - 5		
3 - 6	3 - 6		
	10 - 9		

SP - single pole - uses terminals 1, 2 & 3.  
DP - double pole uses terminals 1, 2, 3, 4, 5 & 6.  
Terminals 7, 8, 9 & 10 for lamp circuit only.

<b>Position:</b>		<b>1</b>	<b>2</b>	<b>3</b>
SP	DP	2 & 3, 5 & 6	Connected Terminals	1 & 2, 4 & 5
11	21	ON	NONE	OFF
12	22	(ON)	NONE	OFF
13	23	ON	NONE	(OFF)
14	24	ON	NONE	ON
15	25	ON	NONE	(ON)
16	26	ON	OFF	ON
17	27	ON	OFF	(ON)
18	28	(ON)	OFF	(ON)
-	49	ON	ON	ON

#### 3 RATING

<b>B</b>	10A 24V
<b>D</b>	10A 12V
<b>G</b>	10A 6V
<b>H</b>	10A 3V

#### 4 TERMINATION/BASE STYLE

<b>2</b>	.110 TAB (QC)
----------	---------------

#### 5 ILLUMINATION & SWITCH SEALING

Lamp #1: above terminals 1 & 4 end of switch.; Lamp #2 above terminals 3 & 6 end of switch.  
Positive (+) and negative (-) symbols apply to LED lamps only

Code	Lamps	Actuator Lens position when Illuminated	Lamp wired to Terminals
<b>0</b>	None		
<b>A</b>	# 1	Independent	8+ 7-
<b>B</b>	# 1	Down	3+ 7-
<b>C</b>	# 2	Up	3+ 7-
<b>D</b>	# 1	Down	3+ 7-
	&# 2	Down	1+ 7-
<b>E</b>	# 1	Up	1+ 7-
	&# 2	Up	3+ 7-
<b>F</b>	# 1	Independent	8+ 7-
	&# 2	Up	3+ 6-
<b>G</b>	# 1	Independent	8+ 7-
	&# 2	Up	3+ 7-
<b>H</b>	# 2	Independent	8+ 7-
Selections for Single Pole Switches Only:			
<b>J</b>	# 1	Down	3+ 8-
	&# 2	Independent	6+ 7-
<b>K</b>	# 1	Independent	8+ 7-
	&# 2	Independent	6+ 7-
Selections for Double Pole Switches Only:			
<b>L</b>	# 1	Down	3+ 6-
<b>M</b>	# 2	Up	3+ 6-
<b>N</b>	# 1	Down	3+ 6-
	&# 2	Down	1+ 4-
<b>P</b>	# 1	Up	1+ 4-
	&# 2	Up	3+ 6-
<b>R</b>	# 1	Down	3+ 7-
	&# 2	Up	6+ 7-
<b>S</b>	# 1	Down	6+ 7-
	&# 2	Independent	8+ 7-
<b>U</b>	# 1	Independent	8+ 7-
	&# 2	Independent	10+ 9-
<b>V</b>	# 2	Independent	10+ 9-
<b>W</b>	# 1	Independent	8+ 7-
	&# 2	Independent	10+ 7-
<b>Y</b>	# 1 & 2	Independent in Series	8+ 7-
<b>Z</b>	# 1 & 2	Independent in Parallel	8+ 7-

#### 6,7 LAMP (same coding for both selections)

Selection 6: above terminals 1 & 4; Selection 7: above terminals 3 & 6

No lamp **0**

LED\*

	Red	Amber	superbright Green	White
2VDC	<b>A</b>	<b>L</b>	<b>F</b>	<b>4</b>
6VDC	<b>B</b>	<b>M</b>	<b>G</b>	<b>5</b>
12VDC	<b>C</b>	<b>N</b>	<b>H</b>	<b>6</b>
24VDC	<b>D</b>	<b>P</b>	<b>J</b>	<b>8</b>

\* Consult factory for "daylight bright" LED options. Typical current draw for LED is 20ma.

#### 8 BRACKET COLOR<sup>1</sup>

<b>1</b>	Black
----------	-------

#### 9 ACTUATOR<sup>1,3</sup>

<b>3</b>	Black with Laser Etch
<b>A</b>	Black

#### 10 LENS - above lamp #1 terminals 1,4 11 LENS - above lamp #2 terminals 3,6

Lens color for LEDs must be clear, white, or match color of LED.

<b>0</b>	No Actuator	<b>Z</b>	No Lens
Clear	White	Amber	Green
<b>1</b>	-	<b>B</b>	<b>G</b>
-	<b>7</b>	<b>C</b>	<b>H</b>
<b>3</b>	-	<b>D</b>	<b>J</b>
-	<b>9</b>	<b>E</b>	<b>K</b>
<b>5</b>	<b>A</b>	-	-
		Red	Blue
		<b>M</b>	<b>T</b>
		<b>N</b>	<b>U</b>
		<b>P</b>	<b>V</b>
		<b>R</b>	<b>W</b>
		-	-

Lens Style  
**Transparent Large**  
**Translucent Large**  
**Transparent Bar**  
**Translucent Bar**  
**Laser Etch**  
 (Background Color)

#### 12 ACTUATOR LENS OR BODY LEGEND<sup>2</sup>

**00** - No Legend this location/No actuator

<b>11</b>	ON	<b>12</b>	OFF	<b>13</b>	I	<b>14</b>	O
	OFF		ON		O		I
<b>15</b>	O	<b>16</b>	O	<b>17</b>	O	<b>18</b>	I
	F		N		F		I
<b>21</b>		<b>22</b>		<b>23</b>		<b>24</b>	
	OFF		ON		O		I
<b>25</b>	O	<b>26</b>	O	<b>27</b>	O	<b>28</b>	I
	F		N		F		I

For additional legend options & codes, see pages 54-65 of this catalog

#### 13 LEGEND ORIENTATION

<b>0</b>	No legend (used with codes 11-18 in selection 12)
<b>1</b>	Orientation 1
<b>2</b>	Orientation 2
<b>3</b>	Orientation 3
<b>4</b>	Orientation 4

#### 14 ACTUATOR LENS LEGEND<sup>2</sup>

**00** No legend this location/no actuator (used with codes 11-18 in selection 12)

Selection 14 required when switch requires two legends. If the two legends consist of one lens & one body legend, lens legend must be specified in selection 12; body legend specified in selection 14. For legend options & codes, see pages 54-65 of this catalog.

NOTES  
 1 Custom colors are available. Consult factory.  
 2 White imprinting is standard on black actuators; Black imprinting is standard on white, red & gray actuators; Custom colors are available, consult factory.  
 3 Locking rocker version is also available, consult factory for details.

L-Series Sealed Rocker Switches

Making the right connections has never been easier — with the L-Series Rocker Switch from Carling Technologies. Not only does this innovative switch offer total design flexibility, it has set new standards for both performance and reliability. It's IP67 certified, and able to withstand temperatures from -40°C to +85°C. Features include countless switch and lamp circuit combinations, LED illuminated lenses or laser etched rockers, as well as hundreds of legend choices and several accessories.



**Eliminates need for retooling**

Neatly proportioned, our L-Series fits into industry standard mounting holes of 1.734" x .867" and 44.0mm x 22.0mm.

**Withstands extreme temperatures**

Roller pin mechanism eliminates need for lubricants, so it can withstand from -40°C to +85°C.

**Integrates easily into your system**

You can choose from a variety of termination options, including .250 TAB QC & .187 TAB QC.

**Ensures greater shock protection**

Welded lamp connection and one-piece internal, jumperless terminal withstand extreme shock and vibration.

**Maximizes your design flexibility**

Twelve terminals offer you an extensive range of switch and lamp circuit options, including LED or incandescent illumination.

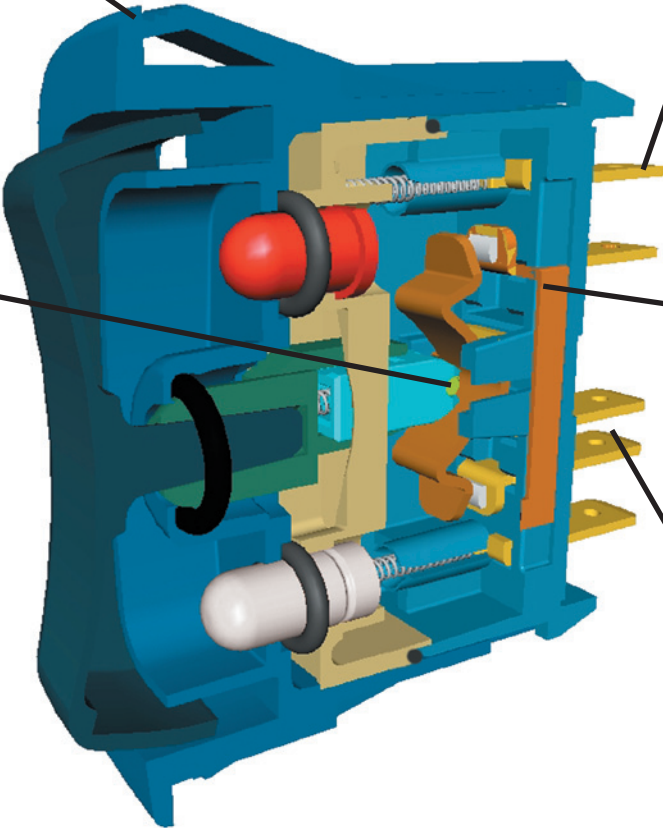

## Electrical

Contact Rating . . . . .	.4VA @ 24VDC (MAX) resistive 15 amps, 125VAC 10 amps, 250VAC 20 amps, 4-14VDC 15 amps, 15-28VDC
Dielectric Strength . . . . .	1250 Volts RMS between pole to pole 3750 Volts RMS between live parts and accessible surfaces
Insulation Resistance . . .	50 Megaohms
Initial Contact Resistance.	10 milliohms max. @ 4VDC
Life . . . . .	100,000 cycles maintained, 50,000 cycles momentary at rated voltage and current
Contacts . . . . .	90/10 silver-nickel, silver tin-oxide, gold
Terminals . . . . .	Brass or copper/silver plate 3/16" (4.76mm) & 1/4" (6.3mm) Quick Connect terminations standard.

## Mechanical

Endurance . . . . .	250,000 cycles minimum
---------------------	------------------------

## Physical

Lighted . . . . .	Incandescent - rated 10,000 hours LED - rated 100,000 hours 1/2 life (LED is internally ballasted for voltages to 24 VDC)
Seals . . . . .	Rocker, base & bracket are sealed.
Base . . . . .	Nylon 66 GF rated to 85°C with a flammability rating of 94V0.
Rocker . . . . .	Nylon 66 Reinforced, rated to 105°C (modular lens). Locking rocker, standard rocker & paddle. Laser etching with a polycarbonate actuator.
Lock . . . . .	Acetal
Lens . . . . .	Polycarbonate rated at 100°C.
Bracket . . . . .	Nylon Zytel
Connector . . . . .	Nylon 66 rated at 85°C. Polarized.

## Actuator Travel (Angular Displacement)

2 position . . . . .	26°
3 positions . . . . .	13° from center

## Environmental

Environmental . . . . .	IP67 for above panel components of the actual switch, representing an index of protection as applied to electrical equipment in accordance with IEC 529, BS 5490, DIN 400 50 & NFC 20 010.
Corrosion Resistance . . .	Mixed Flowing Gas MFG Class III per ASTM B-827 & B-845, Method H, with 3 years exposure.
Operating Temperature . . .	-40°C to + 85°C
Vibration 1 . . . . .	Per Mil-Std 202F, Method 204D Test Condition A 0.06 DA or 10G's 10-500 Hz. Tested with VCH connector. Test criteria - No loss of circuit during test and pre and post test contact resistance.
Vibration 2 . . . . .	Resonance search 24-50 Hz 0.40 DA 50-2000 ±10 G's peak Results Horizontal Axis 3-5 G's max. Random 24 Hz                   0.06 PSD-Gsq/Hz 60 Hz                   0.50 100 Hz                  0.50 200 Hz                  0.025 2000 Hz                0.025 No loss of circuit during test; <10µ chatter.
Shock . . . . .	Per Mil-Std 202F, Method 213B, Test Condition K @ 30G's. Tested with VCH connector. Test criteria - No loss of circuit during test, pre, and post test contact resistance.
Salt Spray . . . . .	Per Mil-Std 202F, Method 101D, Test Condition A, 48 Hrs.
Thermal Shock . . . . .	Per Mil-Std 202F, Method 107F, Test Condition A, -55°C to 85°C. Test criteria - pre and post test contact resistance.
Moisture Resistance . . . .	Per Mil-Std 202F, Method 106F, Test Criteria - pre and post test contact resistance.

## Mounting Specifications

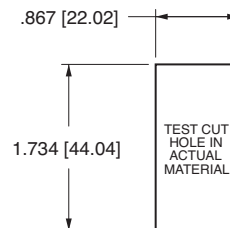

MOUNTING HOLE

**Panel Thickness Range**  
 Acceptable Panel Thickness  
 .030 to .156 (.76mm to 3.96mm)  
 Recommended:  
 .030, .062, .093, .125 and .156

Dimensional Specifications: in. [mm]

**L-SERIES**  
SHOWN WITH LASER ETCHED  
ACTUATOR

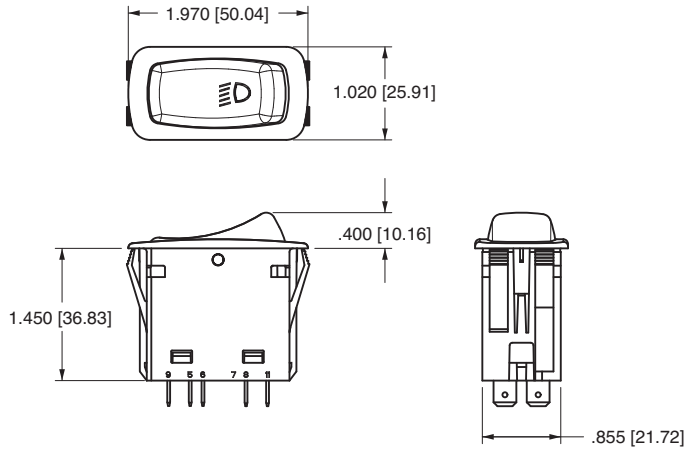

**L-SERIES**  
SHOWN WITH ROCKER GUARD

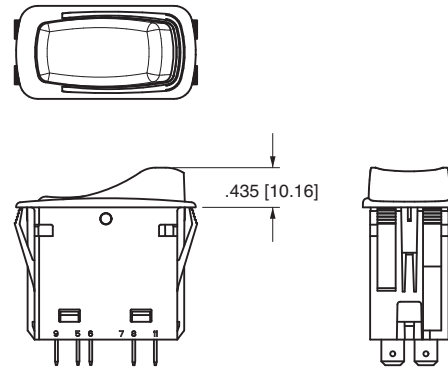

**L-SERIES**  
SHOWN WITH LARGE LENS  
AND PADDLE ACTUATOR

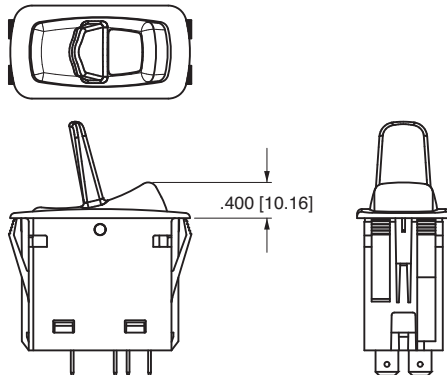

**L-SERIES**  
SHOWN WITH BAR LENS, LOCK  
AND CONNECTOR

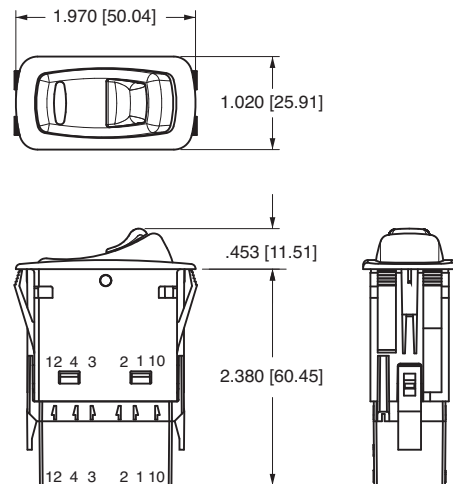

Connector

**L-SERIES**  
CONNECTOR

- LC1-01** BLACK .250 TAB CONNECTOR (PACKARD 630 SERIES)
- LC2-01** BLACK .187 TAB CONNECTOR (PACKARD 480 SERIES)
- LC3-01** BLACK .250 TAB CONNECTOR (AMP ONLY)

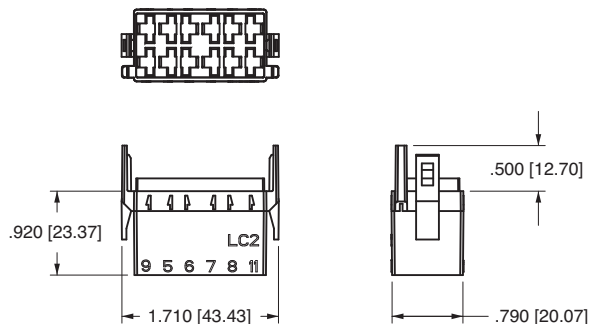

Hole Plug

**L-SERIES**  
HOLE PLUG

- LH1** REMOVABLE HOLE PLUG WITH NON-SERRATED WINGS
- LH2** HOLE PLUG WITH SERRATED WINGS

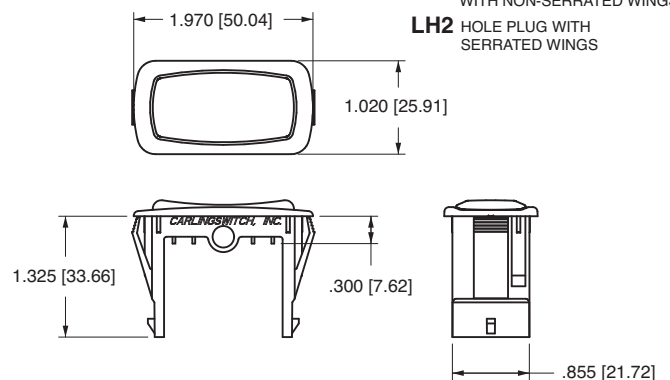



## Mounting Panel Dimensional Specifications: in. [mm]

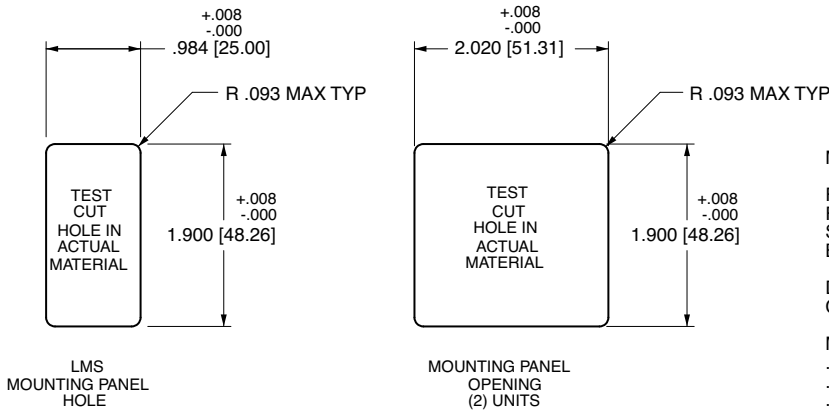

### MOUNTING PANEL

FOR ADDITIONAL UNITS, ADD 1.03 [26.2] PER UNIT. FOR MORE THAN 2 L-SERIES SWITCHES, ADD MIDDLE SECTION. AVAILABLE IN PANEL THICKNESSES LISTED BELOW. CONSULT FACTORY

DIMENSIONS: LME 2.02 [51.3mm] PLUS NUMBER OF CENTER BEZELS (LMM) X 1.034 [26.26mm]

### MOUNTING PANEL THICKNESS

- .062 [1.57]
- .093 [2.36]
- .125 [3.17]
- .156 [3.96]

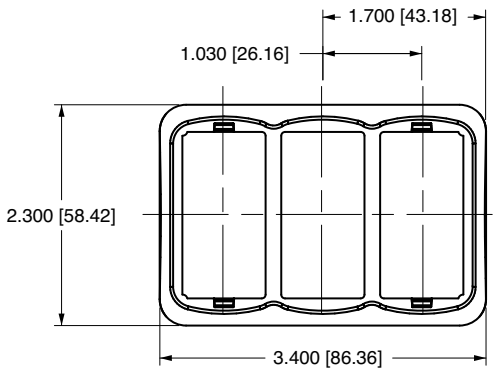
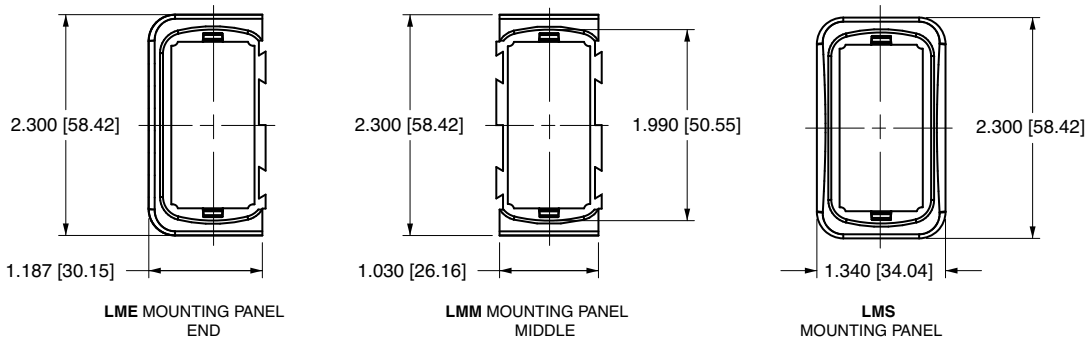

PANEL OPENING SIZE: 1.90 X 3.06 [48.3mm X 77.7mm]

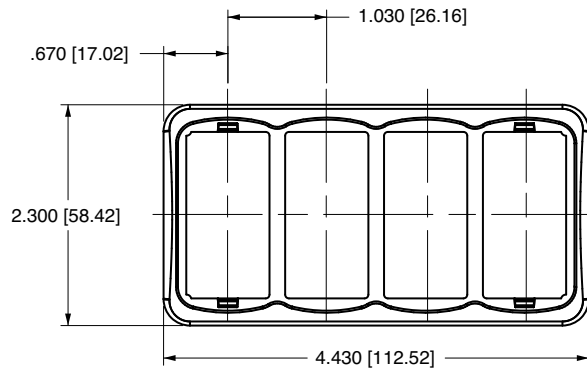

PANEL OPENING SIZE: 1.90 X 4.09 [48.3mm X 103.9mm]

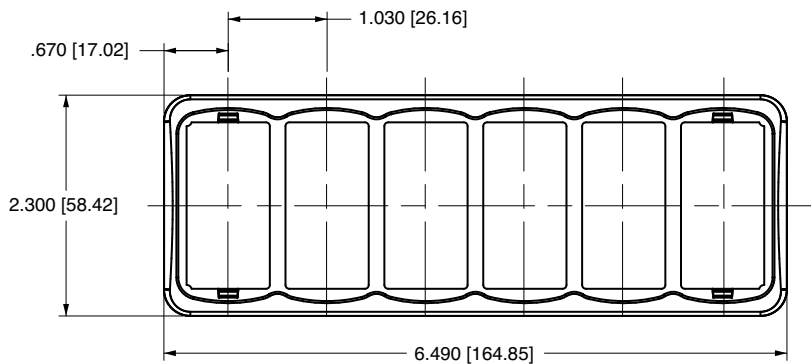

PANEL OPENING SIZE: 1.90 X 6.15 [48.3mm X 156.2mm]

CIRCUIT CODE	SCHEMATIC	CIRCUIT CODE	SCHEMATIC	CIRCUIT CODE	SCHEMATIC
11		22		51	
12		23		52	
13		24		53	
14		25		54	
15		26		55	
16		27		56	
17		28		57	
18		30		58	
21		31		61	

# L-Series Switch Circuit Diagrams

CIRCUIT CODE	SCHEMATIC	CIRCUIT CODE	SCHEMATIC
62		71	
63		72	
64		73	
65		80	
66		81	
67		82	
68		A2	
69		A3	
70			

ILLUMIN. CODE	SCHEMATIC
A	
B	
C	
D	
E	
F	
G	
H	

ILLUMIN. CODE	SCHEMATIC
J	
1	
2	

LEGEND	
SYMBOL	DEFINITION
	TERMINAL LOCATION
	LAMP LOCATION
	MAINTAINED CIRCUIT
	MOMENTARY CIRCUIT
	INTERNAL CONNECTION (JUMPER TERMINAL)
	2 POSITION CONNECTION
	2 POSITION
	3 POSITION



# L-Series Sealed Rocker Switches

<b>L</b>	<b>11</b>	<b>E</b>	<b>3</b>	<b>C</b>	<b>H</b>	<b>N</b>	<b>1</b>	<b>-</b>	<b>3</b>	<b>A</b>	<b>A</b>	<b>45</b>	<b>-</b>	<b>1</b>	<b>48</b>
1 Series	2 Circuit	3 Rating	4 Termination	5 Illumination	6 Lamp	7 Lamp	8 Bracket	9 Actuator	10 Lens Style & Color	11 Lens Style & Color	12 Legend	13 Legend Orientation	14 Actuator Lens Legend		

### 1 SERIES

**L**

---

### 2 CIRCUIT<sup>2</sup>

**Terminal Orientation**

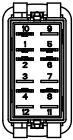

( ) - momentary

SP - single pole - uses terminals 1, 2 & 4.  
DP - double pole uses terminals 5, 6 & 8.  
Terminals 9, 10, 11 & 12 for lamp circuit only.

Position: 1	2	3
SP DP 2 & 4, 6 & 8	Connected Terminals	1 & 2, 5 & 6
11 21 ON	NONE	OFF
12 22 (ON)	NONE	OFF
13 23 ON	NONE	(OFF)
14 24 ON	NONE	ON
15 25 ON	NONE	(ON)
16 26 ON	OFF	ON
17 27 ON	OFF	(ON)
18 28 (ON)	OFF	(ON)

**CIRCUITS WITH JUMPER TERMINALS**

30* (2,4&5),(1,6&8)	OFF, OFF	(1,2&8),(4,5&6)
31 1,2&5	2,3&7	2,4&8

**PROGRESSIVE CIRCUITS**

51 3&4	2&3	1&2
52 3&4	2&3	OFF
53 (3&4)	2&3	1&2
54 (3&4)	2&3	OFF
55 (3&4)	2&3	(1&2)
56 (3&4)	2&3	(OFF)
57 3&4	2&3	(OFF)
58* 2&4	2&3	1&2
61 3&4,7&8	2&3,6&7	1&2,5&6
62 3&4,7&8	2&3,6&7	OFF, OFF
63 (3&4),(7&8)	2&3,6&7	1&2,5&6
64 (3&4),(7&8)	2&3,6&7	OFF, OFF
65 (3&4),(7&8)	2&3,6&7	(1&2),(5&6)
66 (3&4),(7&8)	2&3,6&7	(OFF),(OFF)
67 3&4,7&8	2&3,6&7	(OFF),(OFF)
68 2&4,7&8	2&4, OFF	OFF, OFF
69* 2&4,1,7&8	2&4, OFF	OFF, OFF
70 (2&4),(7&8)	2&4,5&7	(1&2),(5&7)
71 (2&4),(7&8)	2&4,5&7	1&2,5&7
72 2&4,7&8	2&4,5&7	1&2,5&7
73 (2&4),(7&8)	2&4, OFF	OFF, OFF
80 2&4,6&8	2&4, OFF	OFF,5&6

**HAZARD WARNING CIRCUITS**

A2 6,7&8, 3&4	NONE	OFF,1&2
A3 6,7&8, 2&4	NONE	OFF,1&2

\* Available with ratings 1, 4, & E only.

### 3 RATING<sup>2</sup>

1 .4VA @ 28VDC Resistive	D 20A 12V
4 10A 250VAC 1/2 HP,	E 15A 12V
15A 125VAC 1/2 HP, No Listings	G 20A 6V
B 15A 24V	H 20A 3V
C 20A 18V	

### 4 TERMINATION<sup>2,3,4</sup>

1 .250 (6.4mm) TAB (QC)	3 .187 (4.7mm) TAB (QC)
-------------------------	-------------------------

**NOTES:**  
Consult factory to verify horsepower rating for your particular circuit choice.

- 1 Custom colors are available. Consult factory.
- 2 Circuits 30, 31, 58, 69 when used in combination with termination codes 1, B, and E. are not available with rating codes 4, C, D, G or H.
- 3 Termination 3 only available with rating codes 1, B, and E.
- 4 Termination 1 not available with rating code 4.
- 5 Not available with circuits 11-18, 51-57 and 69.

### 5 ILLUMINATION

Lamp #1: above terminals 9 & 10 end of switch.; Lamp #2 above terminals 11 & 12 end of switch. Positive (+) and negative (-) symbols apply to LED lamps only.

Lamps	Illumination Type	Lamp wired to Terminals		
S None				
A # 1	Independent	10+	9-	
B # 2	Independent	12+	11-	
C # 1	Independent	10+	9-	
&# 2	Independent	12+	9-	
D # 1	Dependent	4+	9-	
E # 1	Independent	10+	9-	
&# 2	Dependent	4+	9-	
F # 1	Independent	10+	9-	
&# 2	Dependent	8+	9-	
G # 1	Dependent	4+	9-	
&# 2	Independent	10+	9-	
H # 1	Both Independent	10+	9-	
&# 2	(in series)			
J # 1	Dependent	4+	9-	
&# 2	Dependent	1+	9-	
1 # 2	Hazard	6+	10+	12-
2 # 1	Hazard	6+	10+	12-

### 6,7 LAMP (same coding for both selections)

Selection 6: above terminals 10 & 9; Selection 7: above terminals 12 & 11

No lamp **0**

Incandescent	4 3V	5 6V	6 12V	7 18V	8 24V
LED*	Red	Amber	Green		
2VDC	<b>A</b>	<b>L</b>	<b>F</b>		
6VDC	<b>B</b>	<b>M</b>	<b>G</b>		
12VDC	<b>C</b>	<b>N</b>	<b>H</b>		
24VDC	<b>D</b>	<b>P</b>	<b>J</b>		

\* Consult factory for "daylight bright", blue/green and white LED options.  
Typical current draw for LED is 20ma.

### 8 BRACKET COLOR<sup>1</sup>

	Black	White	Gray	Red
Standard Bracket	<b>1</b>	<b>2</b>	<b>3</b>	<b>4</b>
Rockerguard at Lamp 1	<b>A</b>	<b>F</b>	<b>G</b>	<b>D</b>
Rockerguard at Lamp 2	<b>E</b>	<b>H</b>	<b>C</b>	<b>H</b>

### 9 ACTUATOR STYLE AND COLOR<sup>1</sup>

	Black	White	Gray	Red	Laser Etched
Rocker	<b>A</b>	<b>B</b>	<b>C</b>	<b>D</b>	<b>3</b>
Paddle	<b>J</b>	<b>N</b>	<b>K</b>	<b>M</b>	<b>4</b>

### 10 & 11 LENS STYLE AND COLOR

Lens color for LEDs must be clear, white, or match color of LED.

0 - No Actuator	Z - No Lens				
Clear	White	Amber	Green	Red	
1	-	<b>B</b>	<b>G</b>	<b>M</b>	<b>T</b> Large Transparent
-	<b>7</b>	<b>C</b>	<b>H</b>	<b>N</b>	<b>U</b> Large Translucent
3	-	<b>D</b>	<b>J</b>	<b>P</b>	<b>V</b> Bar Transparent
-	<b>9</b>	<b>E</b>	<b>K</b>	<b>R</b>	<b>W</b> Bar Translucent
5	<b>A</b>	-	-	-	Laser Etch background color

### 12 LASER ETCH, LENS OR BODY LEGEND

**00** No legend this location / no actuator  
For legend options & codes, see pages 54-65 of this catalog.

### 13 LEGEND ORIENTATION

**0** No legend (used with codes 11-18 in selection 12)

**1** Orientation 1 - vertical, lamp 1 on top

**2** Orientation 2 - horizontal, lamp 1 on right

**3** Orientation 3 - vertical, lamp 1 on bottom

**4** Orientation 4 - vertical, lamp 1 on left

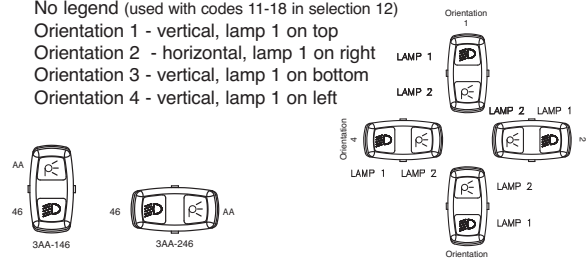

### 14 ACTUATOR LENS LEGEND

**00** No legend this location / no actuator  
For legend options & codes, see pages 54-65 of this catalog.

**L 11 D 1 S W C J - P M H 00 - 0**

1 Series    2 Circuit    3 Rating    4 Termination    5 Illumination    6 Lock    7 Lamp    8 Bracket    9 Actuator    10 Lens    11 Lock    12 Legend    13 Legend Orientation

**1 SERIES**  
**L**

**2 CIRCUIT<sup>2</sup>**  
**Terminal Orientation**

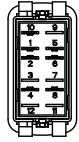

( ) - momentary  
 SP - single pole - uses terminals 1, 2 & 4.  
 DP - double pole uses terminals 5, 6 & 8.  
 Terminals 9, 10, 11 & 12 for lamp circuit only.

Position:	1	2	3 (lock location)
SP	DP	2 & 4, 6 & 8	Connected Terminals
11	21	ON	NONE
14	24	ON	NONE
16	26	ON	OFF
17	27	ON	OFF
18	28	(ON)	OFF

**CIRCUITS WITH JUMPER TERMINALS**

30 <sup>2</sup>	(2,4&5),(1,6&8)	OFF, OFF	(1,2&8),(4,5&6)
31 <sup>2</sup>	1,2&5	2,3&7	2,4&8

**PROGRESSIVE CIRCUITS**

51	3&4	2&3	1&2
52	3&4	2&3	OFF
53	(3&4)	2&3	1&2
54	(3&4)	2&3	OFF
55	(3&4)	2&3	(1&2)
56	(3&4)	2&3	(OFF)
57	3&4	2&3	(OFF)
58	2&4	2&3	1&2
61	3&4,7&8	2&3,6&7	1&2,5&6
62	3&4,7&8	2&3,6&7	OFF, OFF
63	(3&4),(7&8)	2&3,6&7	1&2,5&6
64	(3&4),(7&8)	2&3,6&7	OFF,OFF
65	(3&4),(7&8)	2&3,6&7	(1&2),(5&6)
66	(3&4),(7&8)	2&3,6&7	(OFF),(OFF)
67	3&4,7&8	2&3,6&7	(OFF),(OFF)
68	2&4,7&8	2&4,OFF	OFF,OFF
69	2&4,1,7&8	2&4,OFF	OFF,OFF
70	(2&4),(7&8)	2&4,5&7	(1&2),(5&7)
71	(2&4),(7&8)	2&4,5&7	1&2,5&7
72	2&4,7&8	2&4,5&7	1&2,5&7
73	(2&4),(7&8)	2&4,OFF	OFF,OFF
80	2&4,6&8	2&4,OFF	OFF,5&6

**3 RATING<sup>5</sup>**

1	.4VA @ 28VDC Resistive	D	20A 12V
4	10A 250VAC 1/2 HP, 15A 125VAC 1/2 HP, No Listings	E	15A 12V
B	15A 24V	G	20A 6V
C	20A 18V	H	20A 3V

**4 TERMINATION<sup>4,5</sup>**

1	.250 (6.4mm) TAB (QC)	3	.187 (4.7mm) TAB (QC)
---	-----------------------	---	-----------------------

**5 ILLUMINATION<sup>2</sup>**  
 Lamp located above terminals 11 & 12, position 1 end of switch.  
 Positive (+) and negative (-) symbols apply to LED lamps only.

Lamps	Illumination Type	Lamp wired to Terminals
S	None	
B	# 2 Independent	12+ 11-

**6 LOCK**  
**W** Lock above terminals 10 & 9.

**7 LAMP**

Above terminals 12 & 11

No lamp	0				
Incandescent	4 3V	5 6V	6 12V	7 18V	8 24V
LED*	Red	Amber	Green		
2VDC	A	L	F		
6VDC	B	M	G		
12VDC	C	N	H		
24VDC	D	P	J		

\* Consult factory for "daylight bright", blue/green and white LED options.  
 Typical current draw for LED is 20ma.

**8 BRACKET COLOR<sup>1</sup>**  
 Black J

**9 ACTUATOR STYLE AND COLOR<sup>1</sup>**

Locking Rocker	Black P	Red R
----------------	---------	-------

**10 LENS STYLE AND COLOR**  
 Lens color for LEDs must be clear, white, or match color of LED.

0 - No Actuator	1	3	9	Z - No Lens	White	Amber	Green	Red	Blue
Clear	-	7	-	B	C	D	E	G	H
White	-	7	-	B	C	D	E	G	H
Amber	-	7	-	B	C	D	E	G	H
Green	-	7	-	B	C	D	E	G	H
Red	-	7	-	B	C	D	E	G	H
Blue	-	7	-	B	C	D	E	G	H
Large Transparent	-	7	-	B	C	D	E	G	H
Large Translucent	-	7	-	B	C	D	E	G	H
Bar Transparent	-	7	-	B	C	D	E	G	H
Bar Translucent	-	7	-	B	C	D	E	G	H

**11 LOCK FUNCTION AND COLOR**

Locking Position	Up	Down	Up & Down	Center <sup>3</sup>	Lock Color
A	H	R	S	1	Match Actuator
B	J	S	T	2	black
C	K	T	V	3	white
D	L	V	W	4	red
E	M	W		5	safety orange

**12 LENS OR BODY LEGEND**  
**00** No legend this location / no actuator  
 For legend options & codes, see pages 54-65 of this catalog.

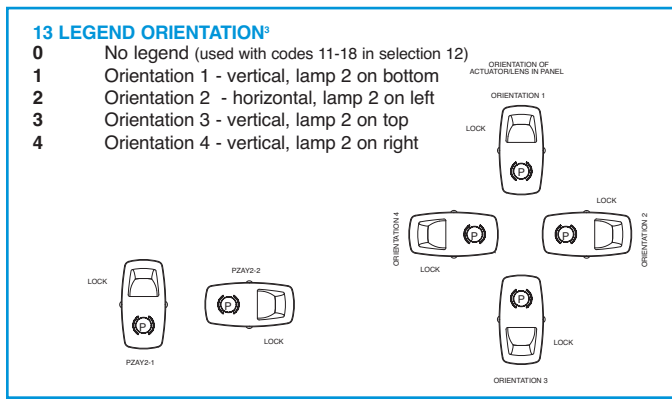

NOTES:  
 Consult factory to verify horsepower rating for your particular circuit choice.

- 1 Custom colors are available. Consult factory.
- 2 Additional lamp circuits available. Consult factory.
- 3 Available only with 3 position circuits.
- 4 Termination 1 not available with rating 4.
- 5 Termination 3 only available with ratings 1, B and E.
- 6 Circuits 30, 31, 58 and 69, when used in combination with termination codes 1 is not available with rating codes 4, C, D, G or H.



The LP-Series Illuminated Indicators are the perfect complement to the aesthetics, reliability and performance of our L-Series rocker switches. As a critical safety feature, the illumination alerts the operator of essential system functions or malfunctions, such as: Oil Pressure, High Temperature, Transmission or other fluid levels, Parking Brake or General System confirmations. The L-Series styling assures seamless integration into most any dashboard panel to meet the needs of today's Off Highway, Heavy Vehicle, Marine, Appliance and Industrial Control markets.

**Dimensional Specifications in. [mm.]:**

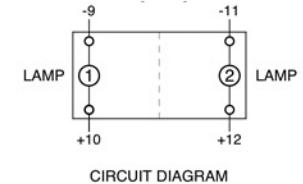
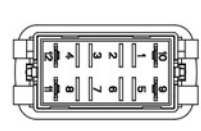
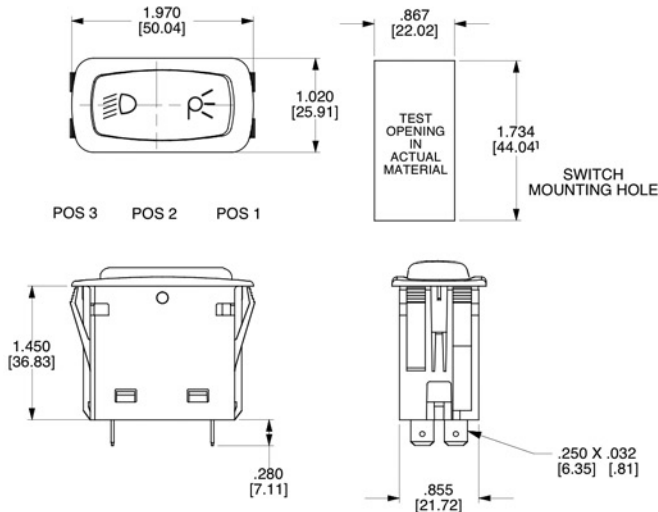

**General Specifications:**

**Electrical**

Terminals . . . . . Brass or copper/silver plate  
 3/16" (4.76mm) & 1/4" (6.3mm)  
 Quick Connect terminations standard.  
 Lighted . . . . . Incandescent - rated 10,000 hours  
 LED - rated 100,000 hours 1/2 life  
 (LED is internally ballasted for voltages to 24VDC)

**Physical**

Seals . . . . . Insert, base & bracket are sealed.  
 Base . . . . . Nylon 66 GF rated to 85°C with a flammability rating of 94VO.  
 Insert . . . . . Polycarbonate rated at 100°C.  
 Connector . . . . . Nylon 66 rated at 85°C. Polarized  
 Markings . . . . . Over 1000 pad printed or laser etched legends available  
 Bracket. . . . . Nylon 66 GF rated to 85°C

**Environmental**

Environmental . . . . . IP67, representing an index of protection as applied to electrical equipment in accordance with IEC 529, BS 5490, DIN 400 50 & NFC 20 010.  
 Corrosion Resistance . . . . . Mixed Flowing Gas MFG Class III per ASTM B-827 & B-845, Method H, with 3 years exposure.  
 Operating Temperature . . . . . -40°C to +85°C

Vibration 1 . . . . . Per Mil-Std 202F, Method 204D Test Condition A 0.06 DA or 10G's 10-500 Hz. Tested with VCH connector. Test criteria - No loss of circuit during test and pre and post test contact resistance.  
 Vibration 2 . . . . . Resonance search  
 24-50 Hz 0.40 DA  
 50-2000 ±10 G's peak  
 Results Horizontal Axis 3-5 G's max.  
 Random  
 24 Hz 0.06 PSD-Gsq/Hz  
 60 Hz 0.50  
 100 Hz 0.50  
 200 Hz 0.025  
 2000 Hz 0.025  
 No loss of circuit during test; <10µ chatter.  
 Shock . . . . . Per Mil-Std 202F, Method 213B, Test Condition K @ 30G's. Tested with VCH connector. Test criteria - No loss of circuit during test, pre, and post test contact resistance.  
 Salt Spray . . . . . Per Mil-Std 202F, Method 101D, Test Condition A, 48 Hrs.  
 Thermal Shock . . . . . Per Mil-Std 202F, Method 107F, Test Condition A, -55°C to 85°C. Test criteria - pre and post test contact resistance.  
 Moisture Resistance . . . . . Per Mil-Std 202F, Method 106F, Test Criteria - pre and post test contact resistance.

**LP 1 H R R 5 - 9 A A - Y2 1 DU**

1 Series    2 Termination    3 Illumination    4 Lamp    5 Lamp    6 Bracket Color    7 Insert Color    8 Style    9 Style    10 Legend 1    11 Legend Orientation    12 Legend 2

**1 SERIES**  
**LP** L-Series Illuminated plug

**2 TERMINATION<sup>1</sup>**  
**1** .250 (8.35) x .032 (0.51) Quick Connect  
**2** .187 (4.75) x .032 (0.51) Quick Connect

**3 ILLUMINATION**

LAMPS	ILLUMINATION	LAMP WIRED TO TERMINALS
<b>A</b> 1	—	10 (+) 8 (-)
<b>B</b> 1	—	10 (+) 8 (-)
<b>2</b>	—	12 (+) 11 (-)
<b>C</b> 1	—	10 (+) 8 (-)
<b>2</b>	—	12 (+) 8 (-)
<b>E</b> 1 & 2	Parallel	10 (+) 8 (-)
<b>H</b> 1 & 2	Series	10 (+) 8 (-)

LAMP 1 LOCATED ABOVE TERMINALS 9 & 10 END OF BRACKET.  
 LAMP 2 LOCATED ABOVE TERMINALS 11 & 12 END OF BRACKET.  
 POSITIVE (+) AND NEGATIVE (-) SYMBOLS APPLY TO LED LAMPS ONLY.

**4,5 LAMP (same coding for both selections)<sup>2</sup>**

Selection 4: specifies lamp 1 located above terminals 10 (+) & 9 (-).  
 Selection 5: specifies lamp 2 located above terminals 12 (+) & 11 (-).

No lamp	0 (position 5 only)	4 3V	5 6V	6 12V	7 18V	8 24V
Incandescent	L	M	N	P	T	H
LED	A	B	C	D	E	F
2VDC	L	M	N	P	T	H
6VDC	A	B	C	D	E	F
12VDC	L	M	N	P	T	H
24VDC	A	B	C	D	E	F

**6 BRACKET COLOR**  
 Black    **5**

**7 INSERT COLOR<sup>1,2</sup>**  
**9** Painted Black - Laser Etch  
**A** Clear (Transparent)  
**B** White (Translucent)  
**C** Red (Translucent)  
**D** Amber (Translucent)  
**E** Green (Translucent)  
**F** Blue (Translucent)

**8, 9 STYLE (same coding for both selections)**  
**Z** Not Painted (used with INSERT COLORS A-F)  
**5** Clear Laser Etch Background Color (used with INSERT COLOR 9)  
**A** White Laser Etch Background Color (used with INSERT COLOR 9)

**10 LEGEND OVER LAMP<sup>1</sup>**  
**00** No legend  
 — Laser Etched or Body Legends  
 For legend options & codes, see pages 54-65 of this catalog.

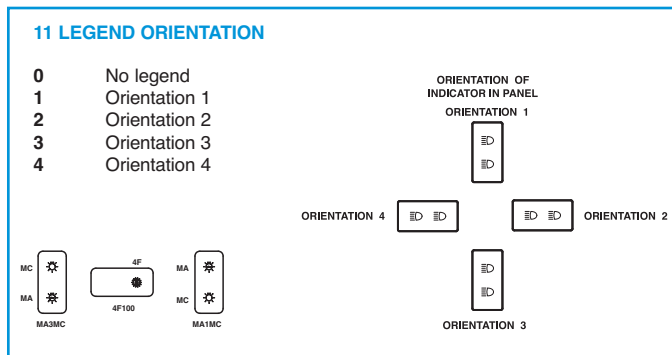

**12 LEGEND OVER LAMP<sup>2</sup>**  
**00** No legend  
 — Laser Etched or Body Legends  
 For legend options & codes, see pages 54-65 of this catalog.

NOTES  
 1 To order separately, specify LPC and selection 7 code. Ex LPC-9  
 2 For LEDs, insert color must be clear, white or match color of LED.  
 3 For connector, specify part number LC2-01 (.187 tabs), LC3-01 (.250 tabs).



S-Series Rocker Switches



The S-Series rocker switches are designed for use in the enclosed cabs of today's trucks, with special focus afforded to the vehicle operator. With features including abbreviated travel 1/2 throw actuators, ergonomic rockers, illumination in up to three detent switch positions, and a non-teasable snap action circuit, these switches provide the driver with easily recognizable and simple to operate controls. Designers will appreciate the 10A, 24VDC rating, space saving compact envelope, clean bezel-less design, integrated low insertion force connector and polarized switch base for quick installation. Most any illumination and switch circuitry is easily accommodated with the S-Series 10 terminal base. These great features, combined with over 1000 available laser etched or padprinted legends, allow the S-Series to be seamlessly incorporated into just about any cab interior environment.

General Specifications:

**Electrical**

Contact Rating . . . . . 10A @ 24VDC  
 Dielectric Strength . . . . . 1500 Volts RMS between pole to pole  
 Insulation Resistance . . . . . 50 Megaohms  
 Initial Contact Resistance. 10 milliohms max. @ 4VDC  
 Life . . . . . 100,000 cycles maintained circuit, 50,000 cycles momentary circuit at rated voltage and current  
 Contact Material. . . . . Silver tin-oxide  
 Terminals . . . . . .110 Tabs, Silver Plated Brass  
 Operating Temperature. . . -40°C to +85°C  
 Circuitry . . . . . SP, DP 2 & 3 position, 1/2 or full throw  
 Contact Bounce . . . . . <20 milliseconds

**Mechanical**

Endurance . . . . . 250,000 cycles minimum

**Physical**

Lighted . . . . . LED - rated 100,000 hours 1/2 life (LED is internally ballasted for voltages to 24VDC.)  
 Bracket. . . . . Acetal  
 Base . . . . . Nylon 66 GF  
 Rocker . . . . . Polycarbonate  
 Weight . . . . . 25 gms max.

**Connector**

Amp/Tyco MCP 2.8 receptacle housing P/N 1418994-1 mates with Amp/Tyco MCP 2.8 flat type receptacle. Based on wire size, choose P/N below:

- 1-968880-1 . . . . . 20-24 awg wire
- 1-968849-1 . . . . . 17-20 awg wire
- 1-968851-1 . . . . . 13.5-17 awg wire

**Environmental**

2 position (1/2 throw). . . . . 12°  
 3 position (full throw) . . . . 12° from center

**Environmental**

Operating Temperature . . -40°C to +85°C  
 Vibration . . . . . Per IEC 68-2.6 test Fc and 68-2.47 Test Criteria - no noise or contact chatter below 10ms.  
 Cold Test . . . . . Per IEC 68-2-1 -40°C for 72 hours Test Criteria - pre & post test contact resistance.  
 Dry Heat Test Criteria . . . Per IEC 68-2-2 + 85°C for 72 hours Test Criteria - no loss of circuit during test, pre & post test contact resistance.  
 Handling Shock . . . . . Drop from height of 1 meter, 3 times, 4 sides. Test criteria - No loss of circuit during test, pre & post test contact resistance.  
 Thermal Shock . . . . . Per IEC 68-2-14, -40°C to +85°C. Test criteria - pre & post test contact resistance.

**Mounting Specifications**

Snap in Mount . . . . . 40mm x 20mm keyed hole (see dimensional specifications for details.)

Dimensional Specifications in. [mm.]:

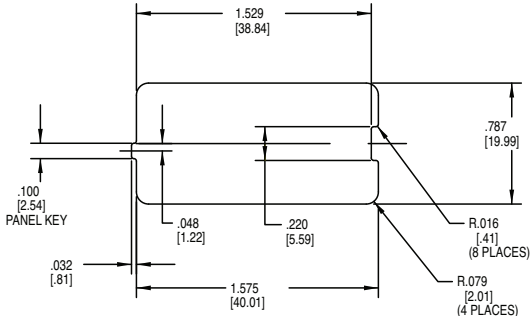
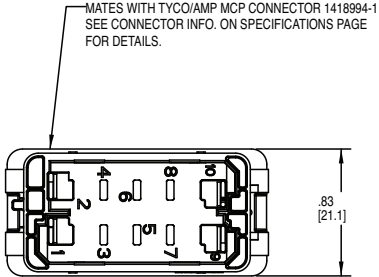

PANEL THICKNESS: 2.5±0.1mm  
PANEL OPENING CLEARANCE: ±5°  
SCALE 2.000

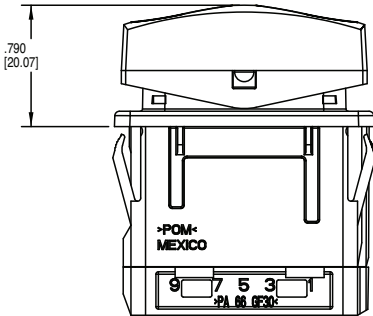
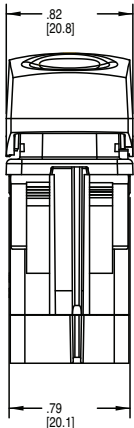
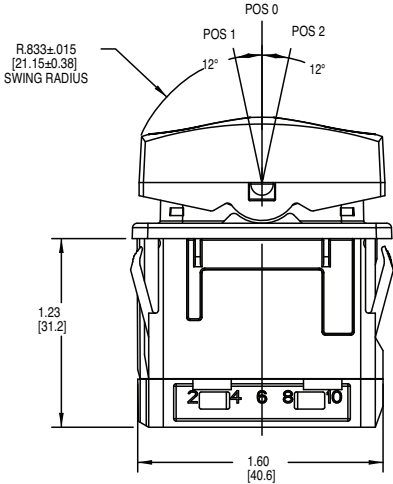

**S 18 A A R F 0 4 - 4 2 1 Z 00 - 1 00 00**

1 Series    2 Circuit    3 Rating    4 Illumination    5 Lamp 1    6 Lamp 2    7 Lamp 3    8 Bracket Color    9 Actuator Color    10 Legend Color 1    11 Legend Color 2    12 Legend Color 3    13 Legend 1    14 Legend Orientation    15 Legend 2    16 Legend 3

**1 SERIES**  
**S** S-Series

**2 CIRCUIT**

Terminal Connections as viewed from bottom of switch:    ( ) - momentary

1 - 2    SP - single pole uses terminals 3, 5 & 7.  
 3 - 4    DP - double pole uses terminals 3, 5, 7 & 4, 6, 8.  
 5 - 6  
 7 - 8  
 9 - 10

**Position:**

	1	2	3
SP	5 & 7, 6 & 8	Connected Terminals	3 & 5, 4 & 6
16	26 ON	OFF	ON
18	28 (ON)	OFF	(ON)
<b>SPECIAL CIRCUITS</b>			
31	(6 & 8)	4, 5, 6, 7	OFF
41	51 ON	OFF	NONE <sup>1</sup>
42	52 (ON)	OFF	NONE <sup>1</sup>
43	53 (ON)	3 & 5	NONE <sup>1</sup>
44	54 ON	3 & 5	NONE <sup>1</sup>
45	55 (ON)	OFF	ON
46	56 NONE	5 & 7	ON
47	57 NONE	5 & 7	(ON)
	75 (5 & 7, 3 & 6)	5 & 7, 4 & 6	(3 & 5, 4 & 6)
	98 <sup>2</sup> (5 & 7, 2 & 6)	5 & 7, 4 & 6	(5 & 9, 4 & 6)

**3 RATING**

**1** 0.4VA 28VDC Resistive  
**A<sup>3</sup>** 10.5mA 1.5A 28VDC, 5A 28V 50A Inrush Lamp Load  
**B<sup>4</sup>** 3.5A 28VDC, 18A Inrush  
**C<sup>3</sup>** 10mA 10A 28VDC

**4 ILLUMINATION**

LAMPS	ILLUMINATION	LAMP WIRED TO TERMINALS
<b>S</b> NONE	INDEPENDENT	-
<b>A</b> 1	INDEPENDENT	1 (+) 2 (-)
<b>C</b> 1	INDEPENDENT	1 (+) 2 (-)
<b>D</b> 1	INDEPENDENT	9 (+) 2 (-)
<b>D</b> 2	INDEPENDENT	1 (+) 2 (-)
<b>E</b> 1 & 3	INDEPENDENT	9 (+) 10 (-)
<b>F</b> 1	INDEPENDENT	1 (+) 2 (-)
<b>G</b> 1 & 2	INDEPENDENT	1 (+) 10 (-)
<b>H</b> 1 & 2	DEPENDENT	9 (+) 2 (-)
<b>J</b> 1, 2 & 3	INDEPENDENT	1 (+) 2 (-)
<b>J</b> 1, 2 & 3	DEPENDENT	9 (+) 10 (-)
<b>K</b> 1 & 2	INDEPENDENT	1 (+) 2 (-)
<b>K</b> 1 & 2	INDEPENDENT	9 (+) 10 (-)

3.3K RESISTOR IN PARALLEL

**5,6,7 LAMP (same coding for all 3 selections)**  
 Selection 5: specifies lamp 1 located above terminals 1 (+) & 2 (-).  
 Selection 6: specifies lamp 2 located in center of rocker.  
 Selection 7: specifies lamp 3 located above terminals 9 (+) & 10 (-).

No lamp	<b>0</b>			
LED	Red	Orange	Yellow	Green
12VDC	<b>A</b>	<b>C</b>	<b>E</b>	<b>H</b>
24VDC	<b>B</b>	<b>D</b>	<b>F</b>	<b>J</b>

**8 BRACKET COLOR**

**1** Black  
**4** Dark Carbon

**9 ACTUATOR**

Standard Rocker, Laser Etched

Black	Titan Gray	Dark Carbon
<b>M</b>	<b>N</b>	<b>R</b>

**10, 11, 12 LEGEND COLOR**

**Z** No legend  
**1** Clear  
**2** White

**13 LEGEND 1<sup>5</sup>**

**00** No legend  
 For legend options and codes, see pages 54-65 of this catalog

**14 LEGEND ORIENTATION**

**0** No legend  
**1** Orientation 1  
**2** Orientation 2  
**3** Orientation 3  
**4** Orientation 4

**15,16 LEGEND 2,3<sup>6</sup>**

**00** No legend  
 For legend options and codes, see pages 54-65 of this catalog

- NOTES**
- Indicates 1/2 travel for actuator.
  - Snap-Action Contact Mechanism
  - Not available with circuit 98.
  - Available with circuit 98 only.
  - Located over T1-2.
  - Legend 2 located in center of rocker. Legend 3 located over T9-10. Legend 2 options are limited due to a very small marking area. Consult factory for specifics.

## N-Series Rocker Switches



The N-Series Addressable Switch offers the look and feel of a traditional Electro-mechanical control coupled with a built in PCB to provide customers with a flexible, cost effective alternative to a CAN/LIN based switch. The N Series produces up to 144 individual switch IDs by using a resistive ladder circuit. Different switch IDs are achieved by changing the resistor values tied to individual loads. The individual loads can then be assigned to the specific functions that the switch is controlling. Each switch is connected to an ECU and the application software is written to recognize the switch IDs to determine which load is being controlled as well as the selected actuator position. The end result means that wiring harnesses are simplified and specific loads can now be controlled from any location within a vehicle cab. Switch locations can now be rearranged without the need for a costly and time consuming harness redesign, giving designers the ultimate in design flexibility.

### Electrical

Contact Rating . . . . .	.4VA @ 28VDC (MAX)
Dielectric Strength . . . . .	1250 Volts RMS between pole to pole 3750 Volts RMS between live parts and accessible surfaces
Insulation Resistance . . . . .	50 Megaohms
Contact Bounce. . . . .	20 milliseconds max.
Contacts . . . . .	gold plated
Terminals . . . . .	Brass or copper/silver plate 3/16" (4.76mm) Quick Connect terminations standard.

### Mechanical

Endurance . . . . .	250,000 cycles minimum
---------------------	------------------------

### Physical

Lighted . . . . .	Incandescent - rated 10,000 hours LED - rated 100,000 hours 1/2 life (LED is internally ballasted for voltages to 24VDC)
Seals . . . . .	Rocker, base & bracket are sealed.
Base . . . . .	Nylon 66 GF rated to 85°C with a flammability rating of 94V0.
Rocker and Paddle . . . . .	Nylon 66 Reinforced, rated to 105°C
Laser Etched Rocker. . . . .	Polycarbonate rated at 100°C.
Lens . . . . .	Polycarbonate rated at 100°C. Front snap-in.
Connector . . . . .	Nylon 66 rated at 85°C. Polarized.
Bracket . . . . .	Nylon Zytel

### Actuator Travel (Angular Displacement)

2 position . . . . .	26°
3 positions . . . . .	13° from center

### Environmental

Environmental . . . . .	IP67 for above the panel components of the actual switch, representing an index of protection as applied to electrical equipment in accordance with IEC 529, BS 5490, DIN 400 50 & NFC 20 010.
Operating Temperature . . . . .	-40°C to +85°C
Vibration . . . . .	Per SAE J1399 "electronic Tachometer Specification" for Class II truck and bus applications. Test Criteria: No change in resistance and no evidence of physical damage.
Salt Spray . . . . .	Exposure to 95% water, 5% NCl fog solution at 95 degrees F according to ASTM B 117-90 "Standard Test Method of Salt Spray (fog) Testing". Test Criteria: No visual evidence of corrosion or external physical damage.
Humidity . . . . .	Samples were exposed to selected temperature profile, while maintaining 90% +/- 5% relative humidity for 30 cycles. Test Criteria: No evidence of external physical deterioration.

### Mounting Specifications

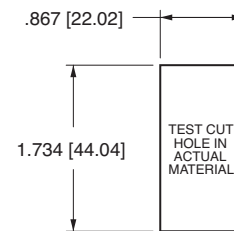

MOUNTING HOLE

#### Panel Thickness Range

Acceptable Panel Thickness  
.030 to .156 (.76mm to 3.96mm)  
Recommended:  
.030, .062, .093, .125 and .156



Dimensional Specifications in. [mm.]:

**N-SERIES**

SHOWN WITH LASER ETCHED ACTUATOR

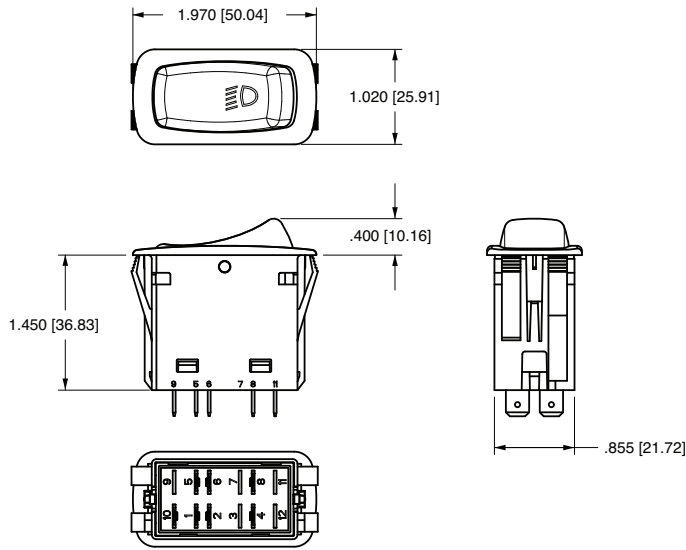

**N-SERIES**

SHOWN WITH ROCKER GUARD

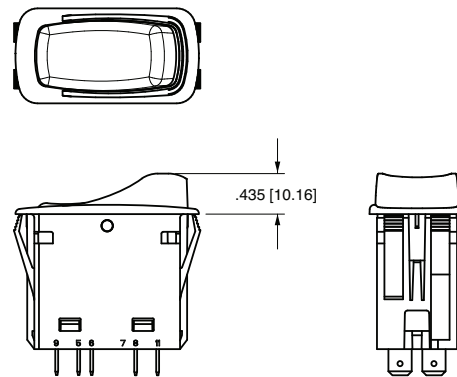

**N-SERIES**

SHOWN WITH LARGE LENS AND PADDLE ACTUATOR

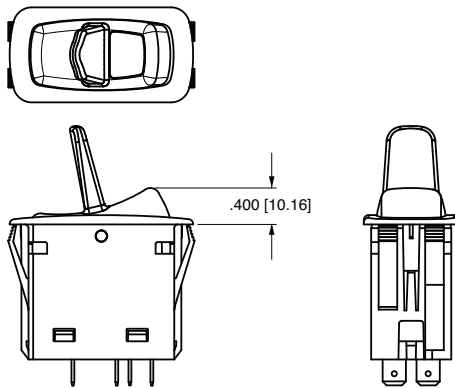

**N-SERIES**

SHOWN WITH BARS LENS AND CONNECTOR

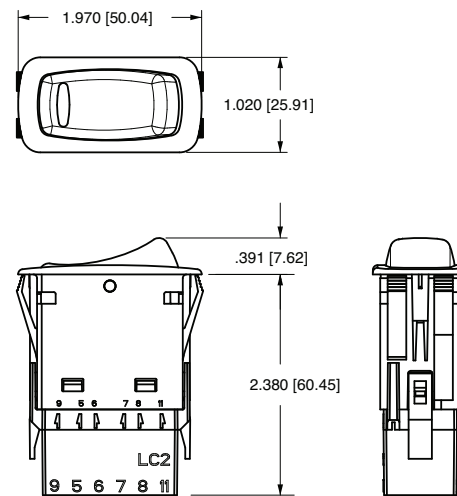

**N-SERIES**

LC2-01 BLACK .187 TAB CONNECTOR (PACKARD 480-SERIES)

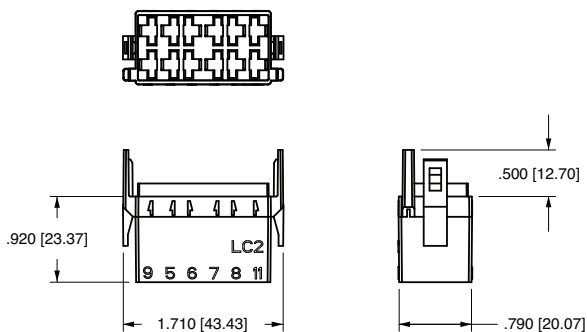

**N-SERIES**

LH1 REMOVABLE HOLE PLUG WITH NON-SERRATED WINGS  
LH2 HOLE PLUG WITH SERRATED WINGS

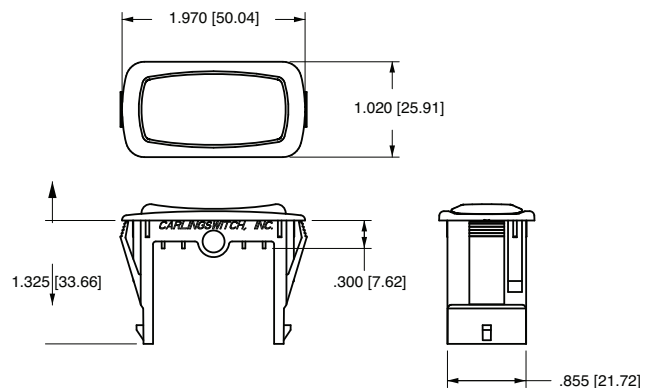

SWITCH CIRCUIT DIAGRAMS

CIRCUIT CODE	SCHEMATIC
4	
5	
6	
7	
8	

INTERNAL CIRCUIT BOARD (TYPICAL)

LAMP CIRCUIT DIAGRAMS

ILLUM. CODE	SCHEMATIC
A	
B	
C	
1	
2	
3	
4	

# N-Series Addressable Rocker Switches

**N 1 1 2 1 A N H 1 - 3 1 2 46 - 1 EK**

1 Series 2 Circuit 3 R1 Resistive ID 4 R2 Resistive ID 5 Resistor Constants 6 Illumination 7 Lamp 8 Lamp 9 Bracket 10 Actuator 11 Lens Style & Color Lamp 1 12 Lens Style & Color Lamp 2 13 Legend 14 Legend Orientation 15 Actuator Lens Legend

## 1 SERIES<sup>2</sup> N

### 2 CIRCUIT

Terminal Orientation

( ) - momentary

Position: 1 2 3

STANDARD	2 & 4	Connected Terminals	1 & 2
4	ON	NONE	ON
5	(ON)	NONE	ON
6	ON	ON	ON
7	(ON)	ON	ON
8	(ON)	ON	(ON)

### 3 R1 RESISTIVE IDENTIFICATION

1	1020	7	3570
2	1300	8	4320
3	1620	A	5230
4	2000	B	6340
5	2430	C	7870
6	2940	D	10000

### 4 R2 RESISTIVE IDENTIFICATION

1	1020	7	3570
2	1300	8	4320
3	1620	A	5230
4	2000	B	6340
5	2430	C	7870
6	2940	D	10000

### 5 RESISTOR CONSTANTS (INDICATES SWITCH STATE)

	R3	R4	R5
1	1300	10000	5320
2	825	6650	3830

### 6 ILLUMINATION

Lamp #1: above terminals 9 & 10 end of switch.; Lamp #2 above terminals 11 & 12 end of switch.  
Positive (+) and negative (-) symbols apply to LED lamps only.

Lamps	Illumination Type	Lamp wired to Terminals
S	None	
A # 1	Standard	10+ 12-
# 2	Standard	11+ 9-
B # 1 & 2	Special Parallel	11+ 9-
C # 1 & 2	Special Parallel	10+ 9-
1 # 1	Independent	10+ 9-
2 # 2	Independent	12+ 11-
3 # 1	Independent	10+ 9-
# 2	Independent	12+ 9-
4 # 1	Independent	10+ 9-
# 2	Independent	12+ 11-

### 7,8 LAMP (same coding for both selections)

Selection 7: above terminals 10 & 9; Selection 8: above terminals 12 & 11

No lamp 0

LED\* Red Amber Green  
12VDC C N H

\* Consult factory for "daylight bright", blue/green and white LED options.  
Typical current draw for LED is 20ma.

### 9 BRACKET COLOR<sup>1</sup>

Standard Bracket	Black	White	Gray	Red
Rockerguard at Lamp 1	A	B	C	D
Rockerguard at Lamp 2	E	F	G	H

### 10 ACTUATOR STYLE AND COLOR<sup>1</sup>

	Black	White	Gray	Red	Laser Etched
Rocker	A	B	C	D	1
Paddle	J	N	K	M	

### 11 & 12 LENS STYLE AND COLOR

Lens color for LEDs must be clear, white, or match color of LED.

0 - No Actuator	Z - No Lens				
Clear	White	Amber	Green	Red	Blue
1	-	B	G	M	T
-	7	C	H	N	U
3	-	D	J	P	V
-	9	E	K	R	W
5	A	-	-	-	-

Large Transparent  
Large Translucent  
Bar Transparent  
Bar Translucent  
Laser Etch background color

### 13 LASER ETCH, LENS OR BODY LEGEND

00 No legend this location / no actuator  
For legend options & codes, see pages 54-65 of this catalog.

### 14 LEGEND ORIENTATION

0 No legend (used with codes 11-18 in selection 12)

1 Orientation 1 - vertical, lamp 1 on top

2 Orientation 2 - horizontal, lamp 1 on right

3 Orientation 3 - vertical, lamp 1 on bottom

4 Orientation 4 - vertical, lamp 1 on left

### 15 ACTUATOR LENS LEGEND

00 No legend this location / no actuator  
For legend options & codes, see pages 54-65 of this catalog.

NOTES:  
1 Custom colors are available. Consult factory.  
2 Switch supplied with .187 tab terminals.

**LD-Series Electronic Dimmer Control**



The LD-Series represents a dynamic breakthrough in dashboard technology, with its programmable circuitry, superior design, and unparalleled performance that affords seamless integration into most any dash panel. A Variety of options, along with superior performance, functionality, and aesthetics assure compliance with the most stringent customer requirements. Key features include: robust design package with all components encased in switch housing, eliminating wire chafing, providing cost-savings as well; minimized electrical connections; IP67 sealing which prevents PCB degradation and eliminates short circuit potential. Superior heat dissipation is achieved with a heat sink mass which is over 50% larger than competitive products. Fully programmable circuitry lets the designer decide illumination levels and detent positions. EMC eliminates electrical "noise" and provides interference-free radio signals. Ease of assembly is accommodated with polarized integral connectors and an industry standard mounting hole.

**Electrical**

Contact Rating . . . . .	4 amps, 14VDC 7 amps, 14VDC 10 amps, 14VDC 2 amps, 28VDC 3.5 amps, 28VDC 5 amps, 28VDC
Contacts . . . . .	Solid State
Terminals . . . . .	.250 (6.3mm) Quick Connect terminations standard.
EMI/EMC . . . . .	Per SAE J 1113 & SAE J 1455
Reverse Polarity. . . . .	24VDC for 5 minutes
Dielectric Strength. . . . .	A potential of 1000V @ 60Hz was applied to each unit for one minute. The voltage was increased from 0 to 1000V at a rate of 500V per second and then reduced from 1000V to 0 at a rate of 500V per second. No noticeable signs of flashover, arcing or perforation were evident. All units operated properly both before and after test.
Electrical Endurance. . . . .	50,000 cycles minimum

**Mechanical**

Endurance . . . . .	100,000 cycles minimum
Actuation Force. . . . .	300 grams ± 50 grams

**Physical Characteristics**

Lighted . . . . .	LED - internally dimmed, rated 100,000 hours 1/2 life
Base . . . . .	PBT Polyester with VO flammability rating
Actuator . . . . .	Polycarbonate or Nylon 6/6 glass filled
Bracket . . . . .	PBT Polyester with VO flammability rating
Connector . . . . .	Nylon 6/6 toughened
Function . . . . .	Incremental or continuous dimming
Operation . . . . .	Momentary
Weight . . . . .	52 grams

**Environmental**

Operating Temperature . . . . .	-40°C to +85°C
Vibration . . . . .	Resonance Search Individual resonance searches were conducted with vibration applied along each of the three mutually perpendicular axes. 24-50 Hz 0.40 DA; 50-2000 ±10 G's peak Random Vibration The random vibration endurance test conditions were sequentially conducted in each of the three mutually perpendicular axes, 1hr/axis. 9.36 Grms Frequency (Hz) PSD (G <sup>2</sup> /Hz) 24 Hz 0.06 60 Hz 0.50 100 Hz 0.50 1000 Hz 0.025 2000 Hz 0.025 During this test, all units were operated at a load current of 2A with 12.5VDC.
Shock . . . . .	Per Mil-Std 202F, Method 213B, Test Condition K @ 30G's. Tested with connector. Test criteria - No loss of circuit during test, pre, & post test contact resistance.
Salt Spray . . . . .	Per Mil-Std 202F, Method 101D, Test Condition A, 96 Hrs.
Thermal Shock . . . . .	Per Mil-Std 202F, Method 107F, Test Cond. A, -55°C to 85°C. Test criteria - pre & post test contact resistance
Moisture Resistance . . . . .	Per Mil-Std 202F, Method 106E, Test Criteria - pre and post test contact resistance.
Dust . . . . .	Per Mil-Std 810C, Method 510.2 Air velocity 300± 200 ft/min, test duration 16 hr.
Temperature Cycle. . . . .	According to SAE J1455, Sec. 4.1.3.1 (See Figure below)

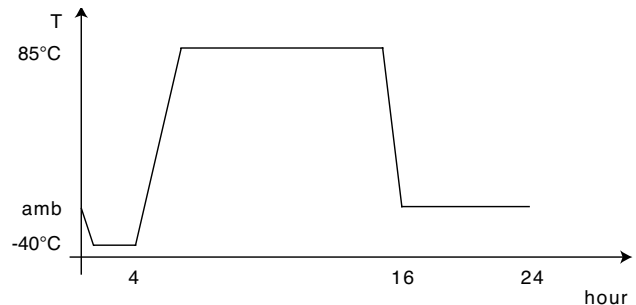

NOTES:  
For more detailed specifications, consult factory.



# LD-Series Electronic Dimmer Control

**LD 3 5 1 C C 1 - 3 A A FE - 1 FC**

1 Series      2 Rating      3 Dimming Rate      4 Termination      5 Illumination      6 Illumination      7 Bracket Color      8 Actuator Style/Color      9 Lens Color      10 Lens Color      11 Legend One      12 Legend      13 Legend Two Orientation

<b>1 SERIES</b>	
LD Electronic Dimmer Control	
<b>2 RATING</b>	
1 4A, 14 volt	3 10A, 14 volt      C 5A, 28volt
2 7A, 14volt	A 2A, 28 volt
<b>3 DIMMING RATE</b>	
1 30 - 100% 8 positions	A 0 - 100% 11 positions
5 10 - 100% 10 positions	
<b>4 TERMINATION</b>	
1 .250 TABS (6.4 mm)	
<b>5 &amp; 6 ILLUMINATION</b>	
No lamp S	
	Red Amber Green
12V LED C N H	
24V LED D P J	
<b>7 BRACKET COLOR<sup>1</sup></b>	
1 Black	2 White      3 Gray
<b>8 ACTUATOR STYLE / COLOR<sup>1</sup></b>	
	Laser Etched Black White Gray Red
Rocker 3	A B C D
Paddle 4	J K M N

<b>9 &amp; 10 LENS COLOR</b>						
Z NO LENS						
CLEAR	WHITE	AMBER	GREEN	RED	BLUE	LENS STYLE
1 -	B	G	M	T		Large
-	7 C	H	N	U		Transparent Large
3 -	D	J	P	V		Translucent Bar
-	9 E	K	R	W		Transparent Bar
5 A	-	-	-	-		Translucent Laser Etch

<b>11 LEGEND #1</b>		
00 No legend	FC DIM	FE BRIGHT
For additional legend options, see pages 54-65 of this catalog.		

**12 LEGEND ORIENTATION**

0 No legend  
 1 vertical (lamp 1 on top)  
 2 horizontal (lamp 1 on right)  
 3 vertical (lamp 1 on bottom)

<b>13 LEGEND #2</b>		
00 No legend	FC DIM	FE BRIGHT
For additional legend options, see pages 54-65 of this catalog.		

NOTES  
 1 Custom colors are available. Consult factory.

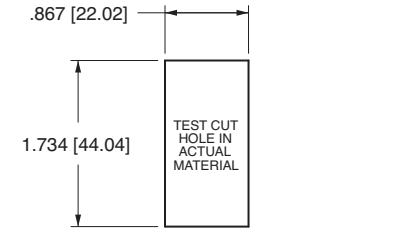
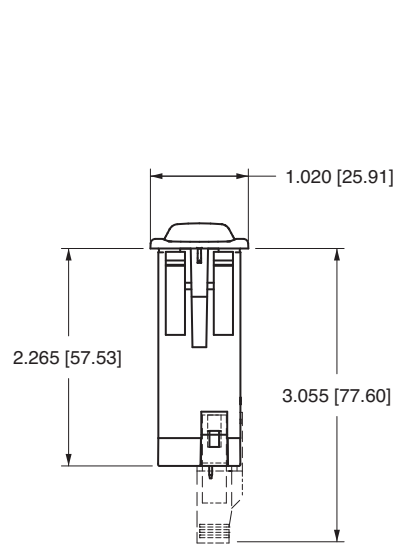
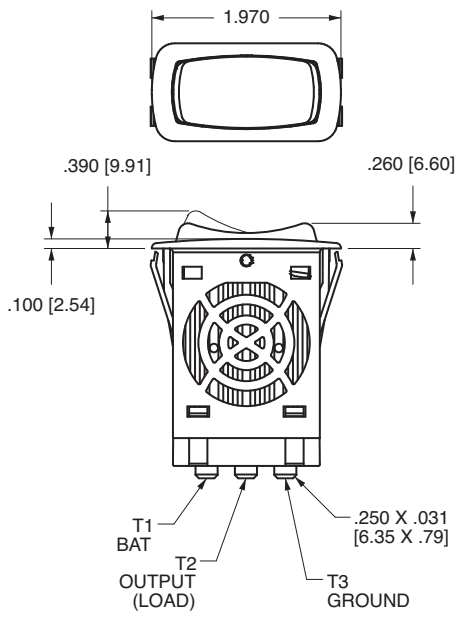

**MOUNTING HOLE**  
**Panel Thickness Range**  
 Acceptable Panel Thickness  
 .030 to .156 (.76mm to 3.96mm)  
 Recommended:  
 .030, .062, .093, .125 and .156

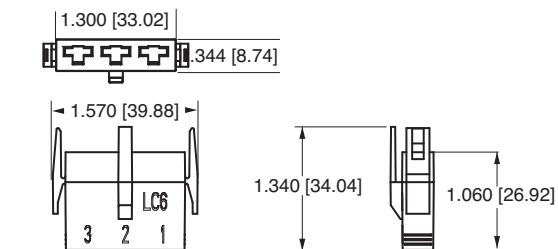
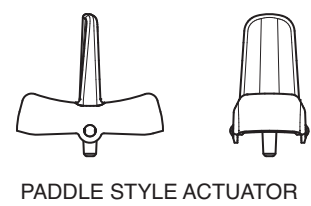

Q.C. SELECTION GUIDE			
COMPANY SERIES	PACKARD PART NO.	WIRE GAGE	
		AWG	MM <sup>2</sup>
PACKARD METRI-PACK 630 SERIES TIN PLATED BRASS	12084590	12	3.0
	12052224	12	3.0
	12015870	16-14	2.0-1.0
	12015869	20-18	1.0-.80
	12020035	22-18 (2 REQ'D)	.80-.50 (2 REQ'D)
	12052222	20-22	.50-.35

LMR-Series Mirror Rotate Control



As an extension of the L-Series family of control products, the LMR-Series provides the means to control one or two mirrors and up to four separate motors from one easy to operate joy stick control. When used in conjunction with our dimmer control, and wiper/washer control, Carling Technologies provides a solution to most any dashboard control need within the Transportation market.

**Actuator**  
4 axis joy stick style  
**Electrical**  
1A 14V; .5A 28V  
**Sealing**  
internal boot and potted wire leads protect critical components from dust and moisture  
**Termination<sup>1</sup>**  
9" wire leads with Delphi-Packard connector #12047886  
**Mechanism**  
Sliding contacts in conjunction with a circuit board

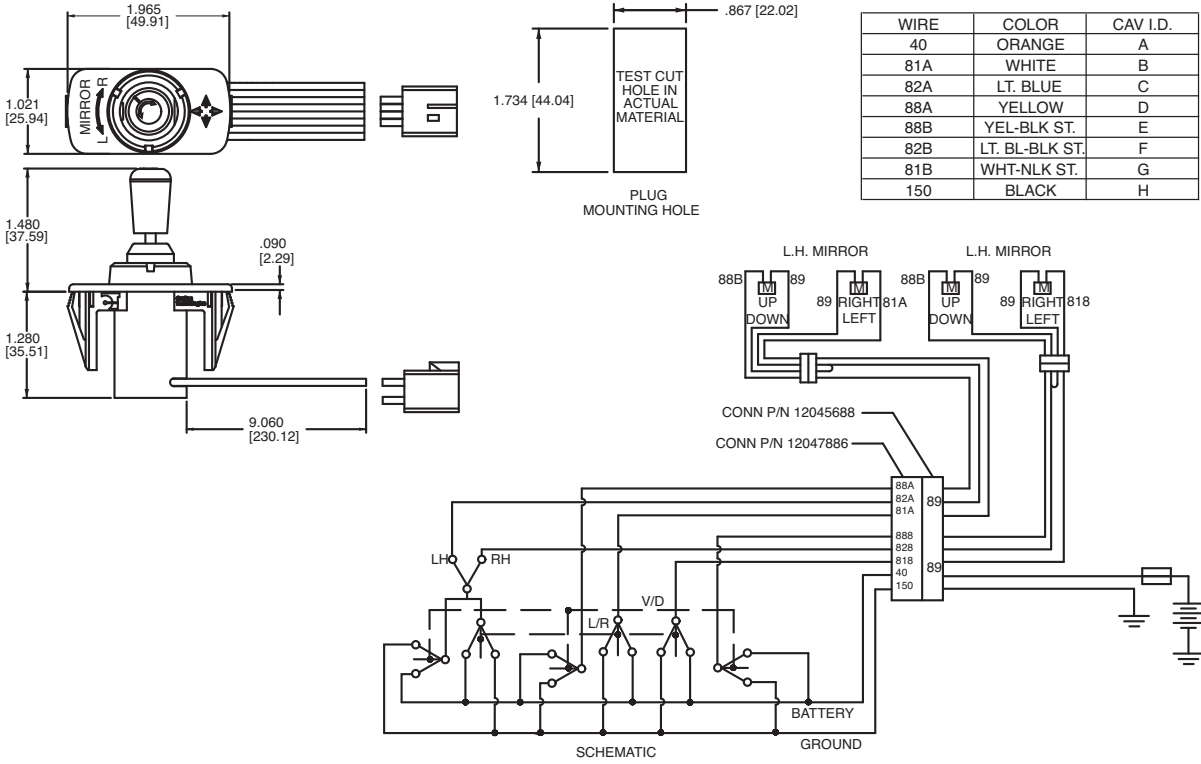

**LMR** - **01** - **1**

1 Base Part Number      2 Color      3 Legend

- 1 BASE PART NUMBER: SERIES/RATING/FUNCTION/TERMINATION**  
LMR 2 position (left, right), 4 axis (N,S,E,W) with wire leads
- 2 ACTUATOR /BRACKET COLOR**  
01 black
- 3 LEGEND<sup>2</sup>**  
Z no legend  
1 2 arrows symbol (left, right)  
2 4 arrows symbol (front, back and left, right)

NOTES  
 1 Compatible with Delphi-Packard #12045688.  
 2 All legends are imprinted in white. All product supplied with Mirror L & R legend on top of bracket and detent and directional legend on actuator.  
 Delphi-Packard is a registered trademark of Delphi-Packard Electrical Systems, Warren, Ohio.

LW-Series Wiper/Washer Control



Carling Technologies Electronic Wiper Washer Control combines 2 switches into 1 self-contained unit allowing effortless control of both wash and wipe functions from a singular location. A variety of features and options including, Continuous low and high speed wiper positions, Six intermittent delay intervals ranging from 3-18 seconds, Push-to-wash button and an LED Night-light indicator combine to provide the flexibility to meet most any Cab design. The LW series is available for 14 or 28 volt operation and can be adapted to single or dual relay systems.

**Electrical**

Current Rating . . . . . **1 relay**  
 8 amps, 14VDC  
 4 amps, 28VDC  
**2 relays**  
 1 amps, 14VDC  
 1 amps, 28VDC

Terminals . . . . . .187 (7.4mm) Quick Connect terminations standard.

Electrical Properties . . . . . Reverse polarity protection  
 Over voltage protection  
 Cold cranking protection according to SAE J1455, Sections. 4.11.1.1 and 4.11.1.2.1  
 Transient voltage protection which includes load dump and inductive switching according to SAE J1455, sec. 4.11.2.2  
 Electrostatic discharge protection according to SAE J1455 Sec. 4.11.2.2.5.1 (Discharge a 150 pf capacitor that has been charged to a potential of 15kV through 150 Ohm resistor.)  
 Meets all other EMI/EMC requirements for class C trucks.

**Mechanical**

Mechanical Vibration . . . . Sinusoidal Vibration: 10-55-10 Hz, 0.06" DA, one minute-cycle, three hours/axis  
 Random Vibration: Three hours/axis, three mutually perpendicular axes with a test level 4G's.  
Frequency    Amplitude  
 5Hz            0.16 G<sup>2</sup>/Hz  
 100Hz        0.16 G<sup>2</sup>/Hz  
 500Hz        -3dB/octave roll-off  
 Tests were conducted according to SAE J1455, Sec 5.7 and Sec. 4.9.4.  
 Shock: MIL-STD-202G Method 213B, Test Condition K, 30G's, 11 ms.

Endurance Test . . . . . According to SAE J2349, March 97 for windshield washer switch for Trucks, Buses and Multipurpose Vehicles (20,000 cycle minimum).

NOTES:  
 For more detailed specifications, consult factory.

**Physical Characteristics**

Illumination . . . . . LED, rated 100,000 hours 1/2 life  
 Cover . . . . . Acetate  
 Washer Actuator . . . . . Silicone  
 Toggle Actuator . . . . . Nylon 6/6 glass filled  
 Bracket . . . . . Nylon 6/6  
 Connector . . . . . Nylon 6/6 rated 85°C polarized  
 Washer Function . . . . . Momentary  
 Toggle Function . . . . . Maintained Intermittent  
 Operation . . . . . Momentary  
 Weight . . . . . 44 grams

**Environmental**

Operating Temperature . . . -25°C to +85°C  
 Temperature Cycle . . . . . According to SAE J1455, Sec. 4.1.3.1 (See Figure below)

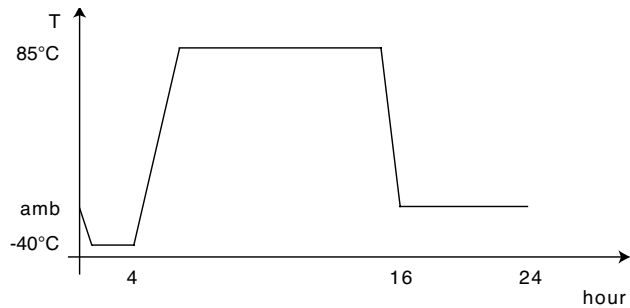

Thermal Shock . . . . . According to SAE J1455, Sec. 4.1.3.2 (See Figure below)

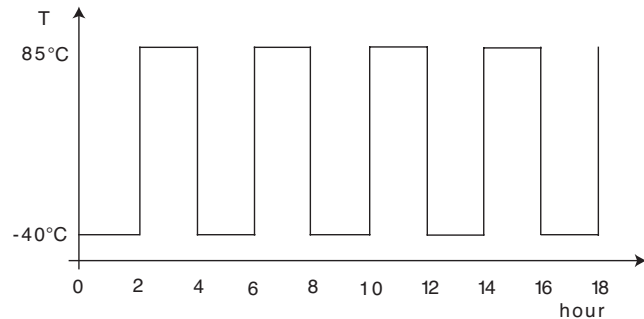

Humidity . . . . . According to SAE J1455, Sec. 4.2.3 (30 cycles for 8 hrs. with maximum temperature of 85°C and 95% relative humidity).

Dust Bombardment . . . . . According to SAE J1455, Sec. 4.7.3 (with dust concentration of 0.88gm/m for 24 hours.)

Salt Spray . . . . . MIL-STD-202G, Method 101D for 96 hours.

**LW 1 A 1 1 Z - 1 1 AG 1 00**

1 Series      2 Rating      3 Intermittent Timing      4 Wiper/Washer Timing      5 Lamp #1      6 Lamp #2      7 Bracket Color      8 Rocker/Paddle Color      9 Legend One      10 Legend Orientation      11 Legend Two

**1 SERIES**  
**LW** Wiper/Washer Control with six intermittent positions: low, high, wash/wipe

**2 RATING<sup>1</sup>**  
**1** 8A, 14VDC (1 relay)      **4** 1A, 14VDC (1 relay)  
**2** 4A, 28VDC (1 relay)      **5** 1A, 14VDC (2 relay)  
**3** 1A, 14VDC (1 relay)      **6** 1A, 28VDC (2 relay)

**3 INTERMITTENT TIMING**  
**A** 2-15 seconds

**4 WIPER/WASHER TIMING**  
**1** 3 seconds

**5 LAMP #1 (above wash)**  
**Z** no lamp      **2** red LED  
**1** green LED      **3** amber LED

**6 LAMP #2 (above wipe)**  
**Z** no lamp      **2** red LED  
**1** green LED      **3** amber LED

**7 BRACKET COLOR**  
**1** black

**8 ROCKER/PADDLE COLOR**  
**1** black

**9 LEGEND #1**  
**00** No legend  
 For legend options, see pages 54-65 of this catalog.

**10 LEGEND ORIENTATION**  
**0** No legend  
**1** vertical (lamp 1 on top)  
**2** horizontal (lamp 1 on right)

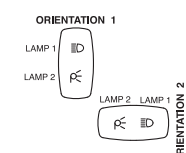

**11 LEGEND #2**  
**00** No legend  
 For legend options, see pages 54-65 of this catalog.

**NOTES**

1 Relay coil current is 1A max. Relay must have an arc suppression in parallel with the coil. Ref P/N LC2-01 for black wiper/washer connector housing.

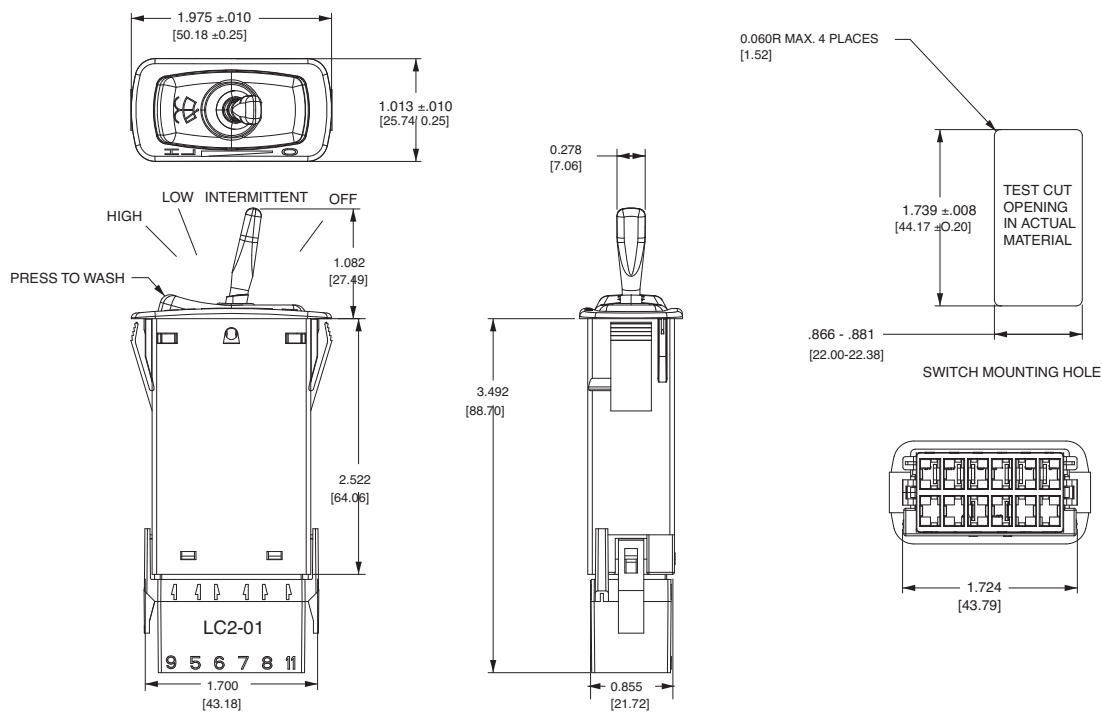

**Principles of operation:**

From the OFF position, moving the toggle one step up puts the function into the intermittent slower mode (18 sec.). Moving the toggle another step up reduces the delay time by 3 sec for each of the next six steps. The seventh step up puts the motor into a continuous low-speed mode and the last step up puts the motor into the high-speed mode. Reversing the previous steps puts the motor finally into the stop/parking mode. During the OFF position, intermittent and low-speed modes, pressing the wash button activates the wash function. Wipe function starts after a two second delay from the onset of the washing and continues for three continuous wipes after the wash button is released. For convenience, the wash function is not active during the high-speed mode.

The Wiper Control is designed to interface with single or dual relay systems for intermittent delay and the park function. The high speed is driven directly via a power transistor internal to the module. The coil of the relay is pulled down to ground during the intermittent, low-speed and high-speed modes respectively. (Contact Carling Technologies for wiring diagrams)

## Cruise Control



The cruise control assembly digitally communicates with the VECU to provide the proper signal when the operator presses a button on one of the controls. The left control includes acceleration and deceleration, while the right control panel includes the OFF/ON and Resume buttons.

This product withstands temperatures from  $-40^{\circ}\text{C}$  to  $+85^{\circ}\text{C}$ , relative humidity up to 95%, condensation, direct sunlight and mechanical vibrations. The two controls are housed in an integrated assembly to minimize wiring. The expert design integrates seamlessly with the vehicle steering and wheel styling and is designed to meet customer-specific requirements for safety and ease of accurate assembly. Carling engineers will work with you and your vehicle design team to develop a customized cruise control solution for your specific needs.

## Horn Control



The horn control is housed in an integrated assembly to minimize wiring and provides a flexible, yet durable actuator cover to endure exponential presses. It withstands temperatures from  $-40^{\circ}\text{C}$  to  $+85^{\circ}\text{C}$ , relative humidity up to 95%, condensation, direct sunlight and mechanical vibrations and was designed as a cost-effective alternative to traditional horn controls. This rugged control has an operating voltage of 12 to 24VDC. Carling engineers will work with you and your vehicle design team to develop a customized cruise control solution for your specific needs.

## Light Control Module



The light control module is a multifunctional package that encompasses four critical controls within one easy-to-install, space saving unit. Controls include a high-current rotary switch, which controls parking lights and headlights; a push-pull feature on the switch to operate fog lights; an adjacent high-current thumbwheel dimmer switch to select the desired brightness for dash lighting; and an additional miniature rocker switch for auxiliary high-current lighting functions.

The light control module is a compact, sleek, operator friendly, cost effective module. The rugged high-current switch design allows high-current loads to be handled without the need to include costly relays in the switch circuit. The snap-in design and integrated keyed connector make installation easy, and the compact design uses little valuable dashboard space.

## HVAC Motor Controller

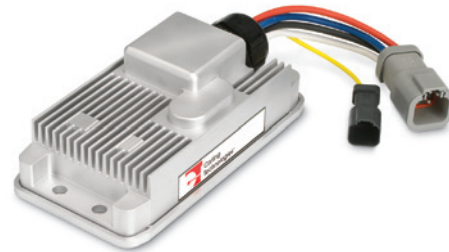

The HVAC motor controller efficiently controls heating and ventilation and interfaces with the vehicle's VECU to adjust the speed of the HVAC blower motor. There are two connections in the controller, one to the load through the harness and another to the VECU. The signal from the VECU controls the motor speed and creates a soft start that will suppress any inrush during the motor's start up.

The HVAC motor controller operates at 12 or 24VDC and drives DC motors up to 30A. It provides overvoltage protection, up to 100V for two minutes, meeting automotive requirements for EMC, vibration and shock. These features help extend the life of the HVAC unit and prevent the nuisance blowing of fuses or circuit breakers. The HVAC controller is sealed to IP68, providing protection from the extreme environmental conditions experienced by the blower housing. The HVAC Motor Controller is compact and uses fewer components and connections than traditional motor control devices.



## Keypads



Operator control modules utilize industry standard SAE J1939 CAN and NMEA communication protocols. By incorporating a single connector to the CAN bus via a communications cable, wire harnesses are greatly simplified, saving space, weight and cost. Through the use of embedded software, these modules are configurable to your specific load requirements and diagnostic needs.

The compact keypad, available in standard or custom silicone designs, is the perfect interface for the many HMI functions that it controls. These sleek control pads provide a distinctive tactile feel for the operator, while incorporating wear-resistant lasered graphics for long life. Operator Control Modules are available with many features including multiple function lighting, CAN data-controlled variable dimming, and backlighting



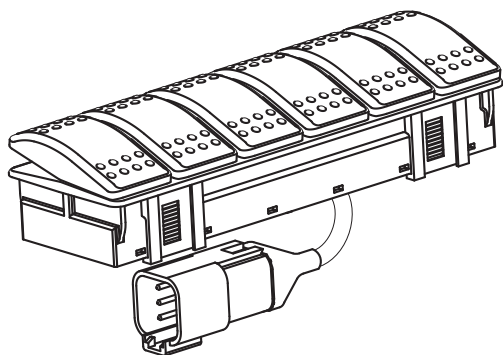



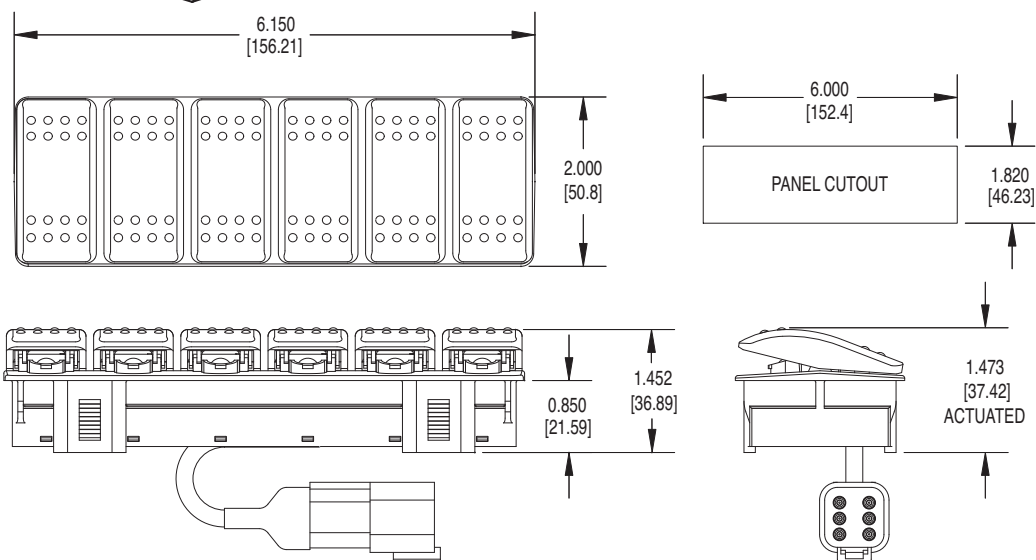









## Multiplexed V-Series Rocker Modules



















Multiplexed V-Series rocker modules use industry standard SAE J1939 and NMEA communications protocols. The rocker module provides the look and feel of a traditional electromechanical switch with the connection benefits of a multiplexed module. Using one cut-out for six switch functions, the multiplexed V-Series rocker modules save assembly time, and greatly simplify wiring and harness requirements, providing a high-tech yet cost-effective solution.



# Legend Imprinting

LEGEND		LEGEND CODE		
SYMBOL	NAME (SYMBOL MEANING)	BODY	LENS	
			NEGATIVE <sup>1</sup>	POSITIVE
	RUNNING LIGHTS (UNDER POWER)	AA	NA	MA
	LIGHT	AB	NB	MB
	MASTER LIGHT SWITCH	AC	NC	MC
	HORN	AD	ND	MD
	PROPULSION SYSTEM TRIM TRIMMING OPERATION	AE	NE	ME
	VENTILATION FAN OR BLOWER	AF	NF	MF
	WINDSHIELD WASHER	AG	NG	MG
	WINDSHIELD WIPER	AH	NH	MH
	BILGE PUMP	AJ	NJ	MJ
	BILGE BLOWER	AK	NK	MK
	POTABLE WATER PRESSURE	AL	NL	ML
	ENGINE START	AM	ED	MM
	ENGINE STOP	AN	EE	MN
	DRIVE TILT TILT OPERATION	30		31
	EMERGENCY START	32		33
	UP/DOWN LIFT	34		
	TRIM TAB TRIMMING OPERATION	35		36

LEGEND		LEGEND CODE		
SYMBOL	NAME (SYMBOL MEANING)	BODY	LENS	
			NEGATIVE <sup>1</sup>	POSITIVE
	ANCHOR LIGHT	37		38
	ANCHOR	39		40
	WATER FLUSHING TAP FOR OUTBOARDS	41		42
	HIGH BEAM	43	44	45
	LOW / DIPPED BEAM	46	47	48
	SIDE MARKER LIGHT	DG	49	DF
	INTERIOR LIGHT	50	51	52
	WORK LIGHT	53	54	55
	WORK LAMP	56	57	58
	LOADING FLOOR LAMP	CW	59	CY
	ON -WIPER- INT DELAY	60		
	ROTARY BEACON	61	62	63
	LAMP TEST	DK	64	DL
	WINDSHIELD WIPER/WASHER	65	66	67
	HAZARD WARNING	68	69	70
	WARM AIR BLOWER	71	72	73
	HORN REAR	AX	74	Y4





## NOTES





Legends shown represent positive lens legend, where image is stamped on lens. On negative lens legends, the background is stamped black so that only the image will be illuminated when the switch is actuated. Legend size may vary on V, L, N, and S-Series switches.

1 Negative legends not available on L, LD, LW, and N-Series.

2 Many symbols are SAE (J1362), ANSI and ISO approved symbols. Consult factory for custom symbols/icons.

3 Use "body" legend codes for laser etched image identification.

LEGEND		LEGEND CODE		
SYMBOL	NAME <small>(SYMBOL MEANING)</small>	BODY	LENS	
			NEGATIVE <sup>1</sup>	POSITIVE
	REAR FOG LAMP	75	76	77
	DIFFERENTIAL LOCK	78	79	80
	ALL WHEEL DRIVE	81	82	83
	DIRECTION INDICATOR	84	85	86
ENG HATCH		87		88
HORN		89		90
BLOWER		91		92
DEPTH		93		94
BILGE PUMP		95		96
NAV LTS		97		98
COURT LTS		99		1A
PANEL LTS		1B		1C
ANCH LTS		1D		1E
TRIM TAB		1F		1G
WATER PUMP		1H		1J
WIPER		1K		1L
BILGE		1M		

LEGEND		LEGEND CODE		
SYMBOL	NAME <small>(SYMBOL MEANING)</small>	BODY	LENS	
			NEGATIVE <sup>1</sup>	POSITIVE
ENG COMP		1N		1P
ACC		1R	1S	1T
NAV ANC		1U		1V
WNDLS UP/DN		1W		1Y
NAV ANCH LTS		1Z		2A
WNDLS ON/OFF		2B		2C
DOCKING LTS		2D		2E
	MUSIC	2F		2G
	BATTERY	2H	FM	2J
	LEVER UP/DOWN	2K		
	ENG PREHEAT	2M	EA	2N
UP		2P		2R
ANTENNA		2S		
DOWN		2T		
PRESS		2U		
AUX START		2V		2W
	GAS	2Y	EB	2Z

NOTES

Legends shown represent positive lens legend, where image is stamped on lens. On negative lens legends, the background is stamped black so that only the image will be illuminated when the switch is actuated. Legend size may vary on V, L, N, and S-Series switches.

1 Negative legends not available on L, LD, LW, and N-Series.

2 Many symbols are SAE (J1362), ANSI and ISO approved symbols. Consult factory for custom symbols/icons.

3 Use "body" legend codes for laser etched image identification.

# Legend Imprinting

LEGEND		LEGEND CODE		
SYMBOL	NAME <small>(SYMBOL MEANING)</small>	BODY	LENS	
			NEGATIVE <sup>1</sup>	POSITIVE
	RIDE CONTROL	3A	EN	3B
	KICK OUT	3C		3D
	BEACON	3E	EP	3F
	SLOW	3G		3H
	CHECK	3J	DJ	3K
	A/C	3L		3M
	REAR DEFOGGER	3N	3P	3R
	FORK LIFT	3S	ER	3T
	ENG PREHEAT	3U		3V
	REAR WINDOW WIPER	AY	3Y	Y5
REAR				EC
	EXCAVATOR BACKHOE BOOM SHIFT	4B		4C
	UNLOCK	4D		4E
	TRANSMISSION LOCK	4F		4G
	FORK LIFT DOWN / UP	4H		

LEGEND		LEGEND CODE		
SYMBOL	NAME <small>(SYMBOL MEANING)</small>	BODY	LENS	
			NEGATIVE <sup>1</sup>	POSITIVE
	DRIVER SEAT LIGHTING	4J		4K
	SIDE MARKER LAMPS	4L	4M	4N
	FOG LAMP	4P	4R	4S
	TRUNK LIGHT	4T		4U
RED		4V		4W
AMBER		4Y		
	LINE INDICATOR	5B		5C
	HANDICAP	5D	BX	5E
	STOP REQUEST	5F		5G
	WINDSCREEN HEATING & VENTILATION	5H	FP	5J
	EXTERIOR MIRROR DEFROSTER	5K		5L
	MOMENTARY LEVER	5M		5N
	SLOW	5P		5R
HIGH		5T	Y6	5U
LOW		5V	Y7	5W
PARK		5Y		5Z













**NOTES**

Legends shown represent positive lens legend, where image is stamped on lens. On negative lens legends, the background is stamped black so that only the image will be illuminated when the switch is actuated. Legend size may vary on V, L, N, and S-Series switches.

1 Negative legends not available on L, LD, LW, and N-Series.

2 Many symbols are SAE (J1362), ANSI and ISO approved symbols. Consult factory for custom symbols/icons.

3 Use "body" legend codes for laser etched image identification.

LEGEND		LEGEND CODE		
SYMBOL	NAME <small>(SYMBOL MEANING)</small>	BODY	LENS	
			NEGATIVE <sup>1</sup>	POSITIVE
WASHER		6C		
	SUPPLEMENTAL STEERING	6D		6E
BATT PARL		6F		6G
	DEPTH SOUNDER	6H		6J
	MUTE	6K		6L
T I M E R		6M		
M A N		6N		
LIVEWELL		6R		
	WATER TANK		6S	
	REAR WASHER/WIPER	6T	BY	6U
	FRONT DIFFERENTIAL LOCK	6V		6W
	LEVER UP/DOWN	6Y		
	BILGE PUMP#1	6Z		7A
	BILGE PUMP#2	7B		7C
	BILGE PUMP#3	7D		7E
	RIGHT STABILIZER	7F		7G
	LEFT STABILIZER	7H		7J

LEGEND		LEGEND CODE		
SYMBOL	NAME <small>(SYMBOL MEANING)</small>	BODY	LENS	
			NEGATIVE <sup>1</sup>	POSITIVE
HEAD LIGHTS		7K		EJ
CL / ID LIGHTS		7L		
CRUISE CONTROL		7M		
SET/DECEL RES/ACCEL		7N		
ENGINE BRAKE		7P		
HIGH MED LOW		7R		
POWER WINDOW		7S		
ENGINE FAN		7T		
DRIVING LIGHTS		7U		
FOG LIGHTS		7V		
TRAILER CL / ID LIGHTS		7W		
ENGINE DIAGN		7Y		
LH/RH TANK		7Z		
MIRROR DEFOG		8A		
BACKUP LIGHTS		8B		
DASH LIGHTS		8C		
CAB SLEEPER		8D		

NOTES

Legends shown represent positive lens legend, where image is stamped on lens. On negative lens legends, the background is stamped black so that only the image will be illuminated when the switch is actuated. Legend size may vary on V, L, N, and S-Series switches.

1 Negative legends not available on L, LD, LW, and N-Series.

2 Many symbols are SAE (J1362), ANSI and ISO approved symbols. Consult factory for custom symbols/icons.

3 Use "body" legend codes for laser etched image identification.



# Legend Imprinting

LEGEND		LEGEND CODE		
SYMBOL	NAME <small>(SYMBOL MEANING)</small>	BODY	LENS	
			NEGATIVE <sup>1</sup>	POSITIVE
	SLEEPER START	8E		
	HIGH LOW	8F		
	CRUISE CONTROL	8G	8H	8J
	CRUISE CONTROL ADJUST	8K	8L	8M
	ENGINE BRAKE	8N	8P	8R
	HIGH/MED/LOW	8S	8T	8U
	POWER WINDOW	8V	8W	8Y
	ENGINE FAN	8Z	9A	9B
	DIAGNOSTICS	9C	9D	9E
	LH/RH TANK	9F	9G	9H
	LENS BLACKOUT		9J	
	VARIABLE	9L	9M	9N
	MIRROR ADJUST	9P	9R	9S
	SPEAKER	9T		9U
	SLEEPER START	9V	9W	9Y
	HIGH / LOW	9Z	A1	A2
	BEACON	A3		

LEGEND		LEGEND CODE		
SYMBOL	NAME <small>(SYMBOL MEANING)</small>	BODY	LENS	
			NEGATIVE <sup>1</sup>	POSITIVE
	MIRROR	A4		
	MASTER SWITCH	A5		A6
	RABBIT (FAST)	A7		A8
	RETARDER	A9		B1
	EXHAUST BRAKE	B2	BZ	B3
	TANDEM AXLE	B4		B5
	AIR TANK	B6		B7
	DRAIN	B8		
	AUTOMATIC TRANSMISSION	B9	EX	C1
	LOADER BUCKET DOWN	C2		C3
	LOADER BUCKET	C4		C5
	AUTO	C6		
	NEUTRAL LOCK	C7	EF	C8
	TRANSMISSION NEUTRALIZER	C9		D1
	RUNNING / ANCHOR LIGHTS	D2		
	TRIM TAB TRIMMING OPERATION	D3		D5
	TRACTOR FORWARD	D6		D7













## NOTES











Legends shown represent positive lens legend, where image is stamped on lens. On negative lens legends, the background is stamped black so that only the image will be illuminated when the switch is actuated. Legend size may vary on V, L, N, and S-Series switches.

1 Negative legends not available on L, LD, LW, and S-Series.

2 Many symbols are SAE (J1362), ANSI and ISO approved symbols. Consult factory for custom symbols/icons.

3 Use "body" legend codes for laser etched image identification.

LEGEND		LEGEND CODE		
SYMBOL	NAME (SYMBOL MEANING)	BODY	LENS	
			NEGATIVE <sup>1</sup>	POSITIVE
	STEERING	D8	FN	D9
BATTERY PARALLEL		E1		
	MIRROR DEFROST	DD	E2	DE
	SLEEPER LIGHTS		E3	
	IDLE SPEED	FB	E4	FAFN
SLEEPER LIGHTS		E5		
IDLE SPEED		E6		
	MOWER DECK UP/DN	E7		E8
	4 / 2 WD LOCK	E9		F1
	STEERING CONTROL	F2		F3
	DRIVE TILT UP	F4		F5
	MILL MAIN	F6		F7
	MILL REVERSAL	F8		F9
	HEAD LIGHTS	G1		G2
	WORK LIGHT	G3		G4
RAISE		G5	EY	G6
LOWER		G7	Ez	G8

















LEGEND		LEGEND CODE		
SYMBOL	NAME (SYMBOL MEANING)	BODY	LENS	
			NEGATIVE <sup>1</sup>	POSITIVE
FWD		G9		H1
REV		H2		H3
	BROOM	H4		H5
	SANDER	H6		H7
KNEEL		H8		
	CHIME MUTE	DY	H9	DZ
R. DOOR		J1		J2
F. DOOR		J3		J4
AUX BATT		J5		J6
	SWING MAIN	J7		J8
	ACTIVE SWING	J9		K1
	CENTERING	K2		K3
	REAR OPERATION AUTO-LIFT RELEASE	K4		K5
		K6		K7
	ARROW		K8	
	FRONT WINDOW DEFROST	K9		L1
	REAR WINDOW DEFROST	L2		L3

















NOTES

Legends shown represent positive lens legend, where image is stamped on lens. On negative lens legends, the background is stamped black so that only the image will be illuminated when the switch is actuated. Legend size may vary on V, L, N, and S-Series switches.

- 1 Negative legends not available on L, LD, LW, and N-Series.
- 2 Many symbols are SAE (J1362), ANSI and ISO approved symbols. Consult factory for custom symbols/icons.
- 3 Use "body" legend codes for laser etched image identification.

# Legend Imprinting

LEGEND		LEGEND CODE		
SYMBOL	NAME (SYMBOL MEANING)	BODY	LENS	
			NEGATIVE <sup>1</sup>	POSITIVE
	SIDE WINDOW DEFROST	L4		L5
		L6		L7
	CRAWLER STRETCHING	L8		L9
	CRAWLER LOOSENING	M1		M2
	SEARCH LIGHT	M3		M4
	SIDE MIRROR DEFROST	M5		M6
		M7	CA	M8
	UNLOADER AUGER	M9		N1
	REVERSING	N2		N3
	DRIVING LIGHT	N4		N5
	HAZARD	N6		N7
	EXTRA PLUG	N8		N9
	GRAIN TANK LIGHT	P1		P2
	ROTOR LIGHT	P3		P4
	CHAFF SPREADER	P5		P6
	HANDLE	P7	EM	P8
	LEFT / RIGHT TABLE	P9		R1

LEGEND		LEGEND CODE		
SYMBOL	NAME (SYMBOL MEANING)	BODY	LENS	
			NEGATIVE <sup>1</sup>	POSITIVE
	LEFT SIDE KNIFE	R2		R3
	ALL MECHANISMS	R4		R5
	MONITOR MENU	R6		R7
	VERTICAL BAR	S1		S2
	THRESHING SYSTEM	S3		S4
	TABLE MOVEMENT	S5		S6
	CYLINDER SPEED	S7		S8
	COVER PLATE	S9		T1
	ENGINE STARTING AID	T2		T3
	TRACTION CONTROL SYSTEM	T4		T5
	HYDRAULIC DIVERTER VALVE	T6		T7
	LAMP TEST	T8	T9	U1
	DOCKING LIGHT	U2		U3
	ROCKSHAFT	U4		U5
	AUX	U6	EG	U7
	DOCK LIGHTS	U8		
	CTSY LIGHTS	U9		

## NOTES

Legends shown represent positive lens legend, where image is stamped on lens. On negative lens legends, the background is stamped black so that only the image will be illuminated when the switch is actuated. Legend size may vary on V, L, N, and S-Series switches.

1 Negative legends not available on L, LD, LW, and N-Series.

2 Many symbols are SAE (J1362), ANSI and ISO approved symbols. Consult factory for custom symbols/icons.

3 Use "body" legend codes for laser etched image identification.

LEGEND		LEGEND CODE		
SYMBOL	NAME <small>(SYMBOL MEANING)</small>	BODY	LENS	
			NEGATIVE <sup>1</sup>	POSITIVE
	TRIM	V1		
	AIR TEMP SEA	V2		
	ENGINE LIGHTS	V3		
	TRANS LIGHTS	V4		
	DEFOG	V5		
	SEAT	V6		
	UP TRAILER	V7		EH
	DEPTH FINDER	V8		
	EXHAUST	V9		
	SINK PUMP	W1		W2
	STORAGE LIGHTS	W3		
	UP HATCH DOWN	W4		
	TRAILER 3rd AXLE LIFT	W5	W6	W7
	TRAILER 3rd AXLE LIFT	W8		
	HANDLE BAR HEATER	W9		Y1
	PARKING BRAKE	Y2	DH	Y3
	ARROW (UP)	Y8	ES	Y9

LEGEND		LEGEND CODE		
SYMBOL	NAME <small>(SYMBOL MEANING)</small>	BODY	LENS	
			NEGATIVE <sup>1</sup>	POSITIVE
	ARROW (DOWN)	Z1		Z2
	RIGHT SIDE KNIFE	Z3		Z4
	HYDRAULIC HAMMER	Z5		Z6
	HYDRA-CLAMP	Z7		Z8
	SHOVEL FLOAT	Z9		AP
	SHOVEL HORIZONTALLY	AR		AS
	HYDRAULIC HITCH	AT		AU
	LOCK	AV	BW	AW
	LIGHT	AZ		BA
	BLOWER FAST	BB		BC
	ARROW (LEFT)	BD	EU	BE
	ARROW (RIGHT)	BF	EV	BG
	HYDRAULIC FLUID	BH		BJ
	WORK LIGHTS	BK		BL
	TRACTOR WITH REAR PTO	BM		BN
	READING LIGHTS	BP		BR
	5 <sup>TH</sup> GEAR LOCKOUT	BS		BT

NOTES











Legends shown represent positive lens legend, where image is stamped on lens. On negative lens legends, the background is stamped black so that only the image will be illuminated when the switch is actuated. Legend size may vary on V, L, N, and S-Series switches.

















1 Negative legends not available on L, LD, LW, and N-Series.

2 Many symbols are SAE (J1362), ANSI and ISO approved symbols. Consult factory for custom symbols/icons.

3 Use "body" legend codes for laser etched image identification.

# Legend Imprinting

LEGEND		LEGEND CODE		
SYMBOL	NAME (SYMBOL MEANING)	BODY	LENS	
			NEGATIVE <sup>1</sup>	POSITIVE
	FAILURE/ MALFUNCTION	BU		BV
COCKPIT LTS	COCKPIT LIGHTS	CB		CC
STOR LTS	STORAGE LIGHTS	CD		CE
SEAT		CF		CG
LIGHT		CH		CK
ANCHOR		CJ		CL
	POWER TAKE OFF	CR	EW	CS
STBD		CM		CN
FUEL		CP		CT
PORT		CU		CV
	SEAT BELT	CZ		DA
	ENGINE DIAGNOSTIC	DB		DC
	TRANS. OIL TEMP	DM	FG	DN
	TRANS. OIL PRESSURE	DP	FH	DR
	AIR FILTER	DS	FJ	DT
	WATER TEMP.	DU	FK	DV
	ENG. OIL PRESSURE	DW	FL	DX
	* BAR LENS LASER ETCHED	EK		

LEGEND		LEGEND CODE		
SYMBOL	NAME (SYMBOL MEANING)	BODY	LENS	
			NEGATIVE <sup>1</sup>	POSITIVE
	* * BAR LENS LASER ETCHED	EL		
DIM		FC		FD
BRIGHT		FE		FF
	REAR INTERAXLE WHEEL DIFF LOCK	FS		
	FRONT WHEEL DIFF LOCK	FT		
	CRAWLING	FU		
	HI/LO GEAR XFER BOX	FV		
	REAR INTERAXLE DIFF LOCK	FW		
	XFER BOX NEUTRAL	FX		
	SUNROOF CLOSE	FY		
	SUNROOF OPEN	FZ		
	BOGGIE LIFT SELECTOR/UP	GA		
	BOGGIE LIFT SELECTOR/DN	GB		
	REAR BUZZER INHIBIT	GC		
	EXTRA HIGH BEAM LAMP	GD		
	MIRROR HEAT	GE		
	ASR OFF ROAD	GF		
	REAR WHEEL DIFF LOCK	GG		

## NOTES

Legends shown represent positive lens legend, where image is stamped on lens. On negative lens legends, the background is stamped black so that only the image will be illuminated when the switch is actuated. Legend size may vary on V, L, N, and S-Series switches.

1 Negative legends not available on L, LD, LW, and N-Series.

2 Many symbols are SAE (J1362), ANSI and ISO approved symbols. Consult factory for custom symbols/icons.

3 Use "body" legend codes for laser etched image identification.



LEGEND		LEGEND CODE		
SYMBOL	NAME (SYMBOL MEANING)	BODY	LENS	
			NEGATIVE <sup>1</sup>	POSITIVE
	ADR SWITCH	GH		
	EQUIP LIGHT	GJ		
	PANIC ALARM	GK		
	BEACON WARNING LIGHT	GL		
	MAIN DOOR UNLOCK	GM		
	BOGGIE RATIO CTRL	GN		
	WATER IN FUEL	GP		
	REDUCED SET BURGLAR ALARM	GR		
	PTO ADD GEAR BOX	GS		
	EBS TRAILER BRAKE	GT		
	MUDDY SITE	GU		
	PTO GEAR BOX	GV		
	MAIN DOOR LOCK	GW		
	HAZARD WARNING	GX		
	HILL START AID	GY		
	DRIVING LEVEL CTRL	GZ		
	DRIVING LEVEL CTRL/2	HA		
	REAR WORK PROJ LAMP	HB		

LEGEND		LEGEND CODE		
SYMBOL	NAME (SYMBOL MEANING)	BODY	LENS	
			NEGATIVE <sup>1</sup>	POSITIVE
OFF	OFF ENG CTRL RATING/PTO	HC		
	ON/OFF PARKING HEATER	HD		
	RED INTERIOR LIGHTING	HE		
	BYPASS/PARKING HEATER	HG		
	AIR SUSPENSION DN	HJ		
	AIR SUSPENSION UP	HK		
—	ENGINE RATING CTRL-	HL		
	AUTO/MANUAL	HM		
	MEM/RECALL	HN		
AUTO	DRIVING LEVEL CTRL/AUTO	HP		
	PERM XFER BOX DIFF LOCK	HR		
	FUNCTION LAMP	HT		
	ENGINE/XFER BOX PTO	HU		
	WINDOW LIFT	HV		
	ABS INHIBIT	HW		

NOTES

Legends shown represent positive lens legend, where image is stamped on lens. On negative lens legends, the background is stamped black so that only the image will be illuminated when the switch is actuated. Legend size may vary on V, L, N, and S-Series switches.

1 Negative legends not available on L, LD, LW, and N-Series.

2 Many symbols are SAE (J1362), ANSI and ISO approved symbols. Consult factory for custom symbols/icons.

3 Use "body" legend codes for laser etched image identification.

# Legend Imprinting

LEGEND		LEGEND CODE		
SYMBOL	NAME (SYMBOL MEANING)	BODY	LENS	
			NEGATIVE <sup>1</sup>	POSITIVE
	* CONTURA IV & V BAR LENS LASER ETCHED	HX		
	* * CONTURA IV & V BAR LENS LASER ETCHED	HY		
	ENGINE RATING CTRL	HZ		
<b>ON</b>	ON ENG CTRL RATING/PTO	JA		
<b>+</b>	ENGINE RATING CTRL+	JB		
	HAZARD WARING LAMP	JC		
	ADR SWITCH	JD		
	DRIVING LEVEL CONTROL	JE		
	DRIVING LEVEL CONTROL	JF		
<b>-</b>	FUNCTION INDICATOR	JG		
	AUTO/MANUAL	JH		
	MIRROR HEAT LEFT DRIVING	JJ		
	PTO GEAR BOX	JK		
	ASR OFF ROAD/ TRACTION CTRL	JL		
	REAR WHEEL DIFF LOCK	JM		
	HSA/BSRA SWITCH	JN		
	EQUIPMENT LIGHTING	JP		
	MACHINE ON	JR		

LEGEND		LEGEND CODE		
SYMBOL	NAME (SYMBOL MEANING)	BODY	LENS	
			NEGATIVE <sup>1</sup>	POSITIVE
	PANIC ALARM	JS		
	BEACON WARNING LIGHT	JT		
	MV SUNROOF HATCH	JU		
	BOGGIE LIFT SELECTOR	JV		
	BOGGIE LIFT SELECTOR	JW		
	ACOUSTIC REVERSE LIGHT	JX		
	REAR WORK PROJECTOR LAMP	JY		
	PTO ON REAR ENGINE NMV	JZ		
	REAR INTER AXLE/ WHEEL DIFF LOCK	KA		
	WINDOW LIFT	KB		
	AIR SUSPENSION DOWN	KC		
	AIR SUSPENSION UP	KD		
	MAIN DOOR UNLOCK	KE		
	MAIN DOOR LOCK	KF		
<b>MEM</b> 	MEMORIZE/ RECALL SWITCH	KG		
<b>2s recall</b> <b>5s store</b>	MEMORIZE/ RECALL SWITCH	KH		
<b>ON</b> 	ON/OFF ENGINE RATING CTRL	KJ		
	REDUCED SET BURGLAR ALARM	KK		

## NOTES

Legends shown represent positive lens legend, where image is stamped on lens. On negative lens legends, the background is stamped black so that only the image will be illuminated when the switch is actuated. Legend size may vary on V, L, N, and S-Series switches.

1 Negative legends not available on L, LD, LW, and N-Series.

2 Many symbols are SAE (J1362), ANSI and ISO approved symbols. Consult factory for custom symbols/icons.

3 Use "body" legend codes for laser etched image identification.

LEGEND		LEGEND CODE		
SYMBOL	NAME (SYMBOL MEANING)	BODY	LENS	
			NEGATIVE <sup>1</sup>	POSITIVE
	PARKING HEATER	KL		
	PTO ADD GEAR BOX	KM		
	MUDDY SITE SWITCH	KN		
	EBS TRAILER BRAKE	KP		
	+/- POUR PMT	KR		
	+/- POUR PMT	KS		
	ADR SWITCH	KT		
	ADR SWITCH	KV		
	WINCH UP	KW		
	WINCH DOWN	KX		
	CRUISE SPEED	KY		
	CRUISE RESUME	KZ		
	CRUISE SET	LA		
	MAIN SWITCH CONTROL	LB		
	ADDITIONAL WARNING	LC		
	REAR SEARCH SPOTLIGHT	LD		
	FRONT SEARCH SPOTLIGHT	LE		
	2 TONES SIREN	LF		

LEGEND		LEGEND CODE		
SYMBOL	NAME (SYMBOL MEANING)	BODY	LENS	
			NEGATIVE <sup>1</sup>	POSITIVE
	DAY/NIGHT MODE	LG		
	OFF ROAD MODE	LH		
	ROAD MODE	LJ		
	WINDOW LIFT	LK		
	AUTO NEUTRAL MV/DV	LL		
	SUNROOF CONTROL	LM		
	BEACONS WARNING LIGHTS	LN		
	REDUCE SET ALARM	LP		
	NIGHT HEATER	LR		
	WHITE DISC	LS		
	AUTO NEUTRAL RENAULT	LT		
	OFF ROAD	LU		
	FUNCTION LIGHT	LV		
<b>ON</b>			11	
<b>OFF</b>			12	
<b>OFF</b>			13	
<b>ON</b>			14	
<b>OFF</b>			15	

NOTES

Legends shown represent positive lens legend, where image is stamped on lens. On negative lens legends, the background is stamped black so that only the image will be illuminated when the switch is actuated. Legend size may vary on V, L, N, and S-Series switches.

1 Negative legends not available on L, LD, LW, and N-Series.

2 Many symbols are SAE (J1362), ANSI and ISO approved symbols. Consult factory for custom symbols/icons.

3 Use "body" legend codes for laser etched image identification.





# ONLINE

[www.carlingtech.com](http://www.carlingtech.com)

Our extensive Web site provides in-depth, detailed information about our products and capabilities. With offices around the world, we're always ready to do business, answer questions and help our customers. Call, fax or e-mail anytime to start working with a company that's always **ON**.

## Product Catalogs

Carling also offers several catalogs, covering all of our circuit protection and control lines. This complete line of catalog information, which includes general specs, circuit and terminal drawings, form & fit drawings, and complete ordering information, is available in printed form or as downloadable PDF documents from our web site. Please visit our website at [www.carlingtech.com](http://www.carlingtech.com), or contact any one of our locations to request the following literature:

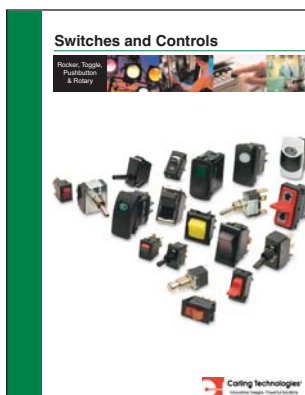

**Switches and Controls**  
This catalog includes the complete line of Carlingswitch brand electrical switches for most any power switching need. Included are rocker, toggle, pushbutton, rotary and sealed switches with a wide variety of circuits, ratings terminations, colors, illuminations, and legends. Worldwide certifications include UL, CSA, and TUV.



**Miniature Switches**  
Rounding out Carling's product portfolio is our complete line of miniature and sub-miniature switches. Offerings include sealed and unsealed rocker, toggle, pushbutton and slide switches. Various actuator styles, colors, electrical ratings and terminations are available with select UL and CUL approvals.



**Circuit Protection**  
Carling offers a full line of hydraulic/magnetic circuit breakers from the miniature M-Series to the high amperage F-Series. Various actuator styles, colors, electrical ratings and terminations are available. Worldwide certifications include UL1500, UL489A, CSA, and VDE, TUV marked.

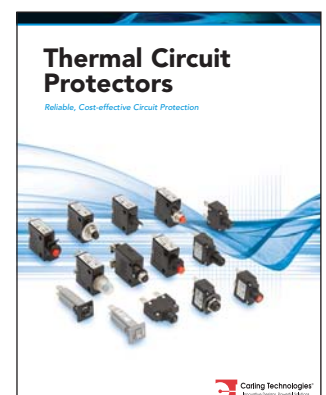

**Thermal Circuit Protectors**  
This catalog details Carling's thermal circuit protection products. Thermal protectors range from 3 to 60 amps. Bushing or Snap-in Mounting styles and Quick Connect Terminals are included. Worldwide certifications include UL1500, TUV and CE marked.





**Carling Technologies®**

Innovative Designs. Powerful Solutions.

### Worldwide Headquarters

Carling Technologies, Inc.,  
60 Johnson Avenue  
Plainville, CT 06062  
(860) 793-9281, fax: (860) 793-9231  
e-mail: [sales@carlingtech.com](mailto:sales@carlingtech.com)  
[www.carlingtech.com](http://www.carlingtech.com)

East Region Sales Office, CT  
[ersm@carlingtech.com](mailto:ersm@carlingtech.com)

Midwest Region Sales Office, IL  
[mrrsm@carlingtech.com](mailto:mrrsm@carlingtech.com)

West Region Sales Office, CA  
[wrrsm@carlingtech.com](mailto:wrrsm@carlingtech.com)

### Europe/Middle East/Africa Headquarters

Carling Technologies Ltd., Devon, England  
Int + 44 1392-364422, fax: Int + 44 1392-364477  
e-mail: [ltd.sales@carlingtech.com](mailto:ltd.sales@carlingtech.com)

GmbH, Germany  
[gmbh@carlingtech.com](mailto:gmbh@carlingtech.com)  
SAS, France  
[sas@carlingtech.com](mailto:sas@carlingtech.com)

### Asia-Pacific Headquarters

Carling Technologies, Asia-Pacific Ltd.,  
Kowloon, Hong Kong  
Int + 852-2737-2277, fax: Int + 852-2736-9332  
e-mail: [sales@carlingtech.com.hk](mailto:sales@carlingtech.com.hk)

Asia-Pacific Ltd., Shanghai, China  
[capsh@online.sh.cn](mailto:capsh@online.sh.cn)

Asia-Pacific Ltd., Japan  
[japan@carlingtech.com](mailto:japan@carlingtech.com)

Pune, India  
[india@carlingtech.com](mailto:india@carlingtech.com)

Kaohsiung, Taiwan  
[taiwan@carlingtech.com](mailto:taiwan@carlingtech.com)



**Moritz  
Aerospace**

### Moritz Aerospace, Inc

2317 Topaz Drive  
Hatfield, PA 19440  
(215) 996-9211, fax: (215) 996-0945  
e-mail: [sales@moritzaero.com](mailto:sales@moritzaero.com)  
[www.moritzaero.com](http://www.moritzaero.com)

## Maretron®

### Maretron, LLC

9014 N. 23rd Avenue  
Suite 10  
Phoenix, AZ 85021  
(602) 861-1707, fax: (602) 861-1777  
e-mail: [sales@maretron.com](mailto:sales@maretron.com)