

# TELECOM/DATACOM

Circuit Protection



CATALOG

# FOUNDED IN 1920



Since its founding, Carling Technologies has continually forged a tradition of leadership in quality and product innovation.

There are few products that Carling Technologies hasn't turned "ON" and fewer industries that haven't turned to Carling for solutions. With ISO and TS registered manufacturing facilities and technical sales offices worldwide, Carling ranks among the world's largest manufacturers of circuit breakers, switches, power distribution units, digital switching systems and electronic controls.



## SWITCHES & CONTROLS

- Rocker
- Toggle
- Pushbutton
- Rotary

## CIRCUIT PROTECTION

- Hydraulic-Magnetic
- Thermal
- GFCI / ELCI

## CUSTOM SOLUTIONS

- PDU's
- Keypads
- Control Modules

## MULTIPLEXED POWER SYSTEMS

- HMI Devices & I/O Modules
- Programmable Displays
- Data Communication Interfaces
- Electrical Systems Monitoring

## STRATEGIC MARKETS SERVED:



On/Off Highway



Marine



Telecom/Datacom



Military



Renewable Energy

## GLOBAL LOCATIONS:

Carling Technologies  
World Headquarters  
Plainville, CT, USA  
ISO9001:2008  
ISO/TS16949:2009

Maretron  
Phoenix, AZ, USA

Carling Technologies  
Brownsville, TX, USA  
ISO14001:2004  
ISO9001:2008  
ISO/TS16949:2009

Carling Technologies  
Matehuala, Mexico  
ISO14001:2004  
ISO9001:2008  
ISO/TS16949:2009

Carling Technologies  
Jupiter, FL, USA

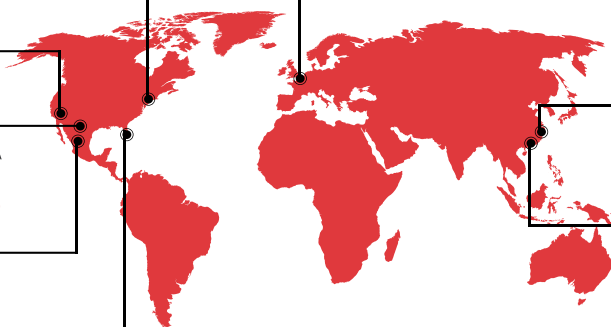

Carling Technologies  
European Headquarters  
Exeter, UK  
ISO9001:2008  
ISO/TS16949:2009

Carling Technologies  
Kowloon, Hong Kong  
ISO9001:2008  
ISO/TS16949:2009

Carling Technologies  
Zhongshan, China  
ISO14001:2004  
ISO9001:2008  
ISO/TS16949:2009

## OTHER SERVED INDUSTRIES:



Medical



Industrial Control



Audio / Visual



Commercial Food



HVAC



Floor Care



Generators



Small Appliances



Security Systems



Test & Measurement

## WORLDWIDE NUMBERS:



2000+  
EMPLOYEES



150+  
ENGINEERS

## COMPETITIVE ADVANTAGES<sup>+</sup>

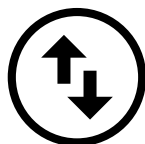

Vertical  
Integration

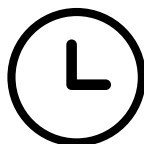

Reliable &  
On-Time Delivery



Excellent  
Customer Service



Innovative &  
Eco-Friendly Products



70+  
DISTRIBUTORS



50+  
REP FIRMS

# Telecom/Datacom

## Circuit Protection

Carling Technologies offers a full line of innovative, high-performance and reliable circuit breakers that meet all current datacom/telecom industry performance and design requirements insuring continued services and maximum circuit protection.

These circuit breakers are ideally suited for the rigors and confined spaces found in today's telecom/datacom power distribution units and rack systems. In other words, Carling circuit breakers protect against unnecessary power outages while providing design features that exceed today's expectations.

**Within This Catalog**, you will find comprehensive product information for each product series including applications, specifications and ordering schemes.

**Available Online** are tools such as part configurator, product selectors and stock checks. For the latest information on all our products, please visit [www.carlingtech.com](http://www.carlingtech.com)

**Application Solution Engineers** are readily available to assist you in selecting the appropriate product for your application. For further assistance, please email us at [custservice@carlingtech.com](mailto:custservice@carlingtech.com)

## Table of Contents





	page
Product Selector Guide.....	2
N-Series .....	4
L-Series.....	11
CX-Series.....	17
M-Series .....	25
A-Series .....	44
B-Series .....	64
TB-Series.....	81
C-Series .....	85
F-Series.....	105
Time Delay Values .....	115
Custom Power Distribution Units .....	120

Watch Market Video



	 <i>N-Series</i>	 <i>L-Series</i>	 <i>CX-Series</i>	 <i>M-Series</i>
<b>Number of Poles</b>	1-2	1-3	1-5	1-2
<b>Actuator Style</b>	flush rocker, with or without push to reset guard	rocker, with or without guard	handle, 1 per pole	<b>solid color:</b> angled rocker, paddle, baton, push-to-reset pushbutton, push-pull pushbutton <b>two color:</b> visi-rocker <b>illuminated:</b> angled rocker, flat rocker
<b>Available Delays</b>	AC: ultrashort, short, medium, long, short-high inrush, medium-high inrush, long-high inrush	AC: ultrashort, short, medium, long, short-high inrush, medium-high inrush, long-high inrush	DC: instant, ultrashort, short, medium & long	AC/DC: instantaneous, short, medium, hi-inrush
<b>Max Current &amp; Voltage Ratings</b>	1-20A@240/277VAC 1-30A@120/240VAC	.1-32A@120/240VAC .1-20A@415/240VAC, 3 pole	UL Recognized 0.2-115A@600VDC  UL Listed 0.2-15A@250/500VDC 0.2-50A@205/410VDC	<b>1 Pole:</b> 0.02-15FLA@32VDC, 125VAC 15.1-25GPA@32VDC, 125VAC 0.02-12FLA@250VAC 0.02-7.5GPA@50VDC 0.02-30GPA@65VDC, 80VDC <b>2 Pole:</b> 0.02-15FLA@65VDC, 250VAC 15.1-25GPA@65VDC, 250VAC <b>Parallel Pole:</b> 31-50GPA@80VDC
<b>Max Interrupting Capacity</b>	22,000 amps	5000 amps	UL Listed and UL Recognized up to 10,000 amps	<b>1 Pole:</b> 1,000A@32VDC 1,000A@125VAC <b>2 Pole:</b> 1,000A@65VDC 1,000A@250VAC <b>Parallel Pole:</b> 600A@80VDC
<b>Auxiliary Switch Rating</b>	n/a	n/a	20A@80VDC (GO circuit)	7A@250VAC 0.1A@125VAC (gold contacts) 7A (res.)@28VDC 4A (ind.)@28VDC 0.25A@80VDC
<b>Available Circuits</b>	series trip	series trip	series trip	series and switch only parallel pole
<b>Terminal Options</b>	screw terms	10-32, 8-32, M5 & M4 screw	10-32 or M5 screw terminals 1/4-20 or M6 threaded stud	.250" QC tabs 8-32 screw with upturned lugs 8-32, 10-32 screw (bus type) push in stud terminals
<b>Mounting Method</b>	threaded insert: #6-32 x .195 inches ISO M3 x 5mm	threaded insert: #6-32 UNC-2B, or M3X0.5-6H B ISO (2 per pole)	threaded insert: #6-32 UNC-2B, or M3X0.5-6H B ISO (2 per pole)	snap-in front panel threaded bushing
<b>Agency Approvals</b>	UL489, TUV (EN60947-2)	UL 489, cUL, TUV (EN60934-2)	UL489, UL1077, TUV (EN60934-2)	UL recognized, CSA, VDE, TUV, UL489A listed

\*Options and approvals shown may apply to specific construction combinations only, consult factory for clarification.  
 Manufacturer reserves the right to change product specifications without prior notice.

	 <i>A-Series</i>	 <i>B-Series</i>	 <i>TB-Series</i>	 <i>C-Series</i>	 <i>F-Series</i>
<b>Number of Poles</b>	1-6 (handle) 1-3 (rocker & metal toggle)	1-6	2	1-6 (handle) 1-3 (rocker & metal toggle)	1-3
<b>Actuator Style</b>	sealed metal toggle handle rocker paddle	handle rocker	handle	sealed metal toggle handle rocker	handle
<b>Available Delays</b>	<b>AC, DC, AC/DC:</b> instantaneous, ultra- short, short, medium & long  <b>AC, DC:</b> high inrush- short, medium & long	<b>AC, DC, AC/DC:</b> instantaneous, ultra- short, short, medium & long  <b>AC, DC:</b> high inrush- short, medium & long	AC, ultrashort, shot, medium, long, high inrush	<b>AC, DC, AC/DC:</b> instant, ultrashort, short, medium & long <b>AC, DC:</b> high inrush-short, medium & long	<b>AC, DC:</b> short, medium & long
<b>Max Current &amp; Voltage Ratings</b>	0.02-30A@ 277VAC, 80VDC  31.0-50A@ 125/250VAC, 65VDC	0.02-30A@ 277VAC, 80VDC  0.02-30A@ 125/250VAC, 65VDC	.1-20A@ 120/240VAC	<b>UL Listed:</b> 0.02-250A@80VDC 0.1-100A@125VDC 0.02-70A@120VAC 0.02-20A@240VAC <b>UL Recognized:</b> 0.02-30A@480WYE/277VAC 2 Pole, 1Ø; 3 Pole, 3Ø 0.02-50A@277VAC 0.02-100A@250VAC, 80VDC 0.02-100A@120V/ 240VAC, 65VDC	<b>UL489 Listed:</b> 50-250A@125VDC 100-250A@120/240VAC 100-250A@277VAC 100-250A@208Y/120, 3ØVAC  <b>UL489A Listed</b> 250-700A@125VDC
<b>Max Interrupting Capacity</b>	7500A@80VDC, UL only 3000A@120/250VAC, UL only 5000A@277VAC, with fuse backup	7500A@80 VDC, UL only 3000A@125/250VAC, UL only 5000A@277VAC, with fuse backup	5000A@ 120/240 VAC	<b>UL Listed:</b> 50000A@80VDC, 1 pole only 10000A@120VAC 5000A@125VDC/240VAC <b>UL Recognized:</b> 7500A@80VDC 3000A@125/250VAC, UL only 5000A@250VAC listed construction 5000A@480WYE/277VAC with fuse backup	50000A@125VDC 10000A@120/240, 277, 208Y/120VAC
<b>Auxiliary Switch Rating</b>	10.1A@125VAC 0.1A@125VAC (gold contacts) 0.5A@65VDC 0.1A@80VDC	10.1A@125VAC 0.1A@125VAC (gold contacts) 0.5A@65VDC 0.1A@80VDC	10.1A@125 VAC 0.1A@125 VAC (gold contacts) 0.5A@65 VDC 0.1A@80 VDC	10.1A@250VAC 0.1A@125VAC (gold contacts) 0.5A@80VDC	10.1A@250VAC 0.5A@65VDC 0.1A@80VDC
<b>Available Circuits</b>	series, shunt, relay, switch only, series with remote shutdown, relay & shunt trip dual coil	series, shunt, relay, switch only, series with remote shutdown, relay & shunt trip dual coil, mid-trip with alarm switch	series trip	series, shunt, relay, switch only, series with remote shutdown, relay & shunt trip dual coil, mid-trip with alarm switch	series & switch only with or without metering shunt
<b>Terminal Options</b>	.250" QC tabs 8-32 & 10-32 screw (& metric), PCB	.250" QC tabs, 8-32 & 10-32 screw (& metric), PCB	8/32, 10/32, M4, M5 back connector	10-32 stud, 1/4-20 stud, 10-32 screw with saddle clamp, 7/16 clip & push-in	3/8-16 stud, 3/8-16 screw & box wire connector
<b>Mounting Method</b>	threaded inserts: front panel snap-in	threaded inserts: front panel snap-in	threaded inserts	threaded inserts	rear or front panel
<b>Agency Approvals</b>	UL, CSA, VDE, TUV (rocker), UL1500, UL489A	UL, CSA, VDE, TUV (rocker), UL1500, UL489, UL489A	UL489, TUV	UL, CSA, VDE, TUV, UL1500, UL489, UL489A	cUL,TUV, UL489, UL489A

\*Options and approvals shown may apply to specific construction combinations only, consult factory for clarification.

# N-Series

## CIRCUIT BREAKER

Carling Technologies' high-performance N-Series hydraulic-magnetic circuit breaker is ideally suited for the rigors and confined spaces of telecom and datacom power distribution units and rack systems. Its innovative, low profile design features easily accessible load and line terminals and sliding barriers for effortless installation.

With the integration of an optional current transformer, the N-Series is capable of sensing current down to a level of 1%. This optional capability provides precise current monitoring and reporting required for back billing of the actual power consumed by datacenter storage and routing devices. This feature also facilitates load adjustments and maximizes efficiency.

A patent pending, flush-rocker actuator and push-to-reset guard offer additional protection against accidental switching.

1-2 poles; ratings: 1-30 amps up to 240 VAC, 277 VAC, 120/240 VAC; 22,000 Amps Max Interrupting Capacity; UL 489 Compliant Sliding Terminal Barriers; EN60947-2 Certified



### Resources:

[Download 3D CAD Files](#)

[IGS >](#)

[STP >](#)

[Watch Product Video](#)



### Product Highlights:

- ♦ 240 VAC, 277 VAC, 120/240 VAC
- ♦ UL 489 Compliant Sliding Terminal Barriers
- ♦ 22,000 Amps Max Interrupting Capacity
- ♦ 1 – 30 Amps Current Rating
- ♦ Optional Current Transformer
- ♦ EN60947-2 Certified

### Typical Applications:

- ♦ Telecom/Datacom
  - PDU's
  - Data Servers
  - Data Storage

# N-Series

## DESIGN FEATURES

### CURRENT TRANSFORMER

Remote current sensing via molex connector

### UPPER ARC RUNNER

Optional, for 277 VAC rated breakers

### GRIDS (5x)

Arc deionizing splitter plates that increase arc voltage for quick interrupt

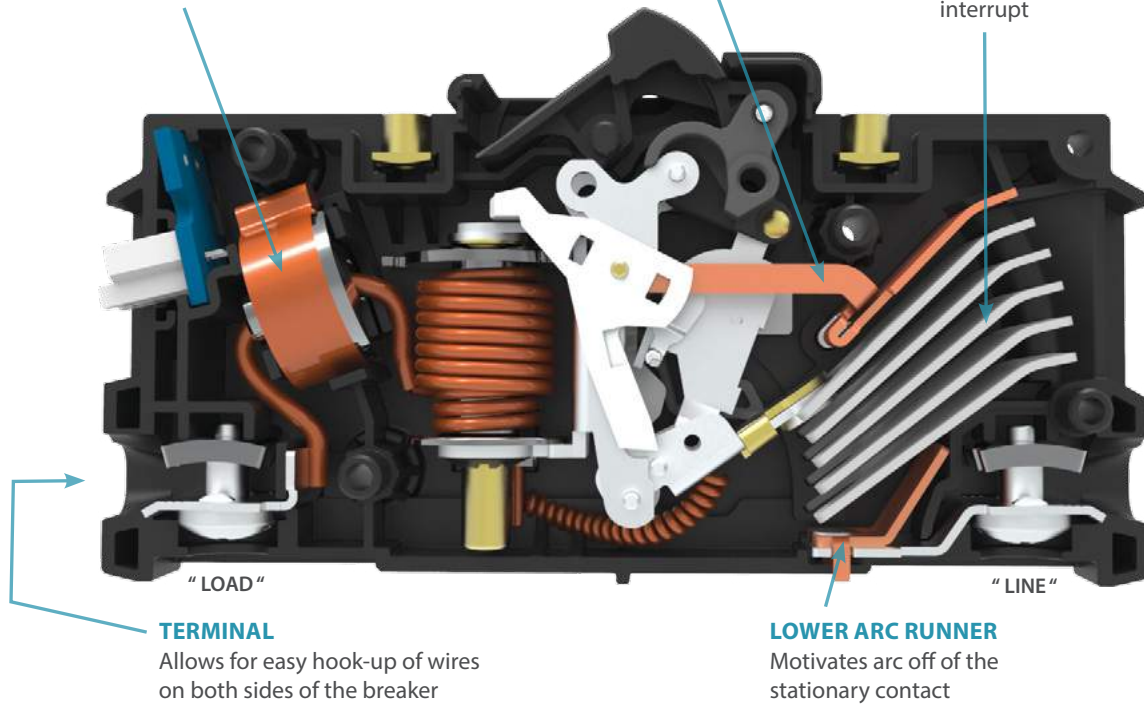

### TERMINAL

Allows for easy hook-up of wires on both sides of the breaker

### LOWER ARC RUNNER

Motivates arc off of the stationary contact

### SLIDING TERMINAL BARRIERS

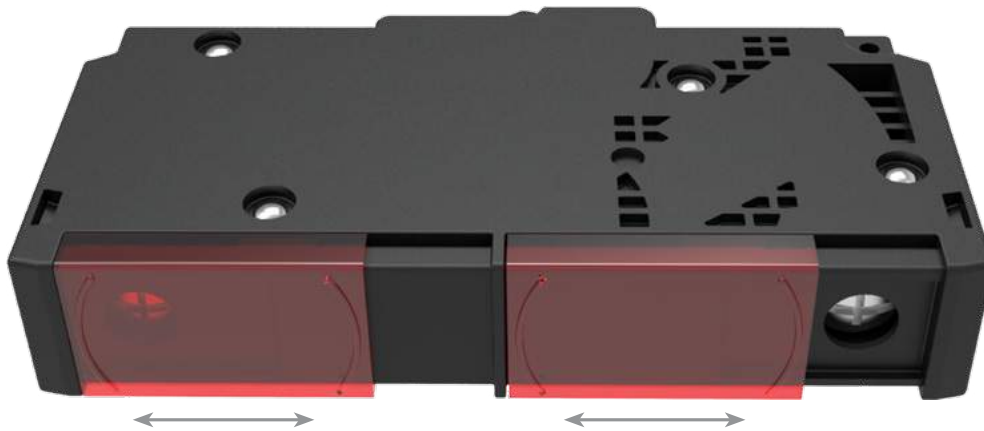

**Electrical**

**Current Metering**

Integrated current transformer.  
 Measurement range: 1-30 Amps.  
 Voltage output: 10mV per Amp according to the formula below:  
 $2(\text{Amp}) \leq I \leq 30(\text{Amp})$   
 $V = 0.01 \times I \pm 2\%$   
 (with current metering codes 1 or 2)  
 $V = 0.01 \times I \pm 1\%$   
 (with current metering codes 3 or 4)

$$\left| \frac{\frac{V - V_{10}}{I - I_{10}}}{\frac{V_{10}}{I_{10}}} \right| \leq 0.85\%$$

Where V=CT output in volts  
 $V_{10}$ =CT output in volts with  $I=I_{10}=10$  (A);  $I$ =primary current in amperage (50/60 Hz). Phase shift between primary current and CT output is  $0.25 \pm 0.25^\circ$ . Maximum crest factor of primary current is 1.73. R1 shall be integrated in the breaker. R2 and R3 are provided by end user and external to the breaker.  
 Connection: below Load Terminal.  
 2-pin connector, Molex 35362-0250.  
 Mating Connector housing – Molex PN35507-0200.  
 (Current metering is available on AC rated devices only)

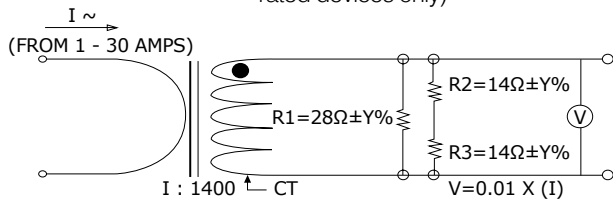

Note: When current metering code is 1 or 2; Y to equal 1.0  
 When current metering code is 3 or 4; Y to equal 0.1

**Dielectric Strength**

UL, CSA-1960V 50/60 Hz for one minute between all electrically isolated terminals. Comply with the 8mm spacing and 3750V 50/60 Hz dielectric requirements from hazardous voltage to operator accessible surfaces and between main circuits of adjacent poles per Publications EN 60950 and VDE 0805

**Impedance**

See next page

**Insulation Resistance**

Minimum of 100 Megohms @ 500VDC  
 50 operations @ 600% of rated current for AC rated devices

**Overload**

**Interrupt Capacity**

See table A

**Mechanical**

**Endurance**

10,000 "On-Off" operations @ 6 per minute; with rated current & voltage

**Trip Free**

Trips on overload even when actuator is forcibly held in the "On" position

**Trip Indication**

The operating actuator moves positively to the "Off" position when an overload causes the breaker to trip

**Environmental**

**Environmental**

MIL-PRF-55629 and MIL-STD-202G  
 -40°C to +85°C

**Operating Temperature**

**Vibration**

Withstands 0.06" excursion from 10-55 Hz and 10Gs 55-500 Hz at rated current per MIL-PRF-55629 and MIL-STD-202G, Method 204D, Test Condition A. Instantaneous and ultra-short curves tested at 90% of rated current

**Shock**

Withstands 50 Gs, 6 ms saw tooth while carrying rated current per MIL-PRF-55629 and MIL-STD-202G, Method 213B, test condition "I". Instantaneous and ultra short curves tested at 90% of rated current

**Thermal Shock**

MIL-PRF-55629 and MIL-STD-202G, Method 107G, Condition A (5-cycles at -55°C to +25°C to +85°C to +25°C)

**Moisture Resistance**

MIL-PRF-55629 and MIL-STD-202G, Method 106G, i.e., Ten 24-hour cycles at +25°C to +65°C, 80-98% RH

**Salt Spray**

Method 101, Condition A (90-95% RH @ 5% NaCl Solution, 96hrs)

**Physical**

**Number of Poles**

1 - 2 poles

**Termination**

Wire ready and touch proof wire clamp (See Figure 1). Accepts up to (2) #10 AWG wires per terminal. Designed for use with solid, stranded and flexible stranded wires, with or without ferrule or pin terminals. Also accepts straight fork and flanged fork terminals.

**Termination Torque**

15-20 in-lbs (Line & Load terminals)

**Termination Barrier**

Integral sliding barrier to comply with spacing requirements (See figure 1)

**Mounting**

Threaded Insert: #6-32 UNC-2B, or M3X0.5-6H B ISO

**Insert Termination Torque**

7-9 in-lbs

**Actuator**

Rocker, with or without guard (See figures 1, 2, and 4)

**Internal Circuit Config.**

Series Trip

**Materials**

Housing - Glass Filled Polyester  
 Rocker - Nylon  
 Line/Load Terminals - Copper Alloy;  
 Bright Acid Tin Plated

**Weight**

~107 grams (~3.76 ounces) per pole

**Standard Color**

Housing - Black  
 Rocker - Several  
 (See ordering scheme for colors)

**Agency Approvals**

UL489, cUL, TUV EN60947-2



### Electrical Tables

Table A: Voltage and Current Ratings

N-SERIES TABLE A: ELECTRICAL RATINGS								
VOLTAGE	CURRENT (AMPS)	NUMBER OF POLES	INTERRUPT CAPACITY (AMPS)					
			UL 489		EN60947-2			
			1-20 A	21-30 A	1-20 A		21-30 A	
					I <sub>cu</sub>	I <sub>cs</sub>	I <sub>cu</sub>	I <sub>cs</sub>
120/240 VAC	1 - 30	2	22000	5000	10000	5000	10000	5000
240 VAC	1 - 20	1	10000	N/A	10000	5000	5000	5000
277 VAC	1 - 20	1	10000	N/A	N/A		N/A	

### Electrical: Impedance / Resistance

RESISTANCE, IMPEDANCE VALUES  
Across Line and Load Terminals

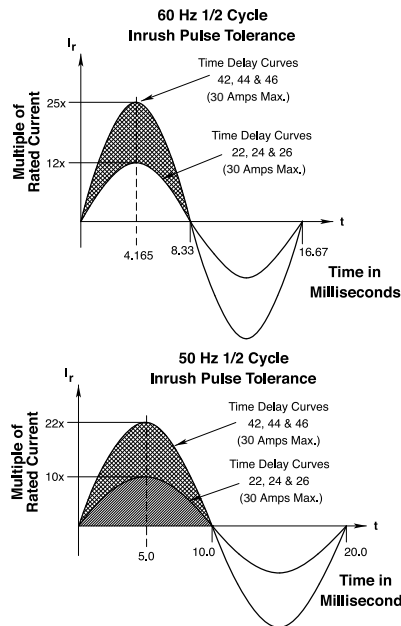
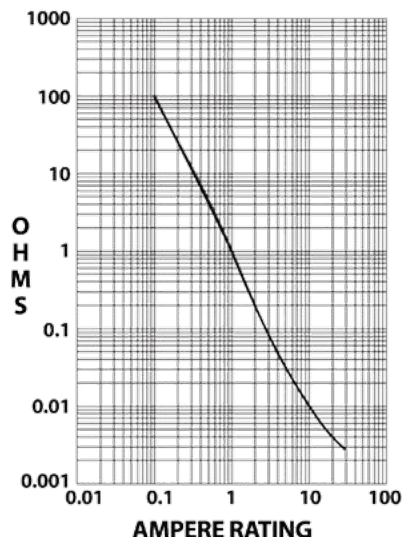

CURRENT (AMPS)	TOLERANCE (%)
0.10 - 5.0	+/- 15
5.1 - 30.0	+/- 25

\*Manufacturer reserves the right to change product specification without prior notice.

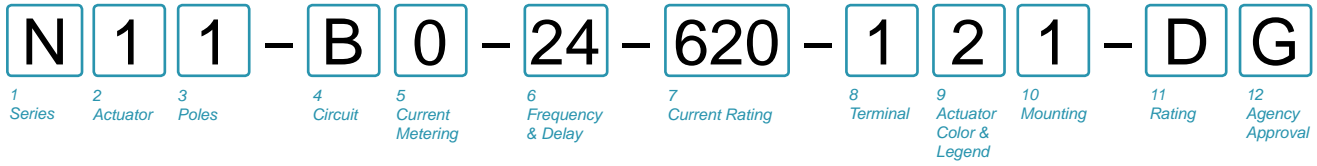

**1 SERIES**  
**N** N-Series Circuit Breaker

**2 ACTUATOR**  
**1** Single Color Low Profile Rocker, Vertical Legend  
**2** Single Color Low Profile Rocker, Horizontal Legend  
**3** Single Color Push To Reset Low Profile Rocker, Vertical Legend  
**4** Single Color Push To Reset Low Profile Rocker, Horizontal Legend

**3 POLES**  
**1** One                                    **2** Two

**4 CIRCUIT**  
**B** Series Trip (current)

**5 CURRENT METERING**  
**0** Without Current Transformer  
**1**<sup>1</sup> Integrated Current Transformer, +/- 2%, 1 per unit  
**2** Integrated Current Transformer, +/- 2%, 1 per pole  
**3**<sup>2,6</sup> Integrated Current Transformer, +/- 1%, 1 per unit  
**4**<sup>6</sup> Integrated Current Transformer, +/- 1%, 1 per pole

**6 FREQUENCY & DELAY**  
**21** 50/60 Hz Ultra Short                                    **42** 50/60 Hz Short, HI-Inrush  
**22** 50/60 Hz Short                                            **44** 50/60 Hz Medium, HI-Inrush  
**24** 50/60 Hz Medium                                        **46** 50/60 Hz Long, HI-Inrush  
**26** 50/60 Hz Long

**7 CURRENT RATING (AMPERES)**

CODE	AMPERES				
<b>410</b>	1.00	<b>440</b>	4.00	<b>490</b>	9.00
<b>512</b>	1.25	<b>445</b>	4.50	<b>495</b>	9.50
<b>415</b>	1.50	<b>450</b>	5.00	<b>610</b>	10.00
<b>517</b>	1.75	<b>455</b>	5.50	<b>710</b>	10.50
<b>420</b>	2.00	<b>460</b>	6.00	<b>611</b>	11.00
<b>522</b>	2.25	<b>465</b>	6.50	<b>711</b>	11.50
<b>425</b>	2.50	<b>470</b>	7.00	<b>612</b>	12.00
<b>527</b>	2.75	<b>475</b>	7.50	<b>712</b>	12.50
<b>430</b>	3.00	<b>480</b>	8.00	<b>613</b>	13.00
<b>435</b>	3.50	<b>485</b>	8.50	<b>614</b>	14.00
				<b>615</b>	15.00
				<b>616</b>	16.00
				<b>617</b>	17.00
				<b>618</b>	18.00
				<b>620</b>	20.00
				<b>622</b>	22.00
				<b>624</b>	24.00
				<b>625</b>	25.00
				<b>630</b>	30.00

**8 TERMINAL**  
**1** Screw Terminal

**9 ACTUATOR COLOR & LEGEND**

Actuator Color	I-O	ON-OFF	Dual	Legend Color
White	<b>A</b>	<b>B</b>	<b>1</b>	Black
Black	<b>C</b>	<b>D</b>	<b>2</b>	White
Red	<b>F</b>	<b>G</b>	<b>3</b>	White
Green	<b>H</b>	<b>J</b>	<b>4</b>	White
Blue	<b>K</b>	<b>L</b>	<b>5</b>	White
Yellow	<b>M</b>	<b>N</b>	<b>6</b>	Black
Gray	<b>P</b>	<b>Q</b>	<b>7</b>	Black
Orange	<b>R</b>	<b>S</b>	<b>8</b>	Black

**10 MOUNTING**  
**1** 6-32 x .195 inches Threaded Inserts  
**2** ISO M3 x 5 mm Threaded Inserts

**11 APPLICATION RATING**  
**C** 120/240 VAC (2 Pole only)  
**D**<sup>2</sup> 240 VAC  
**F**<sup>3</sup> 277 VAC

**12 AGENCY APPROVAL**  
**A** Without Approvals  
**G** UL 489 Listed  
**U**<sup>4</sup> TUV Certified, IEC 60947-2  
**3**<sup>5</sup> UL 489 Listed, TUV Certified

- Notes:
- 1 On multi pole units one current transformer is supplied on the actuator pole
  - 2 Available up to 20 amps
  - 3 Voltage rating F only available as a 1 pole device at 20 amps maximum
  - 4 TUV approval requires dual (I-O, ON-OFF) markings
  - 5 Approval Code "3" requires Dual (I-O, ON-OFF) markings on rocker.
  - 6 +/-1% tolerance only available when used with +/-0.1% tolerance external burden resistor.

## Dimensional Specifications: in. [mm]

Figure 1. N-Series 1-Pole Construction

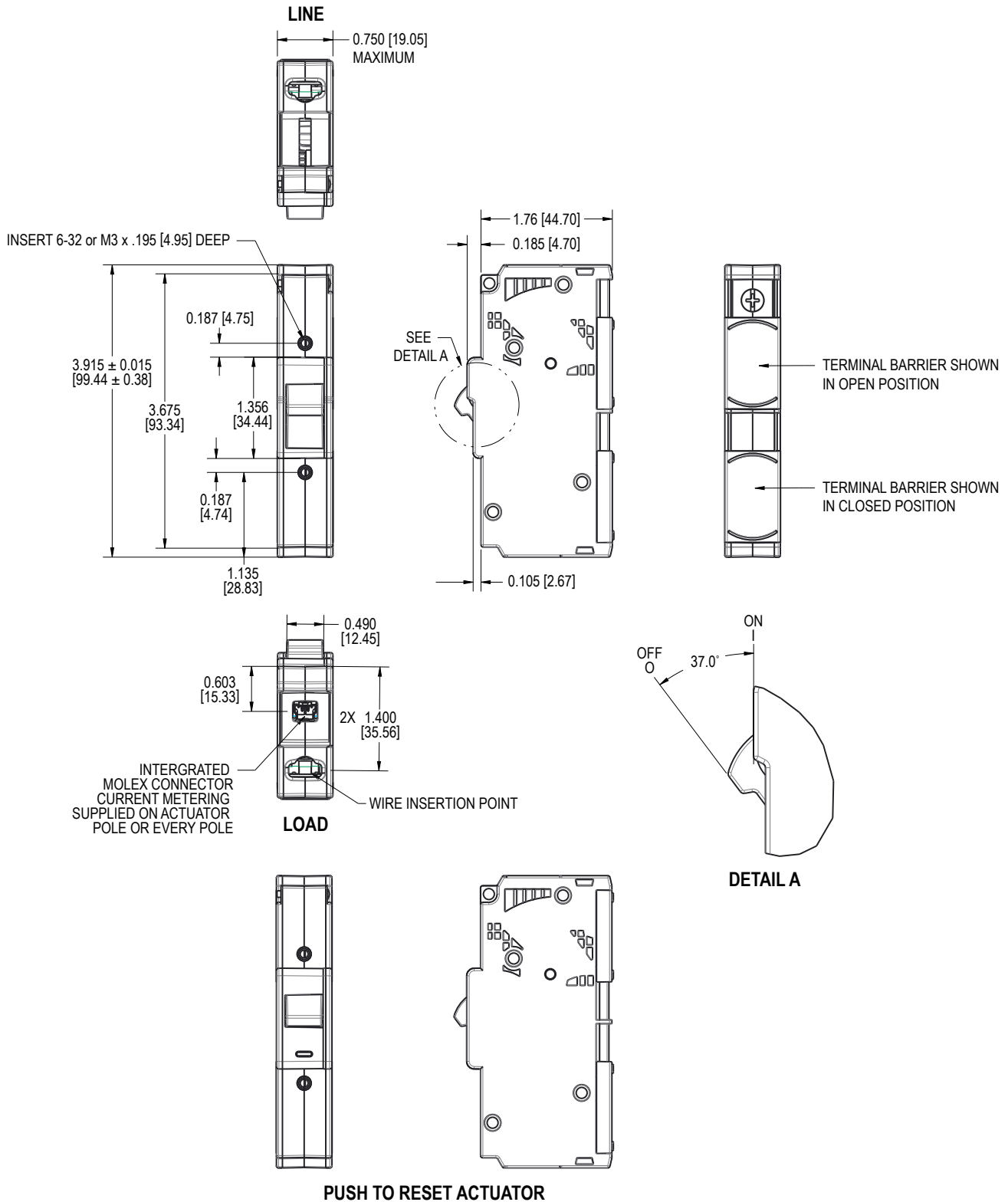

Notes:

- 1 All dimensions are in inches [millimeters].
- 2 Tolerance ±.020 [.51] unless otherwise specified.

## Dimensional Specifications: in. [mm]

**Figure 2. N-Series 2-Pole Construction**

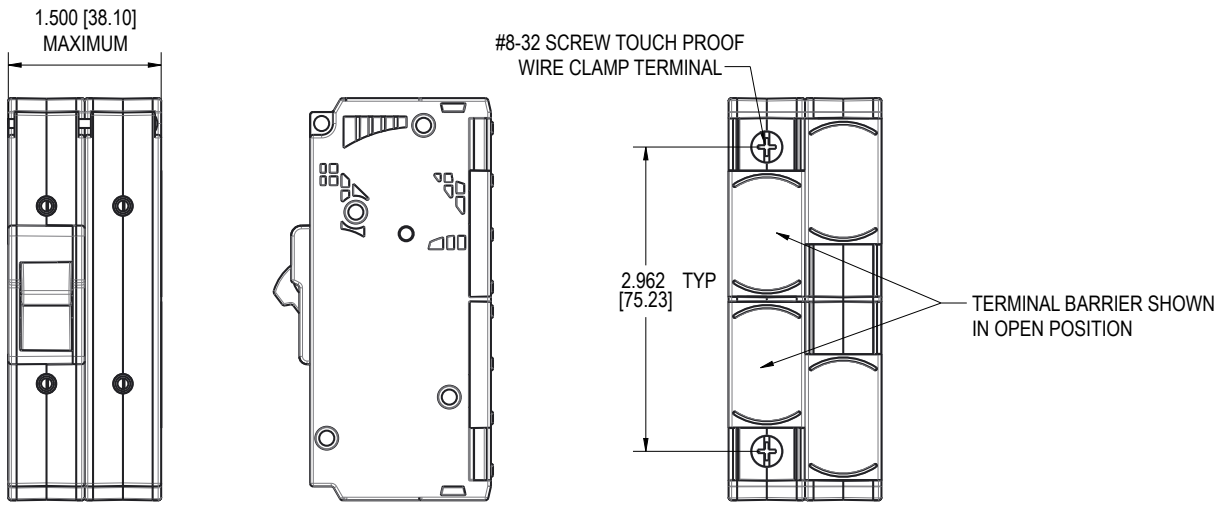

**Figure 3. Panel Cutout Details**

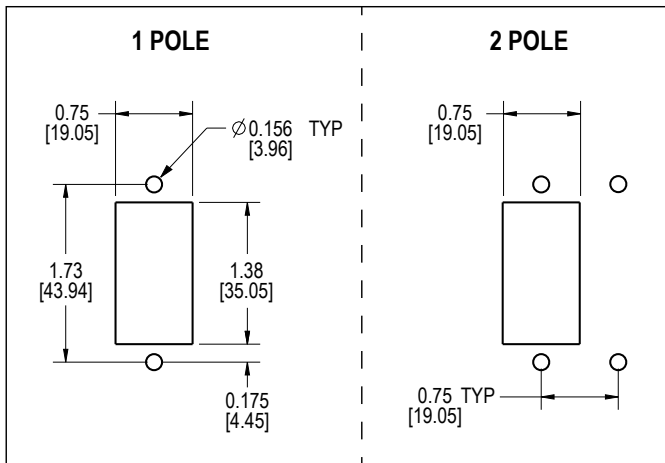

**Notes:**

- 1 All dimensions are in inches [millimeters].
- 2 Tolerance  $\pm 0.020$  [0.51] unless otherwise specified.

# L-Series

## CIRCUIT BREAKER

The L-Series high performance, compact hydraulic- magnetic circuit breaker is ideally suited for the rigors and confined spaces found in today’s telecom/datacom power distribution units and rack systems. It provides best in class performance in an innovative low profile, space saving package complementing the overall spatial objectives required by telecommunications and data-communications systems designers in their quest to reduce the overall size of equipment, while increasing transmission capacity.

With the integration of an optional current transformer, the L-Series is capable of sensing current down to a level of 1%. This optional capability provides precise current monitoring and reporting required for back billing of the actual power consumed by datacenter storage and routing devices. This feature also facilitates load adjustments and maximizes efficiency.

Further, a patent pending flush rocker actuator design and optional push-to-reset guard offers additional protection against accidental switching.

Number of poles: 1-3 poles;. Max current/voltage ratings: .1-32A, 120/240-240VAC. Max interrupting capacity: 5000 Amps



### Resources:

[Download 3D CAD Files](#)

[IGS >](#)

[STP >](#)

[Watch Product Video](#)



### Product Highlights:

- ◆ Optional current transformer
- ◆ Ultra low profile design saves valuable space
- ◆ Optional handle guard actuator
- ◆ UL 489 LISTED Branch Circuit breaker
- ◆ Designed for worldwide datacenter compatibility with up to 240VAC ratings

### Typical Applications:

- ◆ Telecom/Datacom

# L-Series

## DESIGN FEATURES

### 1-Pole Configuration with Low Profile Rocker Actuator

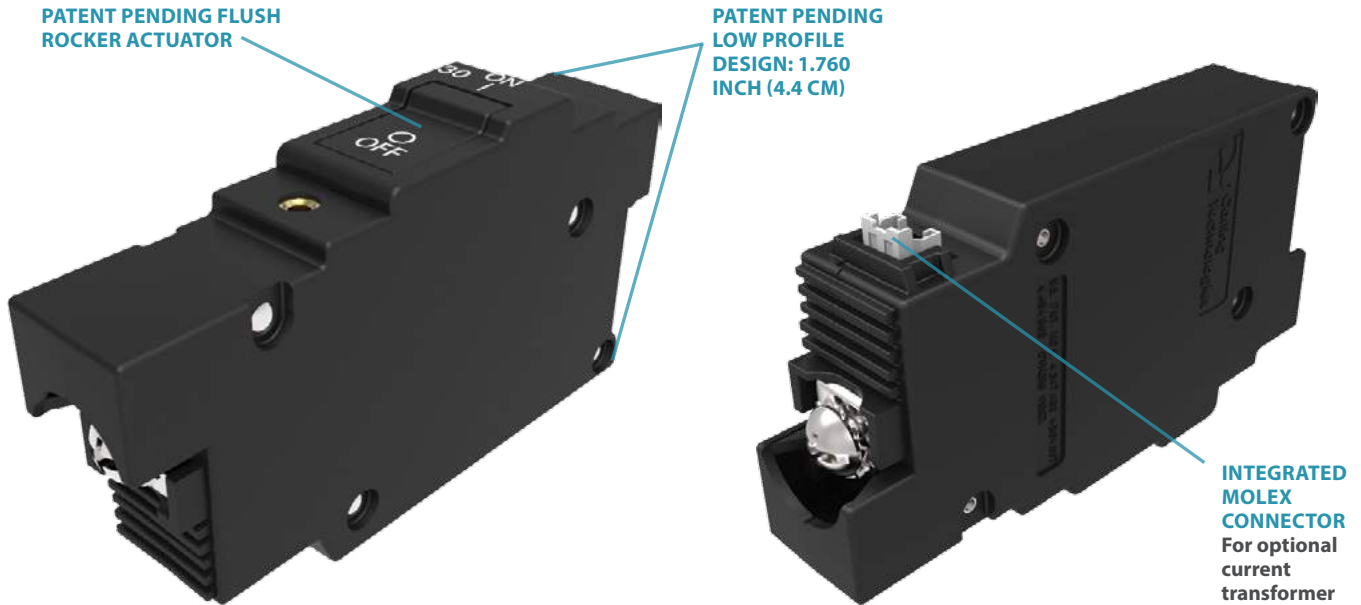

### 2-Pole Configuration with Push-To-Reset Guard



### Electrical

Maximum Voltage AC, 415Y/240VAC (see table A)  
 UL489, AC, 240VAC (see table A)

Current Metering Integrated current transformer.  
 Measurement range: 1-32 Amps  
 Voltage output: 10mV per Amp according to the formula below:  
 $2 \text{ (Amp)} \leq I \leq 32 \text{ (Amp)}$   
 $V = 0.01 \times I \pm 2\%$   
 (with current metering codes 1 or 2)  
 $V = 0.01 \times I \pm 1\%$   
 (with current metering codes 3 or 4)

$$\left| \frac{\frac{V - V_{10}}{I - I_{10}}}{\frac{V_{10}}{I_{10}}} \right| \leq 0.85\%$$

Where V=CT output in volts V<sub>10</sub>=CT output in volts with I=I<sub>10</sub>=10 (A); I=primary current in amperage (50/60 Hz). Phase shift between primary current and CT output is 0.25±0.25°. Maximum crest factor of primary current is 1.73.  
 R1 shall be integrated in the breaker. R2 and R3 are provided by end user and external to the breaker.  
 Connection: below Load Terminal.  
 2-pin connector, Molex 35362-0250.  
 Mating Connector housing – Molex PN35507-0200.

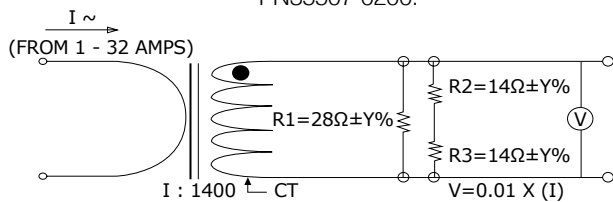

Note: When current metering code is 1 or 2; Y to equal 1.0  
 When current metering code is 3 or 4; Y to equal 0.1

Dielectric Strength UL, CSA-1960V 50/60 Hz for one minute between all electrically isolated terminals. Comply with the 8mm spacing and 3750V 50/60 Hz dielectric requirements from hazardous voltage to operator accessible surfaces and between main circuits of adjacent poles per Publications EN 60950 & VDE 0805

Impedance See next page

Insulation Resistance Minimum of 100 Megohms@500VDC

Overload 50 operations @ 600% of rated

Interrupt Capacity See Table A

### Environmental

Environmental Operating Temp MIL-PRF-55629 and MIL-STD-202G -40°C to +85 °C

Vibration Withstands 0.06" excursion from 10-55 Hz and 10Gs 55-500 Hz at rated current per MIL-PRF-55629 and MIL-STD-202G, Method 204D, Test Condition A. Instantaneous and ultra-short curves tested at 90% of rated current.

Shock Withstands 100 Gs, 6 ms saw tooth while carrying rated current per MIL-PRF-55629 and MIL-STD-202G, Method 213B, Test Condition "I". Instantaneous and ultra short curves tested at 90% of rated current.

Thermal Shock MIL-PRF-55629 and MIL-STD-202G, Method 107G, Condition A (5-cycles at -55°C to +25°C to +85°C to +25°C).

Moisture Resistance MIL-PRF-55629 and MIL-STD-202G, Method 106G, i.e., Ten 24-hour cycles at +25°C to +65°C, 80-98% RH.

Salt Spray Method 101, Condition A (90-95% RH @ 5% NaCl Solution, 96hrs)

### Physical

Number of Poles 1-3 poles

Termination Screw Terminals with the following thread sizes: 10-32, 8-32, M5, M4 Standard for 2 & 3 poles  
 Termination Barrier Threaded Insert: #6-32 UNC-2B, or M3X0.5-6H B ISO (2 per Pole)

Mounting Rocker, with or without guard

Actuator Series Trip

Internal Circuit Config. Housing - Glass Filled Polyester

Materials Rocker – Nylon 6/6  
 Line/Load Terminals – Copper Alloy;  
 Bright Acid Tin Plated  
 ~107 Grams (~3.76 Ounces) per pole  
 Housing - Black  
 Rocker - Black

### Mechanical

Endurance 10,000 "On-Off" Operations @ 6 per minute; with rated Current & Voltage.

Trip Free Trips on overload even when actuator is forcibly held in the "On" position.

Trip Indication The operating actuator moves positively to the "Off" position when an overload causes the breaker to trip

### Agency Approvals

UL489, cUL, TUV (EN60934)

\*Manufacturer reserves the right to change product specification without prior notice.

**Electrical Tables**

**Table A:** Voltage, Current and IC Ratings

L-SERIES TABLE A: VOLTAGE, CURRENT AND AIC RATINGS							
VOLTAGE	CURRENT (AMPS)	NUMBER OF POLES	PHASE	CURRENT METERING	INTERRUPT CAPACITY (AMPS)		
					UL 489 (Amps)	EN60934	
						Icn	Inc
240 VAC	0.1 - 32	1	1	Yes	5000	3000	10000
240 VAC	0.1 - 32	2*	1	Yes	5000	3000	10000
240 VAC	0.1 - 20	3	3	Yes	5000	3000	5000
415/240 VAC	0.1 - 20	3	3	Yes	---	3000	5000
120/240 VAC	0.1 - 32	2	1	Yes	5000	N/A	N/A
120/240 VAC	0.1 - 32	3**	1	Yes	5000	N/A	N/A

Notes:

\* Breaking both sides of the line

\*\* 3<sup>rd</sup> pole to be neutral break

**Electrical:** Impedance (Across circuit breaker main terminals)

RESISTANCE, IMPEDANCE VALUES  
from Line to Load Terminals

(Values Based on Series Trip Circuit Breaker)

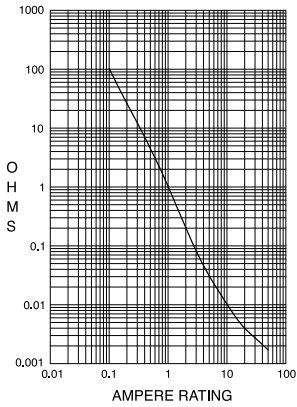

CURRENT (AMPS)	TOLERANCE (%)
0.10 - 5.0	+/- 15
5.1 - 32.0	+/- 25





**1 SERIES**  
L

**2 ACTUATOR**  
 1 Single Color Low Profile Rocker, Vertical Legend  
 2 Single Color Low Profile Rocker, Horizontal Legend  
 3 Single Color Push to Reset Low Profile Rocker, Vertical Legend  
 4 Single Color Push to Reset Low Profile Rocker, Horizontal Legend

**3 POLES**  
 1 One  
 2 Two  
 3 Three

**4 CIRCUIT**  
B Series Trip (current)

**5 CURRENT METERING**  
 0 Without Current Transformer  
 1<sup>2</sup> Integrated Current Transformer, +/- 2%, 1 per unit  
 2 Integrated Current Transformer, +/- 2%, 1 per pole  
 3<sup>2,6</sup> Integrated Current Transformer, +/- 1%, 1 per unit  
 4<sup>6</sup> Integrated Current Transformer, +/- 1%, 1 per pole

**6 FREQUENCY & DELAY**  
 20<sup>5</sup> 50/60Hz Instantaneous  
 21 50/60Hz Ultra Short  
 22 50/60Hz Short  
 24 50/60Hz Medium  
 26 50/60Hz Long  
 42 50/60Hz Short, Hi-Inrush  
 44 50/60Hz Medium, Hi-Inrush  
 46 50/60Hz Long, Hi-Inrush

**7 CURRENT RATING (AMPERES)**

CODE	AMPERES				
410	1.000	460	6.000	613	13.000
512	1.250	465	6.500	614	14.000
415	1.500	470	7.000	615	15.000
517	1.750	475	7.500	616	16.000
420	2.000	480	8.000	617	17.000
522	2.250	485	8.500	618	18.000
425	2.500	490	9.000	620	20.000
527	2.750	495	9.500	622	22.000
430	3.000	610	10.000	624	24.000
435	3.500	710	10.500	625	25.000
440	4.000	611	11.000	630	30.000
445	4.500	711	11.500	632	32.000
450	5.000	612	12.000		
455	5.500	712	12.500		

**8 TERMINAL**  
 2 Screw Terminal, 8-32 (Bus Type)  
 4 Screw Terminal, 10-32 (Bus Type)  
 E Screw Terminal, M4 (Bus Type)  
 H Screw Terminal, M5 (Bus Type)

**9 ACTUATOR COLOR & LEGEND**

Actuator Color	I-O	ON-OFF	Dual	Legend Color
White	A	B	1	Black
Black	C	D	2	White
Red	F	G	3	White
Green	H	J	4	White
Blue	K	L	5	White
Yellow	M	N	6	Black
Gray	P	Q	7	Black
Orange	R	S	8	Black

**10 MOUNTING INSERTS<sup>3</sup>**  
 1 6-32 X .195 Threaded Inserts  
 A 6-32 X .195 Threaded Inserts with Terminal Barrier  
 2 ISO M3 X 5 mm Threaded Inserts  
 B ISO M3 X 5 mm Threaded Inserts with Terminal Barrier

**11 MAX. APPLICATION RATING**  
 C<sup>1</sup> 120/240 VAC (2 or 3 Pole only)  
 D 240 VAC  
 P<sup>4</sup> 415Y/240 VAC (TUV only) 240 VAC 3 phase Delta

**12 AGENCY APPROVAL**  
 A Without approvals  
 G UL 489 Listed  
 3 UL 489 Listed, TUV Certified

Notes:

- 1 3 Pole units available only when one of three poles is neutral
- 2 On Multi Pole units one current transformer is supplied on the actuator pole
- 3 Terminal barriers are required on multi poles breaker
- 4 Voltage rating P only available as a 3 pole device 20A max
- 5 Only available with approval code "A"
- 6 +/-1% tolerance only available when used with +/-0.1% tolerance external burden resistor.

## Dimensional Specifications: in. [mm]

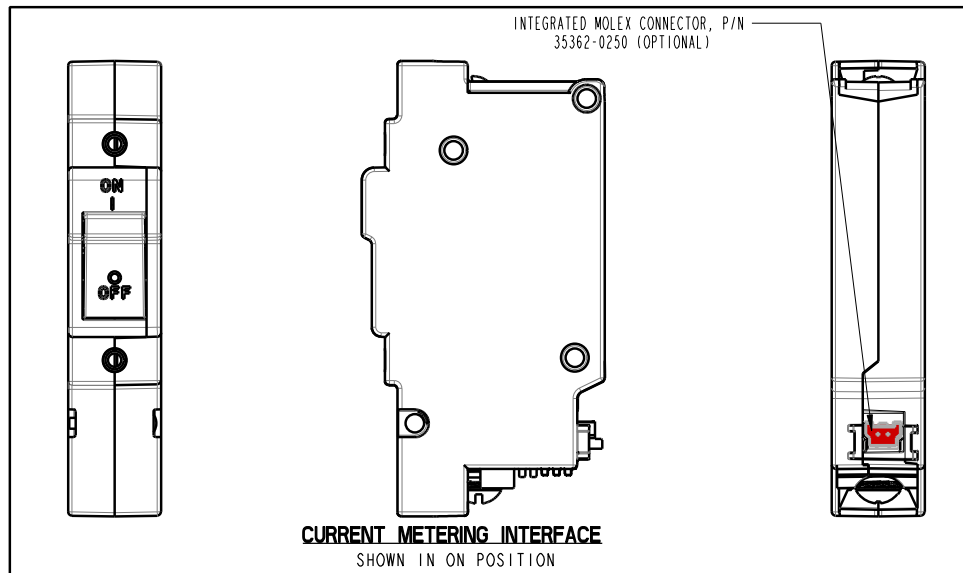
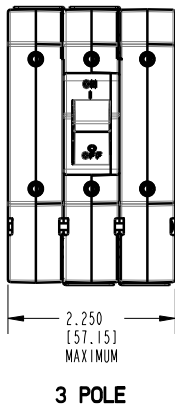
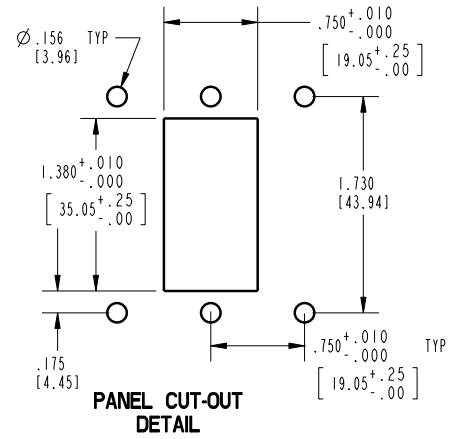
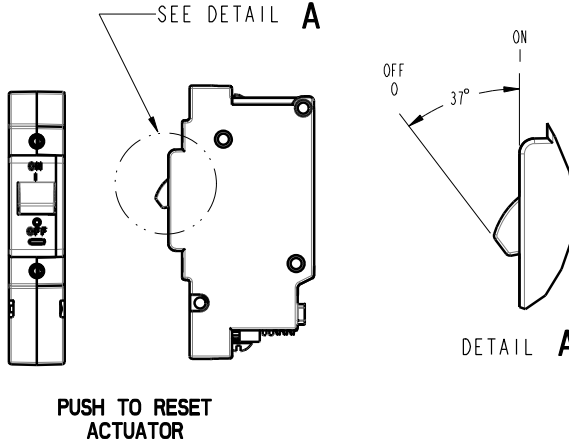
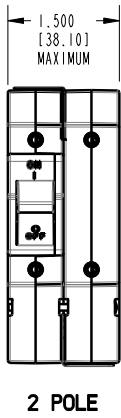
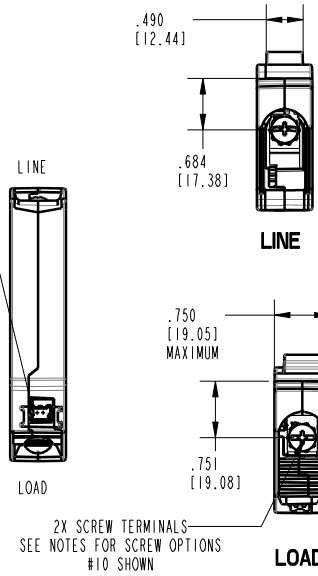
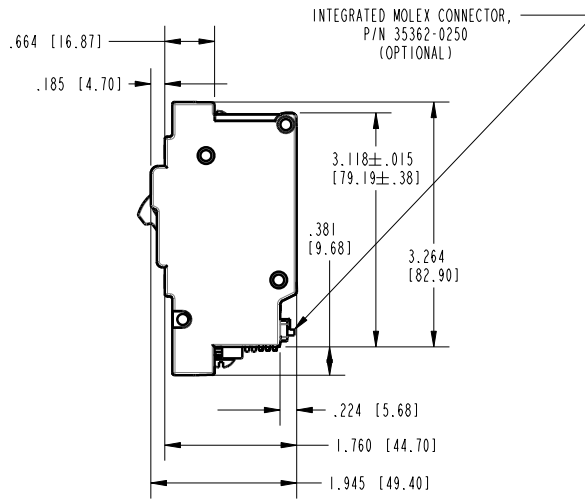
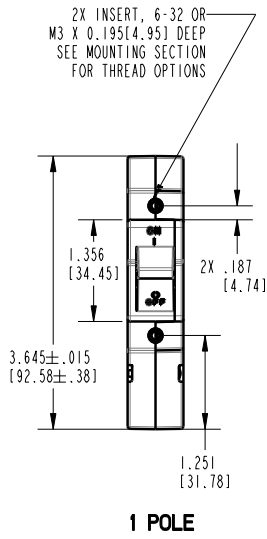

- Notes:
- 1 All dimensions are in inches [millimeters].
  - 2 Screws have combination head
  - 3 Screw thread options: #8-32, #10-32, M4X.7, M5X.8

# CX-Series

## CIRCUIT BREAKER

The CX-Series circuit breaker features a unique and innovative arc-quenching configuration that allows the breaker to safely handle high amperage and high DC voltage applications in a compact package. By using a patent pending magnetic flux boosting terminal configuration, a strong magnetic field is created thus motivating the arc into an enhanced arc chamber improving the breaker's overall performance and reliability. The permanent magnets located at the entrance of the arc chamber combined with the upper and lower arc runner increase the magnetic blow out force and aid in motivating the arc off of the contacts and into the arc chamber. An enhanced arc chamber features arc splitter retainers with integrated pressurizing walls, which facilitates heat transfer from the arc thereby providing additional cooling and quick transition into the magnetically induced splitter plates. In turn, the twelve (12) splitter plates attract, segment and cool the arc for full extinction. Combined, these innovative features make the CX-Series breaker the best in class, providing stable performance even in the most demanding applications.



### Resources:

[Download 3D CAD Files](#)

[IGS >](#)

[STP >](#)

[Watch Product Video](#)



### Product Highlights:

- UL 489 & UL 489B Listed
- TUV Certified IEC/EN 60947-2
- Temperature stable hydraulic-magnetic overcurrent sensing technology
- Optional relay trip circuit permitting remote operator system shut down
- Perfect fit for 380VDC Applications

Only Telecom-Datacom applicable ordering schemes and drawings are shown in this catalog. For complete product details, please visit [www.carlingtech.com](http://www.carlingtech.com)

# CX-Series

## DESIGN FEATURES

**HYDRAULIC/MAGNETIC SENSING COIL**

**UPPER ARC RUNNER**

Aids in motivating arc off of movable contact and into arc chamber

**MAGNETS**

**ARC SPLITTER RETAINER**

with integrated pressurizing walls

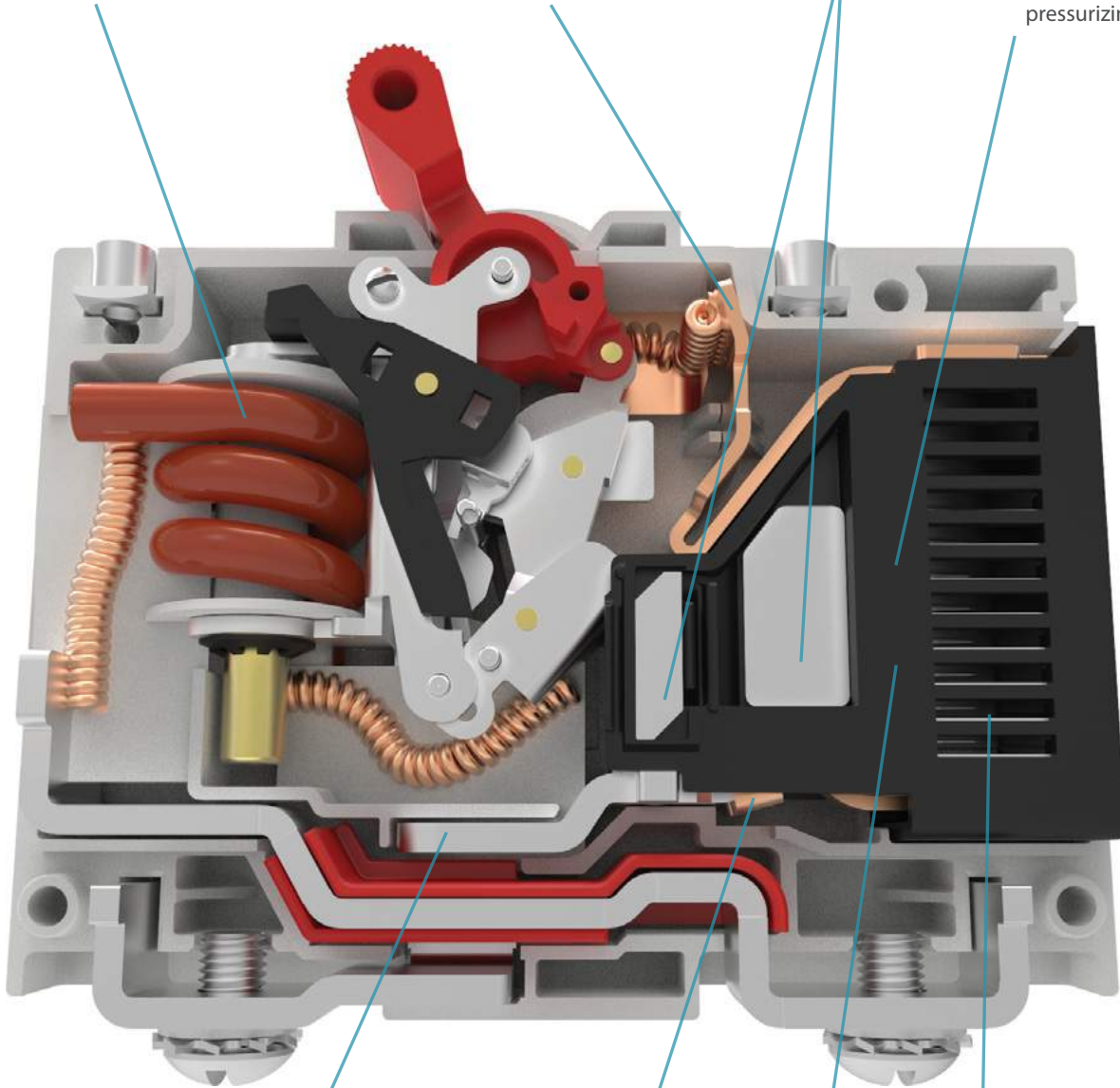

**PATENT PENDING MAGNETIC FLUX BOOSTING TERMINAL CONFIGURATION**

Design enhances motivation of arc into arc chamber

**LOWER ARC RUNNER**

Aids in motivating arc off of stationary contact and into arc chamber

**LARGE ARC GAP**

To generate high arc voltages

**(12) ARC DEIONIZING SPLITTER PLATES**

## Electrical Tables

**Table A:** Lists UL Listed (UL489) configuration and performance capabilities as a Molded Case Circuit Breaker

CX SERIES TABLE A : UL489 LISTED BRANCH CIRCUIT BREAKERS					
CIRCUIT CONFIGURATION	VOLTAGE		MAX CURRENT RATING AMPS	INTERRUPTING CAPACITY (AMPS)	NUMBER OF POLES
	MAX. RATING	FREQUENCY			
SERIES	250	D.C.	15	5,000	1
	250 / 500	D.C.	15	10,000	2
	410 / 205	D.C.	50	10,000	2

**Table B:** Lists UL Recognized configurations and performance capabilities as a Component Supplementary Protector

CX SERIES TABLE B : UL1077 COMPONENT SUPPLEMENTARY PROTECTOR						
CIRCUIT CONFIGURATION	VOLTAGE		MAX CURRENT RATING AMPS	INTERRUPTING CAPACITY (AMPS)	NUMBER OF POLES	APPLICATION CODE
	MAX. RATING	FREQUENCY				
SERIES	300	D.C.	1 - 75	5,000	1	TC1, OL0, U3
	300	D.C.	76 - 125	3,000	1	TC1, OL0, U3
	440	D.C.	1 - 30	10,000	2	TC1, OL0, U3
	440	D.C.	31 - 63	5,000	2	TC1, OL0, U3
	600	D.C.	1 - 75	5,000	2	TC1, OL0, U3
	600	D.C.	76 - 115	3,000	2	TC1, OL0, U3
SWITCH ONLY <sup>1</sup>	600	D.C.	1 - 115	----	2 or 3	---

Notes:

- 1 Requires inclusion of a relay trip voltage coil

**Table C:** Lists UL Listed (UL489B) configuration and performance capabilities as a Molded Case Switch

CX SERIES TABLE C : UL489B LISTED PHOTOVATIC MOLDED CASE SWITCH						
CIRCUIT CONFIGURATION	VOLTAGE			CURRENT RATING (AMPS)	INTERRUPTING RATING (AMPS)	CONSTRUCTION NOTES
	MAX RATING	FREQUENCY	POLES			
SERIES	600	DC	2 <sup>1</sup>	50 - 100	600	May have a third pole that is a voltage trip pole
	600	DC	4 <sup>2</sup>	110 - 175	600	May have a fifth pole that is a voltage trip pole

Notes:

- 1 Two poles in series.  
2 Two poles in series in parallel with 2 poles in series.

**Table D:** TUV Certified Configuration to IEC / EN 60947-2. Low Voltage Switch gear and Control gear - Circuit Breakers

CX-SERIES TABLE D : TUV IEC/EN 60947-2 LOW VOLTAGE SWITCH GEAR & CONTROL GEAR / CIRCUIT BREAKER					
CIRCUIT CONFIGURATION	VOLTAGE			CURRENT RATING (AMPS)	INTERRUPTING CAPACITY
	MAX. RATING	FREQUENCY	POLES		ICS / ICU (AMPS)
SERIES	440	DC	2	1-63	4,000

\*Manufacturer reserves the right to change product specification without prior notice.

## Electrical

Maximum Voltage  
Overload

600 VDC  
50 operations at 600% of rated current for UL489, and at 150% of rated current for UL1077.

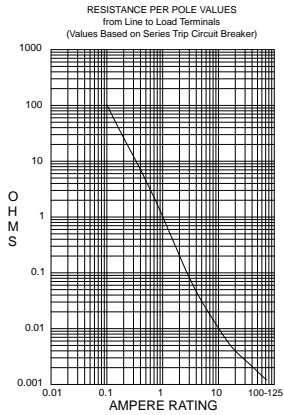

CURRENT (AMPS)	TOLERANCE (%)
0.10 - 5.0	15
5.1 - 20.0	25
20.1 - 50.0	35

## Physical

Number of Poles  
Termination  
Terminals  
Termination Barrier  
Mounting  
Actuator  
Internal Circuit Config.  
Materials

1- 2 poles, + Auxiliary Switch Pole.  
10-32 or M5 Screw Terminals  
1/4-20 or M6 Threaded Stud  
Standard with multi-pole constructions  
Threaded insert: #6-32 UNC-2B, or M3X0.5-6H B ISO (2 per pole)  
Handle, 1 per pole.  
Series Trip  
Housing - Glass filled Polyester  
Handle - Glass filled Polyester  
Line/Load Terminals - Copper Alloy.  
~150 Grams (~5.3 Ounces).  
~150 Grams (~5.3 Ounces).  
Housing - Gray.  
Handle - White, Black, Red, Green, Blue, Yellow, Gray,

Weight  
Standard Color

## Mechanical

Endurance  
Trip Free  
Trip Indication

Max 10,000 ON-OFF operations @ 6 per minute; 6000 with rated current & voltage, and 4,000 cycles mechanical.  
Trips on overload even when actuator is forcibly held in the "On" position.  
The operating handle moves positively to the "Off" position when an overload causes the breaker to trip.

## Environmental

Shock  
Vibration  
Moisture Resistance  
Salt Spray  
Thermal Shock  
Operating Temperature

Withstands 100 Gs, 6ms saw tooth while carrying rated current per MIL-PRF-55629 and MIL-STD-202G, Method 213G, Test Condition "I". Instantaneous and ultra short curves tested at 90% of rated current  
Withstands 0.060" excursion from 10-55 Hz & 10 Gs 55-500 Hz, at rated current per MIL-PRF-55629 and MILSTD-202G, Method 240D, Test Cond. A. Instantaneous & ultrashort curves tested at 90% of rated current.  
MIL-PRF-55629 and MIL-STD-202G, Method 106G, i.e., Ten 24-hour cycles at +25°C to +65°C, 80-98% RH.  
Method 101, Condition A (90-95% RH at 5% NaCl Solution, 96 hrs).  
MIL-PRF-55629 and MIL-STD-202G, Method 107G, Condition A (5-cycles at -55°C to +25°C to +85°C to +25°C).  
-40°C to +85°C.

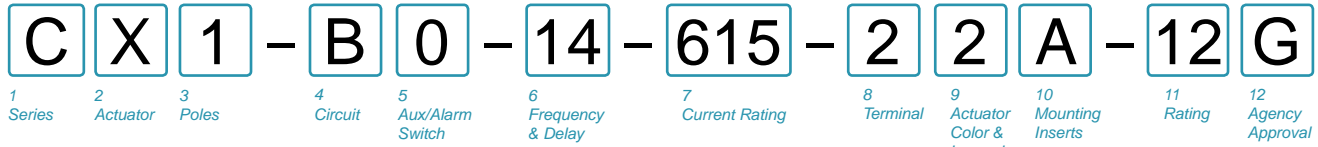

**1 SERIES**  
C

**2 ACTUATOR**  
X Handle, one per pole

**3 POLES**  
1 One  
2 Two

**4 CIRCUIT**  
B Series Trip (current)

**5 AUXILIARY/ALARM SWITCH**  
0 Without Aux Switch

**6 FREQUENCY & DELAY**  
11 DC Ultra Short  
12 DC Short  
14 DC Medium  
16 DC Long

**7 CURRENT RATING (AMPERES)**

CODE	AMPERES				
220	0.20	295	0.95	460	6.00
225	0.25	410	1.00	465	6.50
230	0.30	512	1.25	470	7.00
235	0.35	415	1.50	475	7.50
240	0.40	517	1.75	480	8.00
245	0.45	420	2.00	485	8.50
250	0.50	522	2.25	490	9.00
255	0.55	425	2.50	495	9.50
260	0.60	527	2.75	610	10.00
265	0.65	430	3.00	710	10.50
270	0.70	435	3.50	611	11.00
275	0.75	440	4.00	711	11.50
280	0.80	445	4.50	612	12.00
285	0.85	450	5.00	712	12.50
290	0.90	455	5.50	613	13.00

**8 TERMINAL**  
2 Screw Terminal, 10-32  
3 Stud, 1/4-20  
5 Screw Terminal, M5  
6 Stud, M6

**9 ACTUATOR COLOR & LEGEND**

Actuator Color	I-O	ON-OFF	Dual	Legend Color
White	A	B	1	Black
Black	C	D	2	White
Red	F	G	3	White
Green	H	J	4	White
Blue	K	L	5	White
Yellow	M	N	6	Black
Gray	P	Q	7	Black
Orange	R	S	8	Black

**10 MOUNTING INSERTS**  
A 6-32 Thread  
B M3 Thread

**11 MAX. APPLICATION RATING**  
12 250 VDC  
13 250/500 VDC <sup>1</sup>  
15 205/410 VDC

**12 AGENCY APPROVAL**  
A Without Approvals  
G UL 489 Listed  
S UL 489 Listed, TUV to IEC60947-2 <sup>1</sup>

Notes:  
<sup>1</sup> Only Available with 250/500 VDC up to 15 amps.

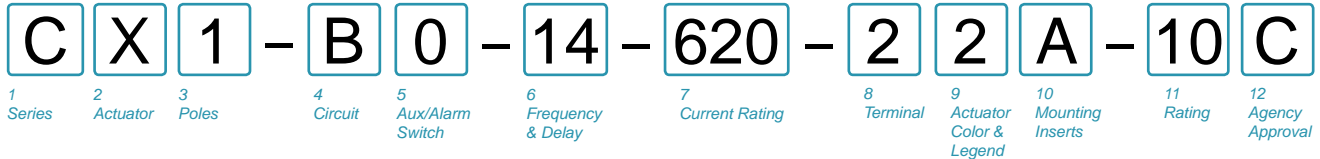

**1 SERIES**  
C

**2 ACTUATOR**  
X Handle, one per pole

**3 POLES<sup>7</sup>**  
1 One  
2 Two  
3 Three  
4 Four<sup>10</sup>

**4 CIRCUIT**  
A Switch Only (no coil)<sup>1, 9</sup>  
B Series Trip (current)  
G Relay Trip (voltage)<sup>1, 2, 3, 9</sup>

**5 AUXILIARY SWITCH**  
0 Without Aux Switch

**6 FREQUENCY & DELAY**  
03 DC 50/60Hz, Switch Only  
10 DC Instantaneous  
11 DC Ultra Short  
12 DC Short  
14 DC Medium  
16 DC Long

**7 CURRENT RATING (AMPERES)<sup>6</sup>**

CODE	AMPERES				
220	0.200	415	1.500	490	9.000
225	0.250	517	1.750	495	9.500
230	0.300	420	2.000	610	10.000
235	0.350	522	2.250	710	10.500
240	0.400	425	2.500	611	11.000
245	0.450	527	2.750	711	11.500
250	0.500	430	3.000	612	12.000
255	0.550	435	3.500	712	12.500
260	0.600	440	4.000	613	13.000
265	0.650	445	4.500	614	14.000
270	0.700	450	5.000	615	15.000
275	0.750	455	5.500	616	16.000
280	0.800	460	6.000	617	17.000
285	0.850	465	6.500	618	18.000
290	0.900	470	7.000	620	20.000
295	0.950	475	7.500	622	22.000
410	1.000	480	8.000	624	24.000
512	1.250	485	8.500	625	25.000

**8 TERMINAL<sup>8</sup>**  
2 Screw, 10-32  
3 Stud, 1/4-20  
5 Screw, M5  
6 Stud, M6

**9 ACTUATOR COLOR & LEGEND**

Actuator Color	I-O	ON-OFF	Dual	Legend Color
White	A	B	1	Black
Black	C	D	2	White
Red	F	G	3	White
Green	H	J	4	White
Blue	K	L	5	White
Yellow	M	N	6	Black
Gray	P	Q	7	Black
Orange	R	S	8	Black

**10 MOUNTING INSERTS**  
A 6-32 Thread  
B M3 Thread

**11 MAX. APPLICATION RATING**  
10 300VDC  
11 440 VDC without factory installed terminal bus<sup>4</sup>  
14 440VDC with factory installed terminal bus<sup>4</sup>  
06 600VDC<sup>5</sup>

**12 AGENCY APPROVAL**  
A Without Approvals  
C UL 1077 Recognized  
W UL 1077 Recognized & TUV Certified IEC/ EN 60947-2<sup>9</sup>

- Notes:
- 1 Only available when tied to a protected pole  
Requires special P/N consult factory for details
  - 2 Voltage trip circuit coil not rated for continuous duty - use instantaneous delay code 10
  - 3 Contacts Rated for 20A @ 80 VDC
  - 4 440VDC Rating available in two different wiring configurations.  
(see next page for more details)
  - 5 600 VDC only available with factory installed terminal bus (see next page for more details)
  - 6 Single pole units available up to 125A, multi pole units limited to 115A Max.  
(see next page for more details)
  - 7 3 Pole units must include one Auxiliary switch pole (circuit code A or G) - Requires Special Part Number. (see next page for more details)
  - 8 Screw Terminals are limited to 50A max.
  - 9 Agency approval code W only available with 440 VDC rating & circuit code B.
  - 10 4 Pole 600 VDC units only available up to 75A Max. (see next page for more details)



## Dimensional Specifications: in. [mm]

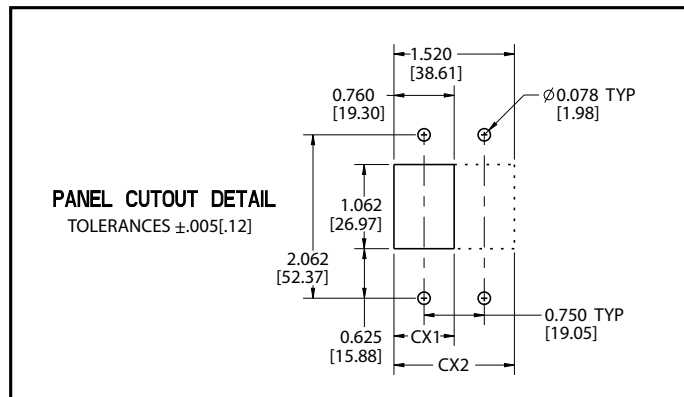
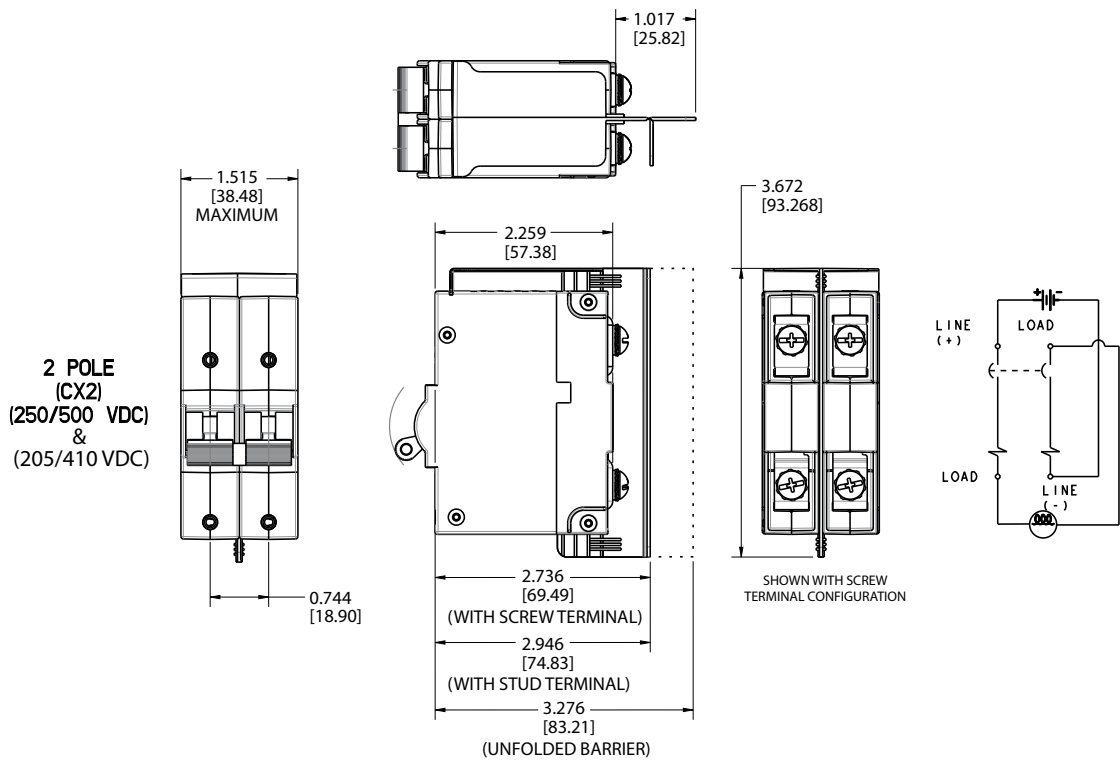
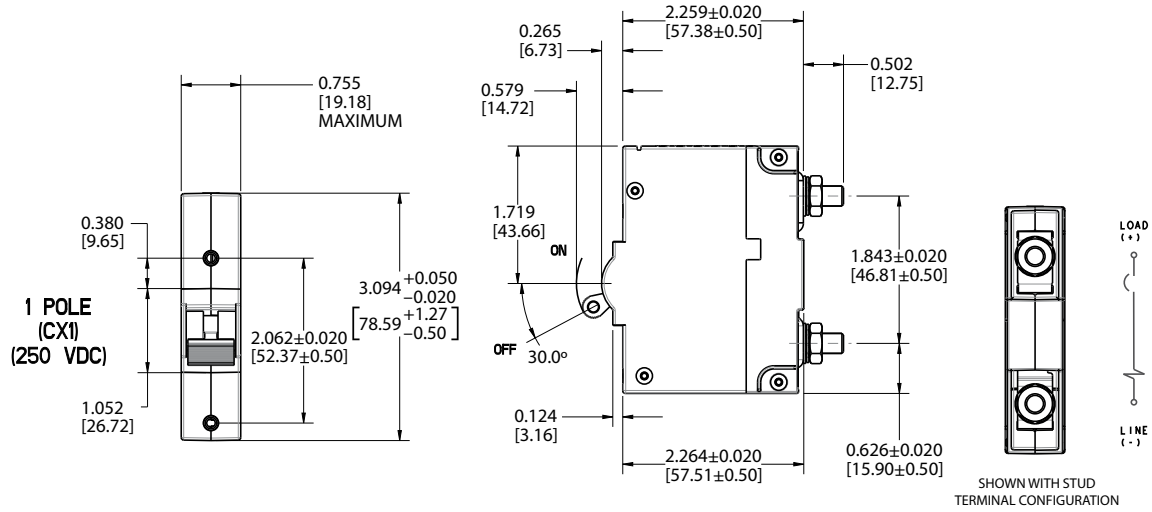

Notes:

- 1 All dimensions are in inches [millimeters].
- 2 Tolerance  $\pm 0.020 [5.1]$  unless otherwise specified.

## Dimensional Specifications: in. [mm]

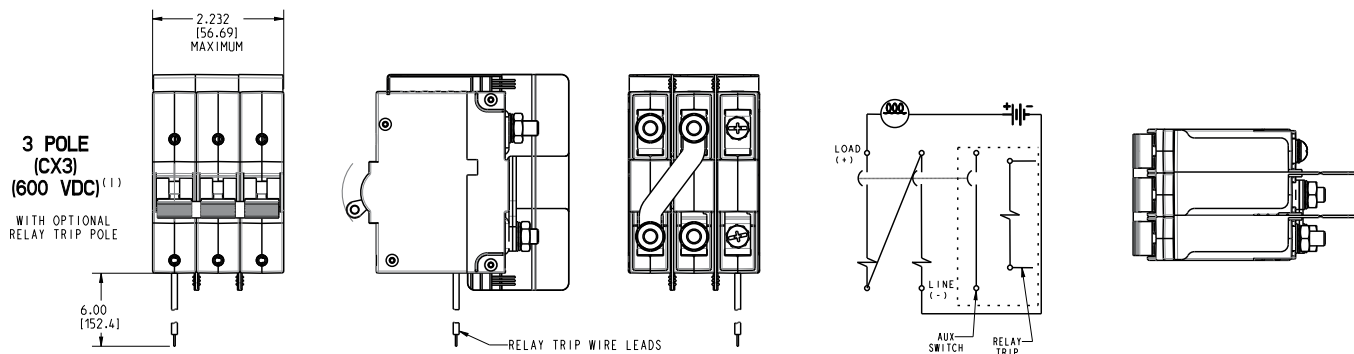
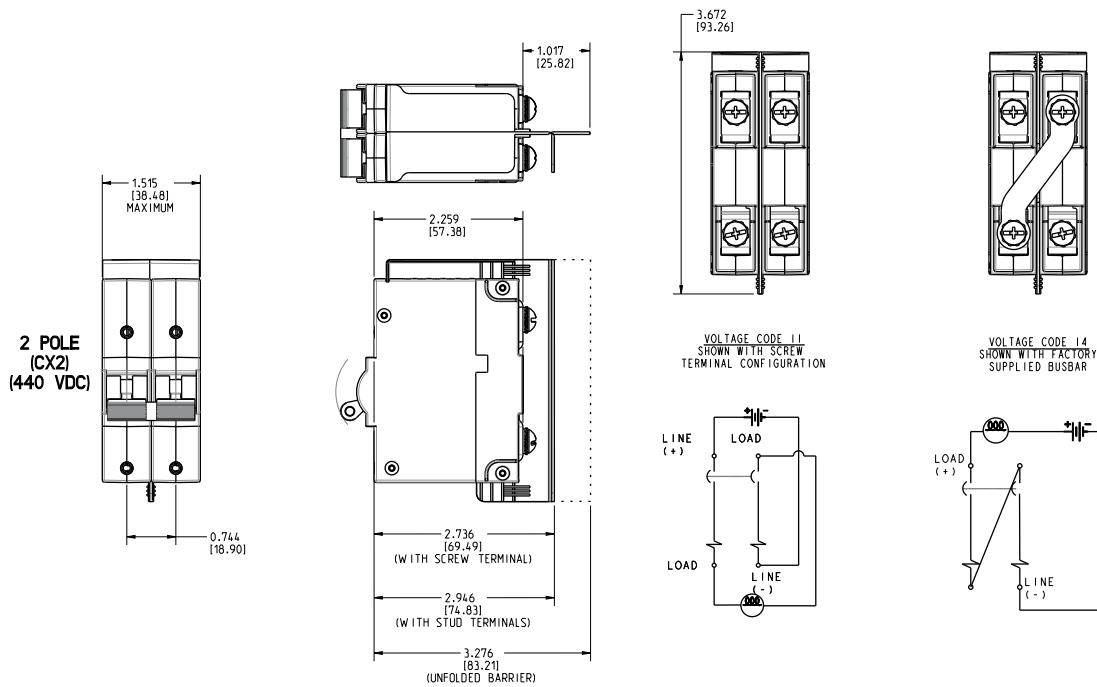
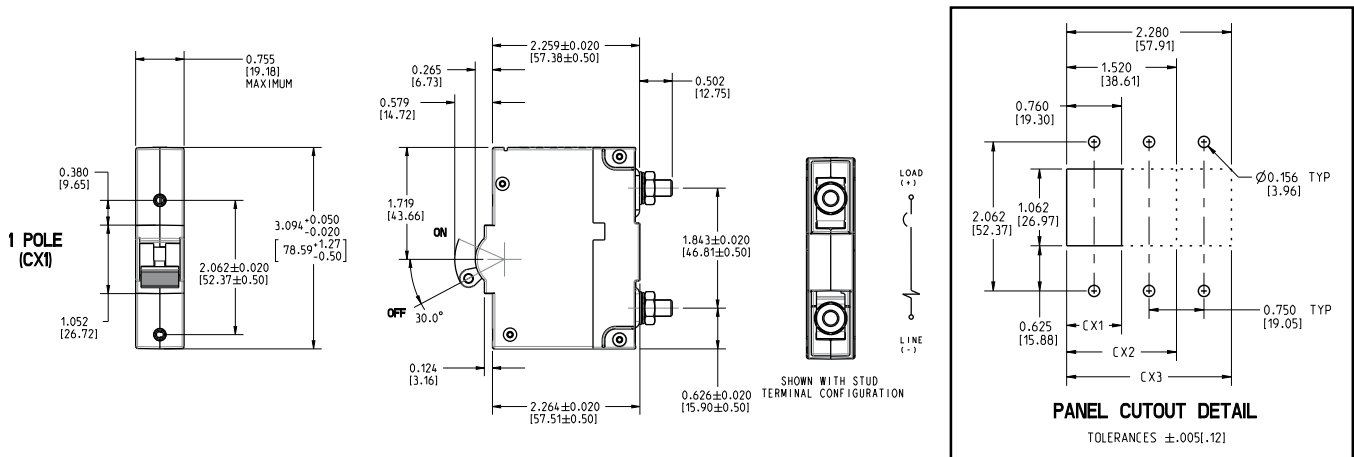

- Notes:
- 1 All dimensions are in inches [millimeters].
  - 2 600V Rating requires minimum of 2 protected poles

# M-Series

## CIRCUIT BREAKER

The M-Series is a low cost, miniature, hydraulic-magnetic circuit breaker which features a compact, space saving design, front panel snap-in mounting and a vertically mounted parallel pole configuration. It features various styling options to maximize your design flexibility. Choices include rocker, illuminated rocker, paddle and baton style handle actuators, push-to-reset and push-pull pushbutton actuators, as well as Visi-Rocker two color actuators. Our exclusive Rockerguard bezel helps prevent inadvertent actuation and a wiping contact mechanism assures long-term reliability.

The M-Series circuit breakers are available with 1, 2 or parallel poles, 0.02 to 50 amp ratings, and 125 and 250VAC or 80VDC versions. With over 16 different time delays, 5 terminal styles, a variety of panel hardware, various colors, and legend imprinting, it assures suitability for most any application design.



### Resources:

[Download 3D CAD Files](#)

[IGS >](#)

[STP >](#)

### Product Highlights:

- Parallel pole configuration fits in one rack unit
- MIL-PRF-55629
- MIL STD 202 compliant
- MIL-PRF-39019F ingress protection
- Sealed toggle actuator
- Compact design

Only Telecom-Datcom applicable ordering schemes and drawings are shown in this catalog. For complete product details, please visit [www.carlingtech.com](http://www.carlingtech.com)

**Electrical**

Maximum Voltage 125/250 VAC 50/60 Hz, 80 VDC (See Rating Tables.)

Current Ratings Standard current coils: 0.100, 0.250, 0.500, 0.750, 1.00 thru 15.0 in 1 amp increments, 18.0, 20.0, 25.0, 30.0. Other ratings available - see Ordering Scheme.

Auxiliary Switch Rating SPDT; 7A 250VAC, 7A (Res) 28VDC, 4A (Ind.) 28VDC, 0.25A 80VDC (Res) (silver contacts), 0.1A 125VAC (gold contacts).

Insulation Resistance Minimum of 100 Megohms at 500 VDC.

Dielectric Strength UL, CSA 1500V, 50/60 Hz for one minute between all electrically isolated terminals. M-Series Circuit Breakers comply with the 8mm spacing and 3750 V 50/60Hz dielectric requirements from hazardous voltage to operator accessible surfaces, per Publications IEC 380, 435, 950, EN 60950 and VDE 0805.

Resistance, Impedance Values from Line to Load Terminal - based on Series Trip Circuit Breaker.

**Mechanical**

Endurance 10,000 ON-OFF operations @ 6 per minute with rated Current and Voltage.

Trip Free All M-Series Circuit Breakers will trip on overload, even when actuator is forcibly held in the ON position.

Trip Indication The actuator moves positively to the OFF position when an overload causes the circuit breaker to trip.

**Physical**

Number of Poles 1 or 2

Internal Circuit Configs. Series with or without Auxiliary Switch. Switch Only with or without Auxiliary Switch.

Weight Approximately 30 grams/pole (Approximately 1.07 ounces/pole)

Standard Colors See Ordering Scheme

**Environmental**

Designed in accordance with requirements of specification MIL PRF-55629 & MIL-STD-202G as follows:

Shock Withstands 100 Gs, 6ms, sawtooth while carrying rated current per Method 213, Cond. I. Instantaneous curves tested at 80% of rated current.

Vibration Withstands 0.060" excursion from 10-55 Hz, and 10 Gs 55-500 Hz, at rated current per Method 204C, Test Condition A. Instantaneous curves tested at 80% of rated current.

Moisture Resistance Method 106D, i.e., ten 24-hour cycles @ + 25°C to +65°C, 80-98% RH.

Salt Spray Method 101, Condition A (90-95% RH @ 5% NaCl Solution, 96 hrs).

Thermal Shock Method 107D, Condition A (Five cycles @ -55°C to +25°C to +85°C to +25°C).

Operating Temperature -40° C to +85° C

Chemical Resistance Only the outside surfaces of the case and the handles may be cleaned with detergents or alcohol. Organic (hydrocarbon based) solvents are not recommended because they attack plastics. Caution should be taken when solvents are used to clean and remove flux from terminals. Lubricants should not be introduced into the handle/ bushing openings

RESISTANCE PER POLE VALUES from Line to Load Terminals (Values Based on Series Trip Circuit Breaker)

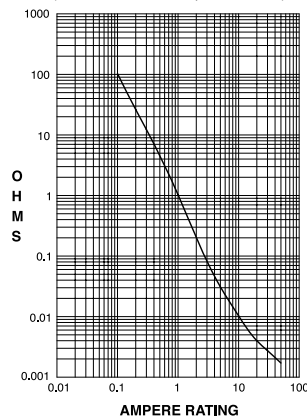

CURRENT (AMPS)	TOLERANCE (%)
0.10 - 20.0	± 25
20.1 - 50.0	± 35

**Pulse Tolerance Curves**

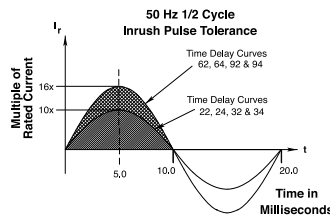
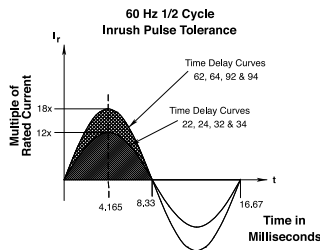

\*Manufacturer reserves the right to change product specification without prior notice.

Electrical Tables

**Table A:** Lists UL Recognized and CSA Accepted configurations & performance capabilities as a Component Supplementary Protector.

M-SERIES TABLE A: COMPONENT SUPPLEMENTARY PROTECTORS										
Circuit Configuration	Voltage			Current Rating		Poles Breaking	Short Circuit Capacity (Amps)		Application Codes	
	Max Rating	Frequency	Phase	Full Load Amps	General Purpose Amps		UL / CSA		UL	CSA
							With Backup Fuse	Without Backup Fuse		
Series	32	DC	---	0.02 - 15	---	1	---	1000	TC1, 2, OL1, U1	TC1, 2, OL1, U1
				---	15.1 - 25	1	---	1000	TC1, 2, OL0, U1	TC1, 2, OL0, U1
	50 <sup>2</sup>	DC	---	0.02 - 7.5	---	1	---	1000	TC1, 2, OL0, U1	TC1, 2, OL0, U1
				0.02 - 15	---	2	---	1000	TC1, 2, OL1, U1	TC1, 2, OL1, U1
	65	DC	---	---	15.1 - 25	2	---	1000	TC1, 2, OL0, U1	TC1, 2, OL0, U1
				0.02 - 15	---	1	---	1000	TC1, 2, OL1, U1	TC1, 2, OL1, U1
	65 <sup>1,2</sup>	DC	---	---	15.1 - 30	1	---	1000	TC1, 2, OL0, U1	TC1, 2, OL0, U1
				0.02 - 15	---	2	5000 <sup>3</sup>	---	TC1, 2, OL1, C1	TC1, 2, OL1, C1
	65	DC	---	---	15.1 - 25	2	5000 <sup>3</sup>	---	TC1, 2, OL0, C1	TC1, 2, OL0, C1
				0.02 - 15	---	1	---	600	TC1, 2, OL1, U1	TC1, 2, OL1, U1
	80 <sup>1</sup>	DC	---	---	15.1 - 30	1	---	600	TC1, 2, OL0, U1	TC1, 2, OL0, U1
				0.02 - 15	---	1	---	1000	TC1, 2, OL1, U1	TC1, 2, OL1, U1
	125	50 / 60	1	0.02 - 15	---	1	---	1000	TC1, 2, OL1, U1	TC1, 2, OL1, U1
				---	15.1 - 30	1	---	1000	TC1, 2, OL0, U1	TC1, 2, OL0, U1
1 - 30				---	1	---	360	TC1, OL1, U2	TC3, OL1, U3	
250 <sup>2</sup>	50 / 60	1	0.02 - 12	---	1	---	1000	TC1, 2, OL1, U1	TC1, 2, OL1, U1	
250	50 / 60	1	---	12.1 - 18	1	1000 <sup>4</sup>	---	TC1, 2, OL0, C1	TC1, 2, OL0, C1	
250	50 / 60	1	0.02 - 15	---	2	---	1000	TC1, 2, OL1, U1	TC1, 2, OL1, U1	
			---	15.1 - 30	2	---	1000	TC1, 2, OL0, U1	TC1, 2, OL0, U1	
			1 - 30	---	2	---	360	TC1, OL1, U2	TC3, OL1, U3	

- Notes:  
 1 Polarity Sensitive  
 2 Available only with Special Catalog Number. Consult Factory.  
 3 Requires Branch Circuit Backup with a UL Listed type K-5 or RK-5 fuse rated 30 Amps maximum  
 4 Requires Branch Circuit Backup with a UL Listed type K-5 or RK-5 fuse rated 60 Amps maximum

**Table B:** Lists UL Recognized, CSA Accepted and TUV and VDE Certified configurations and performance capabilities as a Component Supplementary Protector.

M-SERIES TABLE B: COMPONENT SUPPLEMENTARY PROTECTORS												
Circuit Configuration	Voltage			Current Rating		Poles Breaking	Short Circuit Capacity (Amps)				Application Codes	
	Max Rating	Frequency	Phase	Full Load Amps	General Purpose Amps		UL / CSA		VDE / TUV		UL	CSA
							With Backup Fuse	Without Backup Fuse	With Backup Fuse	Without Backup Fuse		
Series	32	DC	---	0.02 - 15	---	1	---	1000	3000	500	TC1, 2, OL1, U1	TC1, 2, OL1, U1
				---	15.1 - 25	1	---	1000	3000	500	TC1, 2, OL0, U1	TC1, 2, OL0, U1
	50 <sup>2</sup>	DC	---	0.02 - 7.5	---	1	---	1000	3000	500	TC1, 2, OL0, U1	TC1, 2, OL0, U1
				0.02 - 15	---	2	---	1000	3000	500	TC1, 2, OL1, U1	TC1, 2, OL1, U1
	65	DC	---	---	15.1 - 25	2	---	1000	3000	500	TC1, 2, OL0, U1	TC1, 2, OL0, U1
				0.02 - 15	---	2	5000	---	3000	500	TC1, 2, OL1, C1	TC1, 2, OL1, C1
	65 <sup>3</sup>	DC	---	---	15.1 - 30	2	5000	---	3000	500	TC1, 2, OL0, C1	TC1, 2, OL0, C1
				0.02 - 15	---	1	---	600 <sup>4</sup>	---	500	TC1, 2, OL1, U1	TC1, 2, OL1, U1
	80 <sup>1</sup>	DC	---	---	15.1 - 30	1	---	600 <sup>4</sup>	---	500	TC1, 2, OL0, U1	TC1, 2, OL0, U1
				0.02 - 15	---	1	---	1000	3000	500	TC1, 2, OL1, U1	TC1, 2, OL1, U1
	125	50 / 60	1	0.02 - 15	---	1	---	360	3000	500	TC1, OL1, U2	TC3, OL1, U3
				1 - 15	---	1	---	1000	3000	500	TC1, 2, OL1, U1	TC1, 2, OL1, U1
	250	50 / 60	1	0.02 - 12	---	1	---	1000	3000	500	TC1, 2, OL1, U1	TC1, 2, OL1, U1
				0.02 - 20	---	2	---	1000	3000	500	TC1, 2, OL0, U1	TC1, 2, OL0, U1
1 - 12				---	1	---	360	3000	500	TC1, OL1, U2	TC3, OL1, U3	

- Notes:  
 1 Polarity Sensitive  
 2 Available only with Special Catalog Number. Consult Factory.  
 3 Requires Branch Circuit Backup with a UL Listed type K-5 or RK-5 fuse rated 30 Amps maximum  
 4 TUV only, not VDE  
 5 Requires backup protection with a thermal magnetic circuit breaker rated 32 amps and having a Type C trip characteristic per EN60898/DIN VDE 0641 (C32A) for ratings greater than 15amps, and a thermal magnetic circuit breaker rated 16 amps and having a Type C trip characteristic per EN60898/DIN VDE 0641 (C16A) for ratings 15 amps and less

## Electrical Tables

**Table C:** Lists UL489A Listed and TUV Certified configurations and performance capabilities for use in Communications Equipment.

M-SERIES TABLE C: UL489A Listed (Communications Equipment - Polarity Sensitive)						
Circuit Configuration	Voltage		Current Rating General Purpose Amps	Poles Breaking	Interrupting Capacity (Amps)	
	Max Rating	Frequency			Without Backup Fuse	
					UL489A	TUV
Series	80	DC	0.02 - 30	1	600	---
	65 <sup>1</sup>	DC	0.02 - 30	1	1000	---
	80	DC	0.10 - 30	1	600	600

Notes:  
1. Available only with Special Catalog Number

**Table D:** Lists UL489A Listed configurations and performance capabilities for use in Communications Equipment.

M-SERIES TABLE D: Parallel Pole Construction UL489A Listed (Communications Equipment - Polarity Sensitive)						
Circuit Configuration	Voltage		Current Rating General Purpose Amps	Poles Breaking	Interrupting Capacity (Amps)	
	Max Rating	Frequency			Without Backup Fuse	
					UL489A	
Series	80	DC	31 - 50	2	600	
	65 <sup>1</sup>	DC	31 - 50	2	1000	

Notes:  
1. Available only with Special Catalog Number

## Agency Certifications

**UL Recognized**  
UL Standard 1077  

Component Recognition Program as Protectors, Supplementary (Guide CCN/QVNU2, File E75596)

**CSA Accepted**  

Component Supplementary Protector (Class 3215 30, File 047848 0 000)  
CSA Standard C22.2 No. 235

**UL Listed**  
UL Standard 489A  

Communications Equipment (Guide CCN/DITT, File E189195)

**VDE Certified**  

EN60934, VDE 0642 under File 10537

**TUV Certified**  

EN60934, under License No. R9671109



**1 SERIES**  
M

**2 ACTUATOR**

**Single Color**  
A Angled  
B Flat

**Two Color Visi**  
D Indicate ON  
E Indicate OFF

**Single Color Translucent**  
F Angled  
G Flat

STYLE	INDICATE - "ON" (CODE-D)	INDICATE - "OFF" (CODE-E)	FLAT (CODES-B & G)	ANGLED (CODES-A & F)
VERTICAL				
HORIZONTAL				

**3 POLES**  
2 Two

**4 CIRCUIT/AUXILIARY SWITCH 2**  
P Series Trip Current (Parallel Pole)  
**with Auxiliary Switch, Silver Contacts**  
Q Series Trip Current (Parallel Pole) .110 x 0.20 Q.C  
**with Auxiliary Switch, Gold Contacts**  
R Series Trip Current (Parallel Pole) .110 x 0.20 Q.C

**5 FREQUENCY & TIME DELAY**  
D2 DC Short  
D4 DC Medium

**6 CURRENT RATING (AMPERES)**

CODE	AMPERES
631	31.000
635	35.000
640	40.000
645	45.000
650	50.000

**7 TERMINAL**  
A Push in Stud  
5 10-32 Screw (Bus Type)

**8 ILLUMINATION**  
**Non-Illuminated**  
A Non-Illuminated

**9 ACTUATOR COLOR & LEGEND**

	Actuator Visi 1	Legend
1	White	Black
2	Black	White
3	Red	White
4	Green	White
5	Blue	White
6	Yellow	Black
7	Gray	Black
8	Orange	Black

**10 LEGEND**  
2 ON - OFF Vertical  
3 ON - OFF Horizontal  
6 Dual Vertical  
7 Dual Horizontal

**11 BEZEL COLOR**  
A White without Rockerguard  
B Black without Rockerguard  
G Gray without Rockerguard  
1 White with Rockerguard  
2 Black with Rockerguard  
7 Gray with Rockerguard

**12 AGENCY APPROVAL**  
T UL 489A Listed

Notes:  
1 Reminder of Rocker same color as Visi  
2 Aux Switch only available with screw terminals



**1 SERIES**  
M

**2 ACTUATOR**  
M Paddle  
T Push-Pull

**3 POLES**  
2 Two

**4 CIRCUIT/AUXILIARY SWITCH 1**  
P Series Trip Current (Parallel Pole)  
**with Auxiliary Switch, Silver Contacts**  
Q Series Trip Current (Parallel Pole) .110 x 0.20 Q.C  
**with Auxiliary Switch, Gold Contacts**  
R Series Trip Current (Parallel Pole) .110 x 0.20 Q.C

**5 FREQUENCY & TIME DELAY**  
D2 DC Short  
D4 DC Medium

**6 CURRENT RATING (AMPERES)**

CODE	AMPERES
631	31.000
635	35.000
640	40.000
645	45.000
650	50.000

**7 TERMINAL**  
A Push in Stud  
5 10-32 Screw (Bus Type)

**8 ACTUATOR COLOR & LEGEND**

Handle		Push Button	
1	White	A	White
2	Black	B	Black
3	Red	C	Red
4	Green	D	Green
5	Blue	E	Blue
6	Yellow	F	Yellow
7	Gray	G	Gray
8	Orange	H	Orange

**9 FRONT PANEL HARDWARE**

**Handle**

- A No outer Panel Hardware
- B Knurled Nut, Bright Nickel
- C Knurled Nut, Bright Nickel with Locking Ring
- D Knurled Nut, Black
- E Knurled Nut, Black with Locking Ring
- F Panel Dress, Bright Nickel
- G Panel Dress, Bright Nickel with Locking Ring
- H Panel Dress, Black
- J Panel Dress, Black with Locking Ring

**Push Button**

- 1 No outer Panel Hardware
- 2 Knurled Nut, Bright Nickel

**10 LEGEND PLATE / BUTTON MARKING**

**Handle Actuator Legend Plate**

- B ON - OFF Vertical
- C ON - OFF Horizontal

**Push-Pull Actuator Legend Plate**

- 2 Rated Amps Horizontal
- 3 Rated Amps Line Side Down
- 4 Rated Amps Line Side Up

**11 BRUSHING COLOR**  
B Black

**12 AGENCY APPROVAL**  
T UL 489A Listed

Notes:  
1 Aux Switch only available with screw terminals



## Dimensional Specifications: in. [mm]

### PARALLEL POLE TERMINAL OPTIONS

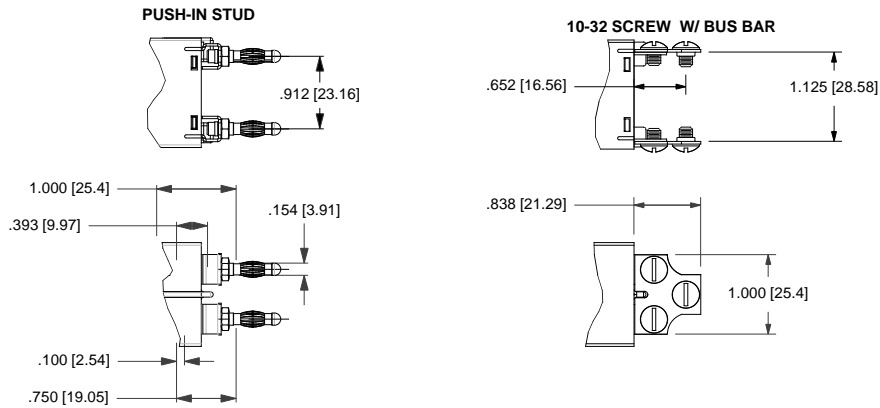

### ROCKER ACTUATOR DETAIL

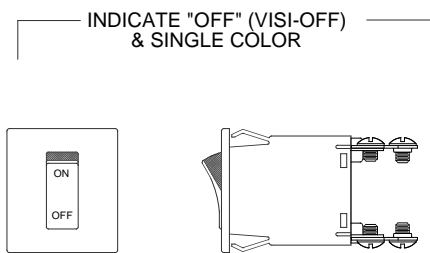
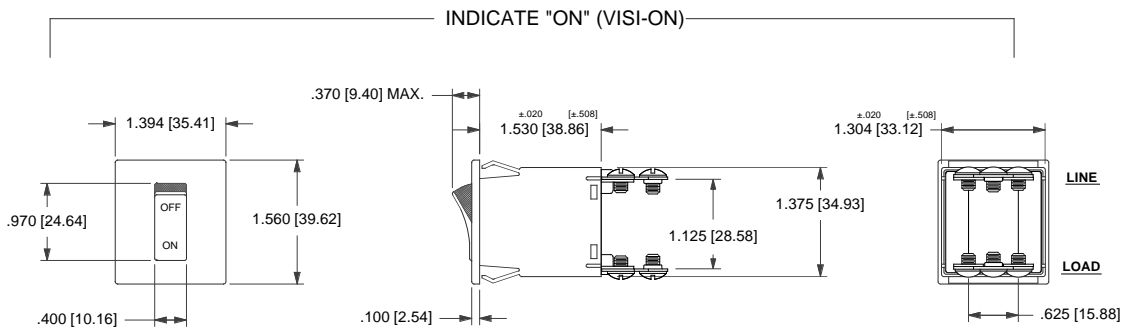

### ROCKERGUARD CONFIGURATION

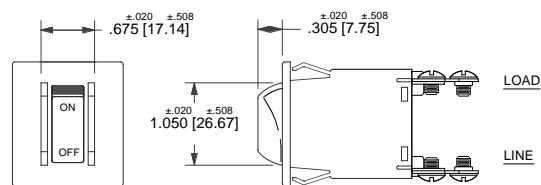

### PANEL CUT - OUT DETAIL (ROCKER)

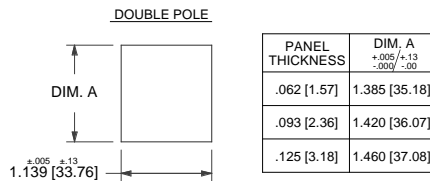

Notes:

- 1 All dimensions are in inches [millimeters].
- 2 Tolerance  $\pm 0.10$  [2.5] unless otherwise specified.
- 3 Dimensions apply to both rocker styles.
- 4 I-o, on-off or dual legends available for vertical or horizontal mounting.
- 5 Notice that circuit breaker line and load terminal orientation on indicate "off" is opposite that of indicate "on".

## Dimensional Specifications: in. [mm]

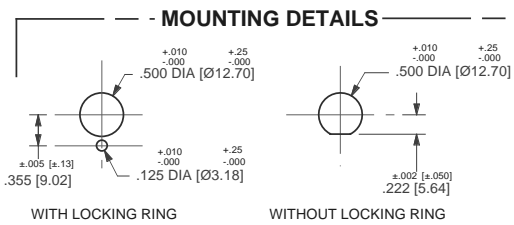
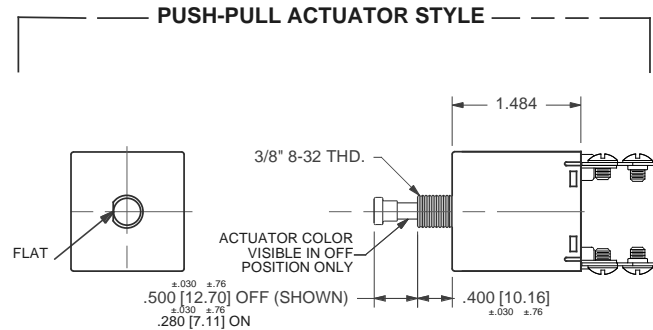
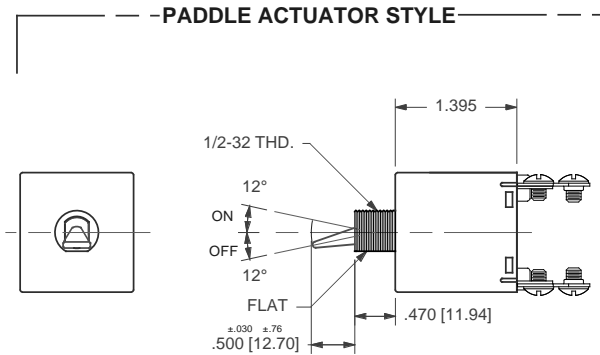

**MOUNTING DETAILS**

**PANEL HARDWARE**

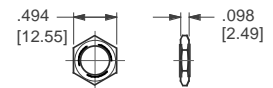
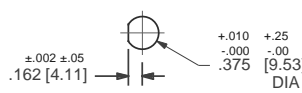

**PUSH-PULL, PUSH TO RESET**

**HEX NUT**

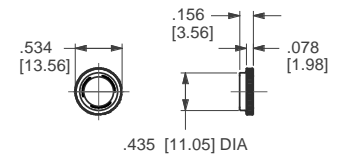

**SNAP-IN BUSHING**

**PANEL DRESS NUT**

**LEGEND PLATES**

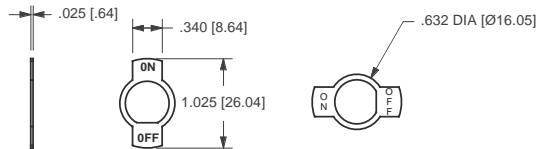

LEGEND CODE:

B

C

**BUTTON MARKING ORIENTATION**

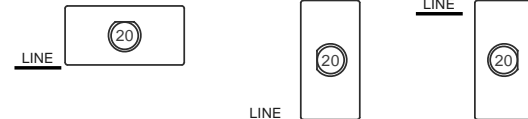

MARKING CODE:

2

3

4

**PANEL HARDWARE**

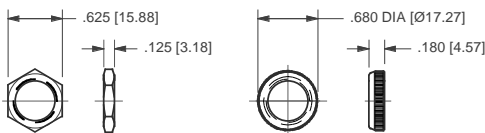

**HEX NUT**

**PANEL DRESS NUT**

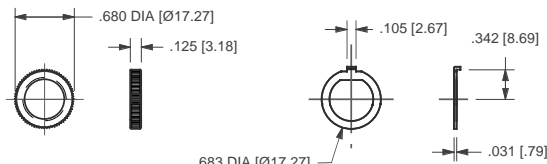

**KNURLED NUT**

**LOCKING RING**

**.110QC AUXILIARY SWITCH TERMINALS**

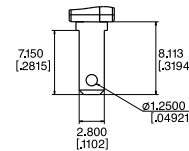

Notes:

- All dimensions are in inches [millimeters].
- Tolerance ±.010 [.25] unless otherwise specified.
- Dimensions apply to both rocker styles.
- I-o, on-off or dual legends available for vertical or horizontal mounting.
- Notice that circuit breaker line and load terminal orientation on indicate "off" is opposite that of indicate "on".

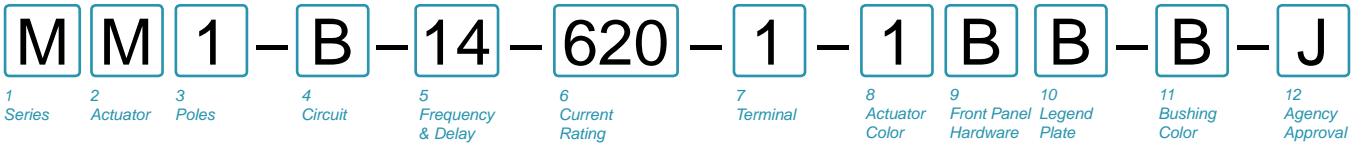

**1 SERIES**  
M

**2 ACTUATOR 1**

**Handle**  
M Paddle N Baton

**Push Button**  
T Push-Pull

**Push Button with Snap-In Mounting**  
V Push-Pull

U 8 Push To Reset

W 8 Push To Reset

**3 POLES**  
1 One

**4 CIRCUIT**

**without Auxiliary Switch**  
B Series Trip (Current)

**with Auxiliary Switch, Silver Contacts**  
M Series Trip (Current) Aux Switch  
S 3 Series Trip (Current)  
T 3,4 Series Trip (Current)  
U 3,13 Series Trip, Maintained Contacts

**Terminal Type:**  
.110 QC x .020 QC  
.060 Dia, Round Solder Turret  
.058 Dia, Round Q.C.  
.080 Dia x .020 Flat Q.C.

**with Auxiliary Switch, Gold Contacts**  
4 2,3 Series Trip (Current) .058 Dia, Round Q.C.  
5 3,12 Series Trip, Maintained Contacts .080 Dia x .020 Flat Q.C.  
9 Series Trip (Current) Aux Switch .110 QC x .020 QC

**5 FREQUENCY & DELAY**

10 DC Instantaneous	72 DC, Short, Hi-Inrush
12 DC Short	74 DC, Medium, Hi-Inrush
14 DC Medium	

**6 CURRENT RATING (AMPERES)**

CODE	AMPERES				
020	0.020	225	0.250	420	2.000
025	0.025	230	0.300	522	2.250
030	0.030	235	0.350	425	2.500
035	0.035	240	0.400	527	2.750
040	0.040	245	0.450	430	3.000
045	0.045	250	0.500	435	3.500
050	0.050	255	0.550	440	4.000
055	0.055	260	0.600	445	4.500
060	0.060	265	0.650	450	5.000
065	0.065	270	0.700	455	5.500
070	0.070	275	0.750	460	6.000
075	0.075	280	0.800	465	6.500
080	0.080	285	0.850	470	7.000
085	0.085	290	0.900	475	7.500
090	0.090	295	0.950	480	8.000
090	0.095	410	1.000	485	8.500
210	0.100	512	1.250	490	9.000
215	0.150	415	1.500	495	9.500
220	0.200	517	1.750	610	10.000

**7 TERMINAL 4**

1 Push-On 0.250 Tab (Q.C.)	A 10 Push-In Stud
2 Screw 8-32 with Upturned Lugs	P 11 Printed Circuit Board
3 Screw 8-32 (Bus Type)	

**8 ACTUATOR COLOR & LEGEND 5**

Gloss Handle	Push-Button	Actuator Color
1	A	White
2	B	Black
3	C	Red
4	D	Green
5	E	Blue
6	F	Yellow
8	H	Orange

**9 FRONT PANEL HARDWARE 6**

No outer Panel Hardware	Handle	Push-Button
<b>Knurled Nut</b>	A	1
Bright nickel	B	2
Bright nickel with locking ring	C	
Black	D	
Black with locking ring	E	
<b>Panel Dress Nut</b>	F	
Bright nickel	G	
Bright nickel with locking ring	H	
Black	J	
Black with locking ring		

**10 LEGEND PLATE / BUTTON MARKING**

**Handle Actuator Legend Plate (Actuator Styles M & N)**

- A No Legend Plate
- B ON - OFF Vertical
- C ON - OFF Horizontal
- D I - O Vertical
- E I - O Horizontal

**Push-Pull Actuator Button Cap (Actuator Styles T & V)**

- 1 8 No Marking
- 2 Rated Amps Horizontal
- 3 Rated Amps Line Side Down
- 4 Rated Amps Line Side Up

**Push-to-Reset Actuator Button (Actuator Styles U & W)**

- 1 8 No Marking

**11 BUSHING COLOR 7**

B Black

**12 AGENCY APPROVAL 9**

- J UL489A Listed, TUV Certified
- M UL Recognized, CSA Accepted
- N UL Recognized, TUV Certified
- T UL489A Listed

1 One actuator is located in the center of each multi-pole breaker. Actuator codes V & W limited to single pole breakers only.  
 2 One Auxiliary Switch is supplied per breaker. On two-pole breakers, standard Auxiliary Switch mounting is in pole one. Auxiliary Switch option limited to Series Trip and Switch Only circuits. Not available with Back Connected Screw or Push-in Stud terminals.  
 3 Mates with AMP .058" diameter pin receptacles including 60983-1 (gold plated) and 60983-3 (tin plated).  
 4 Screw terminals or Push-in Stud recommended above 20 amps.  
 5 Actuator color is only visible in the OFF position on Push-Pull actuators.  
 6 All units have one hex nut installed on bushing for use behind the panel.  
 7 Other colors available. Consult factory.  
 8 Not available with UL489A Listed breakers.  
 9 TUV certified to 25 amps. UL Recognized, CSA Accepted and UL Listed to 30 amps.  
 10 Terminal code A available with circuit codes A & B only.  
 11 Printed circuit board available with UL recognized approval only.  
 12 Auxiliary switch (flat Q.C.) available with UL recognized approvals only.

# Circuit & Terminal Diagrams: in. [mm]

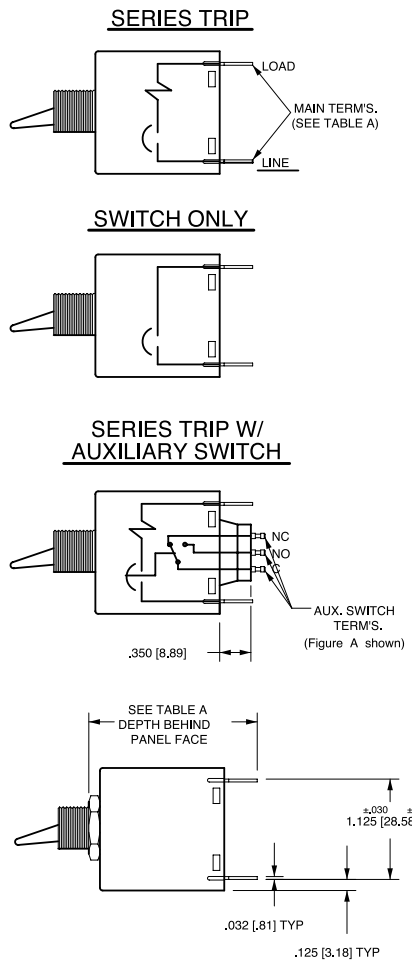

TERMINAL DESCRIPTION		DEPTH BEHIND PANEL FACE *
MAIN	TAB (Q.C)	1.890 [48.00]
	SCREW (#8-32)	1.930 [49.03]
	PUSH-IN STUD	2.520 [64.00]
AUX. ** SWITCH	DOUBLE SOLDER TURRET TYPE	2.035 [51.68]
	ROUND Q.C TYPE	2.025 [51.44]
	FLAT QUICK-CONNECT FLAT SOLDER LUG	2.129 [54.08] 2.012 [51.10]

\*DEPTH INCLUDES BEHIND PANEL HEX NUT AS SUPPLIED ON ALL UNITS.

\*\* WHEN CALLED FOR ON MULTI-POLE UNITS, ONLY ONE AUX. SWITCH IS NORMALLY SUPPLIED, MOUNTED AS SHOWN IN FIG. A

## MULTI-POLE IDENTIFICATION SCHEME

SOLDER TURRET AND ROUND QC AUX SWITCH TERMINALS

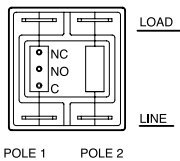

FIG. A

FLAT QC AND SOLDER LUG AUX SWITCH TERMINALS

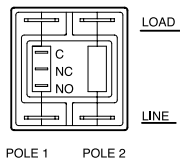
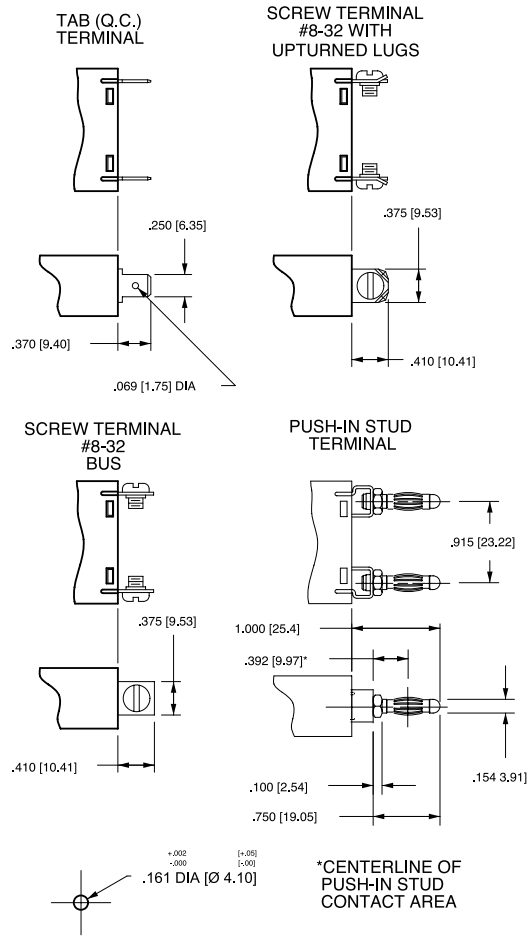
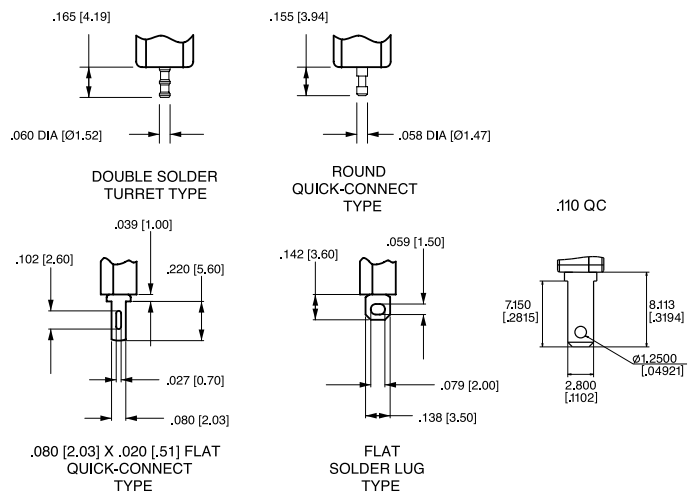

FIG. B

## TERMINAL DIMENSIONAL DETAIL



## AUXILIARY SWITCH TERMINALS



\*AVAILABLE THROUGH SPECIAL CATALOG PART NUMBER

Notes:

- All dimensions are in inches [millimeters].
- Tolerance ±.020 [.51] unless otherwise specified.

# PC Terminal Diagrams: in. [mm]

## HANDLE TYPE SHOWN WITHOUT AUX. SWITCH

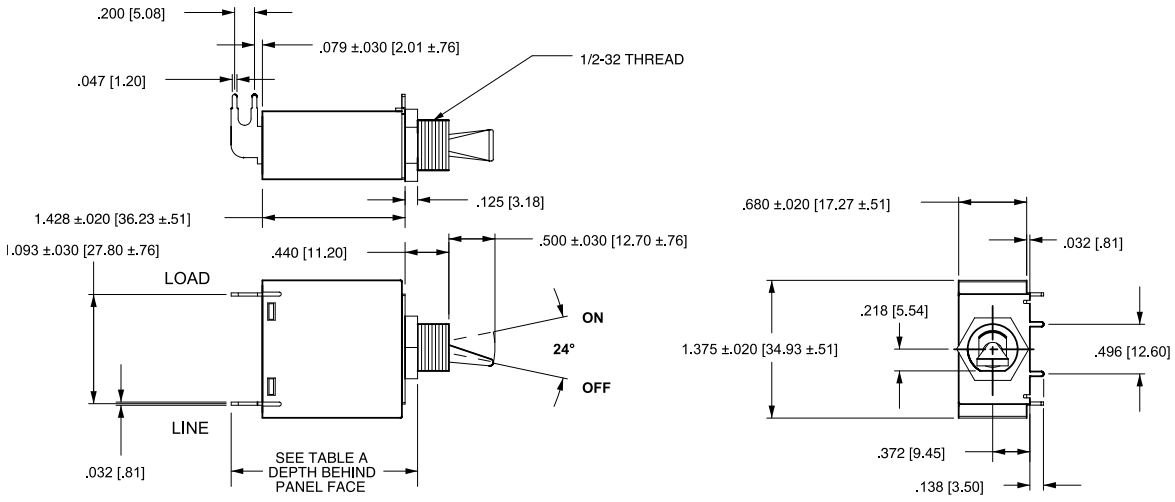

### P.C. FOOTPRINT

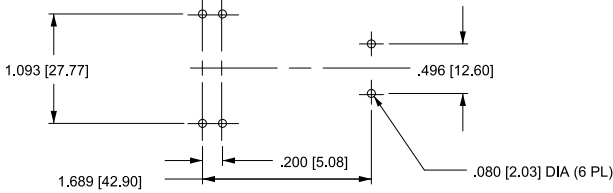

### P.C. TERMINAL

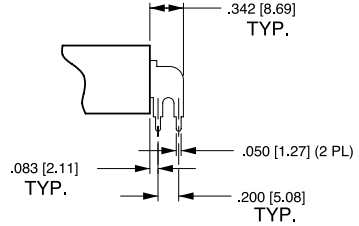

## HANDLE TYPE SHOWN WITH AUX. SWITCH

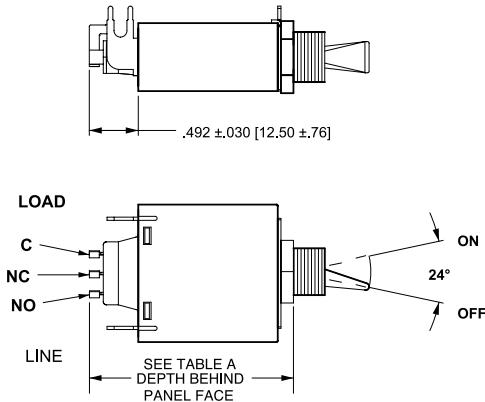

### P.C. FOOTPRINT

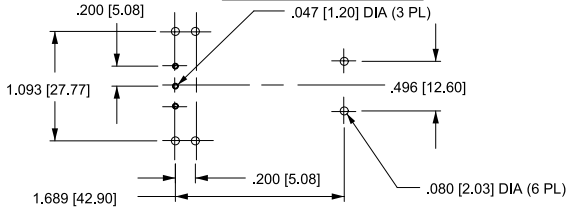

### PANEL HARDWARE

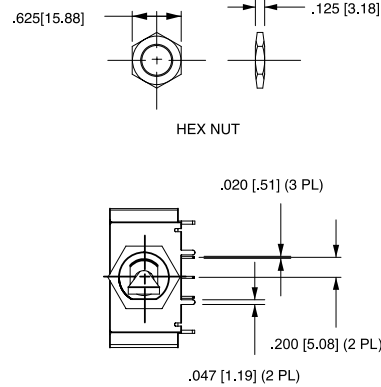
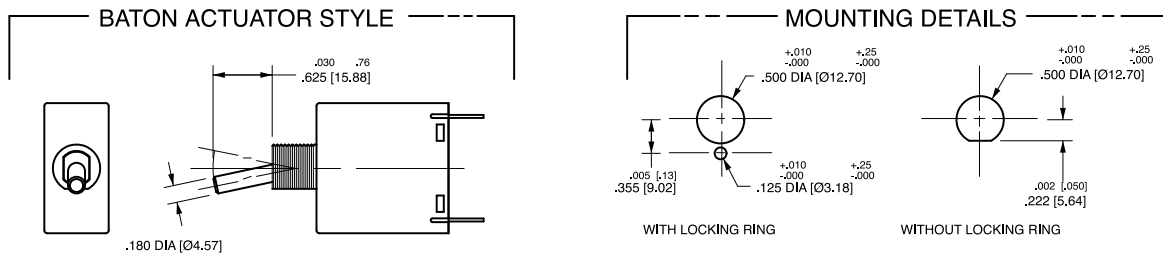
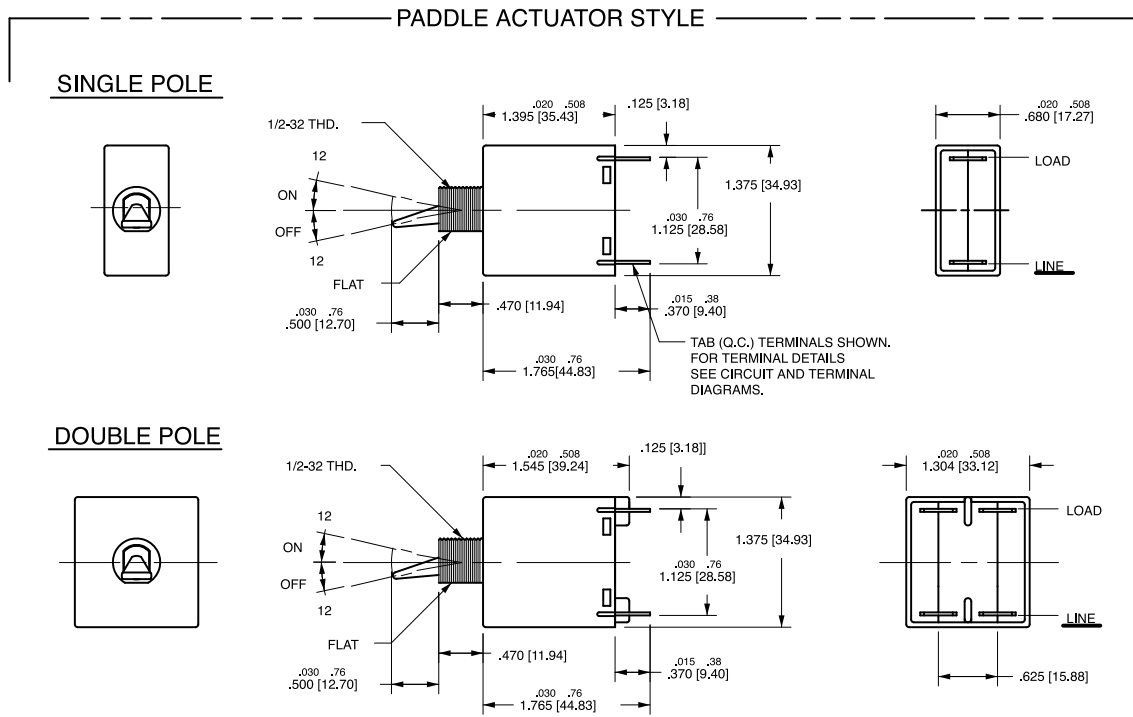

TABLE A		
	TERMINAL DESCRIPTION	DEPTH BEHIND PANEL FACE *
MAIN	PRINTED CIRCUIT BOARD	1.957 [49.71]
AUX. SWITCH	PRINTED CIRCUIT BOARD	2.449 [62.20]

\*DEPTH INCLUDES BEHIND PANEL HEX NUT AS SUPPLIED ON ALL UNITS

- Notes:  
 1 All dimensions are in inches [millimeters].  
 2 Tolerance  $\pm 0.020$  [51] unless otherwise specified.

## Dimensional Specifications: in. [mm]



### LEGEND PLATES

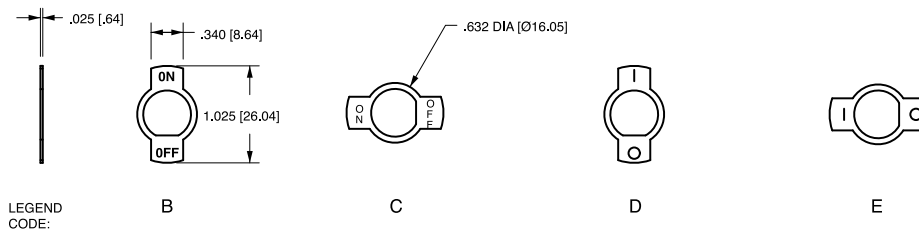

### PANEL HARDWARE

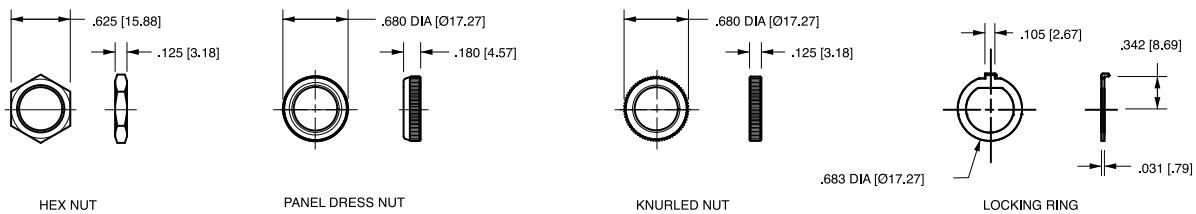

Notes:  
 1 All dimensions are in inches [millimeters].  
 2 Tolerance  $\pm 0.020$  [.51] unless otherwise specified.

# Circuit & Terminal Diagrams: in. [mm]

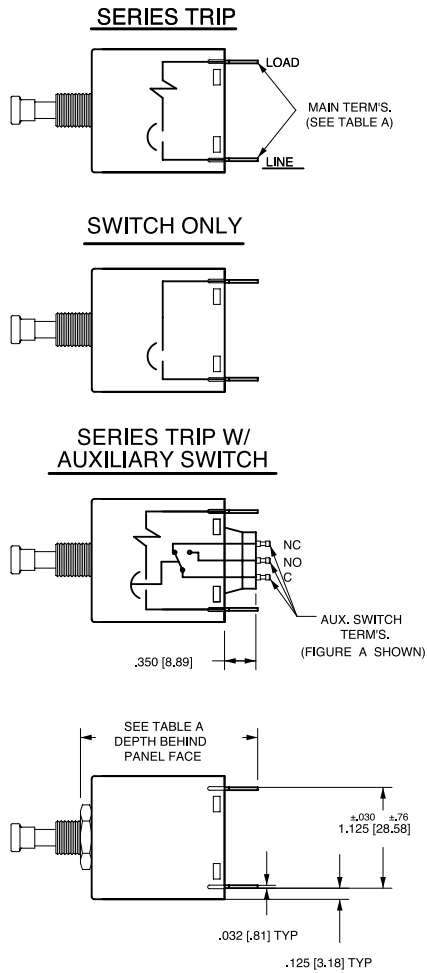

TABLE A		
TERMINAL DESCRIPTION		DEPTH BEHIND PANEL FACE *
MAIN	TAB (Q.C.)	1.952 [49.57]
	SCREW (#8-32)	1.992 [50.60]
	PUSH-IN STUD	2.582 [65.58]
AUX. ** SWITCH	DOUBLE SOLDER TURRET TYPE	2.097 [53.26]
	ROUND Q.C. TYPE	2.087 [53.01]
	FLAT QUICK-CONNECT	2.191 [55.65]
	FLAT SOLDER LUG	2.074 [52.68]

\*DEPTH INCLUDES BEHIND PANEL HEX NUT AS SUPPLIED ON ALL UNITS.

\*\*WHEN CALLED FOR ON MULTI-POLE UNITS, ONLY ONE AUX. SWITCH IS NORMALLY SUPPLIED, MOUNTED AS SHOWN IN FIG. A

## MULTI-POLE IDENTIFICATION SCHEME

SOLDER TURRET AND ROUND QC AUX SWITCH TERMINALS

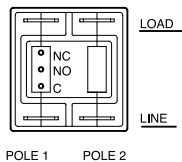

FIG. A

FLAT QC AND SOLDER LUG AUX SWITCH TERMINALS

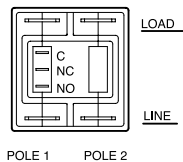
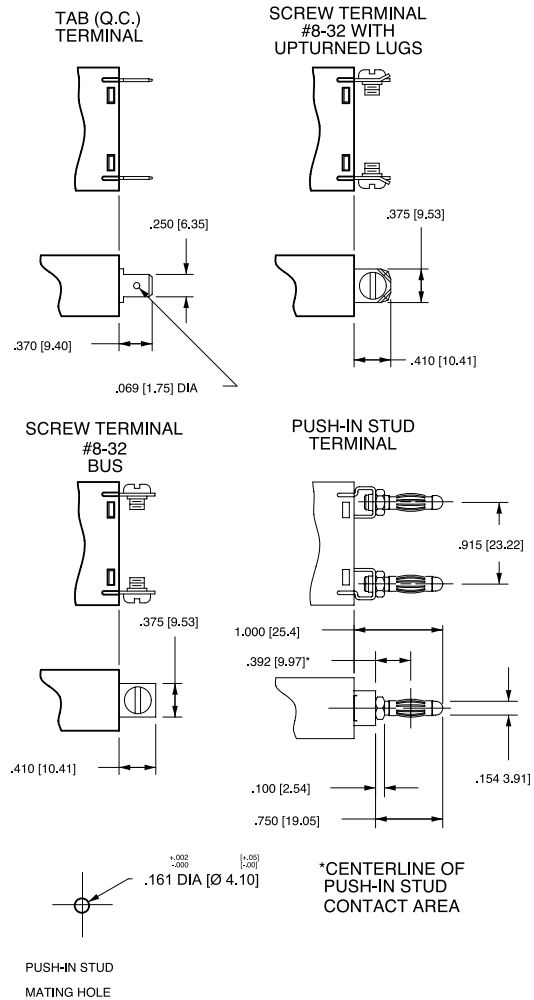

FIG. B

Notes:

- All dimensions are in inches [millimeters].
- Tolerance ±.020 [.51] unless otherwise specified.

## TERMINAL DIMENSIONAL DETAIL



## AUXILIARY SWITCH TERMINALS

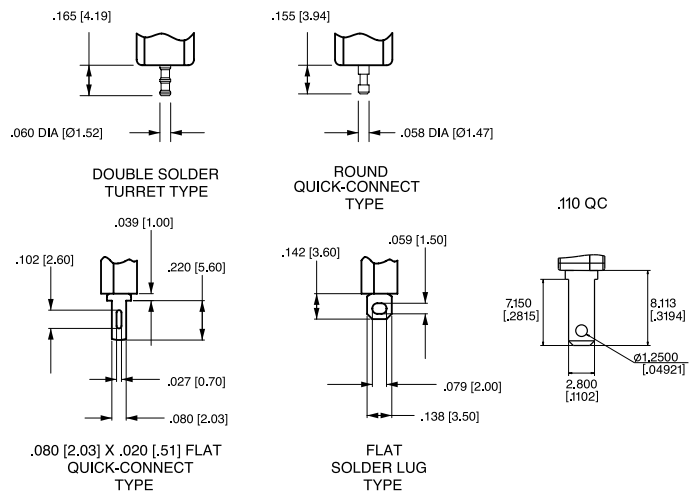

\*AVAILABLE THROUGH SPECIAL CATALOG PART NUMBER

## Dimensional Specifications: in. [mm]

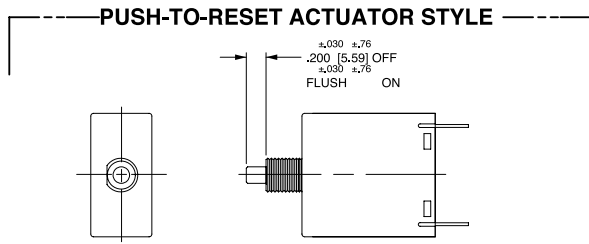
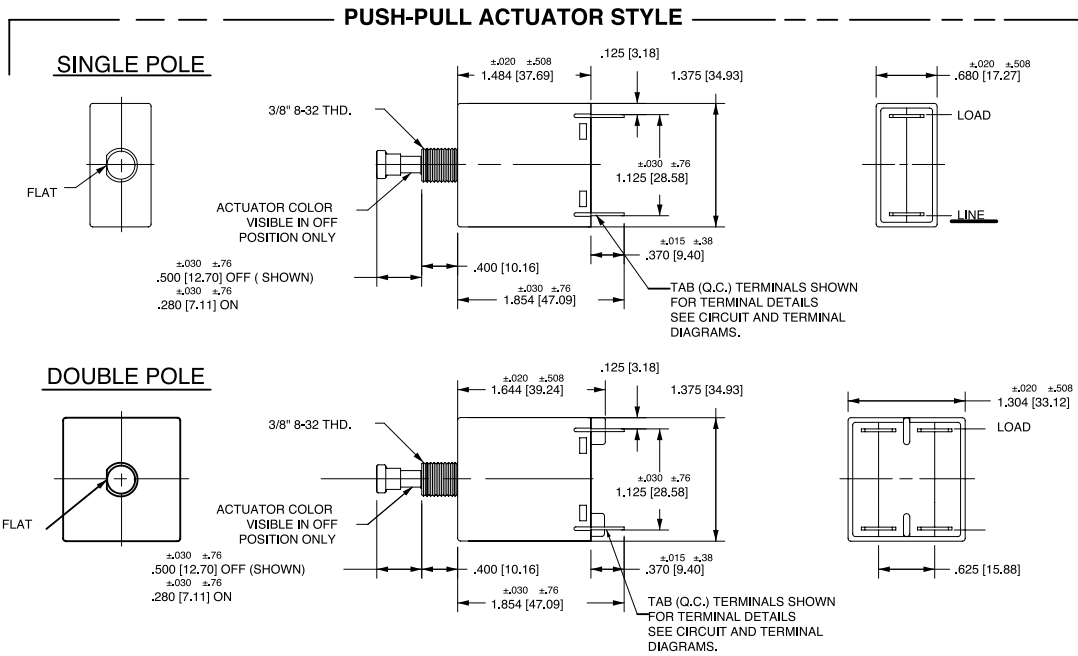

**MOUNTING DETAILS**

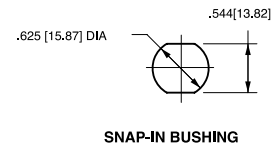
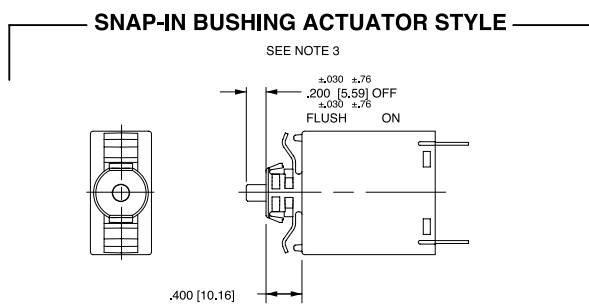
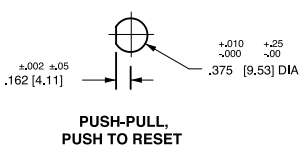

**PANEL HARDWARE**

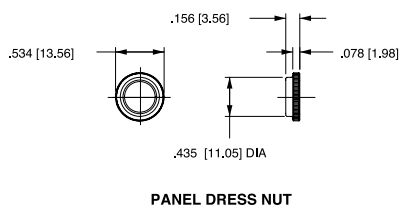

**BUTTON MARKING ORIENTATION (PUSH-PULL ONLY)**

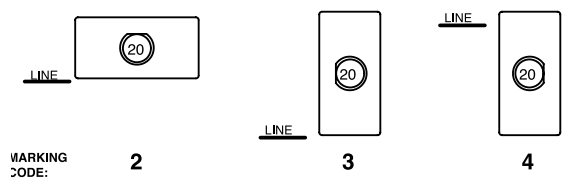

Notes:  
 1 All dimensions are in inches [millimeters].  
 2 Tolerance ± 0.20 [5.1] unless otherwise specified.  
 3 Available with Push-Pull or Push-to-Reset Actuators



## PC Terminal Diagrams: in. [mm]

### PUSH-PULLTYPE SHOWN WITHOUT AUX. SWITCH

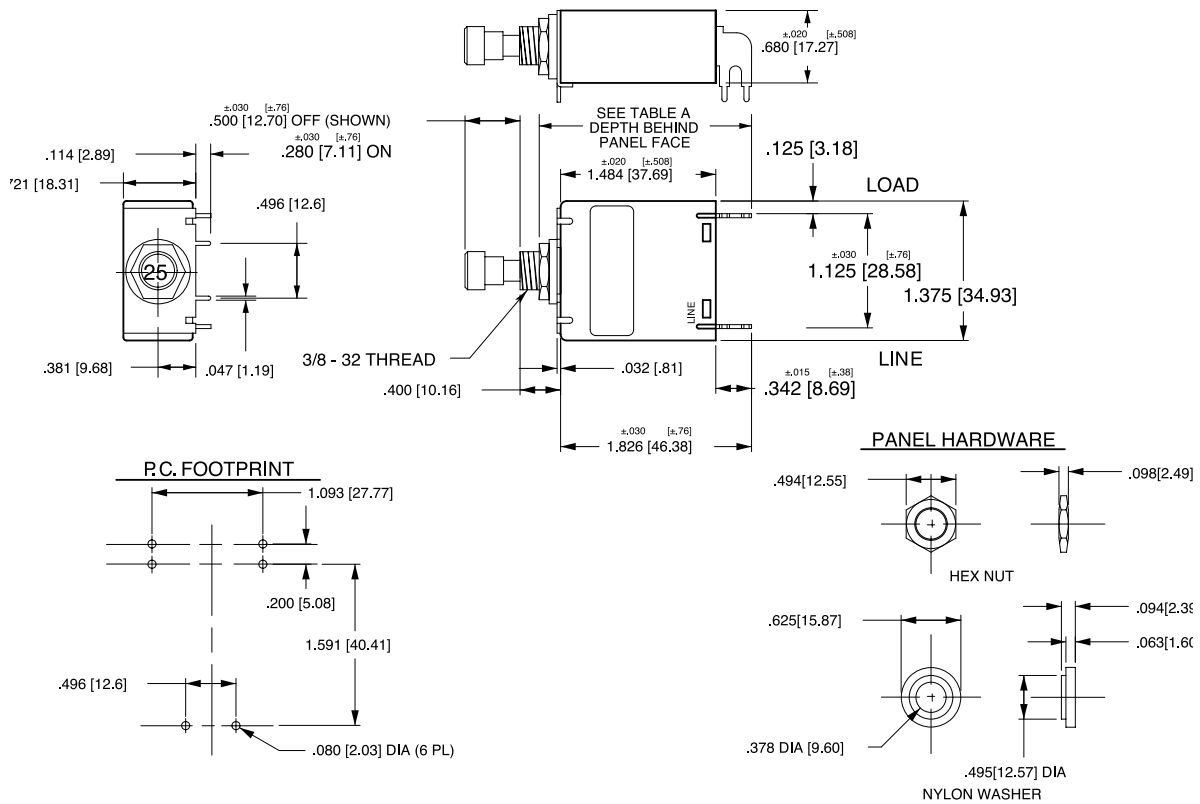

### PUSH PULL TYPE SHOWN WITH AUX. SWITCH

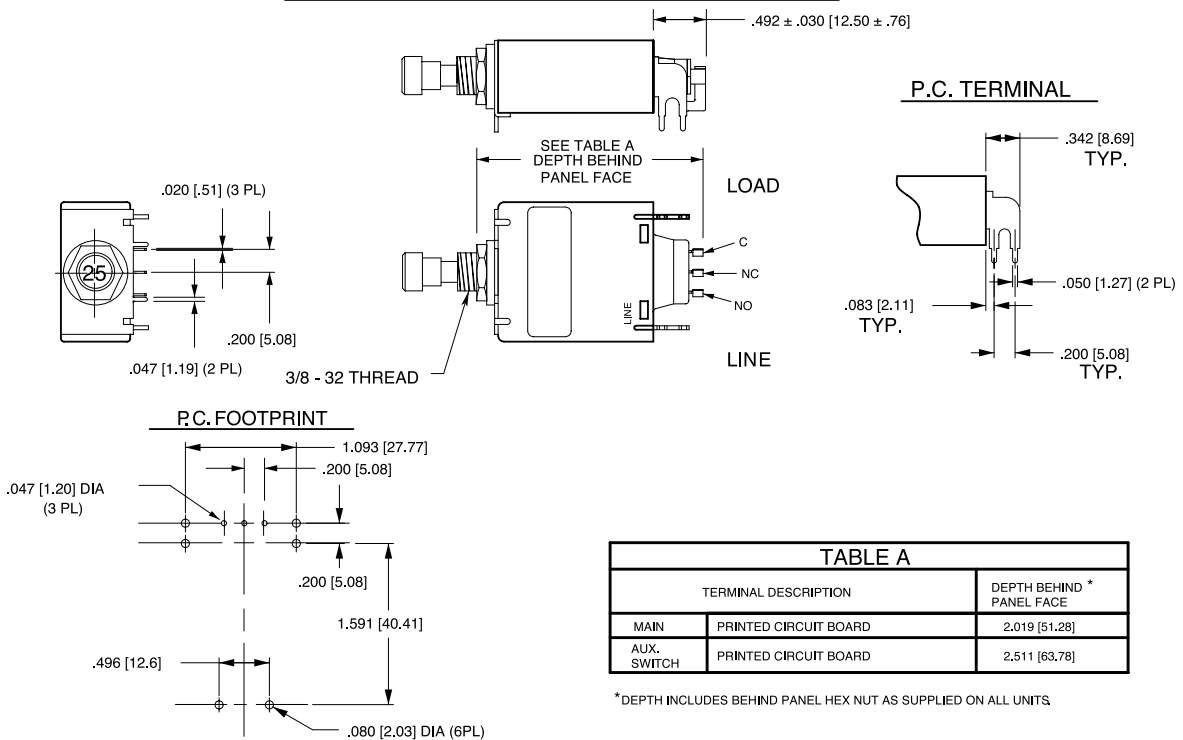
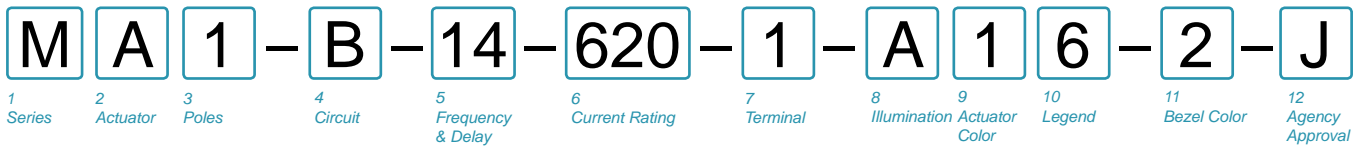

TABLE A		
TERMINAL DESCRIPTION		DEPTH BEHIND * PANEL FACE
MAIN	PRINTED CIRCUIT BOARD	2,019 [51.28]
AUX. SWITCH	PRINTED CIRCUIT BOARD	2,511 [63.78]

\*DEPTH INCLUDES BEHIND PANEL HEX NUT AS SUPPLIED ON ALL UNITS.

Notes:

- 1 All dimensions are in inches [millimeters].
- 2 Tolerance  $\pm 0.020$  [51] unless otherwise specified.



**1 SERIES**  
M

**2 ACTUATOR 1**

**Non-Illuminated single color**  
**A** Angled  
**B** Flat

**Two Color Visi-Rocker**  
**D** Indicate ON  
**E** Indicate OFF

**illuminated single color**  
**F** Angled  
**G** Flat

STYLE	INDICATE "ON" (CODES A, D)	INDICATE "OFF" (CODES B, E)	FLAT (CODES B, G)	ANGLED (CODES A, F)
VERTICAL				
HORIZONTAL				

**3 POLES**  
1 One

**4 CIRCUIT 2**

**without Auxiliary Switch**  
**B** Series Trip (Current)

**with Auxiliary Switch, Silver Contacts**  
**M** Series Trip (Current) Aux Switch  
**S** 3 Series Trip (Current)  
**T** 3,4 Series Trip (Current)  
**U** 3,16 Series Trip, Maintained Contacts

**with Auxiliary Switch, Gold Contacts**  
**4** 3,4 Series Trip (Current)  
**5** 3,16 Series Trip, Maintained Contacts  
**9** Series Trip (Current) Aux Switch

**Terminal Type:**  
 .110 QC x .020 QC  
 .060 Dia, Round Solder Turret  
 .058 Dia, Round Q.C.  
 .080 Dia x .020 Flat Q.C.

5 FREQUENCY & DELAY	14	DC Medium
10 DC Instantaneous	72	DC, Short, Hi-Inrush
12 DC Short	74	DC, Medium, Hi-Inrush

**6 CURRENT RATING (AMPERES)**

CODE	AMPERES				
020	0.020	225	0.250	420	2.000
025	0.025	230	0.300	522	2.250
030	0.030	235	0.350	425	2.500
035	0.035	240	0.400	527	2.750
040	0.040	245	0.450	430	3.000
045	0.045	250	0.500	435	3.500
050	0.050	255	0.550	440	4.000
055	0.055	260	0.600	445	4.500
060	0.060	265	0.650	450	5.000
065	0.065	270	0.700	455	5.500
070	0.070	275	0.750	460	6.000
075	0.075	280	0.800	465	6.500
080	0.080	285	0.850	470	7.000
085	0.085	290	0.900	475	7.500
090	0.090	295	0.950	480	8.000
090	0.095	410	1.000	485	8.500
210	0.100	512	1.250	490	9.000
215	0.150	415	1.500	495	9.500
220	0.200	517	1.750	610	10.000

- Notes:
- One actuator is located in the center of each multi-pole breaker.
  - One Auxiliary Switch is supplied per breaker. Auxiliary Switch option limited to Series Trip & Switch Only circuits, and is not available in single pole illuminated breakers, or with Back Connected Screw or Push-in Stud terminals.
  - Mates with AMP .058" diameter pin receptacles: 60983-1 (gold plated) & 60983-1 (tin plated).
  - For neon bulb applications at 120VAC @ 47K, 1/4 WATT and for 250VAC applications @ 150K, 1/4 WATT, external resistors must be supplied by customer.
  - For LED (DC or rectified AC) applications, LED is mounted in the center of the rocker actuator with electrical characteristics as follows: 100 millicandela at 20mA; Maximum power dissipation = 75mW at 25°C; Maximum forward current = 25mA; Typical forward voltage = 2.1V at 20mA; Typical reverse current = 100uA at 3V. Customer supplies the proper external resistor limiting current to these values.
  - On Visi-Rocker breakers, Visi portion of rocker cannot be the same color as the bezel.
  - Rocker color for LED's and green neon lamp must be clear, smoke gray, white translucent or match color of LED or neon lamp.
  - Other colors available. Consult factory.
  - TUV Certified to 25 amps. UL Recognized, CSA Accepted and UL489A Listed to 30 amps. Screw Terminals recommended above 20 amps.
  - UL489A Listed must have ON-OFF or Dual legends. TUV Certified approvals must have I - O or Dual legends.
  - Terminal code A available with circuit codes A & B only.
  - Printed circuit board available with UL recognized approval only.
  - Auxiliary switch (flat Q.C.) available with UL recognized approvals only.

**7 TERMINAL**

1 Push-On 0.250 Tab (Q.C.)	A 11 Push-In Stud
2 Screw 8-32 with Upturned Lugs	P 12 Printed Circuit Board
3 Screw 8-32 (Bus Type)	

**8 ROCKER ILLUMINATION**

**Non-illuminated Neon 4**  
 without resistor, 120VAC/250VAC LED 7, 8  
 without resistor  
 with resistor, 4-8 VDC  
 with resistor, 9-16 VDC

A Neon	Green Glow 8
B Red	Green
D Green	Amber
E Amber	K
F Smoke Gray	L
J White	M

**9 ACTUATOR & LEGEND COLOR**

Solid Color	Actuator	Legend
1	White	Black
2	Black	White
3	Red	White
4	Green	White
5	Blue	White
6	Yellow	Black
7	Gray	Black
8	Orange	Black

**Visi-Rocker 6** Visi & Legend (remainder of rocker same color as bezel)

1	White
2	Black
3	Red
4	Green
5	Blue
6	Yellow
7	Gray
8	Orange

**Illuminated 7**

Actuator	Legend
A Clear	White
B Red Transparent	White
C Green Transparent	White
D Amber Transparent	White
E Smoke Gray Transparent	White
F White Translucent	Black

**10 LEGEND 10**

1	No Legend (Single Color or Illuminated Rocker Options Only)
2	ON - OFF Vertical
3	ON - OFF Horizontal
4	I - O Vertical
5	I - O Horizontal
6	Dual Vertical
7	Dual Horizontal

**11 BEZEL COLOR / STYLE 8**

Color	without Rockerguard	with Rockerguard
White	A	1
Black	B	2
Gray	G	7

**12 AGENCY APPROVAL 9**

J	UL489A Listed & TUV Certified
M	UL Recognized & CSA Accepted
N	TUV Certified, UL Recognized & CSA Accepted
T	UL489A Listed

## Circuit & Terminal Diagrams: in. [mm]

### SERIES TRIP

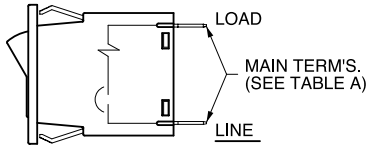

### SERIES TRIP W/ ILLUMINATED ROCKER

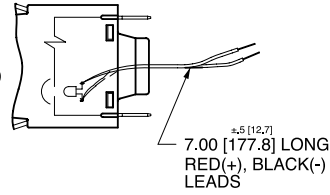

### SWITCH ONLY

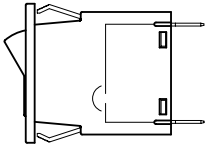

### SWITCH ONLY W/ ILLUMINATED ROCKER

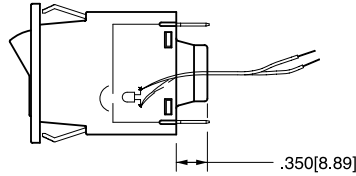

### SERIES TRIP W/ AUXILIARY SWITCH

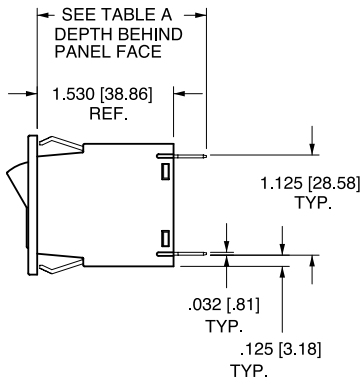
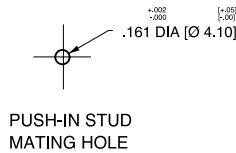
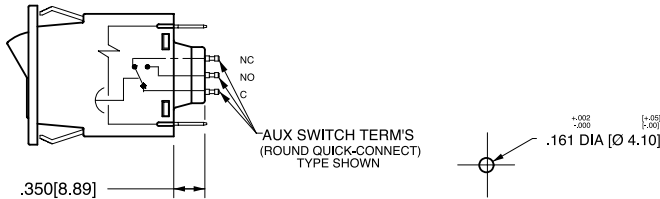

### TERMINAL DIMENSIONAL DETAIL

#### TAB (Q.C.) TERMINAL

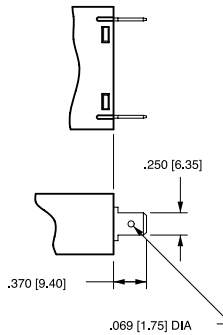

#### SCREW TERMINAL #8-32 WITH UPTURNED LUGS

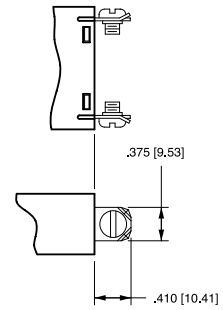

#### SCREW TERMINAL #8-32 BUS

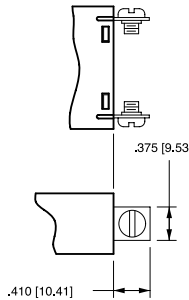

#### PUSH-IN STUD TERMINAL

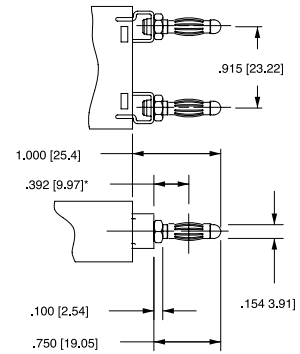

\*CENTERLINE OF  
PUSH-IN STUD  
CONTACT AREA

### AUXILIARY SWITCH TERMINALS

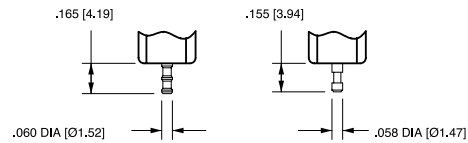

#### DOUBLE SOLDER TURRET TYPE

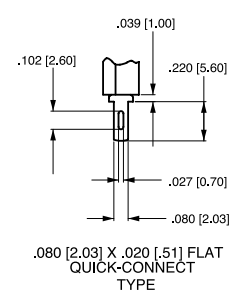

#### ROUND QUICK-CONNECT TYPE

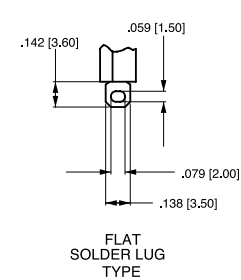

#### .110 QC

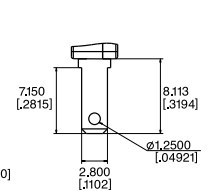

\*AVAILABLE THROUGH SPECIAL  
CATALOG PART NUMBER

TABLE - A		
TERMINAL DESCRIPTION		DEPTH BEHIND PANEL FACE
MAIN	TAB (Q.C.)	1.900 [48.26]
	SCREW (#8-32)**	1.940 [49.28]
	PUSH-IN STUD	2.530 [64.26]
*AUX. SWITCH	DOUBLE SOLDER TURRET TYPE	2.045 [51.94]
	ROUND Q.C. TYPE	2.035 [51.69]
	FLAT QUICK CONNECT	2.139 [54.33]
	FLAT SOLDER LUG	2.022 [51.36]

\* AUX. SWITCH IS NOT AVAILABLE ON SINGLE POLE ILLUMINATED UNITS. WHEN CALLED FOR ON MULTI-POLE UNITS, ONLY ONE AUX. SWITCH IS NORMALLY SUPPLIED, MOUNTED AS SHOWN ON CLA-8003.

\*\* RECOMMENDED TIGHTENING TORQUE 12-15 IN LBS [1.4-2.7 NM]

Notes:

- All dimensions are in inches [millimeters].
- Tolerance  $\pm 0.02$  [.51] unless otherwise specified.
- Schematic shown represents current trip circuit.

## Dimensional Specifications: in. [mm]

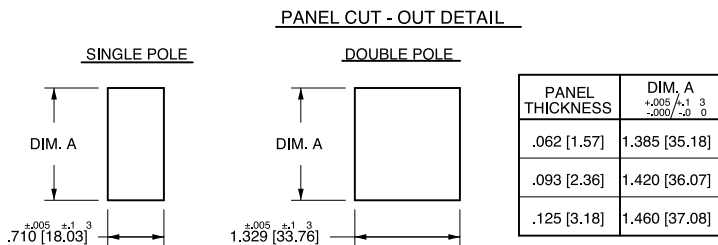
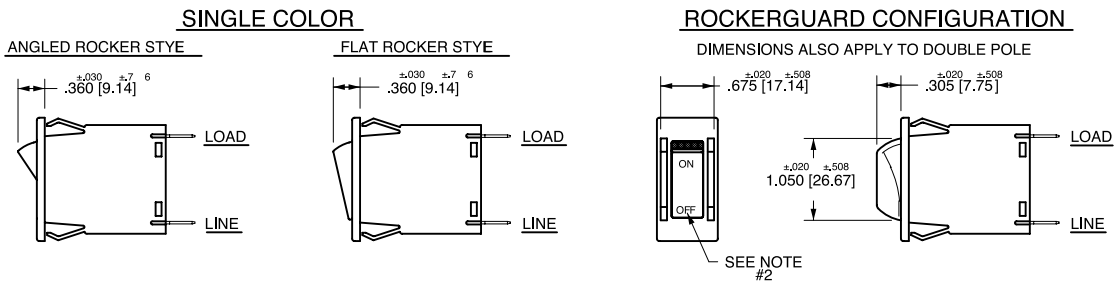
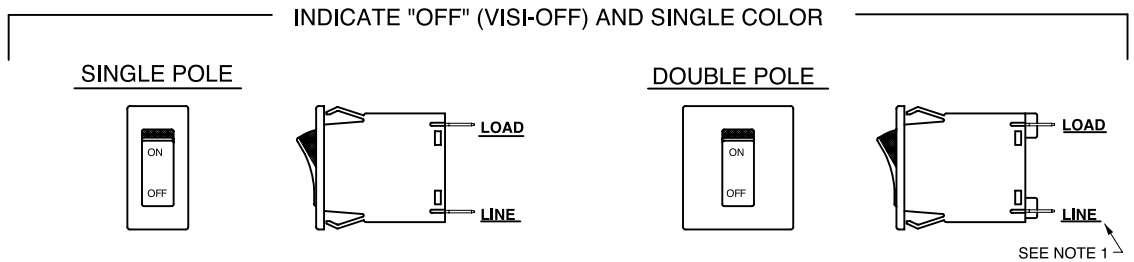
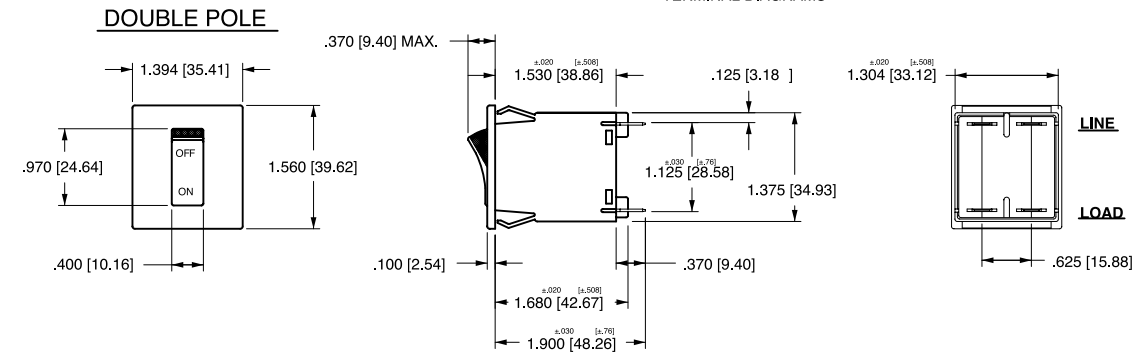
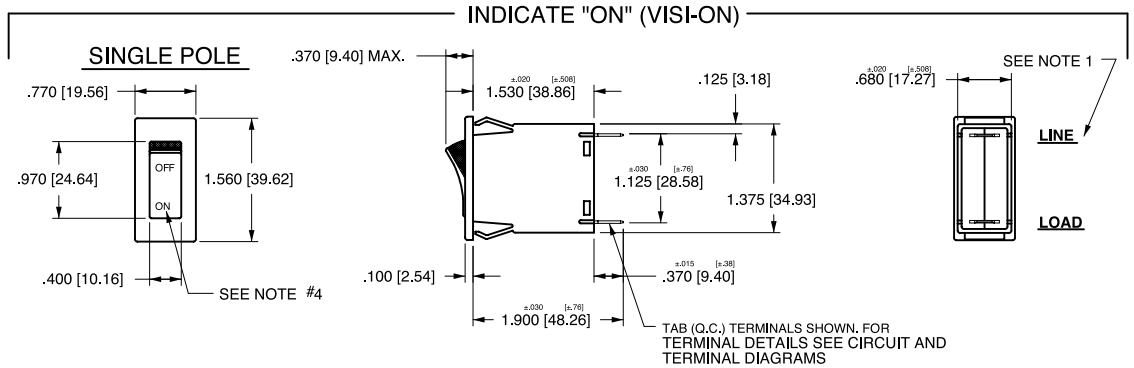

- Notes:
- Dimensions apply to all variations shown. Notice that circuit breaker line & load terminal orientation on indicate OFF is opposite of indicate ON.
  - I-O, ON-OFF or dual legends available for vertical or horizontal mounting. For pole orientation with horizontal legend, rotate front view clockwise 90°.
  - All dimensions are in inches [millimeters].
  - Tolerance ± 0.20 [51] unless otherwise specified.

**ONE POLE**

**SINGLE POLE / ROCKER BREAKERS SHOWN WITH DOUBLE SOLDER TURRET AND ROUND QC AUX. SWITCH TERMINALS**

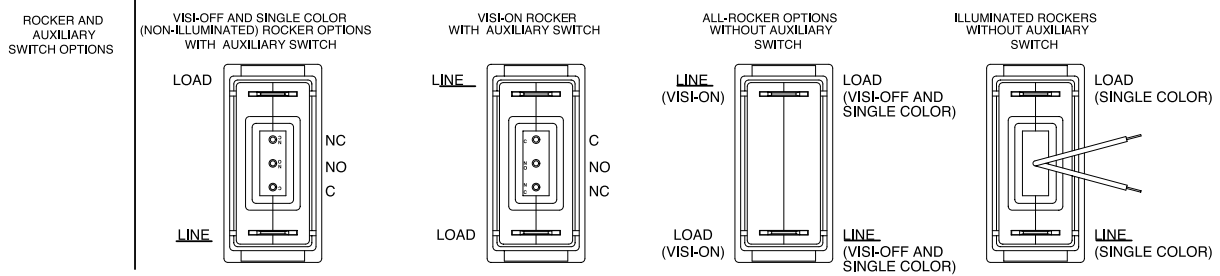

**SINGLE POLE / ROCKER BREAKERS SHOWN WITH FLAT QC AND FLAT SOLDER LUG AUX. SWITCH TERMINALS**

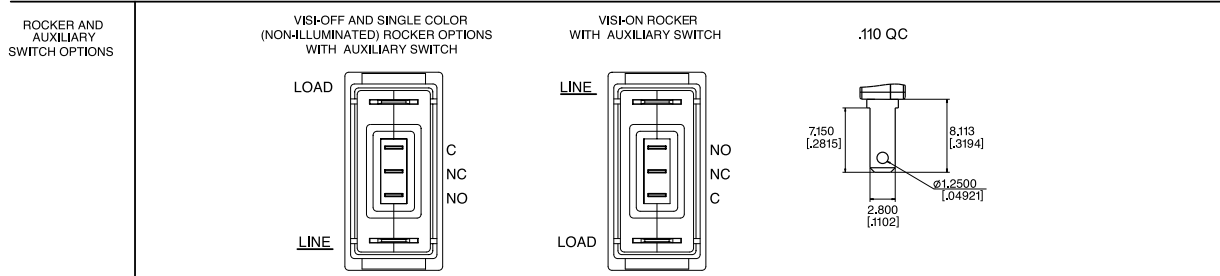

**TWO POLE**

**DOUBLE POLE / ROCKER BREAKERS SHOWN WITH DOUBLE SOLDER TURRET AND ROUND QC AUX. SWITCH TERMINALS**

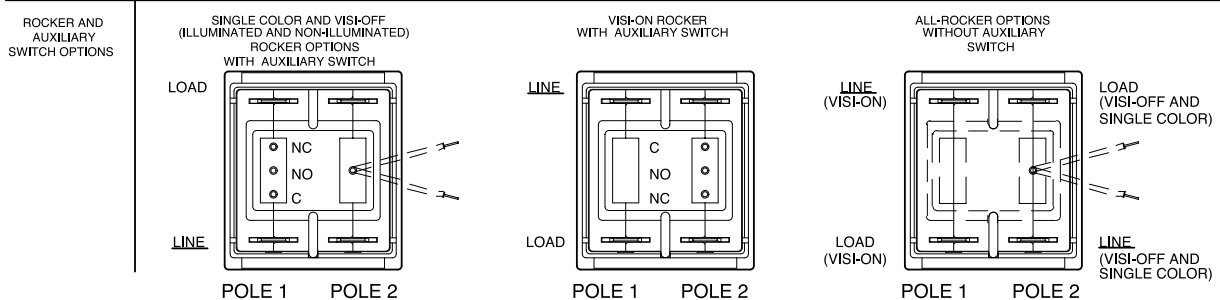

**DOUBLE POLE / ROCKER BREAKERS SHOWN WITH FLAT QC AND FLAT SOLDER LUG AUX. SWITCH TERMINALS**

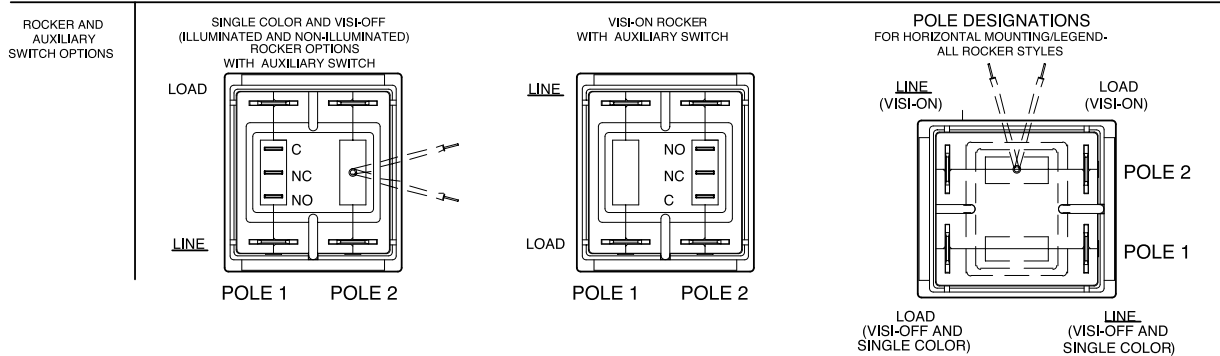

# A-Series

## CIRCUIT BREAKER

Well known for their proven reliability, Carling Technologies' A-Series hydraulic magnetic circuit breakers are compact, temperature stable and designed for precision operation in OEM markets requiring general purpose as well as full load amp applications. When front panel operation and aesthetics demand a clean, contemporary design, the visi-rocker or paddle actuators are ideally suitable. A sealed toggle actuator style is also available and ideal for harsh environment applications requiring additional sealing protection. Optional rocker-guard and push-to-reset bezels, which help prevent inadvertent actuation, are also available.

1-6 poles; ratings from 0.02 to 50 amps, up to 277VAC or 80VDC; UL Recognized, UL Listed, UL1500, UL1077, TUV, VDE & CSA



### Product Highlights:

- ◆ Up to 50 amps in a compact size
- ◆ Various actuator styles
- ◆ Sealed metal toggle option tested to MIL-PRF-55629C. Meets IP68 Requirements

Only Telecom-Datcom applicable ordering schemes and drawings are shown in this catalog. For complete product details, please visit [www.carlingtech.com](http://www.carlingtech.com)

**Electrical**

Maximum Voltage 277VAC 50/60 Hz, 80VDC  
 Current Ratings Standard current coils: 0.100, 0.250, 0.500, 0.750, 1.00, 2.50, 5.00, 7.50, 10.0, 15.0, 20.0, 25.0, 30.0, 35.0, 40.0, 50.0. Other ratings available - consult ordering scheme.  
 Standard Voltage Coils DC-6V, 12V; AC-120V, Other ratings available, consult ordering scheme.  
 Auxiliary Switch Rating SPDT; 10.1 A - 250VAC, 1.0 A-65VDC/0.5 A - 80 VDC, 0.1A - 125VAC (with gold contacts).  
 Insulation Resistance Minimum: 100 Megohms at 500 VDC  
 Dielectric Strength UL, CSA - 1500V 60 Hz for one minute between all electrically isolated terminals. A-Series rocker circuit breakers comply with the 8mm spacing & 3750V dielectric requirements from hazardous voltage to operator accessible surfaces per EN 60950 and VDE 0805.  
 Resistance, Impedance Values from Line to Load Terminal - based on Series Trip Circuit Breaker.

**Mechanical**

Endurance 10,000 ON-OFF operations @ 6 per minute; with rated Current & Voltage.  
 Trip Free All A-Series Circuit Breakers will trip on overload, even when the actuator is forcibly held in the ON position.  
 Trip Indication The operating actuator moves positively to the OFF position when an overload causes the circuit breaker to trip. When mid-trip handle is specified, the handle moves to the mid position on electrical trip of the circuit breaker. When mid-trip handle with alarm switch is specified, the handle moves to the mid position & the alarm switch actuates when the circuit breaker is electrically tripped.

**Physical**

Number of Poles 1 - 6 Poles (handle) and 1-3 poles (rocker) at 30 Amps or less. 1 and 2 poles at 31 Amps thru 50 Amps.  
 Internal Circuit Config. Series, (with or without auxiliary switch), Shunt and Relay with current or voltage trip coils, Dual Coil, Switch Only with or without auxiliary switch.  
 Weight Approximately 65 grams/pole. (Approximately 2.32 ounces/pole)  
 Standard Colors Housing - Black; Actuator- See Ordering Scheme.

**Environmental**

Designed and tested in accordance with requirements of specification MIL-PRF-55629 & MIL-STD-202 as follows:  
 Shock Withstands 100 Gs, 6ms, sawtooth while carrying rated current per Method 213, Test Condition "I". Instantaneous and ultra-short curves tested @ 90% of rated current.  
 Vibration Withstands 0.060" excursion from 10-55 Hz, and 10 Gs 55-500 Hz, at rated current per Method 204C, Test Condition A. Instantaneous and ultrashort curves tested at 90% of rated current.  
 Moisture Resistance Method 106D; ten 24-hour cycles @ + 25°C to +65°C, 80-98% RH.56 days @ +85°C, 85% RH.  
 Salt Spray Method 101, Condition A (90-95% RH @ 5% NaCl Solution, 96 hrs).  
 Thermal Shock Method 107D, Condition A (Five cycles @ -55°C to +25°C to +85°C to +25°C).  
 Operating Temperature -40° C to +85° C

RESISTANCE PER POLE VALUES from Line to Load Terminals (Values Based on Series Trip Circuit Breaker)

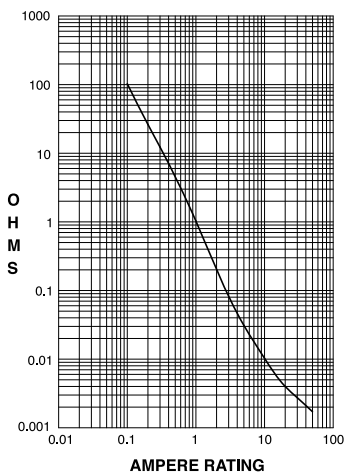

CURRENT (AMPS)	TOLERANCE (%)
0.10 - 5.0	15
5.1 - 20.0	25
20.1 - 50.0	35

Pulse Tolerance Curves

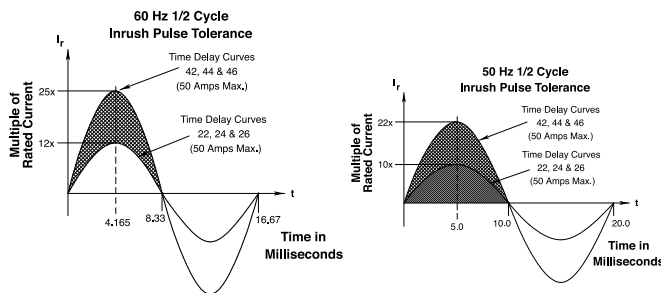

\*Manufacturer reserves the right to change product specification without prior notice.

Electrical Tables

Table A: Lists UL Recognized & CSA Accepted configurations and performance capabilities as a Component Supplementary Protector.

A-SERIES TABLE A: COMPONENT SUPPLEMENTARY PROTECTORS											
Circuit Configuration	Voltage			Current Rating		Short Circuit Capacity (Amps)		Application Codes		Construction Notes	
	Max Rating	Frequency	Phase	Full Load Amps	General Purpose Amps	UL / CSA		UL	CSA		
						With Backup Fuse	Without Backup Fuse				
Series	32	DC	---	0.02 - 15	---	---	5000	TC1, OL1, U2	TC1, OL1, U2		
	65	DC	---	31 - 50	---	---	7500	TC1, 2, OL1, U1	TC1, 2, OL1, U1		
	80	DC	---	0.02 - 30	---	---	7500	TC1, 2, OL1, U1	TC1, 2, OL1, U1		
				---	31 - 50	---	7500	TC1, 2, OL0, U1	TC1, 2, OL0, U1		
	125	50 / 60	1	0.02 - 30	---	---	3000	TC1, OL1, U2	TC1, OL1, U2	Rocker Version	
	125	50 / 60	1	1 - 50	---	---	2000	TC1, OL1, U2	TC1, OL1, U2		
	125	50 / 60	1 <sup>4</sup>	1 - 50	---	---	1000	TC1, OL1, U2	TC3, OL1, U3		
	125 / 250	50 / 60	1 <sup>3</sup>	0.02 - 30	---	---	3000	TC1, 2, OL1, U2	TC1, 2, OL1, U2	Rocker Version	
	125 / 250	50 / 60	1 <sup>3</sup>	0.02 - 50	---	---	3000	TC1, 2, OL1, U2	TC1, 2, OL1, U2	Handle	
	250	50 / 60	1	0.02 - 30	---	---	1500	TC1, 2, OL0, U2	TC1, 2, OL0, U2	Single Pole Break	
				0.02 - 30	---	---	3000	TC1, OL1, U2	TC1, OL1, U2	Two Pole Break	
				---	---	---	3000	TC1, 2, OL0, U1	TC1, 2, OL0, U1		
				1 <sup>4</sup>	1 - 50	---	---	1000	TC1, OL1, U2	TC3, OL1, U3	
				3	0.02 - 30	---	5000 <sup>2</sup>	---	---	TC1, 2, OL1, C1	TC1, 2, OL1, C1
3				31 - 50	---	2000 <sup>1</sup>	---	---	TC1, 2, OL1, C1	TC1, 2, OL1, C1	
277	50 / 60	1	0.02 - 30	---	---	5000 <sup>1</sup>	---	TC1, 2, OL1, C1	TC1, 2, OL1, C1		
Dual Coil	32	DC	---	0.02 - 50	---	---	5000	TC1, OL1, U2	TC1, OL1, U2		
	65	DC	---	0.02 - 50	---	---	7500	TC1, 2, OL1, U1	TC1, 2, OL1, U1		
	80	DC	---	0.02 - 30	---	---	7500	TC1, 2, OL1, U1	TC1, 2, OL1, U1		
				---	31 - 50	---	7500	TC1, 2, OL0, U1	TC1, 2, OL0, U1		
	125	50 / 60	1	0.02 - 30	---	---	3000	TC1, OL1, U2	TC1, OL1, U2	Rocker Version	
				1 - 50	---	---	2000	TC1, OL1, U2	TC1, OL1, U2		
	125	50 / 60	1 <sup>4</sup>	0.02 - 30	---	---	1000	TC1, OL1, U2	TC3, OL1, U3		
	125 / 250	50 / 60	1 <sup>3</sup>	0.02 - 30	---	---	3000	TC1, 2, OL1, U1	TC1, 2, OL1, U1	Rocker Version	
	125 / 250	50 / 60	1 <sup>3</sup>	0.02 - 50	---	---	3000	TC1, 2, OL1, U2	TC1, 2, OL1, U2		
	250	50 / 60	1	0.02 - 30	---	---	1500	TC1, OL0, U2	TC1, OL0, U2	Single Pole Break	
				0.02 - 30	---	---	3000	TC1, OL1, U2	TC1, OL1, U2	Two Pole Break	
				---	31 - 50	---	---	3000	TC1, 2, OL0, U1	TC1, 2, OL0, U1	
				1 <sup>4</sup>	1 - 50	---	---	1000	TC1, OL1, U2	TC3, OL1, U3	
				3	0.02 - 30	---	5000 <sup>2</sup>	---	---	TC1, 2, OL1, C1	TC1, 2, OL1, C1
3				31 - 50	---	2000 <sup>1</sup>	---	---	TC1, 2, OL1, C1	TC1, 2, OL1, C1	
277	50 / 60	1	0.02 - 30	---	---	5000 <sup>1</sup>	---	TC1, 2, OL1, U1	TC1, 2, OL1, U1		
Shunt	80	DC	---	0.02 - 30	---	---	7500	TC1, 2, OL1, U1	TC1, 2, OL1, U1		
	125 / 250	50 / 60	1	0.02 - 30	---	---	3000	TC1, 2, OL1, U1	TC1, 2, OL1, U1		
	250	50 / 60	1	0.02 - 30	---	---	3000	TC1, 2, OL1, U1	TC1, 2, OL1, U1		
			3	0.02 - 30	---	5000 <sup>2</sup>	---	---	TC1, 2, OL1, C1	TC1, 2, OL1, C1	
	277	50 / 60	1	0.02 - 30	---	---	5000 <sup>1</sup>	---	TC1, 2, OL1, C1	TC1, 2, OL1, C1	
Relay	80	DC	---	0.02 - 30	---	---	7500	TC1, 2, OL1, U1	TC1, 2, OL1, U1		
	125 / 250	50 / 60	1 <sup>3</sup>	0.02 - 30	---	---	3000	TC1, 2, OL1, U1	TC1, 2, OL1, U1		
	250	50 / 60	1	0.02 - 30	---	---	3000	TC1, 2, OL1, U1	TC1, 2, OL1, U1		
			3	0.02 - 30	---	5000 <sup>2</sup>	---	---	TC1, 2, OL1, C1	TC1, 2, OL1, C1	
	277	50 / 60	1	0.02 - 30	---	---	5000 <sup>1</sup>	---	TC1, 2, OL1, C1	TC1, 2, OL1, C1	
Switch Only	65	DC	---	0.02 - 50	---	not applicable					
	80	DC	---	0.02 - 30	---						
	250	50 / 60	1	---	31 - 50						
			3	0.02 - 50	---						
	277	50 / 60	1	0.02 - 30	31 - 50						

Notes:  
 1 Requires branch circuit backup with a UL LISTED Type K5 or RK5 fuse (15A minimum) at no more than 4 times the rating of the protector.  
 2 Same as note 1, except that backup fuse is limited to 80 A maximum.  
 3 2 pole protector required (with one pole per power line) for: 125/250 VAC, 1 pole protector required for: 125 VAC, 1Ø Power System.  
 4 Satisfies the requirements of clause 11.2.8.2.5 of CSA STD C22.2 No 100 for the use of supplementary protectors with portable generators.



## Electrical Tables

**Table B:** Lists UL Recognized, CSA Accepted, VDE & TUV Certified configurations & performance capabilities as a Component Supplementary Protector.

A-SERIES TABLE B: COMPONENT SUPPLEMENTARY PROTECTORS															
CIRCUIT CONFIGURATION	VOLTAGE			CURRENT RATING		SHORT CIRCUIT CAPACITY (AMPS)						APPLICATION CODES		VDE CONSTRUCTION NOTES	
	MAX. RATING	FREQUENCY	PHASE	FULL LOAD AMPS	GENERAL PURPOSE AMPS <sup>1</sup>	UL/CSA		VDE		TUV		UL	CSA		
						WITH BACKUP FUSE	WITHOUT BACKUP FUSE	(Inc) WITH BACKUP FUSE	(Inc) WITHOUT BACKUP	(Inc) WITH BACKUP FUSE	(Inc) WITHOUT BACKUP				
SERIES	65	DC	—	0.10 - 50	—	—	7500	—	—	5000	3000	TC1,2, OL1,U1	TC1,2, OL1,U1	World Market Breaker TUV Only	
	80	DC	—	0.10 - 30	—	—	7500	3000	1500	3000	1500	TC1,2, OL1,U1	TC1,2, OL1,U1	Handle Version 1 Pole Only	
				31 - 50	31 - 50	—	7500	3000	1500	3000	1500	TC1,2, OL0,U1	TC1,2, OL0,U1	Handle Version 1 Pole Only	
				0.10 - 30	—	—	7500	3000	1500	3000	1500	TC1,2, OL1,U1	TC1,2, OL1,U1	Rocker Version 1 - 3 Poles	
				31 - 32	—	—	7500	3000	1500	3000	1500	TC1,2, OL1,U1	TC1,2, OL1,U1	Rocker Version 2 Pole Only	
				31 - 50	31 - 50	—	7500	3000	1500	3000	1500	TC1,2, OL0,U1	TC1,2, OL0,U1	Rocker Version 1 Pole Only	
	250	50 / 60	1	0.10 - 30	—	—	3000	3000	1500	5000	1500	TC1,2, OL1,U1	TC1,2, OL1,U1	Rocker Version 1 - 3 Poles	
				31 - 50	31 - 50	—	3000	—	—	5000	1500	TC1,2, OL0,U1	TC1,2, OL0,U1	Rocker Version 1 - 3 Poles	
				31 - 32	—	—	3000	6000	1500	5000	1500	TC1,2, OL1,U1	TC1,2, OL1,U1	Rocker Version 2 Pole Only	
			1	0.10 - 30	—	—	3000	6000	1500	5000	1500	TC1, OL1,U2	TC1, OL1,U2	Rocker Version 2 Pole Only	
			1 <sup>4</sup>	1 - 50	—	—	1000	—	—	5000	1500	TC1, OL1,U2	TC3, OL1,U3	Rocker Version 1 - 3 Poles	
			3	0.10 - 30	—	—	5000 <sup>3</sup>	—	3000	1500	3000	1500	TC1,2, OL1,C1	TC1,2, OL1,C1	Rocker Version 1 - 3 Poles
			31 - 50	—	—	2000 <sup>2</sup>	—	3000	1500	3000	1500	TC1,2, OL1,C1	TC1,2, OL1,C1	Rocker Version 1 - 3 Poles	
	DUAL COIL	80	DC	—	0.10 - 30	—	—	7500	3000	1500	3000	1500	TC1,2, OL1,U1	TC1,2, OL1,U1	Rocker Version 1 - 3 Poles
		250	50 / 60	1	0.10 - 30	—	—	3000	3000	1500	5000	1500	TC1,2, OL1,U1	TC1,2, OL1,U1	Rocker Version 1 - 3 Poles
30 - 50					31 - 50	—	3000	—	—	5000	1500	TC1,2, OL0,U1	TC1,2, OL0,U1	Rocker Version 1 - 3 Poles	
3				0.10 - 30	—	—	5000 <sup>3</sup>	—	3000	1500	3000	1500	TC1,2, OL1,C1	TC1,2, OL1,C1	Rocker Version 1 - 3 Poles
				31 - 50	—	—	2000 <sup>2</sup>	—	—	3000	1500	TC1,2, OL1,C1	TC1,2, OL1,C1	Rocker Version 1 - 3 Poles	
SHUNT	80	DC	—	0.10 - 30	—	—	7500	3000	1500	3000	1500	TC1,2, OL1,U1	TC1,2, OL1,U1	Handle Version 1 Pole Only	
				0.10 - 30	—	—	7500	3000	1500	3000	1500	TC1,2, OL1,U1	TC1,2, OL1,U1	Rocker Version 1 - 3 Poles	
	250	50 / 60	1	0.10 - 30	—	—	3000	3000	1500	5000	1500	TC1,2, OL1,U1	TC1,2, OL1,U1	Rocker Version 1 - 3 Poles	
				30 - 50	31 - 50	—	3000	—	—	5000	1500	TC1,2, OL0,U1	TC1,2, OL0,U1	Rocker Version 1 - 3 Poles	
				0.10 - 30	—	—	5000 <sup>3</sup>	—	3000	1500	3000	1500	TC1,2, OL1,C1	TC1,2, OL1,C1	Rocker Version 1 - 3 Poles
			3	0.10 - 30	—	—	5000 <sup>3</sup>	—	3000	1500	3000	1500	TC1,2, OL1,C1	TC1,2, OL1,C1	Rocker Version 1 - 3 Poles
				31 - 50	—	—	2000 <sup>2</sup>	—	—	3000	1500	TC1,2, OL1,C1	TC1,2, OL1,C1	Rocker Version 1 - 3 Poles	

Notes:

- 1 General Purpose Ratings for UL/CSA Only.
- 2 Requires branch circuit backup with a UL LISTED Type K5 or RK5 fuse (15A minimum) at no more than 4 times the rating of the protector.
- 3 Same as note 2, except that backup fuse is limited to 80 A maximum.
- 4 Satisfies the requirements of clause 11.2.8.2.5 of CSA STD C22.2 No 100 for the use of supplementary protectors with portable generators.

## Electrical Tables

**Table C:** Lists UL Recognized, CSA Accepted configurations and performance capabilities as Protectors, Supplementary for Marine Electrical and Fuel Systems (Guide PEQZ2, File E75596). Ignition Protected per UL 1500. UL Classified Small Craft Electrical Devices, Marine in accordance with ISO 8846 (Guide UZMK, File MQ1515) as Marine Supplementary Protectors.

A-SERIES TABLE C: UL1500 (Marine Ignition Protected)							
CIRCUIT CONFIGURATION	VOLTAGE			CURRENT RATING	SHORT CIRCUIT CAPACITY (AMPS)	APPLICATION CODES	
	MAX. RATING	FREQUENCY	PHASE	FULL LOAD AMPS	WITHOUT BACKUP FUSE	UL	CSA
SERIES	14 <sup>1</sup>	DC	---	0.02 - 50	5000	TC1,OL1,U1	TC1,OL1,U1
	32 <sup>1</sup>	DC	---	0.02 - 50	5000	TC1,OL1,U2	TC1,OL1,U2
	65	DC	---	0.02 - 50	3000	TC1,OL1,U1	TC1,OL1,U1
	125	50 / 60	1	0.02 - 50	3000	TC1,OL1,U2	TC1,OL1,U2
	125 / 250	50 / 60	1 <sup>2</sup>	0.02 - 50	3000	TC1,OL1,U2	TC1,OL1,U2
	250	50 / 60	1	0.02 - 30	1500	TC1,OL1,U1	TC1,OL1,U1

Notes:

- 1 Available with special catalog number only (consult factory).
- 2 2 pole protector required (with one per power line) for 125 / 250 VAC. 1 pole protector required for 125 VAC 1 phase power system

**Table D:** Lists UL Listed configurations and performance capabilities as Circuit Breakers for use in Communications Equipment (Guide DITT, File E189195), under UL489A.

A-SERIES TABLE D: UL489A (COMMUNICATIONS EQUIPMENT)				
CIRCUIT CONFIGURATION	VOLTAGE		CURRENT RATING	INTERRUPTING CAPACITY (AMPS)
	MAX. RATING	FREQUENCY	GENERAL PURPOSE AMPS	WITHOUT BACKUP FUSE
SERIES	80	DC	0.10 - 50	5000
	80	DC	60 - 90 <sup>1</sup>	5000

Notes:

- 1 Parallel Pole Construction

## Agency Certifications

### UL Recognized

UL Standard 1077



Component Recognition Program as Protectors Supplementary (Guide CCN/QVNU2, File E75596)

UL Standard 508



Switches, Industrial Control (Guide CCN/NRNT2, File E148683)

UL Standard 1500



Protectors, Supplementary for Marine Electrical & Fuel Systems (Guide PEQZ2, File E75596) Ignition Protection

### UL Listed

UL Standard 489A



Communications Equipment (Guide CCN/DITT, File E189195)

### CSA Accepted



Component Supplementary Protector under Class 3215 30, File 047848 0 000 CSA Standard C22.2 No. 235

### TUV Certified



EN60934, under License No. R72103448

### VDE Certified



EN60934, VDE 0642 under File No. 10537

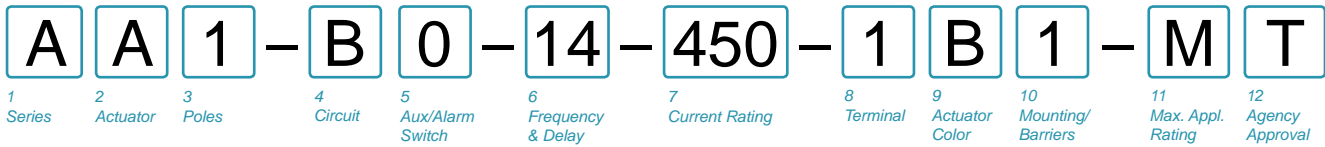

**1 SERIES**  
**A**

**2 ACTUATOR <sup>1</sup>**  
**A** Handle, one per pole  
**S** Mid-Trip Handle, one per pole  
**T** Mid-Trip Handle, one per pole & Alarm Switch

**3 POLES <sup>2</sup>**  
**1** One  
**2** Two  
**3** Three  
**4** Four

**4 CIRCUIT**  
**B** Series Trip (Current)

**5 AUXILIARY/ALARM SWITCH <sup>2</sup>**

<b>0</b> without Aux Switch	<b>7</b> S.P.S.T., 0.110 Q.C. Term. (Gold Contacts)
<b>1</b> S.P.D.T., 0.093 Q.C. Term.	<b>8</b> S.P.S.T., 0.187 Q.C. Term.
<b>2</b> S.P.D.T., 0.110 Q.C. Term.	<b>9</b> S.P.D.T., 0.187 Q.C. Term.

**6 FREQUENCY & DELAY**

<b>11</b> DC Ultra Short	<b>52<sup>3</sup></b> DC, Short, Hi-Inrush
<b>12</b> DC Short	<b>54<sup>3</sup></b> DC, Medium, Hi-Inrush
<b>14</b> DC Medium	<b>56<sup>3</sup></b> DC, Long, Hi-Inrush
<b>16</b> DC Long	

**7 CURRENT RATING (AMPERES)**

CODE	AMPERES				
210	0.100	285	0.850	455	5.500
215	0.150	290	0.900	460	6.000
220	0.200	295	0.950	465	6.500
225	0.250	410	1.000	470	7.000
230	0.300	512	1.250	475	7.500
235	0.350	415	1.500	480	8.000
240	0.400	517	1.750	485	8.500
245	0.450	420	2.000	490	9.000
250	0.500	522	2.250	495	9.500
255	0.550	527	2.750	610	10.000
260	0.600	430	3.000	710	10.500
265	0.650	435	3.500	611	11.000
270	0.700	440	4.000	711	11.500
275	0.750	445	4.500	612	12.000
280	0.800	450	5.000	712	12.500
				613	13.000
				614	14.000
				615	15.000
				616	16.000
				617	17.000
				618	18.000
				620	20.000
				622	22.000
				624	24.000
				625	25.000
				630	30.000
				635 <sup>3</sup>	35.000
				640 <sup>3</sup>	40.000
				645 <sup>3</sup>	45.000
				650 <sup>3</sup>	50.000

**8 TERMINAL <sup>5</sup>**

<b>1<sup>6</sup></b> Push-On 0.250 Tab (Q.C.)	<b>9</b> Screw 10-32 (Bus Type) & 30° bend
<b>2</b> Screw 8-32 with upturned lugs	<b>B</b> Screw M5 with upturned lugs & 30° bend
<b>3<sup>7</sup></b> Screw 8-32 (Bus Type)	<b>F</b> Screw M5 with upturned lugs & 30° bend
<b>4</b> Screw 10-32 with upturned lugs	<b>G</b> Screw M5 (Bus Type) & 30° bend
<b>5<sup>7</sup></b> Screw 10-32 (Bus Type)	<b>H</b> Screw M5 (Bus Type)
<b>6</b> Screw 8-32 with upturned lugs & 30° bend	<b>M<sup>7</sup></b> M6 Threaded Stud
<b>7</b> Screw 8-32 (Bus Type) & 30° bend	<b>P<sup>8</sup></b> Printed Circuit Board Terminals
<b>8</b> Screw 10-32 with upturned lugs & 30° bend	<b>Q<sup>9</sup></b> Push-In Stud

**9 ACTUATOR COLOR & LEGEND**

Actuator Color	ON-OFF	Dual	Legend Color
White	<b>B</b>	<b>1</b>	Black
Black	<b>D</b>	<b>2</b>	White
Red	<b>G</b>	<b>3</b>	White
Green	<b>J</b>	<b>4</b>	White
Blue	<b>L</b>	<b>5</b>	White
Yellow	<b>N</b>	<b>6</b>	Black
Gray	<b>Q</b>	<b>7</b>	Black
Orange	<b>S</b>	<b>8</b>	Black
Black (short handle) <sup>10</sup>	<b>U</b>	<b>9</b>	White

**10 MOUNTING / BARRIERS**

MOUNTING STYLE	BARRIERS
<b>Threaded Insert, 2 per pole</b>	
<b>1</b> 6-32 x 0.195 inches	no
<b>A</b> 6-32 x 0.195 inches	yes
<b>2</b> ISO M3 x 5mm	no
<b>B</b> ISO M3 x 5mm (multipole only)	yes
<b>Front panel Snap-In, 0.75" wide bezel</b>	
<b>5</b> without Handguard	no
<b>6</b> without Handguard (multipole only)	yes
<b>Front panel Snap-In, 0.96" wide bezel</b>	
<b>7</b> without Handguard, 1-pole 0.96" wide; multipole units have .105" bezel overhang on all sides	no
<b>8</b> without Handguard, 1-pole 0.96" wide; (multipole only) .105" bezel overhang on all sides	yes

**11 MAXIMUM APPLICATION RATING**  
**M** 80 DC

**12 AGENCY APPROVAL**  
**T** UL489A Listed  
**K** UL489A Listed, VDE Certified  
**J** UL489A Listed, TUV Certified

- Notes:
- Actuator Code:  
 A: Handle tie pin spacer(s) and retainers provided un-assembled with multi-pole units.  
 S: Handle moves to mid-position only upon electrical trip of the breaker.  
 T: Handle moves to mid-position and alarm switch activates only upon electrical trip of the breaker.
  - On multi-pole breakers, one auxiliary switch is supplied, mounted in the extreme right pole.
  - VDE Certified to 30 amps. UL489A Listed to 50 amps.
  - VDE Certification available with single pole breakers only. UL489A Listing available with one and two pole breakers.
  - Screw Terminals are recommended on ratings greater than 20 amps. Ratings over 30 amps are only available with Terminal Codes 5, 9 G, H, M and Q.
  - Terminal Code 1 (Push-On) available up to 25 amps with VDE Certification and 30 amps with UL489A Listing, but is not recommended over 20 amps.
  - Terminal Codes 3, 5 and H (Bus Type) with VDE, are supplied with Lock Washers, and Terminal Code M (M6 Threaded Stud) with VDE is supplied with Lock and Flat Washers. These breakers are only VDE Certified when the washers are used.
  - Single pole breakers with Terminal Code P (Printed Circuit Board) are available up to 30 amps with VDE Certification and 50 amps with UL489A Listing.
  - Terminal Code Q not available with VDE certification.
  - Single pole only.

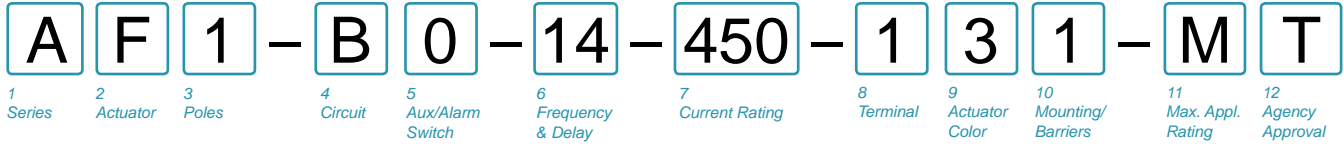

**1 SERIES**  
A

**2 ACTUATOR 1**  
**Two Color Visi-Rocker**  
**C** Indicate ON, vertical legend  
**D** Indicate ON, horizontal legend  
**F** Indicate OFF, vertical legend  
**G** Indicate OFF, horizontal legend  
**Single color**  
**J** Vertical legend  
**K** Horizontal legend  
**Push-To-Reset, Visi-Rocker**  
**N** Indicate OFF, vertical legend  
**O** Indicate OFF, horizontal legend  
**Push-To-Reset, Single color**  
**R** Vertical legend  
**U** Horizontal legend

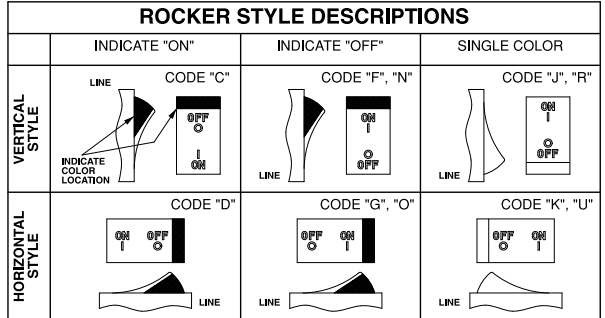

**3 POLES 2**  
**1** One  
**2** Two  
**3** Three

**4 CIRCUIT**  
**B** Series Trip (Current)

**5 AUXILIARY / ALARM SWITCH 2**  
**0** without Aux Switch  
**1** S.P.D.T., 0.093 Q.C. Term.  
**2** S.P.D.T., 0.110 Q.C. Term.  
**7** S.P.S.T., 0.110 Q.C. Term. (Gold Contacts)  
**8** S.P.S.T., 0.187 Q.C. Term.  
**9** S.P.D.T., 0.187 Q.C. Term.

**6 FREQUENCY & DELAY**  
**11** DC Ultra Short  
**12** DC Short  
**14** DC Medium  
**16** DC Long  
**52** DC, Short, Hi-Inrush  
**54** DC, Medium, Hi-Inrush  
**56** DC, Long, Hi-Inrush

**7 CURRENT RATING (AMPERES)**

CODE	AMPERES	285	0.850	455	5.500	613	13.000
210	0.100	285	0.850	455	5.500	613	13.000
215	0.150	290	0.900	460	6.000	614	14.000
220	0.200	295	0.950	465	6.500	615	15.000
225	0.250	410	1.000	470	7.000	616	16.000
230	0.300	512	1.250	475	7.500	617	17.000
235	0.350	415	1.500	480	8.000	618	18.000
240	0.400	517	1.750	485	8.500	620	20.000
245	0.450	420	2.000	490	9.000	622	22.000
250	0.500	522	2.250	495	9.500	624	24.000
255	0.550	527	2.750	610	10.000	625	25.000
260	0.600	430	3.000	710	10.500	630	30.000
265	0.650	435	3.500	611	11.000	635	35.000
270	0.700	440	4.000	711	11.500	640	40.000
275	0.750	445	4.500	612	12.000	645	45.000
280	0.800	450	5.000	712	12.500	650	50.000

**8 TERMINAL 5**  
**1**<sup>6</sup> Push-On 0.250 Tab (Q.C.)  
**2** Screw 8-32 with upturned lugs  
**3**<sup>7</sup> Screw 8-32 (Bus Type)  
**4**<sup>7</sup> Screw 10-32 with upturned lugs  
**5**<sup>7</sup> Screw 10-32 (Bus Type)  
**6** Screw 8-32 with upturned lugs & 30° bend  
**7** Screw 8-32 (Bus Type) & 30° bend  
**8** Screw 10-32 with upturned lugs & 30° bend  
**9** Screw 10-32 (Bus Type) & 30° bend  
**B** Screw M5 with upturned lugs  
**F** Screw M5 with upturned lugs & 30° bend  
**G** Screw M5 (Bus Type) & 30° bend  
**H** Screw M5 (Bus Type)  
**M**<sup>7</sup> M6 Threaded Stud  
**P**<sup>8</sup> Printed Circuit Board Terminals  
**Q**<sup>9</sup> Push-In Stud

**9 ACTUATOR COLOR & LEGEND**

Actuator or Visi-Color <sup>10</sup>	Marking:		Marking Color	
	ON-OFF	Dual <sup>10</sup>	Single Color	Visi-Rocker
White	B	1	Black	White
Black	D	2	White	n/a
Red	G	3	White	Red
Green	J	4	White	Green
Blue	L	5	White	Blue
Yellow	N	6	Black	Yellow
Gray	Q	7	Black	Gray
Orange	S	8	Black	Orange

**10 MOUNTING / BARRIERS 11**

	STANDARD ROCKER BEZEL Threaded Insert, 2 per pole	BARRIERS
<b>1</b>	6-32 x 0.195 inches	no
<b>A</b>	6-32 X 0.195 inches (multi-pole units only)	yes
<b>2</b>	ISO M3 x 5mm	no
<b>B</b>	ISO M3 x 5mm (multi-pole units only)	yes
	<b>ROCKERGUARD &amp; PUSH-TO-RESET BEZEL Threaded Insert, 2 per pole</b>	
<b>3</b>	6-32 x 0.195 inches	no
<b>C</b>	6-32 x 0.195 inches (multi-pole units only)	yes
<b>4</b>	ISO M3 x 5mm	no
<b>D</b>	ISO M3 x 5mm (multi-pole units only)	yes
	<b>FRONT PANEL SNAP-IN BRACKET, 0.744" [18.90mm] wide bezel</b>	
<b>8</b>	without Rockerguard (single pole units only)	no
<b>H</b>	with Rockerguard (single pole units only)	no
	<b>FRONT PANEL SNAP-IN BRACKET, 0.96" [24.48mm] wide bezel</b>	
<b>9</b>	without Rockerguard (single pole units only)	no
<b>J</b>	with Rockerguard (single pole units only)	no

**11 MAXIMUM APPLICATION RATING**  
**M** 80 DC

**12 AGENCY APPROVAL**  
**T** UL489A Listed  
**K** UL489A Listed, VDE Certified  
**J** UL489A Listed, TUV Certified

Notes:  
**1** Push-To-Reset actuators have OFF portion of rocker shrouded.  
**2** Multi-pole breakers have all breakers identical except when specifying Auxiliary switch and/or mixed poles, and have one rocker per breaker.  
**3** Auxiliary Switch breakers with Series Trip circuits: ≤30A, are supplied with standard half shells. 30-50A are supplied with extended boat (B-Style) half shells.  
**4** VDE Certification available with single pole breakers only. UL489A Listing available with one and two pole breakers.  
**5** Screw Terminals are recommended on ratings greater than 20 amps. Ratings over 30 amps are only available with Terminal Codes 5, 9, G, H, M and Q.  
**6** Terminal Code 1 (Push-On) available up to 25 amps with TUV or VDE Certification and 30 amps with UL489A Listing, but is not recommended over 20 amps.  
**7** Terminal Codes 3, 5 and H (Bus Type) with TUV or VDE, are supplied with Lock Washers, and Terminal Code M (M6 Threaded Stud) with VDE is supplied with Lock and Flat Washers. These breakers are only TUV or VDE Certified when the washers are used.  
**8** Single pole breakers with Terminal Code P (Printed Circuit Board) are available up to 30 amps with VDE Certification and 50 amps with UL489A Listing.  
**9** Terminal Code Q not available with VDE certification.  
**10** Color shown is Visi and Legend with remainder of rocker black. Dual = ON-OFF/I-O legend.  
**11** Legend on Push-to-reset bezel/shroud is white with single color actuator codes R & U. Legend on Push-To-Reset bezel/shroud matches Visi-Color of rocker with actuator codes N & O. Rockerguard available with actuator codes C through K

## Circuit & Terminal Diagrams: in. [mm]

CIRCUIT BREAKER PROFILE	CIRCUIT SCHEMATIC		CIRCUIT SCHEMATIC	
	ANSI	CIRCUIT CODE	ANSI	CIRCUIT CODE
<b>2 TERMINALS</b> 	<b>SWITCH ONLY (NO COIL)</b> 	<b>A</b> <b>0</b>	<b>SERIES TRIP</b> 	<b>BC</b> <b>0</b>
<b>5 TERMINALS</b> 	<b>SWITCH ONLY (NO COIL) WITH AUXILIARY SWITCH</b> 	<b>A</b> <b>1</b> <b>2</b> <b>3</b> <b>4</b>	<b>SERIES TRIP WITH (3) AUXILIARY/ALARM SWITCH</b> 	<b>BC</b> <b>1</b> <b>2</b> <b>3</b> <b>4</b>
<b>3 TERMINALS</b> 	<b>SHUNT TRIP</b> 	<b>DE</b> <b>0</b>	<b>DUAL COIL; SERIES TRIP CURRENT COIL, SHUNT TRIP VOLTAGE COIL</b> 	<b>H</b> <b>0</b>
<b>4 TERMINALS</b> 	<b>RELAY TRIP</b> 	<b>FG</b> <b>0</b>	<b>DUAL COIL; SERIES TRIP CURRENT COIL, RELAY TRIP VOLTAGE COIL</b> 	<b>K</b> <b>0</b>

### AUXILIARY/ALARM SWITCH TERMINAL DETAIL

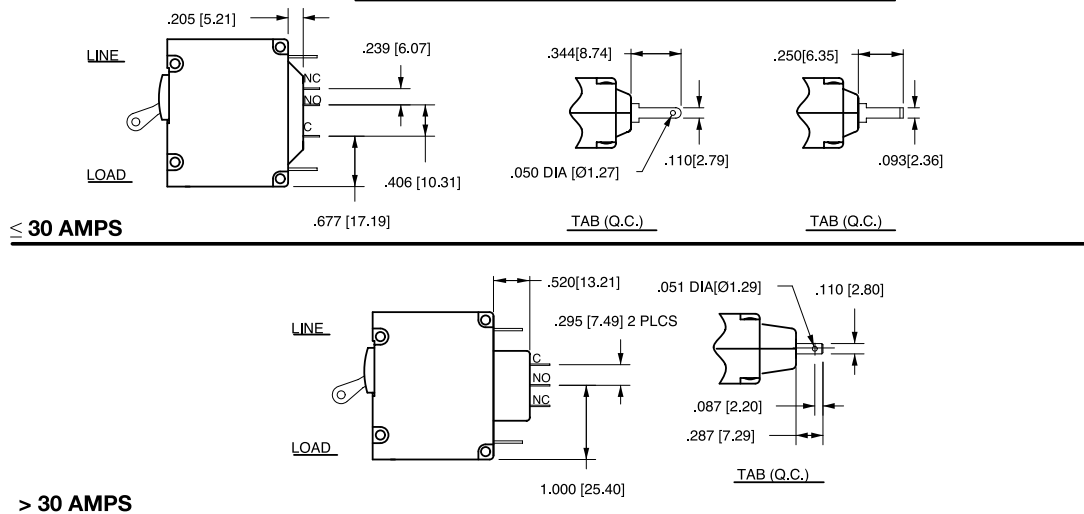

- Notes:
- All dimensions are in inches [millimeters].
  - Tolerance  $\pm .020$  [.51] unless otherwise specified.
  - Alarm Switch available with .110 x .020 Q.C. & Solder Lug Terminals Only.

# Circuit & Terminal Diagrams: in. [mm]

HANDLE POSITION VS. AUX/ALARM SWITCH MODE						
CIRCUIT BREAKER MODE	STANDARD C/B		MID TRIP C/B		MID TRIP C/B	
	HANDLE POSITION	AUX. SWITCH MODE	HANDLE POSITION	ALARM SWITCH MODE	HANDLE POSITION	AUX. SWITCH MODE (w/o ALARM SWITCH)
OFF						
ON						
ELECTRICAL TRIP						

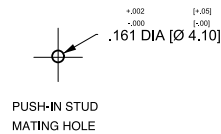
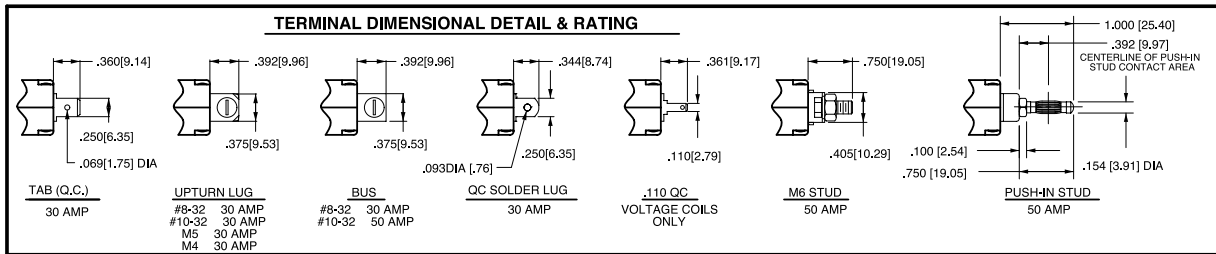

**TABLE A TIGHTENING TORQUE SPECIFICATIONS**

THREAD SIZE	TORQUE
#6-32 & M3 MOUNTING HARDWARE	7-9 IN-LBS [0.8-1.0 NM]
#8-32 & M4 THREAD TERMINAL SCREW	12-15 IN-LBS [1.4-1.7 NM]
#10-32 & M5 THREAD TERMINAL SCREW	15-20 IN-LBS [1.7-2.3 NM]

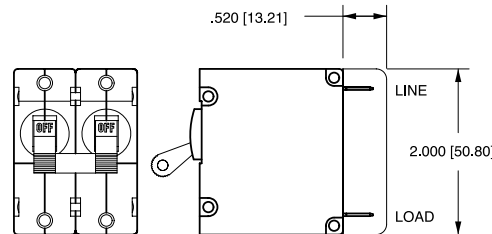

**TABLE B**

TERMINAL DESCRIPTION		DEPTH BEHIND PANEL
MAIN	TAB (Q.C.)	2.000 [50.80]
	SCREW TYPE	2.032 [51.60]
SHUNT, RELAY & DUAL COIL	TAB (Q.C.)	2.207 [56.10]
	SCREW #8-32 W/UPTURNED LUGS	2.364 [60.05]
AUX. SWITCH*	.093 TAB (Q.C.)	2.095 [53.20]
	.110 TAB (Q.C.)	2.189 [55.60]
	SOLDER TYPE	1.970 [50.00]

\* AVAILABLE ON SERIES TRIP AND SWITCH ONLY CIRCUITS. WHEN CALLED FOR ON MULTI-POLE UNITS, ONLY ONE AUX. SWITCH IS NORMALLY SUPPLIED, AS SHOWN IN MULTI-POLE IDENTIFICATION SCHEME.

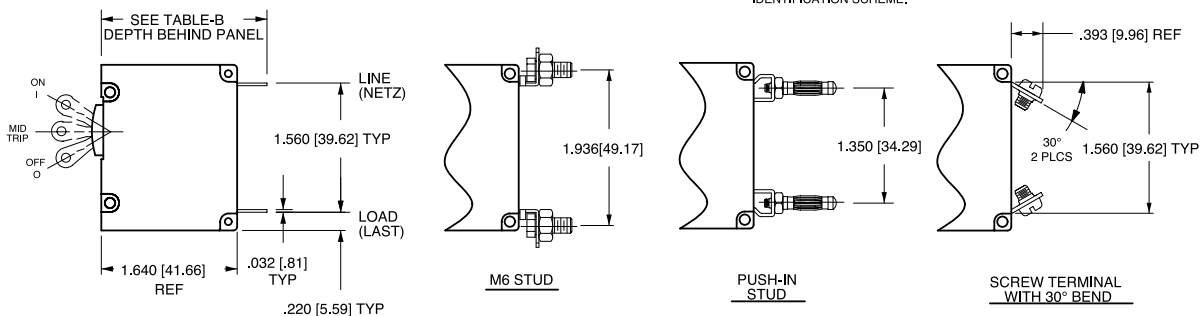

- Notes:
- All dimensions are in inches [millimeters].
  - Tolerance  $\pm 0.02$  [.51] unless otherwise specified.
  - Alarm Switch available with .110 x .020 QC & solder lug terminals only.

# Dimensional Specifications: in. [mm]

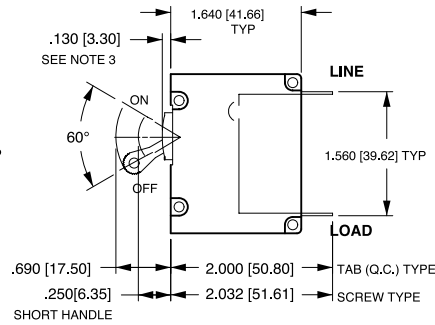
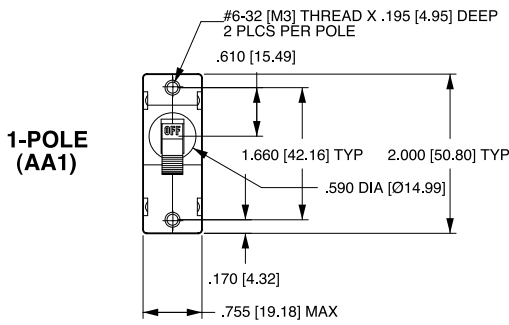

TAB (Q.C.) TYPE TERMINALS IN SERIES TRIP CIRCUIT CONFIGURATION SHOWN. FOR OTHER CONFIGURATIONS, SEE CIRCUIT AND TERMINAL DIAGRAMS.

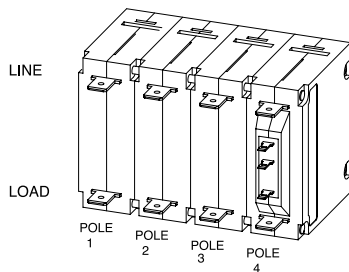
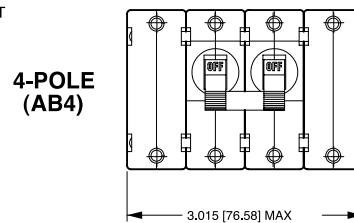
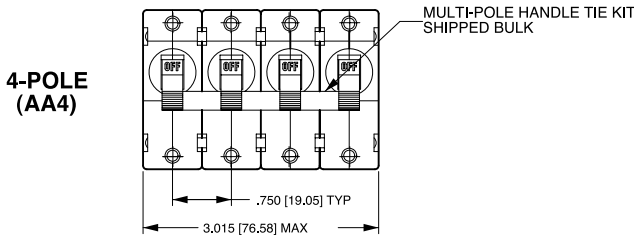
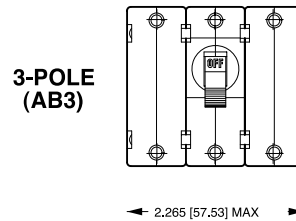
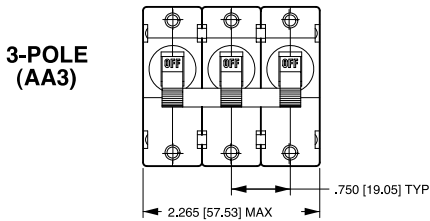
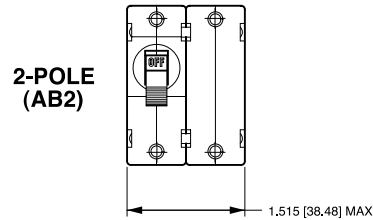
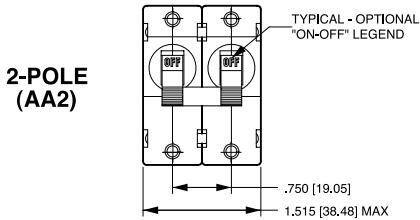

MULTI-POLE IDENTIFICATION SCHEME AS VIEWED FROM TERMINAL END OF BREAKER.

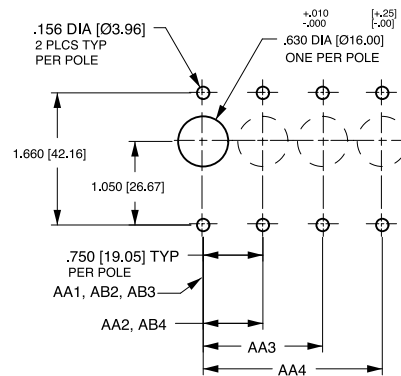

**PANEL CUTOUT DETAIL**  
TOLERANCES ±.005 [±.12] UNLESS OTHERWISE SPECIFIED

Notes:

- 1 All dimensions are in inches [millimeters].
- 2 Tolerance ± 0.20 [.51] unless otherwise specified.
- 3 For agency code P = .150 [3.81].

## Dimensional Specifications: in. [mm]

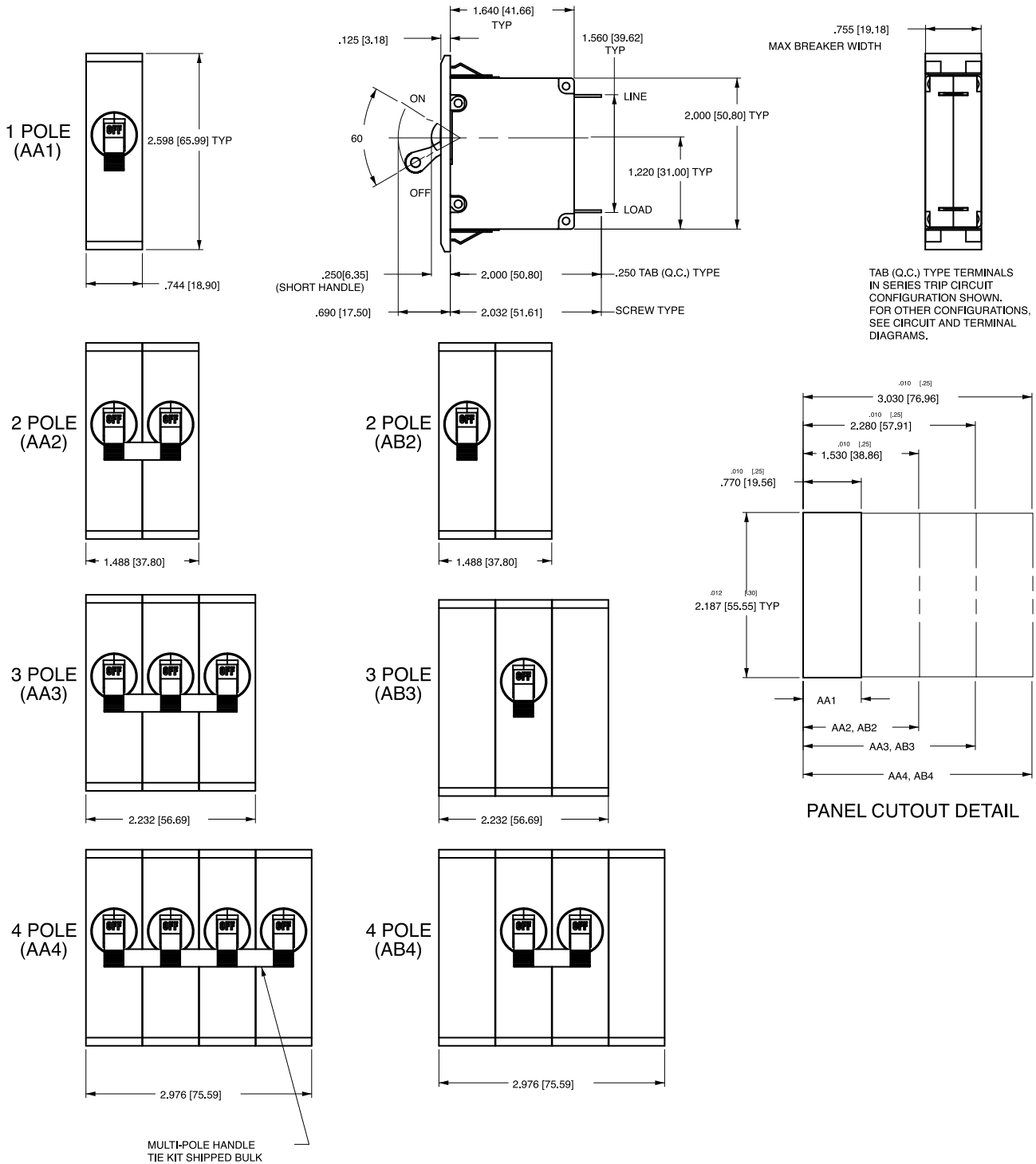

- Notes:  
 1 All dimensions are in inches [millimeters].  
 2 Recommended panel thickness: .040 [1.02] to .100 [2.54].  
 3 Tolerance  $\pm .020$  [.51] unless otherwise specified.



## Dimensional Specifications: in. [mm]

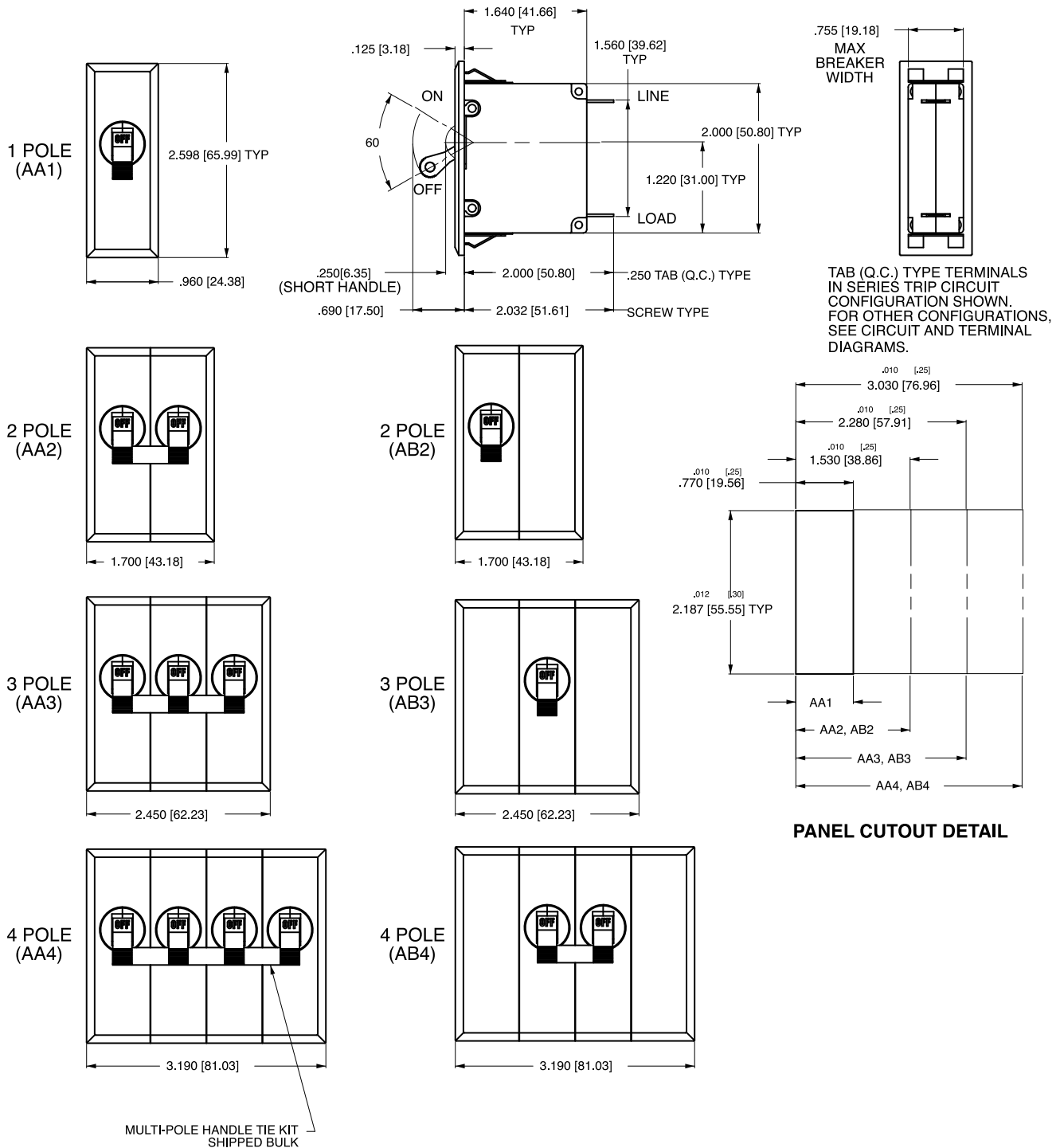

- Notes:
- 1 All dimensions are in inches [millimeters].
  - 2 Recommended panel thickness: .040 [1.02] to .100 [2.54].
  - 3 Tolerance  $\pm 0.020$  [.51] unless otherwise specified.

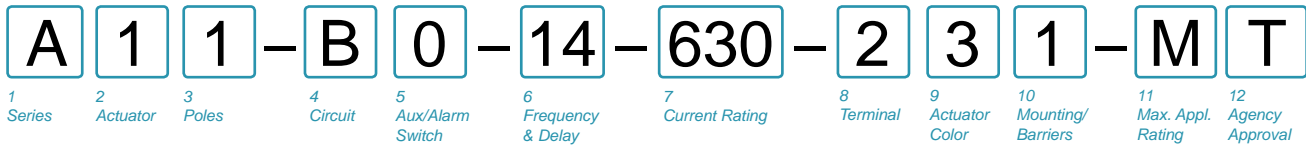

**1 SERIES**  
A

**2 ACTUATOR 1**  
**Two Color Visi-Rocker**  
 1 Indicate OFF, vertical legend  
 2 Indicate OFF, horizontal legend  
**Single color**  
 3 Vertical legend  
 4 Horizontal legend  
**Push-To-Reset, Visi-Rocker**  
 5 Indicate OFF, vertical legend  
 6 Indicate OFF, horizontal legend  
**Push-To-Reset, Single color**  
 7 Vertical legend  
 8 Horizontal legend

	INDICATE "OFF"	SINGLE COLOR
VERTICAL STYLE	CODE "1", "5" 	CODE "3", "7" 
HORIZONTAL STYLE	CODE "2", "6" 	CODE "4", "8" 

**3 POLES 2**  
 1 One    2 Two    3 Three

**4 CIRCUIT**  
 B Series Trip (Current)

**5 AUXILIARY / ALARM SWITCH 3**  
 0 without Aux Switch    7 S.P.S.T., 0.110 Q.C. Term. (Gold Contacts)  
 1 S.P.D.T., 0.093 Q.C. Term.    8 S.P.S.T., 0.187 Q.C. Term.  
 2 S.P.D.T., 0.110 Q.C. Term.    9 S.P.D.T., 0.187 Q.C. Term.

**6 FREQUENCY & DELAY**  
 11 DC Ultra Short    52 DC, Short, Hi-Inrush  
 12 DC Short    54 DC, Medium, Hi-Inrush  
 14 DC Medium    56 DC, Long, Hi-Inrush  
 16 DC Long

**7 CURRENT RATING (AMPERES)**

CODE	AMPERES	CODE	AMPERES	CODE	AMPERES	CODE	AMPERES
020	0.020	225	0.250	420	2.000	611	11.000
025	0.025	230	0.300	522	2.250	711	11.500
030	0.030	235	0.350	527	2.750	612	12.000
035	0.035	240	0.400	430	3.000	712	12.500
040	0.040	245	0.450	435	3.500	613	13.000
045	0.045	250	0.500	440	4.000	614	14.000
050	0.050	255	0.550	445	4.500	615	15.000
055	0.055	260	0.600	450	5.000	616	16.000
060	0.060	265	0.650	455	5.500	617	17.000
065	0.065	270	0.700	460	6.000	618	18.000
070	0.070	275	0.750	465	6.500	620	20.000
075	0.075	280	0.800	470	7.000	622	22.000
080	0.080	285	0.850	475	7.500	624	24.000
085	0.085	290	0.900	480	8.000	625	25.000
090	0.090	295	0.950	485	8.500	630	30.000
095	0.095	410	1.000	490	9.000	635	35.000
210	0.100	512	1.250	495	9.500	640	40.000
215	0.150	415	1.500	610	10.000	645	45.000
220	0.200	517	1.750	710	10.500	650	50.000

**8 TERMINAL 5**  
 1<sup>6</sup> Push-On 0.250 Tab (Q.C.)    9 Screw 10-32 (Bus Type) & 30° bend  
 2 Screw 8-32 with upturned lugs    B Screw M5 with upturned lugs  
 3<sup>7</sup> Screw 8-32 (Bus Type)    F Screw M5 with upturned lugs & 30° bend  
 4 Screw 10-32 with upturned lugs    G Screw M5 (Bus Type) & 30° bend  
 5<sup>7</sup> Screw 10-32 (Bus Type)    H Screw M5 (Bus Type)  
 6 Screw 8-32 with upturned lugs & 30° bend    M<sup>7</sup> M6 Threaded Stud  
 7 Screw 8-32 (Bus Type) & 30° bend    P<sup>8</sup> Printed Circuit Board Terminals  
 8 Screw 10-32 with upturned lugs & 30° bend    Q<sup>9</sup> Push-In Stud

**9 ACTUATOR COLOR & LEGEND**

Actuator or Visi-Color 11	Marking:		Marking Color	
	ON-OFF	Dual 11	Single Color	Visi-Rocker
White	B	1	Black	White
Black	D	2	White	n/a
Red	G	3	White	Red
Green	J	4	White	Green
Blue	L	5	White	Blue
Yellow	N	6	Black	Yellow
Gray	Q	7	Black	Gray
Orange	S	8	Black	Orange

**10 MOUNTING / BARRIERS 12**

	STANDARD ROCKER BEZEL	BARRIERS
	Threaded Insert, 2 per pole	
	FLAT ROCKER ACTUATOR	
1	6-32 x 0.195 inches	no
A	6-32 X 0.195 inches (multi-pole units only)	yes
2	ISO M3 x 5mm	no
B	ISO M3 x 5mm (multi-pole units only)	yes
	RECESSED OFF SIDE ROCKER ACTUATOR	
5	6-32 x 0.195 inches	no
E	6-32 x 0.195 inches (multi-pole units only)	yes
6	ISO M3 x 5mm	no
F	ISO M3 x 5mm (multi-pole units only)	yes
	PUSH-TO-RESET BEZEL, Threaded Insert, 2 per pole	
3	6-32 x 0.195 inches	no
C	6-32 x 0.195 inches (multi-pole units only)	yes
4	ISO M3 x 5mm	no
D	ISO M3 x 5mm (multi-pole units only)	yes

**11 MAXIMUM APPLICATION RATING**  
 M 80 DC

**12 AGENCY APPROVAL**  
 T UL489A Listed  
 J UL489A Listed, TUV Certified

- Notes:
- 1 Push-To-Reset actuators have OFF portion of rocker shrouded.
  - 2 Multi-pole breakers have all breakers identical except when specifying Auxiliary switch and/or mixed poles, and have one rocker per breaker.
  - 3 Auxiliary Switch breakers with Series Trip circuits: ≤ 30A, are supplied with standard half shells. 30-50A are supplied with extended boat (B-Style) half shells.
  - 4 VDE Certification available with single pole breakers only. UL489A Listing available with one and two pole breakers.
  - 5 Screw Terminals are recommended on ratings greater than 20 amps. Ratings over 30 amps are only available with Terminal Codes 5, 9, G, H, M and Q.
  - 6 Terminal Code 1 (Push-On) available up to 25 amps with TUV or VDE Certification and 30 amps with UL489A Listing, but is not recommended over 20 amps.
  - 7 Terminal Codes 3, 5 and H (Bus Type) with TUV or VDE, are supplied with Lock Washers, and Terminal Code M (M6 Threaded Stud) with VDE is supplied with Lock and Flat Washers. These breakers are only TUV or VDE Certified when the washers are used.
  - 8 Single pole breakers with Terminal Code P (Printed Circuit Board) are available up to 30 amps with VDE Certification and 50 amps with UL489A Listing.
  - 9 Terminal Code Q not available with VDE certification.
  - 10 Color shown is Visi and Legend with remainder of rocker black. Dual = ON-OFF/I-O legend.
  - 11 Legend on Push-to-reset bezel/shroud is white with single color actuator codes R & U.
  - 12 Legend on Push-To-Reset bezel/shroud matches Visi-Color of rocker with actuator codes N & O. Rockerguard available with actuator codes C through K

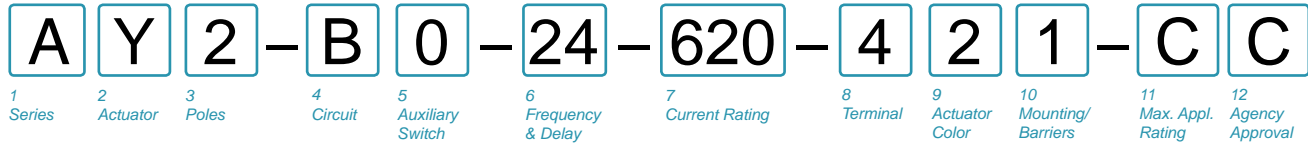

**1 SERIES**

A

**2 ACTUATOR <sup>1</sup>**

Y Single Color Recessed Paddle Actuator with Vertical Legends

**3 POLES <sup>2</sup>**

1 One                      2 Two                      3 Three

**4 CIRCUIT**

A Switch-Only (No Coil)      F Relay Trip (Current)  
 B Series Trip (Current)      G Relay Trip (Voltage)  
 C Series Trip (Voltage)      H Dual Coil with Shunt Trip Voltage Coil  
 D Shunt Trip (Current)      K Dual Coil with Shunt Trip Current Coil  
 E Shunt Trip (Voltage)

**5 AUXILIARY SWITCH**

0 without Aux Switch  
 1 S.P.D.T. with 0.093 Q.C. Terminals  
 2 S.P.D.T. with 0.110 Q.C. Terminals  
 3 S.P.D.T. with 0.139 Solder Lug Terminals  
 4 S.P.D.T. with 0.110 Q.C. Terminals (Gold Contacts)  
 5 S.P.D.T. with 0.093 Q.C. Terminals (Gold Contacts)  
 6 S.P.S.T.-N.O. with 0.139 Solder Lug Terminals  
 7 S.P.S.T.-N.O. with 0.110 Q.C. Terminals (Gold Contacts)  
 8 S.P.S.T.-N.O. with 0.187 Q.C. Terminals  
 9 S.P.D.T. with 0.187 Q.C. Terminals

**6 FREQUENCY & DELAY <sup>3</sup>**

3 DC, 50/60 Hz Switch Only	22 50/60 Hz Short
10 DC Instantaneous	24 50/60 Hz Medium
11 DC Ultra Short	26 50/60 Hz Long
12 DC Short	42 50/60 Hz Short Hi-Inrush
14 DC Medium	44 50/60 Hz Medium Hi-Inrush
16 DC Long	46 50/60 Hz Long Hi-Inrush
20 50/60 Hz Instantaneous	52 DC, Short, Hi-Inrush
21 50/60 Hz Ultra Short	54 DC, Medium, Hi-Inrush
	56 DC, Long, Hi-Inrush

**7 CURRENT RATING (AMPERES) <sup>4</sup>**

CODE	AMPERES				
220	0.200	295	0.950	460	6.000
225	0.250	410	1.000	465	6.500
230	0.300	512	1.250	470	7.000
235	0.350	415	1.500	475	7.500
240	0.400	517	1.750	480	8.000
245	0.450	420	2.000	485	8.500
250	0.500	522	2.250	490	9.000
255	0.550	425	2.500	495	9.500
260	0.600	527	2.750	610	10.000
265	0.650	430	3.000	710	10.500
270	0.700	435	3.500	611	11.000
275	0.750	440	4.000	711	11.500
280	0.800	445	4.500	612	12.000
285	0.850	450	5.000	712	12.500
290	0.900	455	5.500	613	13.000

**OR VOLTAGE COIL (NORMAL RATED VOLTAGE)**

CODE	AMPERES				
A06	6 DC	A32	32 DC	J12	12 AC
A12	12 DC	A48	48 DC	J18	18 AC
A18	18 DC	A65	65 DC	J24	24 AC
A24	24 DC	J06	6 AC	J48	48 AC
				J65	65 AC
				K20	120 AC
				L40	240 AC

**8 TERMINAL**

1 Push-On 0.250 Tab (Q.C.)	C Screw, M4 with upturned lugs
2 Screw 8-32 with upturned lugs	E Screw, M4 (Bus Type)
3 Screw 8-32 (Bus Type)	F Screw M5 with upturned lugs & 30° bend
4 Screw 10-32 with upturned lugs	G Screw M5 (Bus Type) & 30° bend
5 Screw 10-32 (Bus Type)	H Screw M5 (Bus Type)
6 Screw 8-32 with upturned lugs & 30° bend	L 0.250 Q.C./Solder Lug
7 Screw 8-32 (Bus Type) & 30° bend	M M6 Threaded Stud
8 Screw 10-32 with upturned lugs & 30° bend	P Printed Circuit Board Terminals
9 Screw 10-32 (Bus Type) & 30° bend	Q Push-In Stud
B Screw M5 with upturned lugs	R Screw, M4 with upturned lugs & 30° Bend
	S Screw, M5 with upturned lugs
	T Screw, M4 with upturned lugs

**9 ACTUATOR COLOR & LEGEND <sup>5</sup>**

Actuator Color	I-O	ON-OFF	Dual	Legend Color
White	A	B	1	Black
Black	C	D	2	White
Red	F	G	3	White
Green	H	J	4	White
Blue	K	L	5	White
Yellow	M	N	6	Black
Gray	P	Q	7	Black
Orange	R	S	8	Black

**10 MOUNTING / BARRIERS**

	BARRIERS
1 6-32 x 0.195 inches	no
A 6-32 X 0.195 inches (multi-pole units only)	yes
2 ISO M3 x 5mm	no
B ISO M3 x 5mm (multi-pole units only)	yes

**11 MAXIMUM APPLICATION RATING <sup>6</sup>**

A 65 VDC  
 C 120/240 VAC (Available only on 2 or 3-Pole units)  
 K 120 VAC  
 M 80 DC

**12 AGENCY APPROVAL <sup>7</sup>**

A Without Approvals  
 C UL Recognized and CSA Accepted  
 T UL 489A

Notes:

- 1 All standard catalog numbers are supplied with Vertical Legends. For Horizontal or other non-standard legends, choose "X" and order as a special catalog number.
- 2 For rating (T) 2 & 3 Pole not available.
- 3 Frequency and Time Delay ratings of (03, 20, 21, 22, 24, 26, 42, 44, 46) not available with approval T.
- 4 Voltage Coil Ratings starting with (J, K, or L) not available with approval T.
- 5 "OFF" and/or "O" Legends are on Bracket and are only visible when the Paddle Actuator is in the off position.
- 6 Maximum Application Ratings (C & K) not available with approval T.
- 7 Not all approvals are available in all constructions. Consult factory for details.

## Circuit & Terminal Diagrams: in. [mm]

CIRCUIT BREAKER PROFILE	CIRCUIT SCHEMATIC		CIRCUIT CODE	AUX. SWITCH CODE	CIRCUIT SCHEMATIC		CIRCUIT CODE	AUX. SWITCH CODE
	ANSI	IEC			ANSI	IEC		
<b>2 TERMINALS</b> 	<b>SWITCH ONLY (NO COIL)</b> 		A	0	<b>SERIES TRIP</b> 		B C	0
<b>5 TERMINALS</b> 	<b>SWITCH ONLY (NO COIL) WITH AUXILIARY SWITCH (4)</b> 		A	1 4 2 2	<b>SERIES TRIP WITH AUXILIARY SWITCH (4)</b> 		B C	1 4 2 2
<b>3 TERMINALS</b> 	<b>SHUNT TRIP</b> 		D E	0	<b>DUAL COIL; SERIES TRIP CURRENT COIL, SHUNT TRIP VOLTAGE COIL</b> 		H	0
<b>4 TERMINALS</b> 	<b>RELAY TRIP</b> 		F G	0	<b>DUAL COIL; SERIES TRIP CURRENT COIL, RELAY TRIP VOLTAGE COIL</b> 		K	0

TERMINAL DESCRIPTION		DEPTH BEHIND PANEL
MAIN	TAB (Q.C.)	2.370 [60.20]
	SCREW TYPE	2.402 [61.01]
SHUNT, RELAY & DUAL COIL	TAB (Q.C.)	2.577 [65.46]
	SCREW #8-32 W/UPTURNED LUGS	2.734 [69.44]
AUX. SWITCH*	.093 TAB (Q.C.)	2.465 [62.61]
	.110 TAB (Q.C.)	2.559 [65.00]
	SOLDER TYPE	2.340 [59.44]

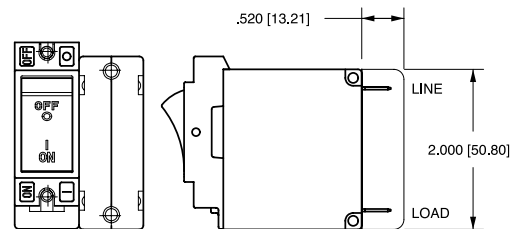

\* AVAILABLE ON SERIES TRIP AND SWITCH ONLY CIRCUITS. WHEN CALLED FOR ON MULTI-POLE UNITS, ONLY ONE AUX. SWITCH IS NORMALLY SUPPLIED, AS VIEWED IN MULTI-POLE IDENTIFICATION SCHEME.

**BARRIER FOR UL-RECOGNIZED MULTI-POLE BREAKERS**

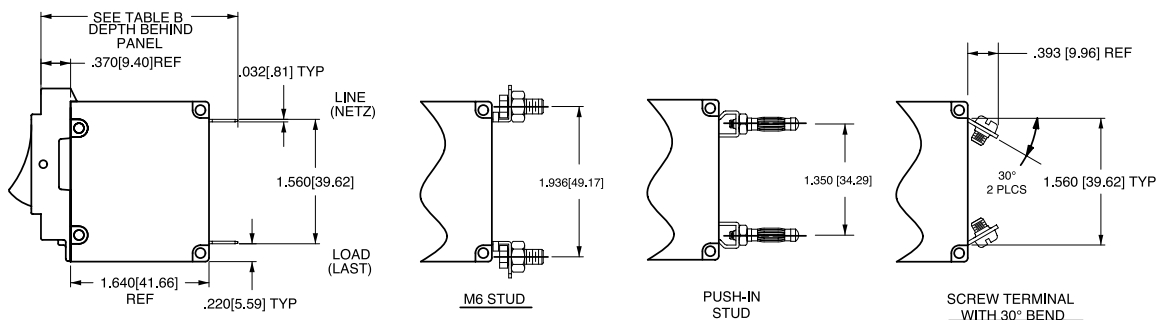

- Notes:
- All dimensions are in inches [millimeters].
  - Tolerance  $\pm .020$  [.51] unless otherwise specified.
  - Schematic shown represents current trip circuit.
  - Circuits shown for >30 amps / VDE.

## Dimensional Specifications: in. [mm]

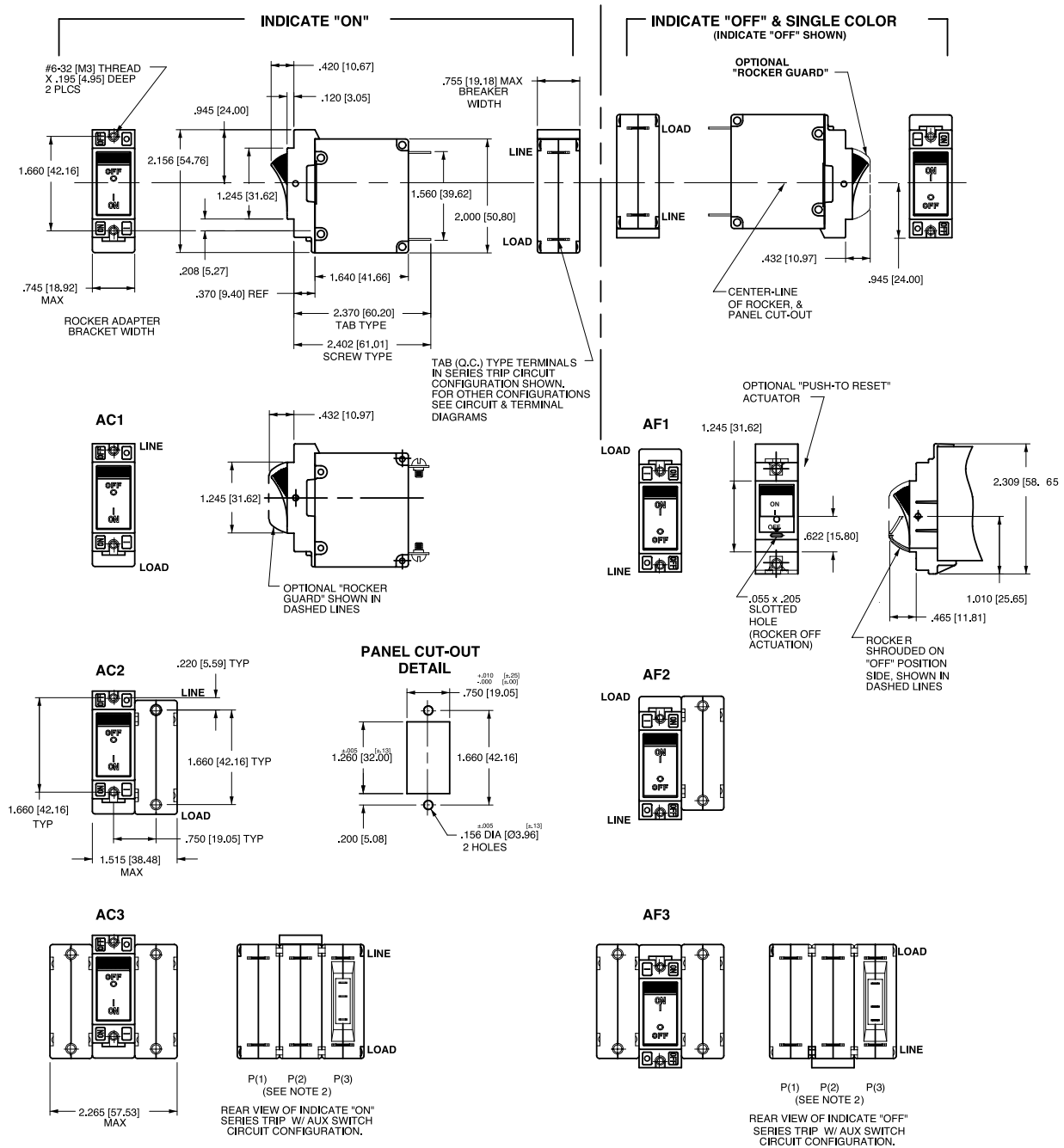

**Notes:**

- 1 Dimensions apply to all variations shown. Notice that circuit breaker line & load terminal orientation on indicate OFF is opposite of indicate ON.
- 2 For pole orientation with horizontal legend, rotate front view clockwise 90°.
- 3 All dimensions are in inches [millimeters].
- 4 Tolerance  $\pm 0.20$  [.51] unless otherwise specified.

## Dimensional Specifications: in. [mm]

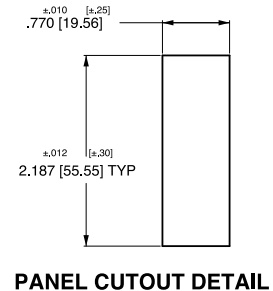
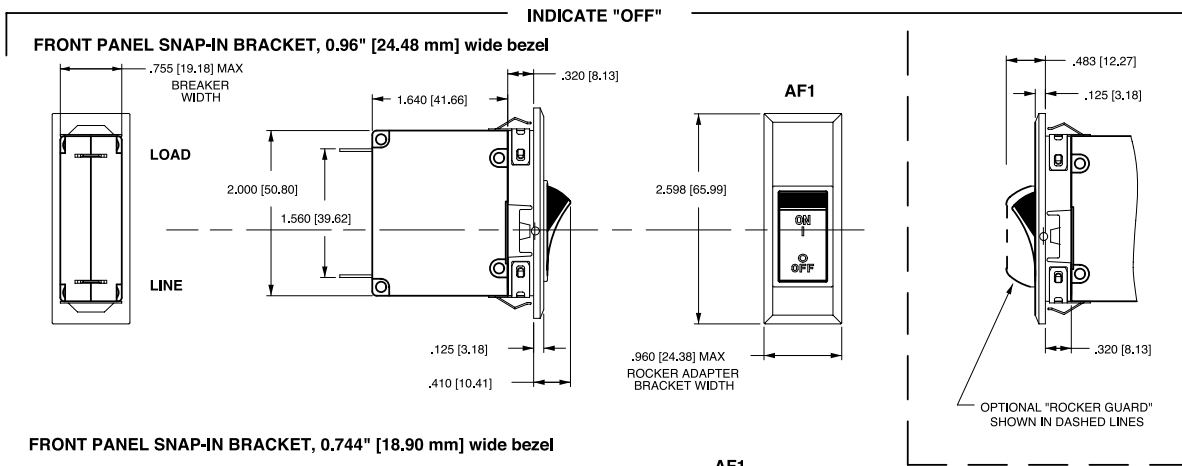
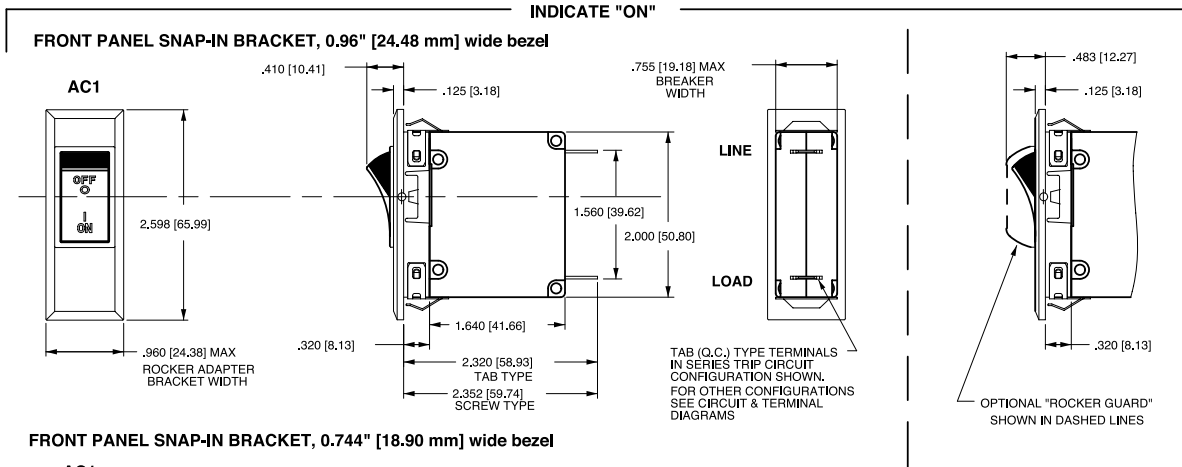

- Notes:
- 1 Dimensions apply to all variations shown. Notice that circuit breaker line & load terminal
  - 2 For pole orientation with horizontal legend, rotate front view clockwise 90°. Orientation on indicate "OFF" is opposite of indicate "ON"
  - 3 Recommended panel thickness: .04 0 [1.02] to .100 [2.54]
  - 4 All dimensions are in Inches [millimeters].
  - 5 Tolerance  $\pm 0.020$  [.51] unless otherwise specified.

# Dimensional Specifications: in. [mm]

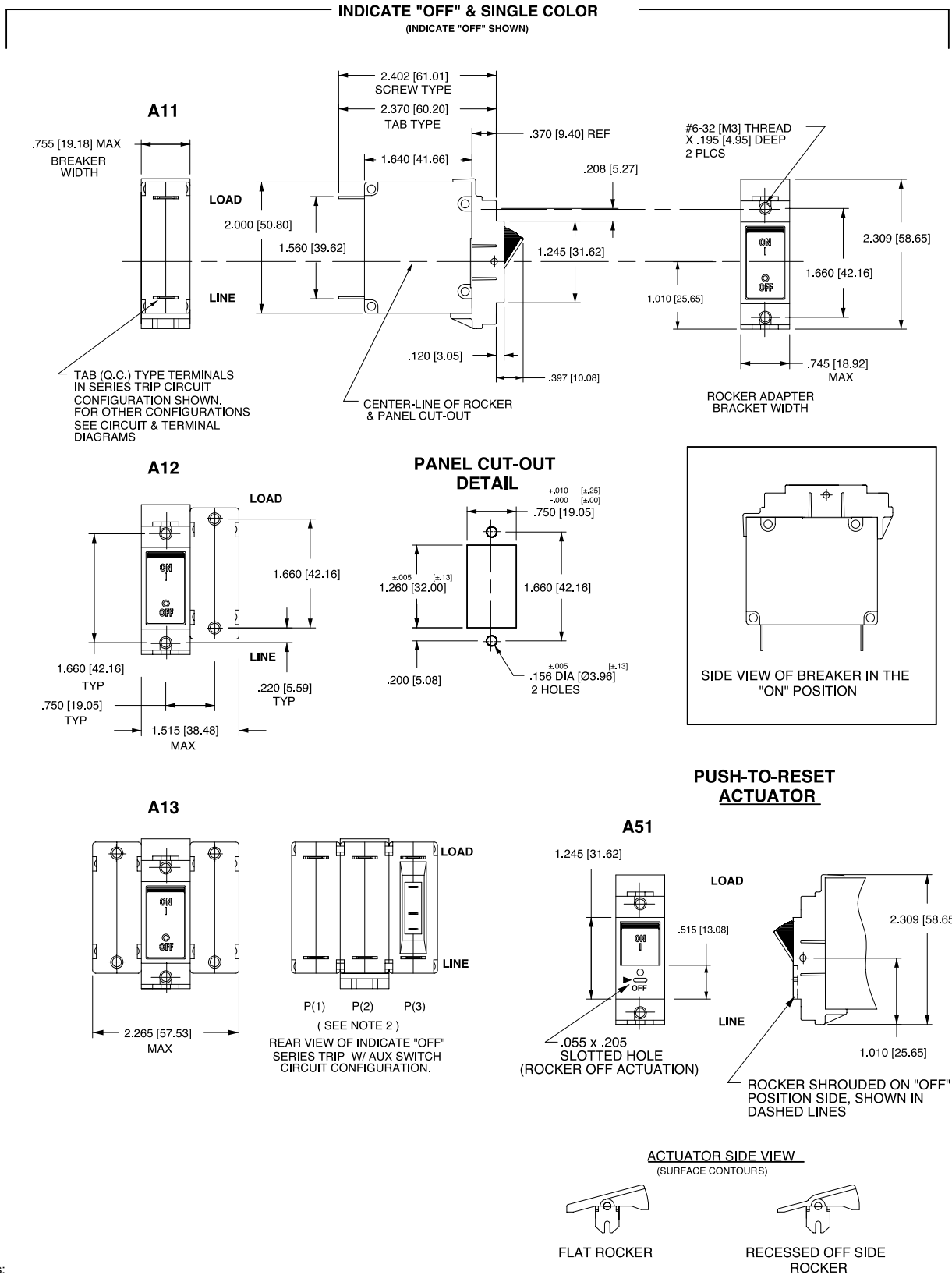

- Notes:  
 1 All dimensions are in inches [millimeters].  
 2 For pole orientation with horizontal legend, rotate front view clockwise 90°.  
 3 Tolerance ± 0.20 [.51] unless otherwise specified.

## Dimensional Specifications: in. [mm]

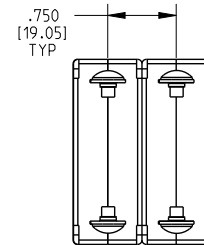
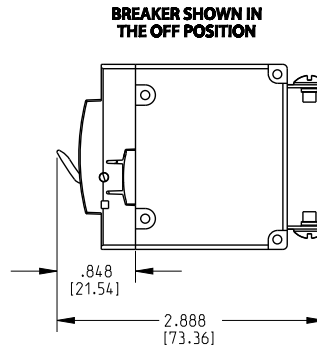
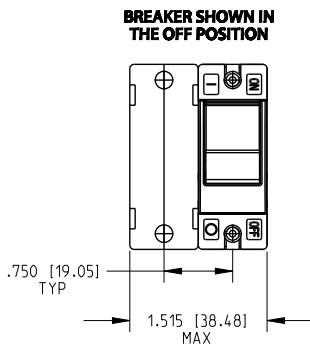
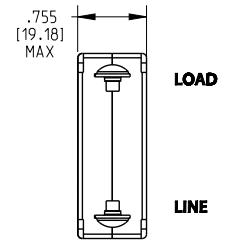
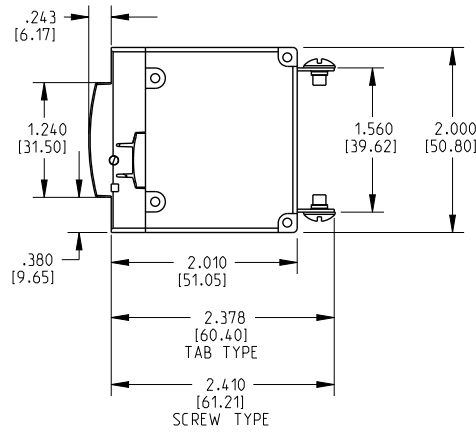
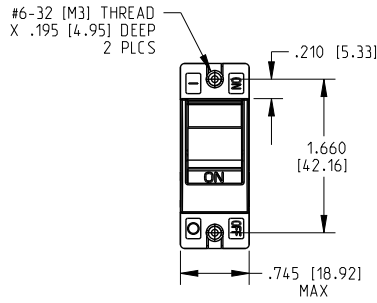

### PANEL CUT-OUT DETAIL

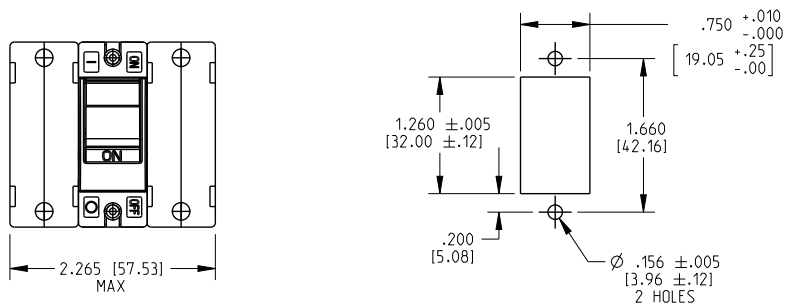

- Notes:
- 1 All dimensions are in inches [millimeters].
  - 2 Tolerance ± 0.20 [51] unless otherwise specified



## PC Terminal Diagrams: in. [mm]

### A-SERIES ROCKER

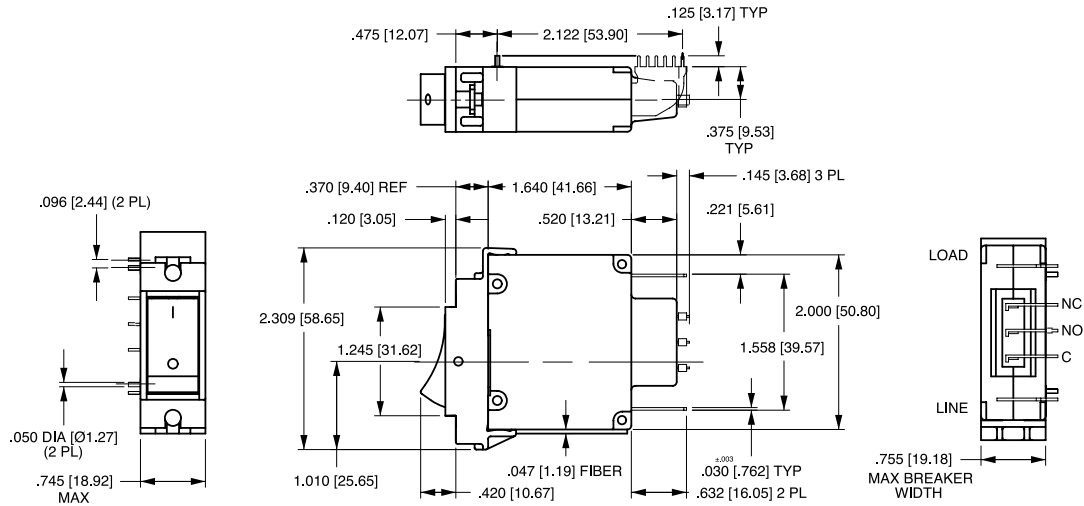

### A-SERIES HANDLE

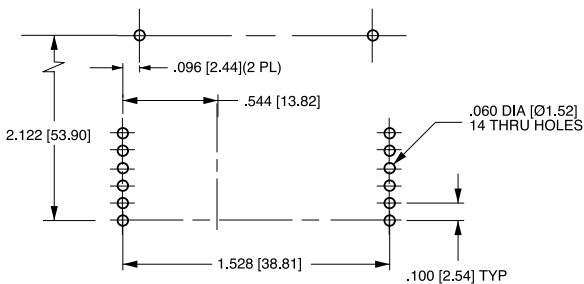
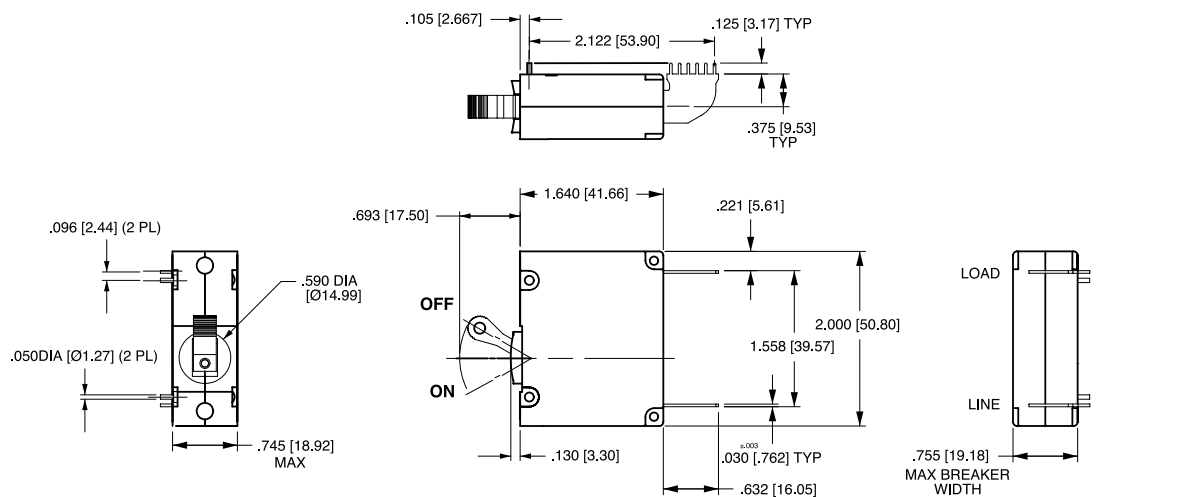

P.C. FOOT PRINT

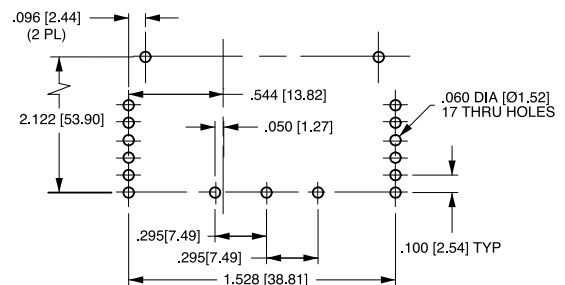

P.C. FOOT PRINT WITH AUX. SWITCH

Notes:

- 1 Drawing illustrates A-Series with VDE certification.
- 2 All dimensions are in inches [millimeters].
- 3 Tolerance  $\pm 0.20$  [.51] unless otherwise specified

# B-Series

## CIRCUIT BREAKER

Carling Technologies' B-Series hydraulic magnetic circuit breakers are specifically designed for applications requiring extra insulation and tongue and groove half-shell constructions. The B-Series carries global regulatory safety approvals for spacing requirements and are ideal for use as general purpose as well as full load amp applications. Available with various choices of time delays, terminals, actuator styles, with a wide range of standard colors and imprinting.

1-6 poles; ratings from 0.02 to 50 amps, up to 277VAC or 80VDC; UL recognized, CSA, VDE -0642, TUV, UL-1500, UL489A Listed



### Product Highlights:

- Meet CSA Standard 22.2 No. 100 for the Generator & Welder markets
- Extra insulation and tongue & groove half-shell constructions
- UL Recognized - UL Standard 508, 1077, 1500
- UL Listed - UL Standard 489, 489A
- CSA Accepted
- TUV Certified
- VDE Certified

Only Telecom-Datcom applicable ordering schemes and drawings are shown in this catalog.  
For complete product details, please visit [www.carlingtech.com](http://www.carlingtech.com)

**Electrical**

Maximum Voltage 277VAC 50/60 Hz, 80VDC  
 Current Ratings Standard current coils: 0.100, 0.250, 0.500, 0.750, 1.00, 2.50, 5.00, 7.50, 10.0, 15.0, 20.0, 25.0, 30.0, 35.0, 40.0 and 50.0 amps. Other ratings available, see ordering scheme.  
 Standard Voltage Coils DC - 6V, 12V; AC - 120V, other ratings available, see ordering scheme.  
 Auxiliary Switch Rating SPDT; 10.1 AMPS - 250VAC, 1.0A 65 VDC or 0.5A 80 VDC, 0.1 Amps - 125VAC (with gold contacts). VDE-1.0 Amp - 125VAC.  
 Insulation Resistance Minimum of 100 Megohms at 500 VDC.  
 Dielectric Strength UL, CSA-1500 V 50/60 Hz for one minute between all electrically isolated terminals. B-Series circuit breakers comply with the 8mm spacing and 3750V 50/60 Hz dielectric requirements from hazardous voltage to operator accessible surfaces, between adjacent poles and from main circuits to auxiliary circuits per Publications EN 60950 and VDE 0805.  
 Resistance, Impedance Values from Line to Load Terminal - based on Series Trip Circuit Breaker.

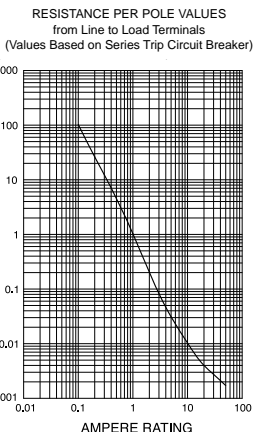

CURRENT (AMPS)	TOLERANCE (%)
0.10 - 5.0	15
5.1 - 20.0	25
20.1 - 50.0	35

**Pulse Tolerance Curves**

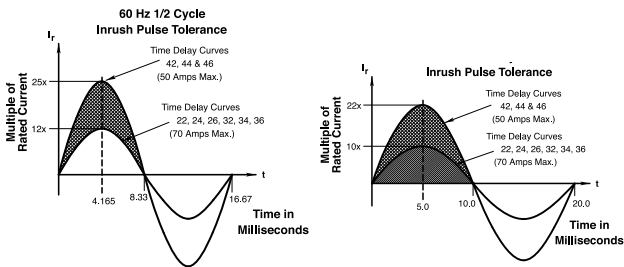

\*Manufacturer reserves the right to change product specification without prior notice.

**Mechanical**

Endurance 10,000 ON-OFF operations @ 6 per minute; with rated Current and Voltage.  
 Trip Free All B-Series Circuit Breakers will trip on overload, even when Handle is forcibly held in the ON position.  
 Trip Indication The operating Handle moves positively to the OFF position when an overload causes the breaker to trip.  
 Number of Poles 1 - 6 poles at 30 Amps or less. 1 and 2 poles at 31 Amps thru 50 Amps.  
 Internal Circuit Config. Series, (with or without auxiliary switch), Shunt and Relay with current or voltage trip coils, Dual Coil, Switch Only (with or without auxiliary switch).  
 Weight Approximately 65 grams/pole. (Approximately 2.32 ounces/pole.)  
 Standard Colors Housing- Black; Actuator - See Ordering Scheme.

**Physical**

**Environmental**

Designed and tested in accordance with requirements of specification MIL-PRF-55629 & MIL-STD-202 as follows:  
 Shock Withstands 100 Gs, 6ms, sawtooth while carrying rated current per Method 213, Test Condition "I". Instantaneous and ultra-short curves tested @ 90% of rated current.  
 Vibration Withstands 0.060" excursion from 10-55 Hz, and 10 Gs 55-500 Hz, at rated current per Method 204C, Test Condition A. Instantaneous and ultrashort curves tested at 90% of rated current.  
 Moisture Resistance Method 106D, i.e., ten 24-hour cycles @ + 25°C to +65°C, 80-98% RH.  
 Salt Spray Method 101, Condition A (90-95% RH @ 5% NaCl Solution, 96 hrs).  
 Thermal Shock Method 107D, Condition A (Five cycles @ -55°C to +25°C to +85°C to +25°C).  
 Operating Temperature -40° C to +85° C

Electrical Tables

Table A: Lists UL Recognized & CSA Certified configurations and performance capabilities as a Component Supplementary Protector.

B-SERIES TABLE A: COMPONENT SUPPLEMENTARY PROTECTORS										
CIRCUIT CONFIGURATION	VOLTAGE			CURRENT RATING		SHORT CIRCUIT CAPACITY (AMPS)		APPLICATION CODES		CONSTRUCTION NOTES
	MAX. RATING	FREQUENCY	PHASE	FULL LOAD AMPS	GENERAL PURPOSE AMPS	UL/CSA		UL	CSA	
						WITH BACKUP FUSE	WITHOUT BACKUP FUSE			
SERIES	65	DC	--	31 - 50	--	--	7500	TC1,2, OL1,U1	TC1,2, OL1,U1	
	80	DC	--	0.02 - 30	--	--	7500	TC1,2, OL1,U1	TC1,2, OL1,U1	
				---	31 - 50	--	7500	TC1,2, OL0,U1	TC1,2, OL0,U1	
	125	50 / 60	1	1 - 50	--	--	2000	TC1, OL1,U2	TC1, OL1,U2	
	125	50 / 60	1 <sup>4</sup>	1 - 50	--	--	1000	TC1, OL1,U2	TC3, OL1,U3	
	125 / 250	50 / 60	1 <sup>3</sup>	0.02 - 30	--	--	3000	TC1,2, OL1,U1	TC1,2, OL1,U1	
	250	50 / 60	1	0.02 - 30	--	--	1500	TC1, OL0,U2	TC1, OL0,U2	Single Pole Break
				0.02 - 30	--	--	3000	TC1, OL1,U2	TC1, OL1,U2	Two Pole Break
				---	31 - 50	--	3000	TC1,2, OL0,U1	TC1,2, OL0,U1	
			1 <sup>4</sup>	1 - 50	--	1000	TC1, OL1,U2	TC3, OL1,U3		
3			0.02 - 30	--	5000 <sup>2</sup>	--	TC1,2, OL1,C1	TC1,2, OL1,C1		
			31 - 50	--	2000 <sup>1</sup>	--	TC1,2, OL1,C1	TC1,2, OL1,C1		
277	50 / 60	1	0.02 - 30	--	5000 <sup>1</sup>	--	TC1,2, OL1,C1	TC1,2, OL1,C1		
DUAL COIL	65	DC	--	0.02 - 50	--	--	7500	TC1,2, OL1,U1	TC1,2, OL1,U1	
	80	DC	--	0.02 - 30	--	--	7500	TC1,2, OL1,U1	TC1,2, OL1,U1	
				---	31 - 50	--	7500	TC1,2, OL0,U1	TC1,2, OL0,U1	
	125	50 / 60	1	1 - 50	--	--	2000	TC1, OL1,U2	TC1, OL1,U2	
	125 / 250	50 / 60	1 <sup>3</sup>	0.02 - 30	--	--	3000	TC1,2, OL1,U1	TC1,2, OL1,U1	
	250	50 / 60	1	0.02 - 30	--	--	1500	TC1, OL0,U2	TC1, OL0,U2	Single Pole Break
				0.02 - 30	--	--	3000	TC1, OL1,U2	TC1, OL1,U2	Two Pole Break
				---	31 - 50	--	3000	TC1,2, OL0,U1	TC1,2, OL0,U1	
			1 <sup>4</sup>	1 - 50	--	1000	TC1, OL1,U2	TC3, OL1,U3		
			3	0.02 - 30	--	5000 <sup>2</sup>	--	TC1,2, OL1,C1	TC1,2, OL1,C1	
			31 - 50	--	2000 <sup>1</sup>	--	TC1,2, OL1,C1	TC1,2, OL1,C1		
277	50 / 60	1	0.02 - 30	--	5000 <sup>1</sup>	--	TC1,2, OL1,U1	TC1,2, OL1,U1		
SHUNT	80	DC	--	0.02 - 30	--	--	7500	TC1,2, OL1,U1	TC1,2, OL1,U1	
	125 / 250	50 / 60	1 <sup>3</sup>	0.02 - 30	--	--	3000	TC1,2, OL1,U1	TC1,2, OL1,U1	
				0.02 - 30	--	--	3000	TC1,2, OL1,U1	TC1,2, OL1,U1	
	250	50 / 60	3	0.02 - 30	--	5000 <sup>2</sup>	--	TC1,2, OL1,C1	TC1,2, OL1,C1	
				0.02 - 30	--	5000 <sup>1</sup>	--	TC1,2, OL1,C1	TC1,2, OL1,C1	
277	50 / 60	1	0.02 - 30	--	5000 <sup>1</sup>	--	TC1,2, OL1,C1	TC1,2, OL1,C1		
RELAY	80	DC	--	0.02 - 30	--	--	7500	TC1,2, OL1,U1	TC1,2, OL1,U1	
	125 / 250	50 / 60	1 <sup>3</sup>	0.02 - 30	--	--	3000	TC1,2, OL1,U1	TC1,2, OL1,U1	
				0.02 - 30	--	--	3000	TC1,2, OL1,U1	TC1,2, OL1,U1	
	250	50 / 60	3	0.02 - 30	--	5000 <sup>2</sup>	--	TC1,2, OL1,C1	TC1,2, OL1,C1	
0.02 - 30				--	5000 <sup>1</sup>	--	TC1,2, OL1,C1	TC1,2, OL1,C1		
SWITCH ONLY	65	DC	--	0.02 - 50	--	--	--	--	--	
	80	DC	--	0.02 - 30	--	--	--	--	--	
				0.02 - 30	--	--	--	--	--	
	250	50 / 60	1	---	31 - 50	--	--	--	--	
0.02 - 50				--	--	--	--	--		
277	50 / 60	1	0.02 - 30	31 - 50	--	--	--	--		

Notes:

- 1 Requires branch circuit backup with a UL LISTED Type K5 or RK5 fuse (15A minimum) at no more than 4 times the rating of the protector.
- 2 Same as note 1, except that backup fuse is limited to 80A maximum.
- 3 2 pole protector required (with one pole per power line) for: 250/125 VAC, 125/250 VAC and 208Y/120 VAC Power Systems. 1 pole protector required for : 125 VAC, 1Ø Power System.
- 4 Satisfies the requirements of clause 11.2.8.2.5 of CSA STD C22.2 No 100 for the use of supplementary protectors with portable generators.

Electrical Tables

**Table B:** Lists UL Recognized, CSA, VDE & TUV Certified configurations & performance capabilities as a Component Supplementary Protector.

B-SERIES TABLE B: COMPONENT SUPPLEMENTARY PROTECTORS														
CIRCUIT CONFIGURATION	VOLTAGE			CURRENT RATING		SHORT CIRCUIT CAPACITY (AMPS)						APPLICATION CODES		CONSTRUCTION NOTES
	MAX. RATING	FREQUENCY	PHASE	FULL LOAD AMPS	GENERAL PURPOSE AMPS <sup>1</sup>	UL/CSA		VDE		TUV		UL	CSA	
						WITH BACKUP FUSE	WITHOUT BACKUP FUSE	(Inc) WITH BACKUP FUSE	(Inc) WITHOUT BACKUP FUSE	(Inc) WITH BACKUP FUSE	(Inc) WITHOUT BACKUP FUSE			
SERIES	80	DC	---	0.10 - 30	—	—	7500	3000	1500	3000	1500	TC1,2, OL1,U1	TC1,2, OL1,U1	
				31 - 50	31 - 50	—	7500	3000	1500	3000	1500	TC1,2, OL0,U1	TC1,2, OL0,U1	
				0.10 - 30	—	—	7500	3000	1500	3000	1500	TC1,2, OL1,U1	TC1,2, OL1,U1	
				31 - 32	—	—	7500	3000	1500	3000	1500	TC1,2, OL1,U1	TC1,2, OL1,U1	
				31 - 50	31 - 50	—	7500	3000	1500	3000	1500	TC1,2, OL0,U1	TC1,2, OL0,U1	
				0.10 - 30	—	—	3000	3000	1500	5000	1500	TC1,2, OL1,U1	TC1,2, OL1,U1	
	250	50 / 60	1	0.10 - 30	—	—	3000	—	—	5000	1500	TC1,2, OL0,U1	TC1,2, OL0,U1	
				31 - 50	31 - 50	—	3000	—	—	5000	1500	TC1,2, OL1,U1	TC1,2, OL1,U1	
				0.10 - 30	—	—	1500	3000	1500	5000	1500	TC1, OL0,U2	TC1, OL0,U2	Single Pole Break
				0.10 - 30	—	—	3000	3000	1500	5000	1500	TC1, OL1,U2	TC1, OL1,U2	Two Pole Break
				0.10 - 30	—	5000 <sup>3</sup>	—	3000	1500	3000	1500	TC1,2, OL1,C1	TC1,2, OL1,C1	
				0.10 - 30	—	—	1000	3000	1500	3000	1500	TC1,2, OL1,C1	TC1,2, OL1,C1	
DUAL COIL	80	DC	---	0.10 - 30	—	—	7500	3000	1500	3000	1500	TC1,2, OL1,U1	TC1,2, OL1,U1	
				0.10 - 30	—	—	3000	3000	1500	5000	1500	TC1,2, OL1,U1	TC1,2, OL1,U1	
				30 - 50	31 - 50	—	3000	—	—	5000	1500	TC1,2, OL0,U1	TC1,2, OL0,U1	
	250	50 / 60	1	0.10 - 30	—	5000 <sup>3</sup>	—	3000	1500	3000	1500	TC1,2, OL1,C1	TC1,2, OL1,C1	
				0.10 - 30	—	2000 <sup>2</sup>	—	—	—	3000	1500	TC1,2, OL1,C1	TC1,2, OL1,C1	
				31 - 50	—	—	—	—	—	3000	1500	TC1,2, OL1,C1	TC1,2, OL1,C1	
SHUNT	80	DC	---	0.10 - 30	—	—	7500	3000	1500	3000	1500	TC1,2, OL1,U1	TC1,2, OL1,U1	
				0.10 - 30	—	—	7500	3000	1500	3000	1500	TC1,2, OL1,U1	TC1,2, OL1,U1	
				0.10 - 30	—	—	3000	3000	1500	5000	1500	TC1,2, OL1,U1	TC1,2, OL1,U1	
	250	50 / 60	1	0.10 - 30	—	—	3000	—	—	5000	1500	TC1,2, OL0,U1	TC1,2, OL0,U1	
				30 - 50	31 - 50	—	3000	—	—	5000	1500	TC1,2, OL0,U1	TC1,2, OL0,U1	
				0.10 - 30	—	5000 <sup>3</sup>	—	3000	1500	3000	1500	TC1,2, OL1,C1	TC1,2, OL1,C1	
3	50 / 60	3	0.10 - 30	—	2000 <sup>2</sup>	—	—	—	3000	1500	TC1,2, OL1,C1	TC1,2, OL1,C1		
			31 - 50	—	—	—	—	—	3000	1500	TC1,2, OL1,C1	TC1,2, OL1,C1		

Notes:  
 1 General Purpose Ratings for UL/CSA Only.  
 2 Requires branch circuit backup with a UL LISTED Type K5 or RK5 fuse (15A minimum) at no more than 4 times the rating of the protector.  
 3 Same as note 1, except that backup fuse is limited to 80 A maximum.

**Table C:** Lists UL Recognized, CSA Certified configurations and performance capabilities as Protectors, Supplementary for Marine Electrical and Fuel Systems (CCN/Guide PEQZ2, File E75596). Ignition Protected per UL 1500. UL Classified Small Craft Electrical Devices, Marine in accordance with ISO 8846 (CCN/Guide UZMK, File MQ1515) as Marine Supplementary Protectors.

B-SERIES TABLE C: UL1500 (Marine Ignition Protected)							
CIRCUIT CONFIGURATION	VOLTAGE			CURRENT RATING	SHORT CIRCUIT CAPACITY (AMPS)	APPLICATION CODES	
	MAX. RATING	FREQUENCY	PHASE			FULL LOAD AMPS	WITHOUT BACKUP FUSE
SERIES	14 <sup>1</sup>	DC	—	0.02 - 50	5000	TC1,2,OL1,U1	TC1,2,OL1,U1
	32 <sup>1</sup>	DC	—	0.02 - 50	5000	TC1,2,OL1,U2	TC1,2,OL1,U2
	65	DC	—	0.02 - 50	3000	TC1,2,OL1,U1	TC1,2,OL1,U1
	125 / 250	50 / 60	1 <sup>2</sup>	0.02 - 50	1500	TC1,2,OL1,U1	TC1,2,OL1,U1
	250	50 / 60	1	0.02 - 30	1000	TC1,2,OL1,U1	TC1,2,OL1,U1

Notes:  
 1 Available with special catalog number only (consult factory).  
 2 2 pole protector required (with one pole per power line) for: 250/125 VAC, 125/250 VAC and 208Y/120 VAC Power Systems. 1 pole protector required for : 125 VAC, 1Ø Power System.

**Table D:** Lists UL Listed configurations and performance capabilities as Circuit Breakers for use in Communications Equipment (CCN/ Guide DITT, File E189195), under UL489A

B-SERIES TABLE D: UL489A (COMMUNICATIONS EQUIPMENT)				
CIRCUIT CONFIGURATION	VOLTAGE		CURRENT RATING	INTERRUPTING CAPACITY (AMPS)
	MAX. RATING	FREQUENCY	GENERAL PURPOSE AMPS	WITHOUT BACKUP FUSE
SERIES	80	DC	0.10 - 50	5000
	80	DC	60 - 90 <sup>1</sup>	5000

Notes:  
<sup>1</sup> Parallel Pole Construction

**Table E:** Lists UL Listed (489) configuration and performance capabilities as a Molded Case Circuit Breaker.

B SERIES TABLE E : UL489 LISTED BRANCH CIRCUIT BREAKERS						
CIRCUIT CONFIGURATION	VOLTAGE			CURRENT RATING	INTERRUPTING CAPACITY (AMPS)	CONSTRUCTION NOTES
	MAX. RATING	FREQUENCY	PHASE	FULL LOAD AMPS	WITHOUT BACKUP FUSE	
SERIES	120	50 / 60	1	0.10 - 30	5,000	1 Pole
	120 / 240	50 / 60	1	0.10 - 30	5,000	2 Poles
	120 / 240	50 / 60	1	0.10 - 30	5,000	2 or 3 Poles (1 Pole of a 3 Pole Unit is for Neutral Break)
SHUNT TRIP DUAL COIL	120	50 / 60	1	0.10 - 30	5,000	1 Pole
	120 / 240	50 / 60	1	0.10 - 30	5,000	2 Poles
	120 / 240	50 / 60	1	0.10 - 30	5,000	2 or 3 Poles (1 Pole of a 3 Pole Unit is for Neutral Break)

### Agency Certifications

**UL Recognized**

UL Standard 1077



Component Recognition Program as Protectors Supplementary (Guide CCN/QVNU2, File E75596)

**CSA Accepted**



Component Supplementary Protector under Class 3215 30, File 047848 0 000 CSA Standard C22.2 No. 235

UL Standard 508



Switches, Industrial Control (Guide CCN/NRNT2, File E148683)

**TUV Certified**



EN60934, under License No. R72103448

UL Standard 1500



Protectors, Supplementary for Marine Electrical & Fuel Systems (Guide PEQZ2, File E75596) Ignition Protection

**VDE Certified**



EN60934, VDE 0642 under File No. 10537

**UL Listed**

UL Standard 489



Circuit Breakers, Molded Case, (Guide DIVQ, File E129899)

UL Standard 489A

Communications Equipment (Guide CCN/DITT, File E189195)

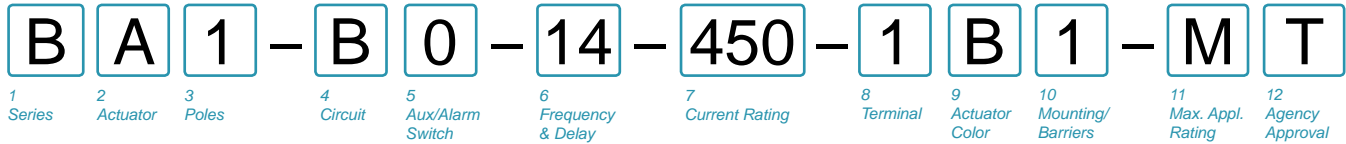

**1 SERIES**  
B

**2 ACTUATOR** <sup>1</sup>

- A Handle, one per pole
- B Handle, one per multipole unit
- S Mid-Trip Handle, one per pole
- T Mid-Trip Handle, one per pole & Alarm Switch

**3 POLES** <sup>2</sup>

- 1 One
- 3 Three
- 2 Two
- 4 Four

**4 CIRCUIT**

- B Series Trip (Current)

**5 AUXILIARY / ALARM SWITCH** <sup>2</sup>

- 0 without Aux Switch
- 7 S.P.S.T., 0.110 Q.C. Term. (Gold Contacts)
- 1 S.P.D.T., 0.093 Q.C. Term.
- 8 S.P.S.T., 0.187 Q.C. Term.
- 2 S.P.D.T., 0.110 Q.C. Term.
- 9 S.P.D.T., 0.187 Q.C. Term.
- 3 S.P.D.T., 0.110 Solder Lug

**6 FREQUENCY & DELAY** <sup>4</sup>

- 11 DC Ultra Short
- 52 DC, Short, Hi-Inrush
- 12 DC Short
- 54 DC, Medium, Hi-Inrush
- 14 DC Medium
- 56 DC, Long, Hi-Inrush
- 16 DC Long

**7 CURRENT RATING (AMPERES)**

CODE	AMPERES						
210	0.100	285	0.850	455	5.500	613	13.000
215	0.150	290	0.900	460	6.000	614	14.000
220	0.200	295	0.950	465	6.500	615	15.000
225	0.250	410	1.000	470	7.000	616	16.000
230	0.300	512	1.250	475	7.500	617	17.000
235	0.350	415	1.500	480	8.000	618	18.000
240	0.400	517	1.750	485	8.500	620	20.000
245	0.450	420	2.000	490	9.000	622	22.000
250	0.500	522	2.250	495	9.500	624	24.000
255	0.550	527	2.750	610	10.000	625	25.000
260	0.600	430	3.000	710	10.500	630	30.000
265	0.650	435	3.500	611	11.000	635	<sup>3</sup> 35.000
270	0.700	440	4.000	711	11.500	640	<sup>3</sup> 40.000
275	0.750	445	4.500	612	12.000	645	<sup>3</sup> 45.000
280	0.800	450	5.000	712	12.500	650	<sup>3</sup> 50.000

**8 TERMINAL** <sup>4</sup>

- 1 <sup>5</sup> Push-On 0.250 Tab (Q.C.)
- B Screw M5 with upturned lugs & 30° bend
- 2 Screw 8-32 with upturned lugs
- F Screw M5 with upturned lugs & 30° bend
- 3 <sup>6</sup> Screw 8-32 (Bus Type)
- G Screw M5 (Bus Type) & 30° bend
- 4 Screw 10-32 with upturned lugs
- H Screw M5 (Bus Type)
- 5 <sup>6</sup> Screw 10-32 (Bus Type)
- J Screw M5 Back Connect
- 6 Screw 8-32 with upturned lugs & 30° bend
- K Screw 10-32 Back Connect
- 7 Screw 8-32 (Bus Type) & 30° bend
- M <sup>6</sup> M6 Threaded Stud
- 8 Screw 10-32 with upturned lugs & 30° bend
- N Screw M4 Back Connect
- 9 Screw 10-32 (Bus Type) & 30° bend
- P <sup>7</sup> Printed Circuit Board Terminals
- Y Screw 8-32 Back Connect
- Q <sup>8</sup> Push-In Stud

**9 ACTUATOR COLOR & LEGEND**

Actuator Color	ON-OFF	Dual	Legend Color
White	B	1	Black
Black	D	2	White
Red	G	3	White
Green	J	4	White
Blue	L	5	White
Yellow	N	6	Black
Gray	Q	7	Black
Orange	S	8	Black

**10 MOUNTING / BARRIERS**

MOUNTING STYLE	BARRIERS
<b>Threaded Insert, 2 per pole</b>	
1 6-32 x 0.195 inches	no
A 6-32 x 0.195 inches (multi-pole units only)	yes
2 ISO M3 x 5mm	no
B ISO M3 x 5mm	yes
<b>Rectangular Adapter Plate with mounting centers of 2.062 inches [52.37mm] and Threaded insert, 2 per pole</b>	
3 6-32 x 0.225 inches	no
C 6-32 X 0.225 inches (multi-pole units only)	yes
4 ISO M3 x 6.5mm	no
D ISO M3 x 6.5mm	yes
<b>Front panel Snap-In, 0.75" [19.05mm] wide bezel</b>	
5 without Handleguard	no
6 without Handleguard (multipole only)	yes
<b>Front panel Snap-In, 0.96" wide bezel</b>	
7 without Handleguard, 1-pole 0.96" wide;	no
8 without Handleguard, 1-pole 0.96" wide;	yes
(multipole only) .105" bezel overhang on all sides	

**11 MAXIMUM APPLICATION RATING**

- M 80 DC

**12 AGENCY APPROVAL**

- T UL489A Listed
- K UL489A Listed, VDE Certified
- J UL489A Listed, TUV Certified

Notes:

- 1 Actuator Code:  
A: Handle tie pin spacer(s) and retainers provided unassembled with multi-pole units.  
S: Handle moves to mid-position only upon electrical trip of the breaker.  
T: Handle moves to mid-position and alarm switch activates only upon electrical trip of the breaker.
- 2 On multi-pole breakers, one auxiliary switch is supplied, mounted in the extreme right pole.
- 3 VDE Certification available with single pole breakers only. UL489A Listing available with one and two pole breakers.
- 4 Screw Terminals are recommended on ratings greater than 20 amps. Ratings over 30 amps are only available with Terminal Codes 5, 9, G, H, J, K, M and Q.
- 5 Terminal Code 1 (Push-On) available up to 25 amps with TUV or VDE Certification and 30 amps with UL489A Listing, but is not recommended over 20 amps.
- 6 Terminal Codes 3, 5 and H (Bus Type) with TUV or VDE, are supplied with Lock Washers, and Terminal Code M (M6 Threaded Stud) with TUV or VDE is supplied with Lock and Flat Washers. These breakers are only TUV or VDE Certified when the washers are used.
- 7 Single pole breakers with Terminal Code P (Printed Circuit Board) are available up to 30 amps with VDE Certification and 50 amps with UL489A Listing.
- 8 Terminal Code Q not available with VDE approvals.

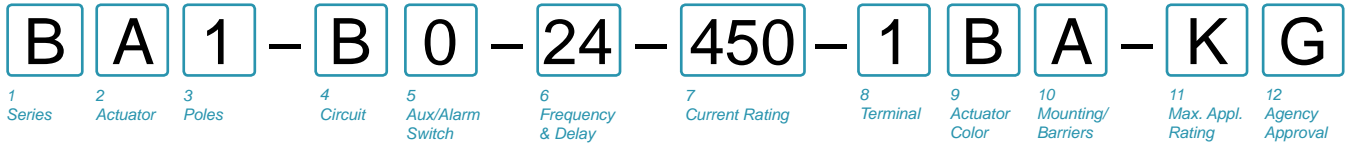

**1 SERIES**  
**B**

**2 ACTUATOR <sup>1</sup>**  
**A** Handle, one per pole  
**B** Handle, one per multipole unit  
**S** Mid-Trip Handle, one per pole  
**T** Mid-Trip Handle, one per pole & Alarm Switch

**3 POLES <sup>2</sup>**  
**1** One                      **2** Two                      **3**<sup>3</sup> Three

**4 CIRCUIT**  
**B** Series Trip (Current)

**5 AUXILIARY / ALARM SWITCH <sup>4</sup>**  
**0** without Aux Switch                      **3** S.P.D.T., 0.110 Solder Lug  
**1** S.P.D.T., 0.093 Q.C. Term.              **8** S.P.S.T., 0.187 Q.C. Term.  
**2** S.P.D.T., 0.110 Q.C. Term.              **9** S.P.D.T., 0.187 Q.C. Term.

**6 FREQUENCY & DELAY**  
**21** AC Ultra Short                      **42** AC, Short, Hi-Inrush  
**22** AC Short                                  **44** AC, Medium, Hi-Inrush  
**24** AC Medium                              **46** AC, Long, Hi-Inrush  
**26** AC Long

**7 CURRENT RATING (AMPERES)**

CODE	AMPERES				
210	0.100	280	0.800	445	4.500
215	0.150	285	0.850	450	5.000
220	0.200	290	0.900	455	5.500
225	0.250	295	0.950	460	6.000
230	0.300	410	1.000	465	6.500
235	0.350	512	1.250	470	7.000
240	0.400	415	1.500	475	7.500
245	0.450	517	1.750	480	8.000
250	0.500	420	2.000	485	8.500
255	0.550	522	2.250	490	9.000
260	0.600	527	2.750	495	9.500
265	0.650	430	3.000	610	10.000
270	0.700	435	3.500	710	10.500
275	0.750	440	4.000	611	11.000
				630	30.000

**8 TERMINAL <sup>4</sup>**

<b>1</b>	Push-On 0.250 Tab (Q.C.)	<b>A</b>	Load Terminal #8 Screw with QC Combination (Special Catalog #)
<b>2</b>	Screw 8-32 with upturned lugs	<b>B</b>	Screw M5 with upturned lugs
<b>3</b>	Screw 8-32 (Bus Type)		& 30° bend
<b>4</b>	Screw 10-32 with upturned lugs	<b>F</b>	Screw M5 with upturned lugs
<b>5</b>	Screw 10-32 (Bus Type)		& 30° bend
<b>6</b>	Screw 8-32 with upturned lugs & 30° bend	<b>G</b>	Screw M5 (Bus Type) & 30° bend
<b>7</b>	Screw 8-32 (Bus Type) & 30° bend	<b>H</b>	Screw M5 (Bus Type)
<b>8</b>	Screw 10-32 with upturned lugs & 30° bend	<b>J</b>	Screw M5 Back Connect
<b>9</b>	Screw 10-32 (Bus Type) & 30° bend	<b>K</b>	Screw 10-32 Back Connect
		<b>M</b>	M6 Threaded Stud
		<b>N</b>	Screw M4 Back Connect
		<b>Q</b>	Push-In Stud
		<b>Y</b>	Screw 8-32 Back Connect

**9 ACTUATOR COLOR & LEGEND <sup>6</sup>**

Actuator Color	ON-OFF	Dual	Legend Color
White	<b>B</b>	<b>1</b>	Black
Black	<b>D</b>	<b>2</b>	White
Red	<b>G</b>	<b>3</b>	White
Green	<b>J</b>	<b>4</b>	White
Blue	<b>L</b>	<b>5</b>	White
Yellow	<b>N</b>	<b>6</b>	Black
Gray	<b>Q</b>	<b>7</b>	Black
Orange	<b>S</b>	<b>8</b>	Black

**10 MOUNTING / BARRIERS**

	MOUNTING STYLE	BARRIERS
	<b>Threaded Insert, 2 per pole</b>	
<b>A</b>	6-32 x 0.195 inches (multi-pole units only)	yes
<b>B</b>	ISO M3 x 5mm	yes
	<b>Rectangular Adapter Plate with mounting centers of 2.062 inches [52.37mm] and Threaded insert, 2 per pole <sup>7</sup></b>	
<b>C</b>	6-32 X 0.225 inches (multi-pole units only)	yes
<b>D</b>	ISO M3 x 6.5mm	yes
<b>6</b>	<b>Front panel Snap-In, 0.75" [19.05mm] wide bezel without Handleguard (multipole only)</b>	yes
<b>8</b>	<b>Front panel Snap-In, 0.96" wide bezel without Handleguard, 1-pole 0.96" wide; (multipole only) .105" bezel overhang on all sides</b>	yes

**11 MAXIMUM APPLICATION RATING**  
**C**<sup>8</sup> 120/240VAC  
**K** 120VAC

**12 AGENCY APPROVAL**  
**G** UL489 Listed  
**3** UL489 Listed, TUV Certified

- Notes:
- Actuator Code:  
 A: Handle tie pin spacer(s) and retainers provided un-assembled with multi-pole units.  
 B: Handle location as viewed from front of breaker:  
     2 pole - left pole                      3 pole - center pole  
 S: Handle moves to mid-position only upon electrical trip of the breaker. Available with circuit codes B, C, D, E, F, G, H and K.  
 T: Handle moves to mid-position and alarm switch activates only upon electrical trip of the breaker. Available with circuit codes B & C.
  - All poles must be same polarity.
  - 3 pole units available only when 1 of 3 poles is neutral.
  - Auxiliary/Alarm Switch circuit must be same polarity as the main circuit. On multi-pole breakers, one auxiliary switch is supplied, mounted in the extreme right pole.
  - Screw Terminals are recommended on ratings greater than 20 amps.
  - Standard actuator colors are black and white.
  - Adapter plate with mounting centers of 2.082 inches. Available with Actuator Codes A, S and T.
  - Voltage Rating available with 2 and 3-pole breakers only.
  - Barriers supplied on multi-pole units only.

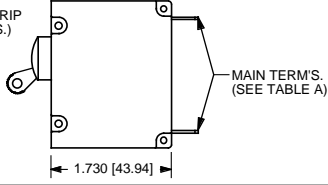
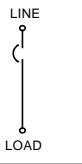
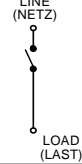
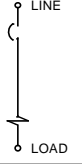
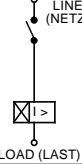
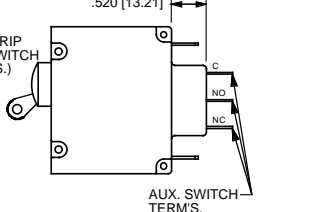
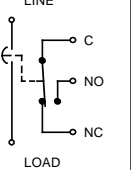
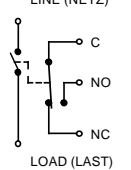
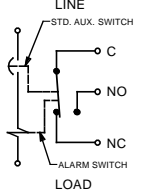
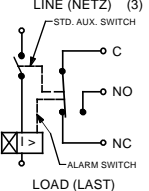
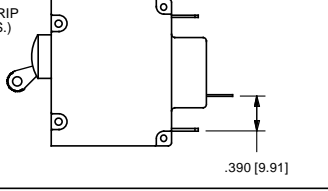
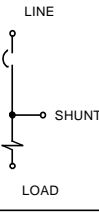
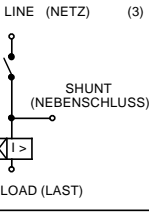
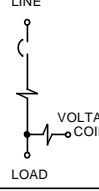
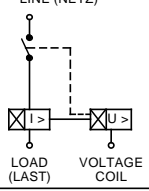
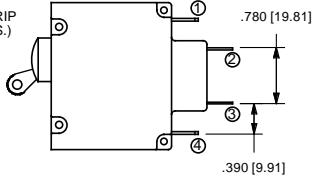
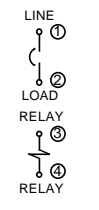
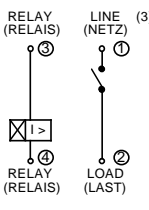
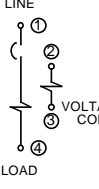
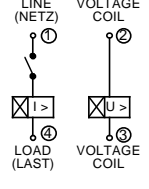

### Circuit & Terminal Diagrams: in. [mm]

	CIRCUIT SCHEMATIC		CIRCUIT CODE	SWITCH CODE	CIRCUIT SCHEMATIC		CIRCUIT CODE	AUX. SWITCH CODE
	ANSI	IEC			ANSI	IEC		
<b>SERIES TRIP (2 TERM.S.)</b> 	<b>SWITCH ONLY (NO COIL)</b>  		A	O	<b>SERIES TRIP</b>  		B C	O
<b>SERIES TRIP W AUX SWITCH (5 TERM.S.)</b> 	<b>SWITCH ONLY (NO COIL) WITH AUXILIARY SWITCH</b>  		A	2 3 4	<b>SERIES TRIP WITH AUXILIARY / ALARM SWITCH</b>  		B C	2 3 4
<b>SHUNT TRIP (3 TERM.S.)</b> 	<b>SHUNT TRIP</b>  		D E	0	<b>DUAL COIL; SERIES TRIP CURRENT COIL, SHUNT TRIP VOLTAGE COIL</b>  		H	0
<b>RELAY TRIP (4 TERM.S.)</b> 	<b>RELAY TRIP</b>  		F G	0	<b>DUAL COIL; SERIES TRIP CURRENT COIL, RELAY TRIP VOLTAGE COIL</b>  		K	0

CIRCUIT BREAKER MODE	STANDARD C/B		MID TRIP C/B		MID TRIP C/B	
	HANDLE POSITION	AUX. SWITCH MODE	HANDLE POSITION	ALARM SWITCH MODE	HANDLE POSITION	AUX. SWITCH MODE (w/o ALARM SWITCH)
OFF						
ON						
ELECTRICAL TRIP						

- Notes:  
 1 All dimensions are in inches [millimeters].  
 2 Tolerance ±.020 [.51] unless otherwise specified.  
 3 Alarm Switch available with .110 x .020 Q.C. & Solder Lug Terminals Only.

## Circuit & Terminal Diagrams: in. [mm]

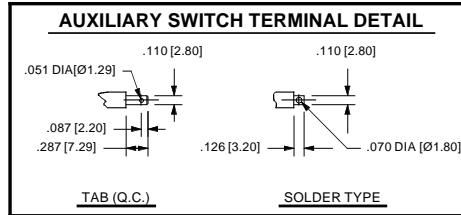
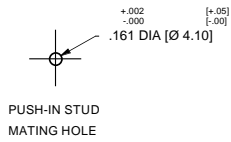
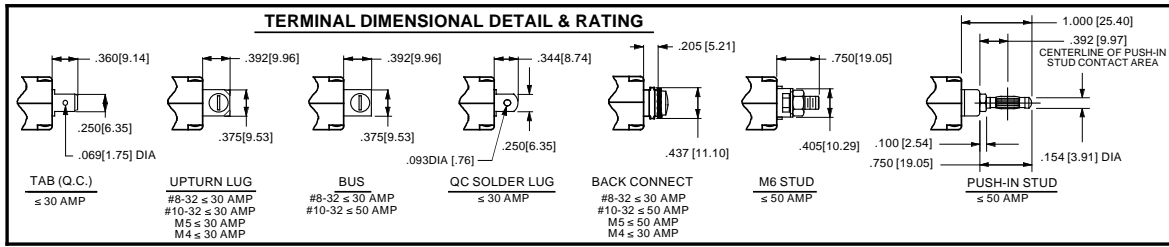

**TABLE A  
TIGHTENING TORQUE SPECIFICATIONS**

THREAD SIZE	TORQUE
#6-32 & M3 MOUNTING HARDWARE	7-9 IN-LBS [0.8-1.0 NM]
#8-32 & M4 THREAD TERMINAL SCREW	12-15 IN-LBS [1.4-1.7 NM]
#10-32 & M5 THREAD TERMINAL SCREW	15-20 IN-LBS [1.7-2.3 NM]

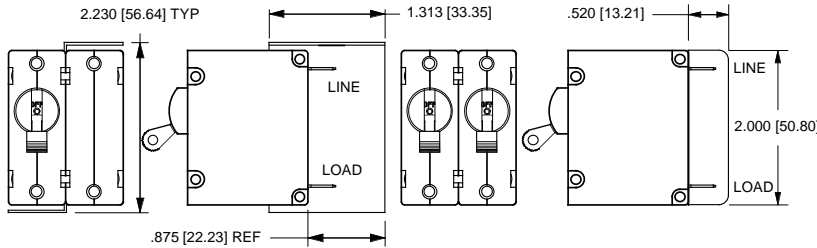

**BARRIER FOR  
UL-489 MULTI-POLE  
BREAKERS**

**BARRIER FOR  
UL-RECOGNIZED MULTI-POLE  
BREAKERS**

**TABLE B**

TERMINAL DESCRIPTION	DEPTH BEHIND PANEL
MAIN TAB (Q.C.)	2.090 [53.09]
MAIN SCREW TYPE	2.122 [53.90]
SHUNT, RELAY & DUAL COIL TAB (Q.C.)	2.612 [66.35]
SHUNT, RELAY & DUAL COIL SCREW #8-32 W/UPTURNED LUGS	2.644 [67.16]
AUX. SWITCH* TAB (Q.C.) .110 x .020	2.537 [64.44]
AUX. SWITCH* SOLDER TYPE	2.348 [59.64]

\* AVAILABLE ON SERIES TRIP AND SWITCH ONLY CIRCUITS. WHEN CALLED FOR ON MULTI-POLE UNITS, ONLY ONE AUX. SWITCH IS NORMALLY SUPPLIED, AS SHOWN IN MULTI-POLE IDENTIFICATION SCHEME.

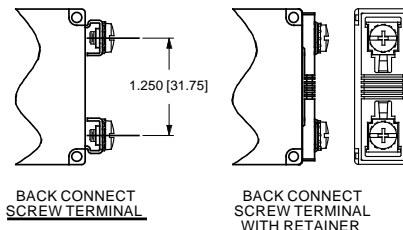
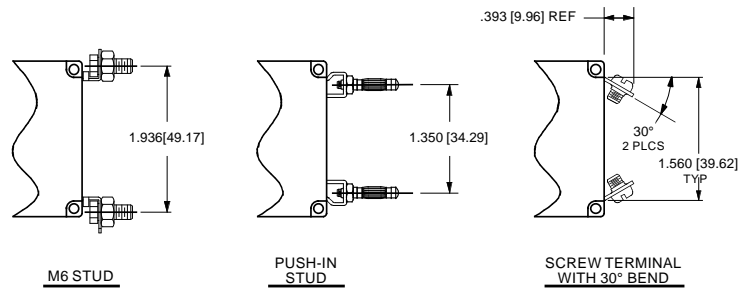
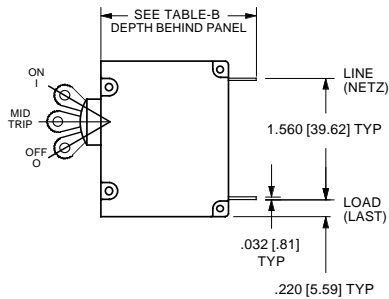

Notes:

- All dimensions are in inches [millimeters].
- Tolerance ±0.020 [.51] unless otherwise specified.

## Dimensional Specifications: in. [mm]

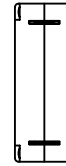
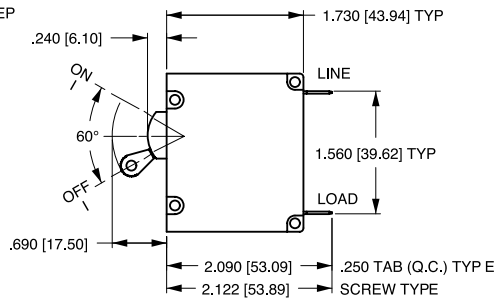
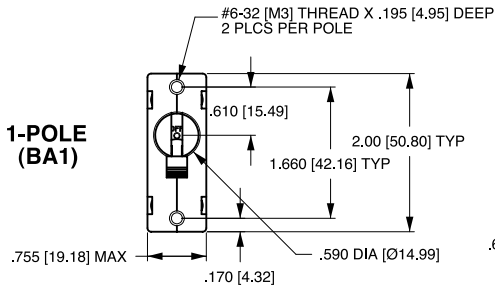

TAB (Q.C.) TYPE TERMINALS IN SERIES TRIP CIRCUIT CONFIGURATION SHOWN. FOR OTHER CONFIGURATIONS, SEE CIRCUIT AND TERMINAL DRAWINGS.

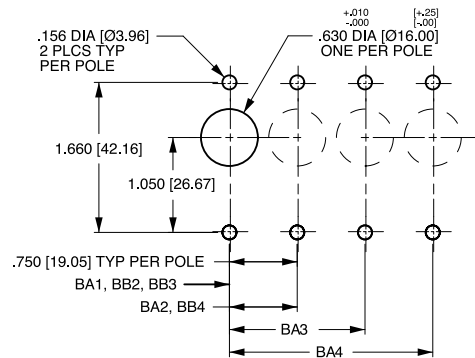
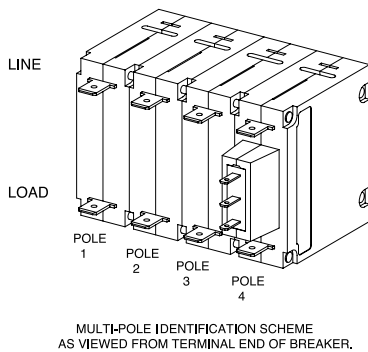
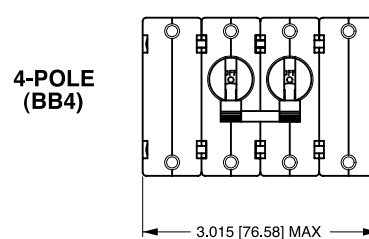
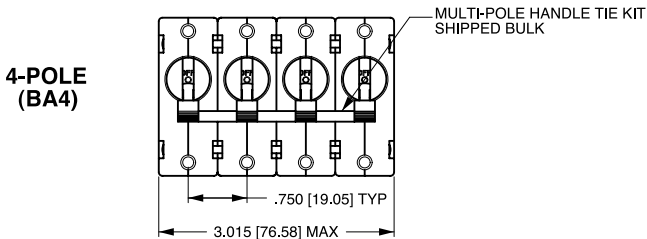
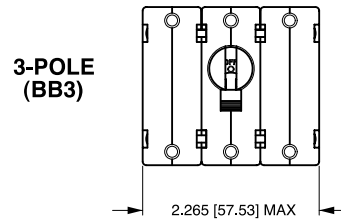
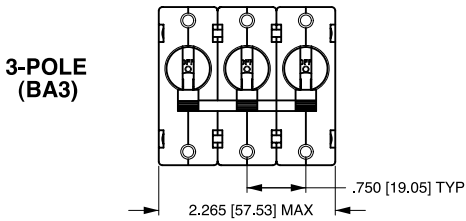
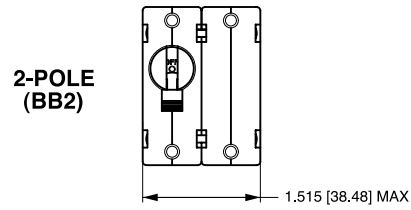
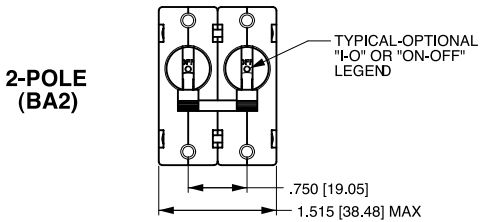

- Notes:
- 1 All dimensions are in inches [millimeters].
  - 2 Tolerance ± 0.20 [ .51 ] unless otherwise specified.

### Dimensional Specifications: in. [mm]

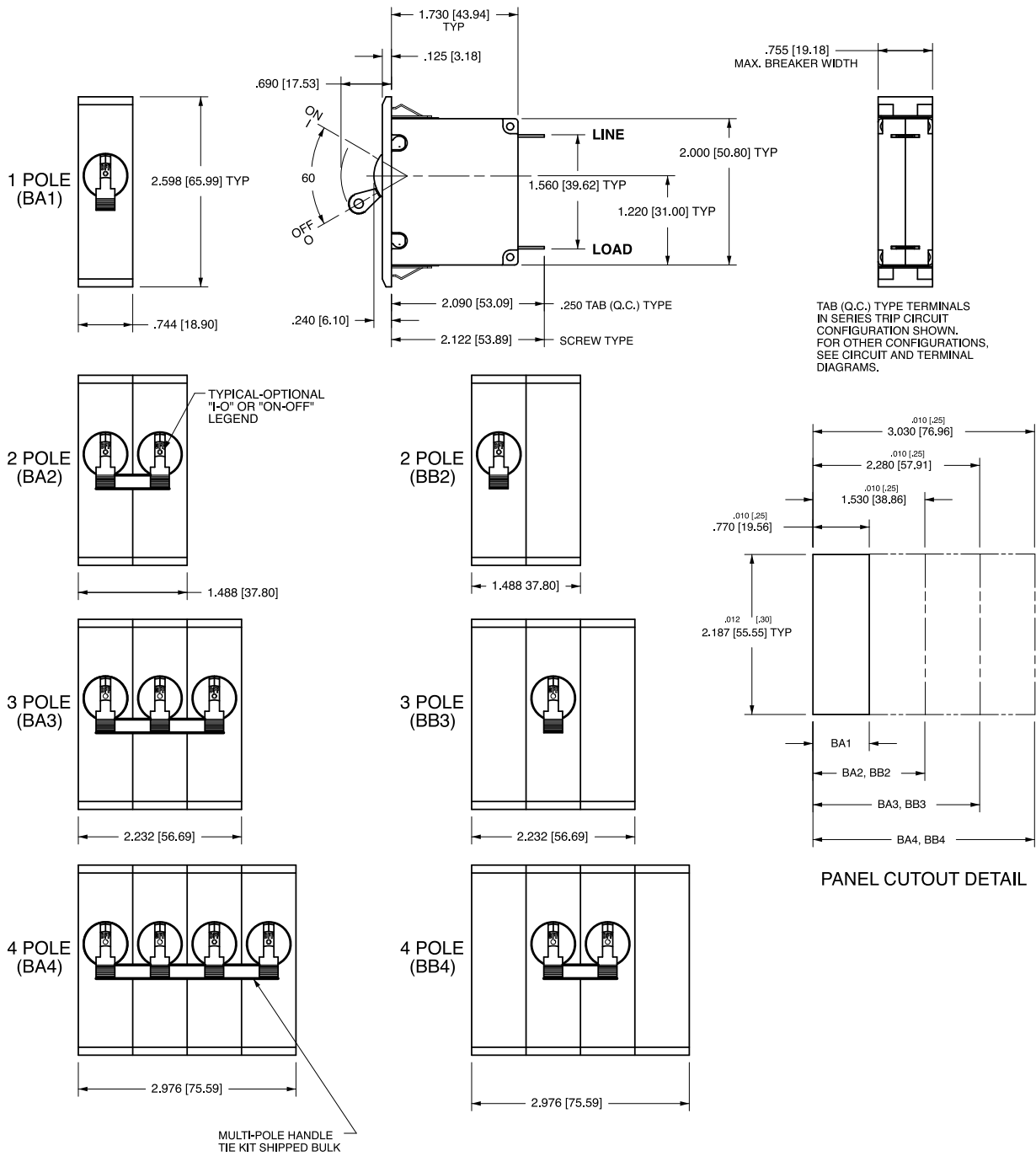

- Notes:  
 1 All dimensions are in inches [millimeters].  
 2 Recommended panel thickness: .040 [1.02] to .100 [2.54].  
 3 Tolerance ±.020 [.51] unless otherwise specified.

## Dimensional Specifications: in. [mm]

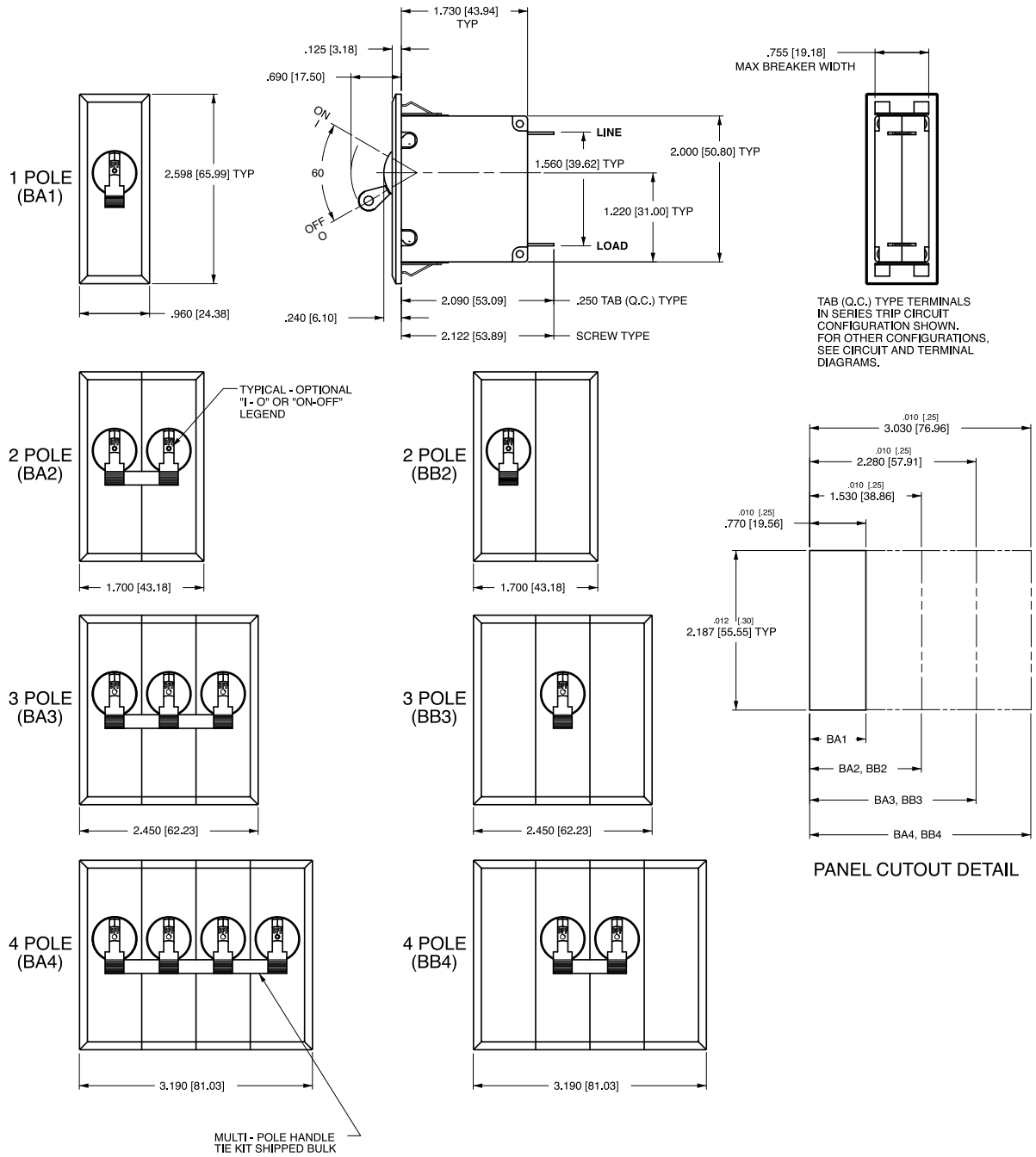

- Notes:  
 1 All dimensions are in inches [millimeters].  
 2 Recommended panel thickness: .040 [1.02] to .100 [2.54].  
 3 Tolerance ±.020 [.51] unless otherwise specified.

**B F 1 - B 0 - 24 - 630 - 2 3 A - K G**

1 Series    2 Actuator    3 Poles    4 Circuit    5 Aux/Alarm Switch    6 Frequency & Delay    7 Current Rating    8 Terminal    9 Actuator Color    10 Mounting/Barriers    11 Max. Appl. Rating    12 Agency Approval

**1 SERIES**  
B

**2 ACTUATOR**

**Two Color Visi-Rocker**

- C** Indicate ON, vertical legend      **J** Vertical legend  
**D** Indicate ON, horizontal legend    **K** Horizontal legend  
**F** Indicate OFF, vertical legend  
**G** Indicate OFF, horizontal legend

**Single color**

- J** Vertical legend  
**K** Horizontal legend

**ROCKER STYLE DESCRIPTIONS**

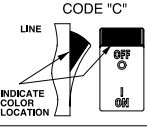
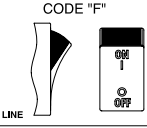
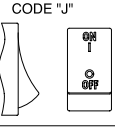
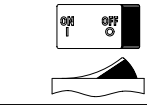
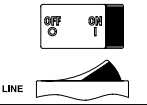
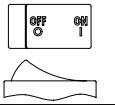
	INDICATE "ON"	INDICATE "OFF"	SINGLE COLOR
<b>VERTICAL STYLE</b>	<p>CODE "C"</p>  <p>INDICATE COLOR LOCATION</p>	<p>CODE "F"</p> 	<p>CODE "J"</p> 
<b>HORIZONTAL STYLE</b>	<p>CODE "D"</p> 	<p>CODE "G"</p> 	<p>CODE "K"</p> 

**3 POLES 1,2**

- 1 One                      2 Two                      3<sup>3</sup> Three

**4 CIRCUIT**

- B** Series Trip (Current)

**5 AUXILIARY / ALARM SWITCH 4**

- 0** without Aux Switch      **7** S.P.S.T., 0.110 Q.C. Term.  
**1** S.P.D.T., 0.093 Q.C. Term. (Gold Contacts)  
**2** S.P.D.T., 0.110 Q.C. Term.      **8** S.P.S.T., 0.187 Q.C. Term.  
**3** S.P.D.T., 0.110 Solder Lug      **9** S.P.D.T., 0.187 Q.C. Term.

**6 FREQUENCY & DELAY**

- 21** AC Ultra Short                      **42** AC, Short, Hi-Inrush  
**22** AC Short                              **44** AC, Medium, Hi-Inrush  
**24** AC Medium                          **46** AC, Long, Hi-Inrush  
**26** AC Long

**7 CURRENT RATING (AMPERES)**

CODE	AMPERES	CODE	AMPERES	CODE	AMPERES	CODE	AMPERES
020	0.020	220	0.200	415	1.500	495	9.500
025	0.025	225	0.250	517	1.750	610	10.000
030	0.030	230	0.300	420	2.000	710	10.500
035	0.035	235	0.350	522	2.250	611	11.000
040	0.040	240	0.400	527	2.750	711	11.500
045	0.045	245	0.450	430	3.000	612	12.000
050	0.050	250	0.500	435	3.500	712	12.500
055	0.055	255	0.550	440	4.000	613	13.000
060	0.060	260	0.600	445	4.500	614	14.000
065	0.065	265	0.650	450	5.000	615	15.000
070	0.070	270	0.700	455	5.500	616	16.000
075	0.075	275	0.750	460	6.000	617	17.000
080	0.080	280	0.800	465	6.500	618	18.000
085	0.085	285	0.850	470	7.000	620	20.000
090	0.090	290	0.900	475	7.500	622	22.000
095	0.095	295	0.950	480	8.000	624	24.000
210	0.100	410	1.000	485	8.500	625	25.000
215	0.150	512	1.250	490	9.000	630	30.000

**8 TERMINAL 5**

- 1**<sup>6</sup> Push-On 0.250 Tab (Q.C.)      **B** Screw M5 with upturned lugs  
**2** Screw 8-32 with upturned lugs    **C** Screw M4 with upturned lugs  
**3** Screw 8-32 (Bus Type)      **F** Screw M5 with upturned lugs & 30° bend  
**4** Screw 10-32 with upturned lugs    **G** Screw M5 (Bus Type) & 30° bend  
**5** Screw 10-32 (Bus Type)      **H** Screw M5 (Bus Type)  
**6** Screw 8-32 with upturned lugs & 30° bend    **J** Screw M5 Back Connect  
**7** Screw 8-32 (Bus Type) & 30° bend    **K** Screw 10-32 Back Connect  
**8** Screw 10-32 with upturned lugs & 30° bend    **N** Screw M4 Back Connect  
**9** Screw 10-32 (Bus Type) & 30° bend    **Y** Screw 8-32 Back Connect

**9 ACTUATOR COLOR & LEGEND**

Actuator or Visi-Rocker 7	Marking:		Marking Color	
	ON-OFF	Dual 7	Single Color	Visi-Rocker
White	B	1	Black	White
Black	D	2	White	n/a
Red	G	3	White	Red
Green	J	4	White	Green
Blue	L	5	White	Blue
Yellow	N	6	Black	Yellow
Gray	Q	7	Black	Gray
Orange	S	8	Black	Orange

**10 MOUNTING / BARRIERS**

- MOUNTING STYLE**                                              **BARRIERS 9**  
**Threaded Insert, 2 per pole**  
**A** 6-32 x 0.195 inches (*multi-pole units only*)      yes  
**B** ISO M3 x 5mm                                              yes  
**ROCKERGUARD BEZEL**  
**Threaded Insert, 2 per pole**  
**C** 6-32 X 0.225 inches (*multi-pole units only*)      yes  
**D** ISO M3 x 6.5mm                                              yes

**11 MAXIMUM APPLICATION RATING**

- C**<sup>8</sup> 120/240 VAC  
**K** 120 VAC

**12 AGENCY APPROVAL**

- G** UL489 Listed  
**3** UL489 Listed, TUV Certified

Notes:

- 1 Multi-pole breakers have all breakers identical except when specifying Auxiliary switch and/or mixed poles, and have one rocker per breaker.  
2 All poles must be same polarity.  
3 3 pole units available only when 1 of 3 poles is neutral.  
4 On multi-pole breakers, one auxiliary switch is supplied, mounted in the extreme right pole.  
5 Screw Terminals are recommended on ratings greater than 20 amps.  
6 Terminal Code 1 (Push-On) available up to 30 amps, but are not recommended over 20 amps.  
7 Dual Legend = ON-OFF/I-O  
8 Voltage Rating available with 2 and 3-pole breakers only.  
9 Barriers supplied on multi-pole units only.

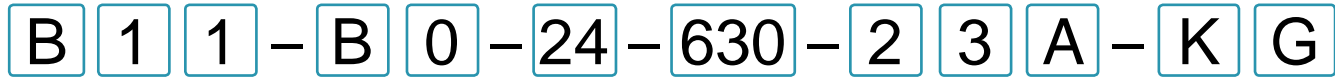

1 Series    2 Actuator    3 Poles    4 Circuit    5 Aux/Alarm Switch    6 Frequency & Delay    7 Current Rating    8 Terminal    9 Actuator Color    10 Mounting/Barriers    11 Max. Appl. Rating    12 Agency Approval

**1 SERIES**  
B

**2 ACTUATOR 1**  
**Two Color Visi-Rocker**  
 1 Indicate OFF, vertical legend  
 2 Indicate OFF, horizontal legend  
**Single color**  
 3 Vertical legend  
 4 Horizontal legend  
**Push-To-Reset, Visi-Rocker**  
 5 Indicate OFF, vertical legend  
 6 Indicate OFF, horizontal legend  
**Push-To-Reset , Single color**  
 7 Vertical legend  
 8 Horizontal legend

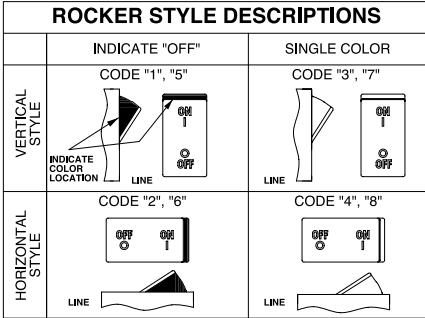

**3 POLES 2,3**  
 1 One                      2 Two                      3<sup>4</sup> Three

**4 CIRCUIT**  
 B Series Trip (Current)

**5 AUXILIARY / ALARM SWITCH 4**  
 0 without Aux Switch                      7 S.P.S.T., 0.110 Q.C. Term.  
 1 S.P.D.T., 0.093 Q.C. Term.                      (Gold Contacts)  
 2 S.P.D.T., 0.110 Q.C. Term.                      8 S.P.S.T., 0.187 Q.C. Term.  
 3 S.P.D.T., 0.110 Solder Lug                      9 S.P.D.T., 0.187 Q.C. Term.

**6 FREQUENCY & DELAY**  
 21 AC Ultra Short                      42 AC, Short, Hi-Inrush  
 22 AC Short                      44 AC, Medium, Hi-Inrush  
 24 AC Medium                      46 AC, Long, Hi-Inrush  
 26 AC Long

**7 CURRENT RATING (AMPERES)**

CODE	AMPERES				
020	0.020	220	0.200	415	1.500
025	0.025	225	0.250	517	1.750
030	0.030	230	0.300	420	2.000
035	0.035	235	0.350	522	2.250
040	0.040	240	0.400	527	2.750
045	0.045	245	0.450	430	3.000
050	0.050	250	0.500	435	3.500
055	0.055	255	0.550	440	4.000
060	0.060	260	0.600	445	4.500
065	0.065	265	0.650	450	5.000
070	0.070	270	0.700	455	5.500
075	0.075	275	0.750	460	6.000
080	0.080	280	0.800	465	6.500
085	0.085	285	0.850	470	7.000
090	0.090	290	0.900	475	7.500
095	0.095	295	0.950	480	8.000
100	0.100	300	1.000	485	8.500
110	0.110	310	1.100	490	9.000
120	0.120	320	1.200		
150	0.150	350	1.500		
200	0.200	400	2.000		
250	0.250	450	2.500		
300	0.300	500	3.000		
400	0.400	600	4.000		
500	0.500	700	5.000		
600	0.600	800	6.000		
700	0.700	900	7.000		
800	0.800	1000	8.000		
900	0.900	1100	9.000		
1000	1.000	1200	10.000		

**8 TERMINAL 6**  
 1<sup>7</sup> Push-On 0.250 Tab (Q.C.)                      B Screw M5 with upturned lugs  
 2 Screw 8-32 with upturned lugs                      C Screw M4 with upturned lugs  
 3 Screw 8-32 (Bus Type)                      F Screw M5 with upturned lugs & 30° bend  
 4 Screw 10-32 with upturned lugs                      G Screw M5 (Bus Type) & 30° bend  
 5 Screw 10-32 (Bus Type)                      H Screw M5 (Bus Type)  
 6 Screw 8-32 with upturned lugs & 30° bend                      J Screw M5 Back Connect  
 7 Screw 8-32 (Bus Type) & 30° bend                      K Screw 10-32 Back Connect  
 8 Screw 10-32 with upturned lugs & 30° bend                      N Screw M4 Back Connect  
 9 Screw 10-32 (Bus Type) & 30° bend                      Y Screw 8-32 Back Connect

**9 ACTUATOR COLOR & LEGEND**

Actuator or Visi-Color <sup>8</sup>	Marking:		Marking Color	
	ON-OFF	Dual <sup>8</sup>	Single Color	Visi-Rocker
White	B	1	Black	White
Black	D	2	White	n/a
Red	G	3	White	Red
Green	J	4	White	Green
Blue	L	5	White	Blue
Yellow	N	6	Black	Yellow
Gray	Q	7	Black	Gray
Orange	S	8	Black	Orange

**10 MOUNTING / BARRIERS 9**  
**STANDARD ROCKER BEZEL**                      BARRIERS<sup>12</sup>  
**Threaded Insert, 2 per pole**  
**FLAT ROCKER ACTUATOR**  
 A 6-32 x 0.195 inches (*multi-pole units only*)                      yes  
 B ISO M3 x 5mm                      yes  
**RECESSED OFF SIDE ROCKER ACTUATOR<sup>10</sup>**  
 E 6-32 X 0.225 inches (*multi-pole units only*)                      yes  
 F ISO M3 x 6.5mm                      yes  
**PUSH-TO-RESET BEZEL, Threaded Insert, 2 per pole**  
 C 6-32 x 0.195 inches                      yes  
 D ISO M3 x 5mm                      yes

**11 MAXIMUM APPLICATION RATING**  
 C<sup>11</sup> 120/240 VAC  
 K 120 VAC

**12 AGENCY APPROVAL**  
 G UL489 Listed  
 3 UL489 Listed, TUV Certified

- Notes:
- 1 Push-To-Reset actuators have OFF portion of rocker shrouded.
  - 2 Multi-pole breakers have all breakers identical except when specifying Auxiliary switch and/or mixed poles, and have one rocker per breaker.
  - 3 All poles must be same polarity.
  - 4 3 pole units available only when 1 of 3 poles is neutral.
  - 5 On multi-pole breakers, one auxiliary switch is supplied, mounted in the extreme right pole.
  - 6 Screw Terminals are recommended on ratings greater than 20 amps.
  - 7 Terminal Code 1 (Push-On) available up to 30 amps, but are not recommended over 20 amps.
  - 8 Color shown is visi and legend with remainder of rocker black. Dual = ON-OFF/I-O legend.
  - 9 Legend on Push-to-reset bezel/shroud is white with single color actuator codes 7 & 8. Legend on Push-To-Reset bezel/shroud matches Visi-Color of rocker with actuator codes 5 & 6.
  - 10 Recessed "off-side" available with actuator codes 1, 2, 3 & 4. Legends on rocker are available in ink stamping only.
  - 11 Voltage rating available with 2 & 3-pole breakers only.
  - 12 Barriers supplied on multi-pole units only.

# Dimensional Specifications: in. [mm]

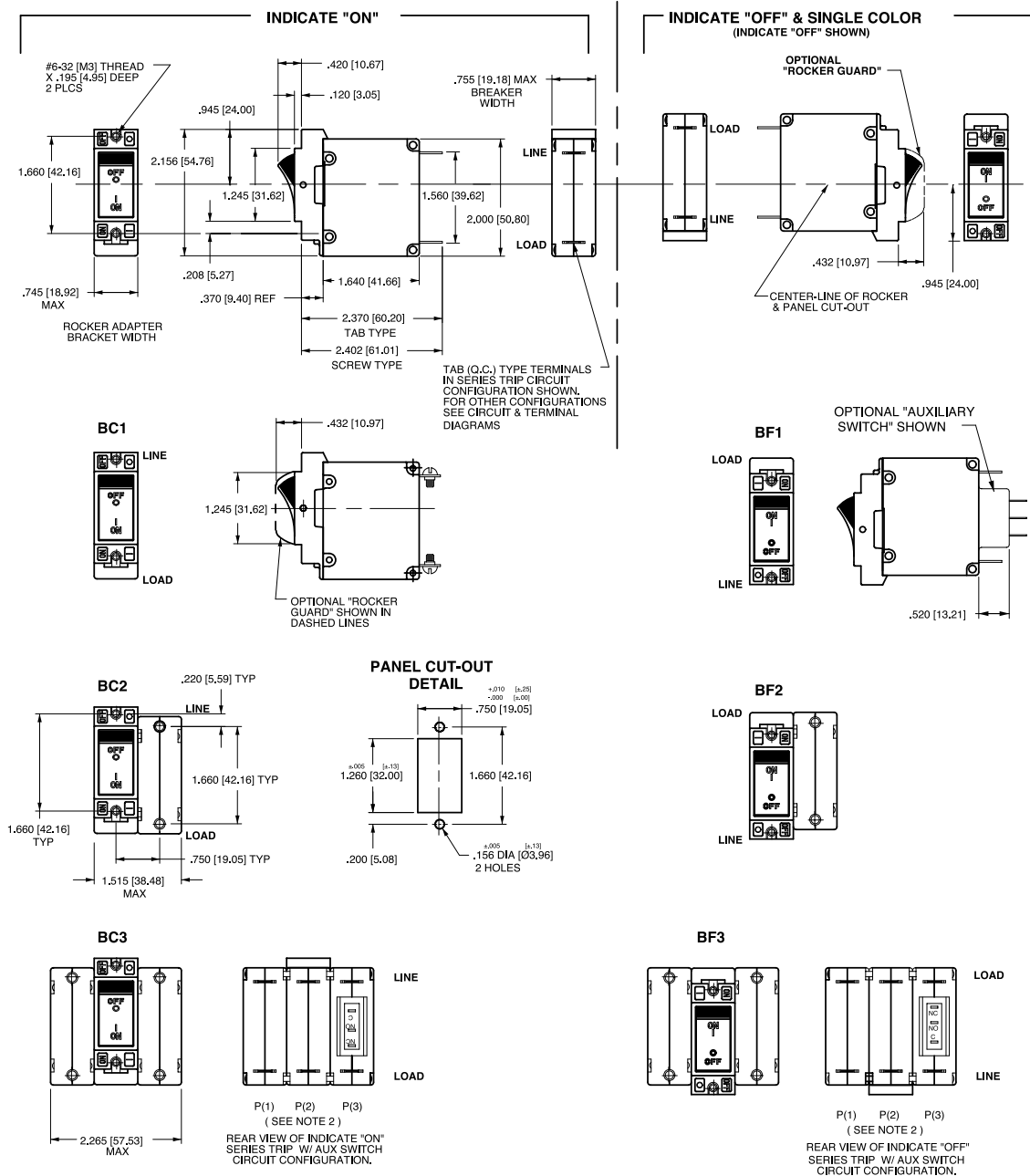

**Notes:**

- 1 Dimensions apply to all variations shown. Notice that circuit breaker line & load terminal orientation on indicate "OFF" is opposite of indicate "ON".
- 2 For pole orientation with horizontal legend, rotate front view clockwise 90°.
- 3 All dimensions are in inches [millimeters].
- 4 Tolerance  $\pm .020$  [51] unless otherwise specified.



# Dimensional Specifications: in. [mm]

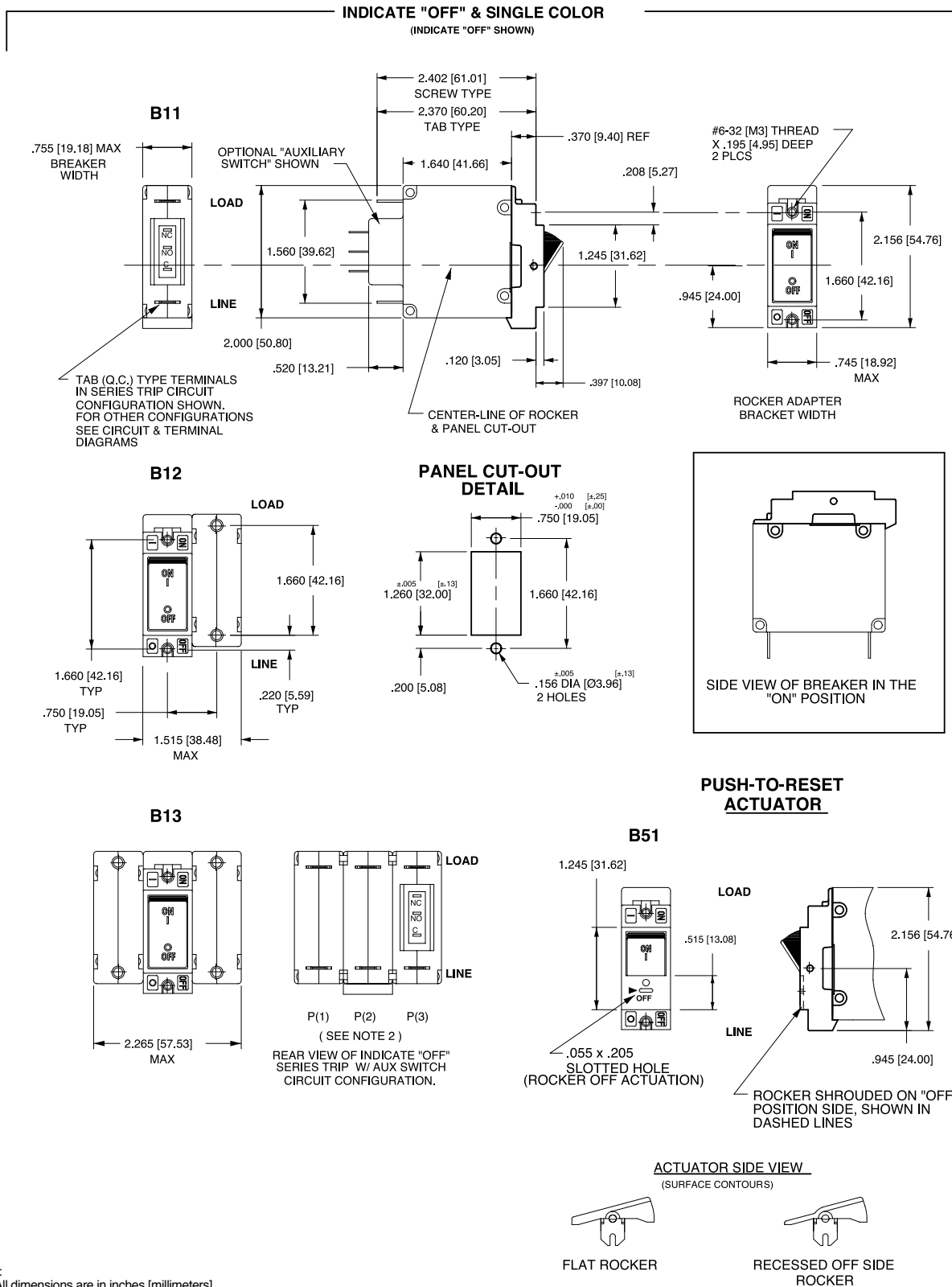

- Notes:
- 1 All dimensions are in inches [millimeters].
  - 2 For pole orientation with horizontal legend, rotate front view clockwise 90°.
  - 3 Tolerance ±.010 [.25] unless otherwise specified.

## PC Terminal Diagrams: in. [mm]

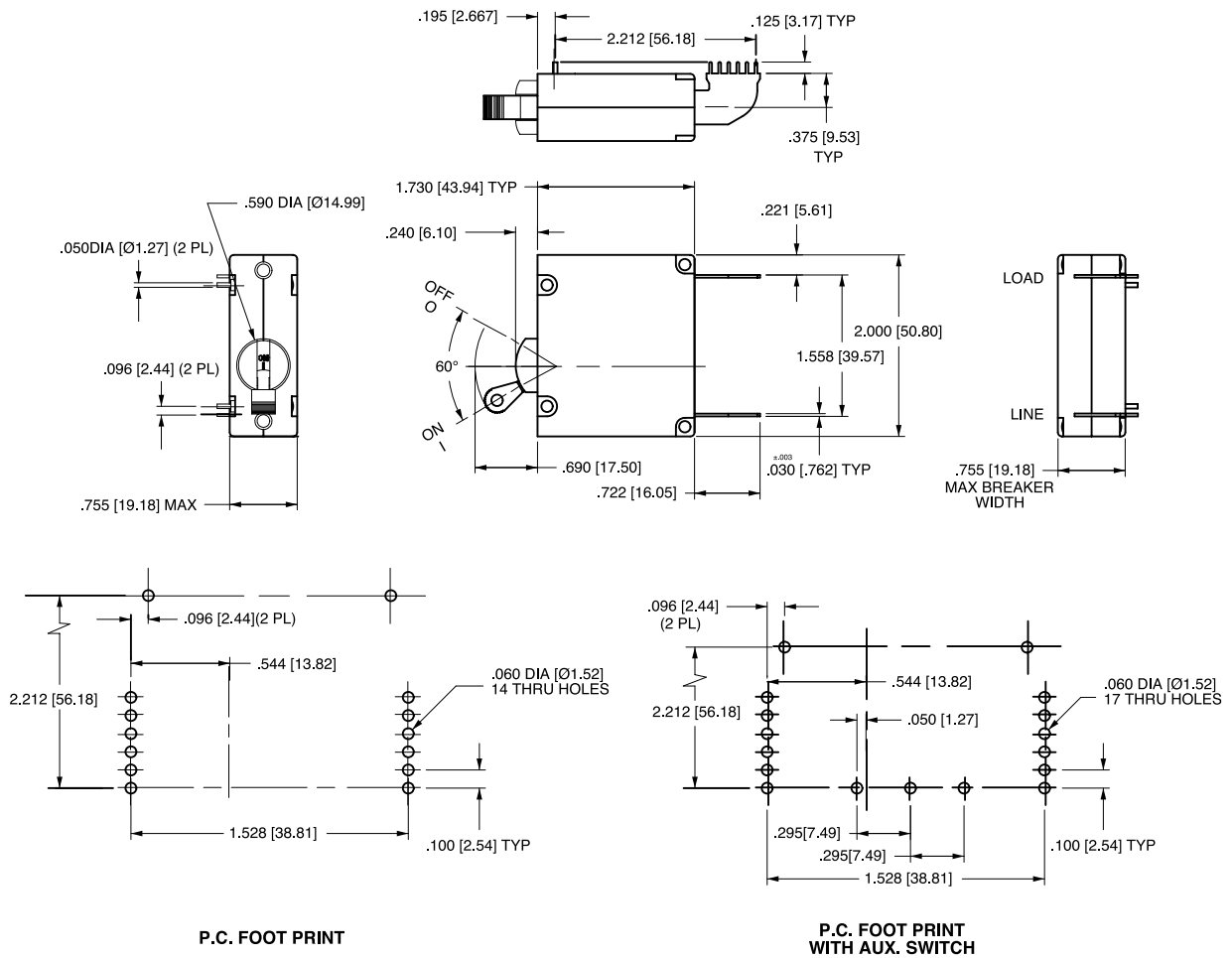

- Notes:
- 1 All dimensions are in inches [millimeters].
  - 2 For pole orientation with horizontal legend, rotate front view clockwise 90°.
  - 3 Tolerance  $\pm 0.10$  [25] unless otherwise specified.

# TB-Series

## TB-Series

### CIRCUIT BREAKER

The TB-Series is a space saving, tandem pole circuit breaker specifically designed to fit a two pole breaker into a one rack unit, making it ideal for datacom and PDU applications.

The TB-Series is designed with a common trip linkage ensuring if one pole trips, the tandem pole simultaneously trips. It also features a trip-free mechanism, a safety feature making it impossible to manually hold the contacts closed during overcurrent or fault conditions. TB-Series options include available handle guard to prevent inadvertent actuation and an auxiliary switch.

2 poles; ratings from 0.10 to 20 amps, 120/240VAC; UL 489 Listed, TUV, IEC/EN 60947-2.



#### Resources:

[Download 3D CAD Files](#)

[IGS >](#) [STP >](#)

[Watch Product Video](#)



#### Product Highlights:

- ♦ Fits in 1RU
- ♦ 2 Pole Protection in a 1 Pole Package
- ♦ Common Trip Included
- ♦ Optional Auxiliary Switch

#### Typical Applications:

- ♦ Datacom
- ♦ Power Distribution Units

## Electrical Tables

Table A: Voltage and Current Rating

TB SERIES TABLE A : UL489 LISTED, cUL and TUV CERTIFIED CIRCUIT BREAKERS						
Circuit Configuration	Voltage			Current Rating	Interrupting Capacity (Amps)	
	Max Rating	Frequency	Phase	Full Load Amps	UL / cUL	TUV
Series	120/240	50 / 60	1	0.10 - 20	10,000	5,000
	240 <sup>1</sup>	50 / 60	1	0.10 - 20	---	5,000

Notes:  
 1 Voltage rating requires wiring configuration according to TUV, see Dimensional Specifications drawings for wiring diagram.

### Electrical

Maximum Voltage	120/240VAC 50/60 Hz
Current Ratings	Standard current coils: 0.200, 0.350, 0.500, 0.750, 1.00, 2.50, 5.00, 7.50, 10.0, 15.0, 20.0 Amps. Other ratings available - consult ordering scheme.
Auxiliary/Alarm Switch Rating(s)	10.1A 250VAC 0.1A 80VDC
Dielectric Strength	Meets UL and CSA Requirements and can withstand 1500 VAC, 60Hz for one minute between all electrically isolated terminals. Breakers to hold 100%, and must trip at 125% of rated current and greater within the time limit shown on Table B. Data shown represents breaker response at ambient temperature of 77° F (25° C) with no preloading. Breakers are mounted vertically in standard wall-mount position.
Insulation Resistance	Minimum of 100 Megohms @ 500VDC
Overload	50 operations @ 600% rated current
Inrush Pulse Tolerance	Standard delays 12x rated current, high inrush delays 25x for 1/2 cycle @ 60 Hz
Resistance / Impedance	(Across circuit breaker terminals)

RESISTANCE, IMPEDANCE VALUES from Line to Load Terminals (Values Based on Series Trip Circuit Breaker)

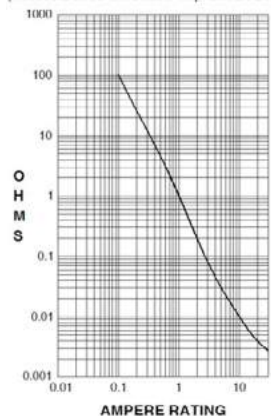

CURRENT (AMPS)	TOLERANCE (%)
0.10 - 5.0	± 15
5.1 - 20.0	± 25

### Agency Approvals

UL Listed (489) as Molded Case Circuit Breakers  
 TUV Certified IEC/EN 60947-2  
 CUL Certified CAN/CSA 22.2 No. 5

\*Manufacturer reserves the right to change product specification without prior notice.

### Mechanical

Endurance	6,000 ON-OFF operations @ 6 per minute; with rated Current and Voltage. 4,000 ON-OFF operations with no load.
Trip Free	All TB-Series Circuit Breakers will trip on overload, even when Handle is forcibly held in the ON position.
Trip Indication	The operating Actuator moves positively to the OFF position when an overload causes the breaker to trip.

### Physical

Internal Circuit Configurations	Series, with or without auxiliary / alarm switch
Weight	Approximately 170g/5.75oz per unit
Standard Colors	Housing – Black Actuator – White or Black with contrasting ON-OFF legends
Mounting	Refer to the dimensional specifications page

### Environmental

Designed and tested in accordance with requirements of specification MIL-PRF-55629 & MIL-STD-202 as follows:	
Shock	Withstands 100G's, 6ms sawtooth while carrying rated current per Method 213B, Test Condition "I". Instantaneous and ultra short curves tested @ 90% rated current.
Vibration	Withstands 0.060" excursion from 10-55Hz, and 10G's 55-500Hz, at rated current per Method 204D, Test Condition A. Instantaneous and ultrashort curves tested @ 90% of rated current.
Moisture Resistance/ Humidity	Method 106G, i.e. ten 24-hour cycles @ +25°C to +65°C, 80-98% RH
Salt Spray	Method 101E, Condition A (90-95% RH@ 5% NaCl Solution, 96 hours)
Thermal Shock	Method 107G, Condition A (Five cycles @ -55°C to +25°C to +85°C to 25°C)
Operating Temperature	-20° C to +85° C
Storage Temperature	-40° C to +85° C

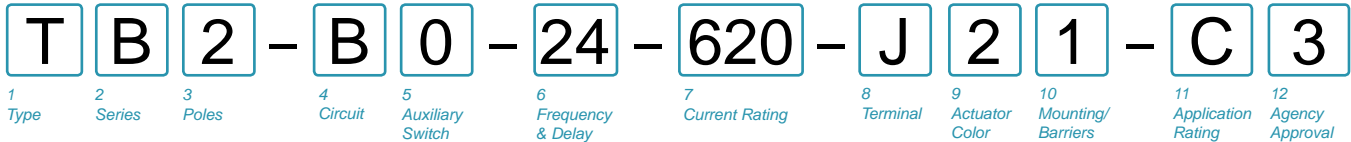

**1 TYPE**  
**T** Tandem Breaker

**2 SERIES**  
**B** B-Series Circuit Breaker

**3 POLES**  
**2** Two

**4 CIRCUIT**  
**B** Series Trip (Current)

**5 AUXILIARY SWITCH <sup>3</sup>**  
**0** without Aux Switch  
**1** S.P.D.T., 0.093 Q.C. Term.  
**2** S.P.D.T., 0.110 Q.C. Term.  
**3** S.P.D.T., 0.110 Solder Lug  
**8** S.P.S.T., 0.187 Q.C. Term.  
**9** S.P.D.T., 0.187 Q.C. Term.

**6 FREQUENCY & TIME DELAY**  
**21** 50/60Hz Ultra Short  
**22** 50/60Hz Short  
**24** 50/60Hz Medium  
**26** 50/60Hz Long  
**42** 50/60Hz Short, Hi-Inrush  
**44** 50/60Hz Medium, Hi-Inrush  
**46** 50/60Hz Long, Hi-Inrush

**7 CURRENT RATING (AMPERES)**

CODE	AMPERES	
<b>210</b>	0.10	<b>280</b> 0.80
<b>215</b>	0.15	<b>285</b> 0.85
<b>220</b>	0.20	<b>290</b> 0.90
<b>225</b>	0.25	<b>295</b> 0.95
<b>230</b>	0.30	<b>410</b> 1.00
<b>235</b>	0.35	<b>512</b> 1.25
<b>240</b>	0.40	<b>415</b> 1.50
<b>245</b>	0.45	<b>517</b> 1.75
<b>250</b>	0.50	<b>420</b> 2.00
<b>255</b>	0.55	<b>522</b> 2.25
<b>260</b>	0.60	<b>425</b> 2.50
<b>265</b>	0.65	<b>527</b> 2.75
<b>270</b>	0.70	<b>430</b> 3.00
<b>275</b>	0.75	<b>435</b> 3.50
		<b>440</b> 4.00
		<b>445</b> 4.50
		<b>450</b> 5.00
		<b>455</b> 5.50
		<b>460</b> 6.00
		<b>465</b> 6.50
		<b>470</b> 7.00
		<b>475</b> 7.50
		<b>480</b> 8.00
		<b>485</b> 8.50
		<b>490</b> 9.00
		<b>495</b> 9.50
		<b>610</b> 10.00
		<b>620</b> 20.00

**8 TERMINAL <sup>1</sup>**  
**J** Screw M5 Back Connect  
**K** Screw 10-32 Back Connect  
**N** Screw M4 Back Connect  
**Y** Screw 8-32 Back Connect

**9 ACTUATOR COLOR & LEGEND**

Actuator Color	ON-OFF	Dual	Legend Color
White	<b>B</b>	<b>1</b>	Black
Black	<b>D</b>	<b>2</b>	White
Red	<b>G</b>	<b>3</b>	White
Green	<b>J</b>	<b>4</b>	White
Blue	<b>L</b>	<b>5</b>	White
Yellow	<b>N</b>	<b>6</b>	Black
Gray	<b>Q</b>	<b>7</b>	Black
Orange	<b>S</b>	<b>8</b>	Black

**10 MOUNTING <sup>2</sup>**

	HORIZONTAL MOUNTING STYLE	BARRIER
<b>1</b>	6-32 x .195 in. Threaded Inserts	Offset
<b>3</b>	6-32 x .195 in. Threaded Inserts	Standard
<b>A</b>	6-32 x .195 in. Threaded Inserts with Actuator Guard	Offset
<b>C</b>	6-32 x .195 in. Threaded Inserts with Actuator Guard	Standard
<b>2</b>	ISO M3 x 5 mm Threaded Inserts	Offset
<b>4</b>	ISO M3 x 5 mm Threaded Inserts	Standard
<b>B</b>	ISO M3 x 5 mm Threaded Inserts with Actuator Guard	Offset
<b>D</b>	ISO M3 x 5 mm Threaded Inserts with Actuator Guard	Standard

	VERTICAL MOUNTING STYLE	BARRIER
<b>5</b>	6-32 x .195 in. Threaded Inserts	Offset
<b>7</b>	6-32 x .195 in. Threaded Inserts	Standard
<b>E</b>	6-32 x .195 in. Threaded Inserts with Actuator Guard	Offset
<b>G</b>	6-32 x .195 in. Threaded Inserts with Actuator Guard	Standard
<b>6</b>	ISO M3 x 5 mm Threaded Inserts	Offset
<b>8</b>	ISO M3 x 5 mm Threaded Inserts	Standard
<b>F</b>	ISO M3 x 5 mm Threaded Inserts with Actuator Guard	Offset
<b>H</b>	ISO M3 x 5 mm Threaded Inserts with Actuator Guard	Standard

**11 APPLICATION RATING**  
**C** 120/240 VAC

**12 AGENCY APPROVAL**  
**A** Without Approvals  
**G** UL489 Listed  
**3 4** UL489 Listed, TUV Certified

Notes:  
 1 Pole with auxiliary switch is supplied with 30 degree bus terminals.  
 2 Only available with terminal codes J,K,N,Y.  
 3 Supplied with one auxiliary switch. See dimensional specs drawings for location.  
 4 TUV certification only available with I/O ON/OFF markings (Actuator code: 1,2,3,4,5,6,7,8)

### Dimensional Specifications: in. [mm]

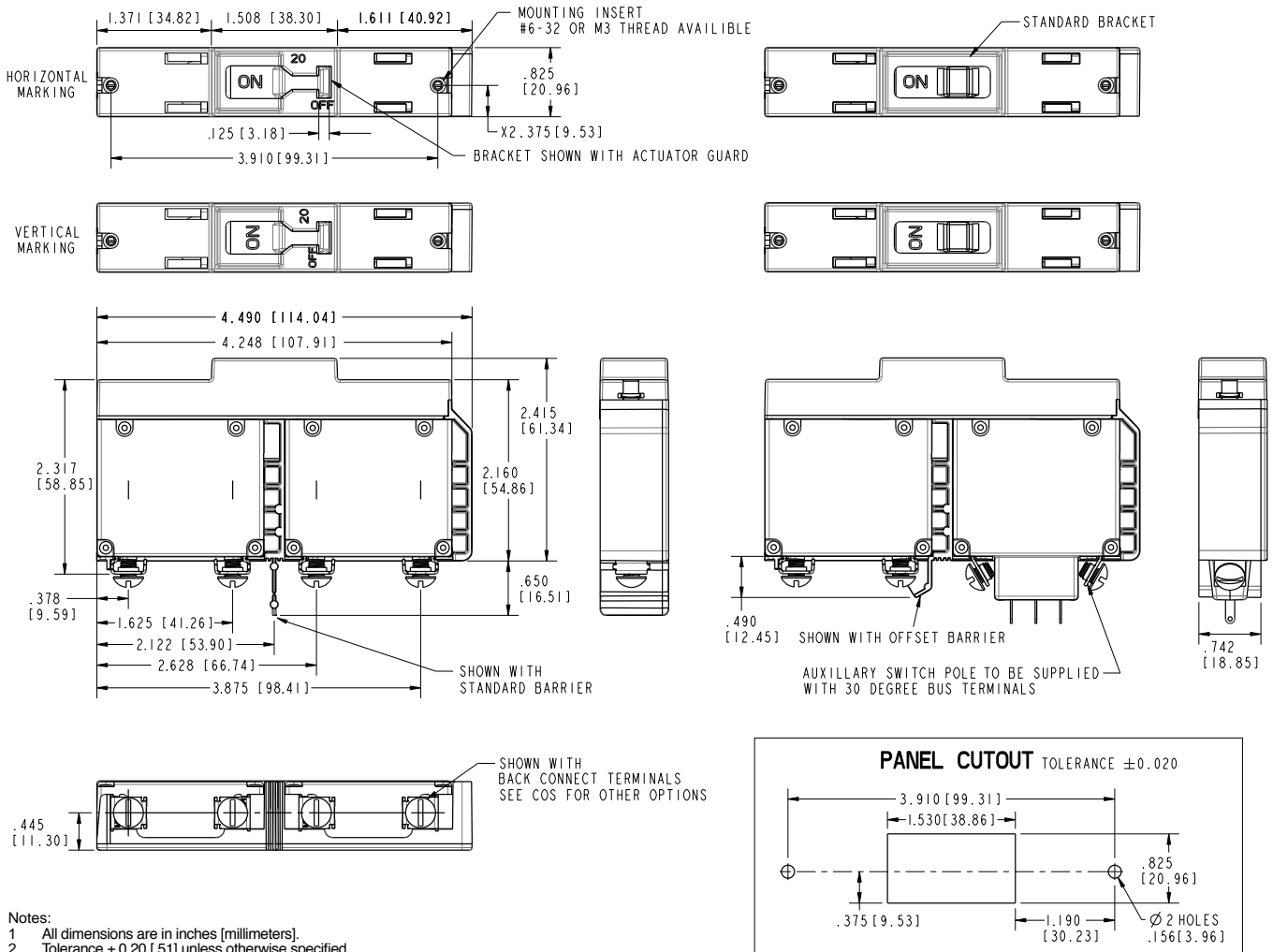

### Wiring Diagrams:

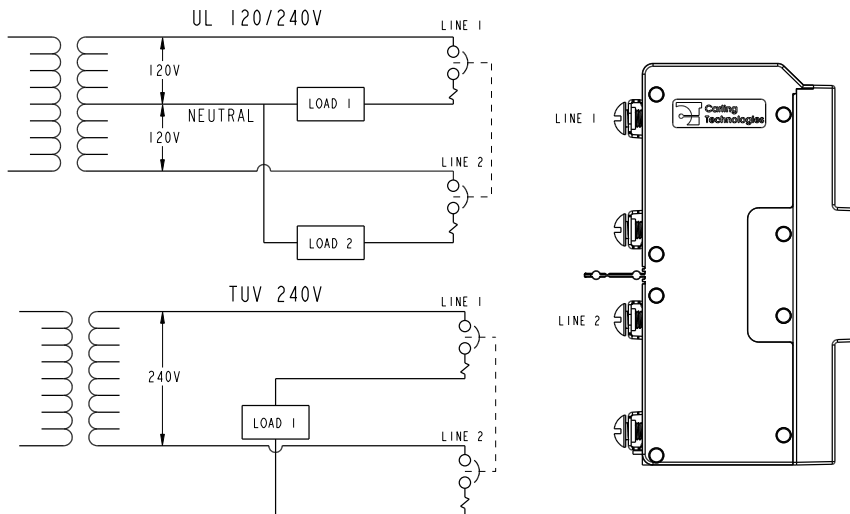

# C-Series

## CIRCUIT BREAKER

The C-Series hydraulic-magnetic circuit breakers are ideal for applications that require higher amperage and voltage handling capability in a smaller package. They are available in 1-6 poles, 0.02-100amps, UL Recognized up to 480VAC or 150VDC, UL489 Listed up to 240VAC or 125VDC, with choice of time delays, terminal options, actuator styles and colors. The C-Series employs a unique arc chute design which allows for higher interrupting capacities of up to 10,000 amps. Thermoset glass filled polyester half shell construction provides for increased mechanical and electrical strength. The wiping contacts mechanical linkage, with two step actuation, cleans contacts providing high, positive contact pressure and longer contact life. Available with American Standard or Metric Threaded Stud terminals, or Saddle Clamp screw terminals. The optional mid-trip handle style actuator allows a visual indication of electrical overload with or without alarm feature.



### Product Highlights:

- Extensive list of Agency Approvals
- Available with Standard or Metric Stud terminals, or Saddle Clamp screw terminals
- Optional mid-trip handle style actuator
- Unique arc chute design which allows for higher interrupting capacities of up to 10,000 amps
- Exclusive Rockerguard and Push-To-Reset bezel
- Available with new solid color and two-color Visi-rocker® actuators
- New thermoset glass filled polyester half shell construction

Only Telecom-Datacom applicable ordering schemes and drawings are shown in this catalog. For complete product details, please visit [www.carlingtech.com](http://www.carlingtech.com)

### Electrical

Maximum Voltage AC, 480 WYE/277 VAC, 50/60 Hz (see Table A.)  
 UL489: AC, 240 VAC. (See Table D), 50/60 Hz, 125 VDC

Current Rating Standard current coils: 0.100, 0.250, 0.500, 0.750, 1.00, 2.50, 5.00, 7.50, 10.0, 15.0, 25.0, 30.0, 35.0, 40.0, 50.0, 60.0, 70.0, 80.0, 90.0 and 100 amps. Other ratings available, see Ordering Scheme.

Standard Voltage Coils DC - 6V, 12V; AC - 120V; other ratings available, see Ordering Scheme.

Auxiliary Switch Rating SPDT; 10.1 amps-250VAC, DC Aux. Switch 1.0A, 65 VDC. 0.5A, 80VDC, 1/4 HP, 125VAC, VDE & TUV 1.0 125 VAC.

Insulation Resistance Minimum of 100 Megohms at 500 VDC.

Dielectric Strength UL, CSA: 1960 V 50/60 Hz for one minute between all electrically isolated terminals. C-Series Circuit Breakers comply with the 8mm spacing and 3750V 50/60 Hz dielectric requirements from hazardous voltage to operator accessible surfaces, between adjacent poles and from main circuits to auxiliary circuits per Publications EN 60950 and VDE 0805.

Resistance, Impedance Values from Line to Load Terminal - based on Series Trip Circuit Breaker.

RESISTANCE, IMPEDANCE VALUES from Line to Load Terminals (Values Based on Series Trip Circuit Breaker)

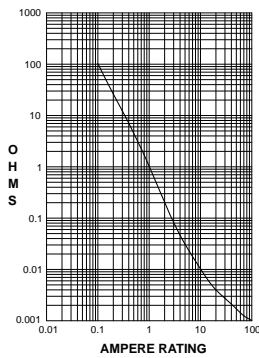

CURRENT (AMPS)	TOLERANCE (%)
0.10 - 5.0	15
5.1 - 20.0	25
20.1 - 50.0	35

### Pulse Tolerance Curves

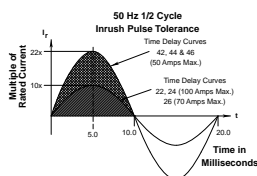
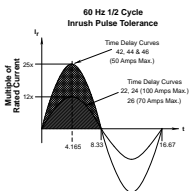

### Mechanical

Endurance 10,000 ON-OFF operations @ 6 per minute; with rated current & voltage.

Trip Free All C-Series circuit breakers will trip on overload, even when actuator is forcibly held in the ON position.

Trip Indication The operating actuator moves positively to the OFF position when an overload causes the breaker to trip. With mid-trip, handle moves to the mid position on electrical trip of the circuit breaker. With mid trip handle with alarm switch, handle moves to the mid position and the alarm switch actuates when the circuit breaker is electrically tripped.

### Physical

Number of Poles 1-6 poles ≤ 50A; 1-4 poles @ 51-70A; 1-2 poles 71-100A. UL489 Handle: 1 pole ≤ 100A, 2 pole ≤ 50A; Rocker: 1 pole ≤ 100A.

Internal Circuit Config. Series (with or without auxiliary switch, mid trip & mid trip with alarm switch) Shunt & Relay with current or voltage trip coils, Dual Coil, Switch Only (with or without aux. switch). UL489: Series (with or without auxiliary switch, mid-trip & midtrip with alarm switch).

Weight Approx. 112 grams/pole ( 3.95 oz).

Standard Colors Housing: Black

### Environmental

Designed and tested in accordance with requirements of specification MIL-PRF-55629 & MIL-STD-202 as follows:

Shock Withstands 100 Gs, 6ms sawtooth while carrying rated current per Method 213, Test Condition "I". Instantaneous and ultrashort curves tested @ 90% of rated current.

Vibration Withstands 0.060" excursion from 10-55 Hz & 10 Gs 55-500 Hz, @ rated current per Method 204C, Test Cond. A. Instantaneous & ultrashort curves tested @ 90% of rated current.

Moisture Resistance Method 106D, i.e., ten 24-hour cycles @ +25°C to +65°C, 80-98% RH.

Salt Spray Method 101, Condition A (90-95% RH @ 5% NaCl Solution, 96 hrs).

Thermal Shock Method 107D, Condition A (five cycles @ -55°C to +25°C to +85°C to +25°C).

Operating Temperature -40°C to +85°C

\*Manufacturer reserves the right to change product specification without prior notice.



Electrical Tables

Table A: Lists UL Recognized & CSA Accepted configurations and performance capabilities as a component supplementary protector

C-SERIES TABLE A: Component Supplementary Protectors												
Circuit Configuration	Voltage			Current Rating		Short Circuit Capacity (Amps)		Application Codes		Construction Notes		
	Max. Rating	Frequency	Phase	Full Load Amps	General Purpose Amps	UL / CSA		UL	CSA			
						With Backup Fuse	Without Backup Fuse					
Series	32	DC	---	0.02 - 100	---	---	5,000	TC1, OL1, U2	TC1, OL1, U2	---		
	48	DC	---	110 - 150	---	---	5,000			---		
	65	DC	---	0.02 - 70	---	71 - 100	---	5,000	TC1, 2, OL1, U1	TC1, 2, OL1, U1	---	
				-	---				TC1, 2, OL0, U1	TC1, 2, OL0, U1	---	
	80	DC	---	0.02 - 70	---	71 - 100	---	7,500	TC1, 2, OL1, U1	TC1, 2, OL1, U1	---	
				---	---				TC1, 2, OL0, U1	TC1, 2, OL0, U1	---	
				0.02 - 70	---				10,000	TC1, 2, OL1, U1	TC1, 2, OL1, U1	Must have Agency "L"
	---	71 - 100	TC1, 2, OL0, U1	TC1, 2, OL0, U1								
	125	DC	---	0.02 - 50	---	---	5,000	TC1, 2, OL1, U1	TC1, 2, OL1, U1	Must have Agency "L"		
	125/250	DC	---	0.02 - 50	---	---	5,000	TC1, 2, OL1, U1	TC1, 2, OL1, U1	Must have Agency "L"		
	250	DC	---	0.02 - 50	---	---	5,000	TC1, 2, OL1, U1	TC1, 2, OL1, U1	Must have Agency "L": 250 volts requires 2 pole		
	125	50 / 60	1	0.02 - 100	---	---	---	3,000	TC1, OL1, U2	TC1, OL1, U2	Per pole rating	
								5,000	TC1, 2, OL1, U1	TC1, 2, OL1, U1	Must have Agency "L"	
	150	DC	---	---	---	80 - 100	---	5,000	TC1, 2, OL0, U3	---	Must have Agency "L"	
												101 - 175
	125/250	50 / 60	1	0.02 - 100	---	---	---	3,500	TC1, OL1, U2	TC1, OL1, U2	---	
				0.02 - 50				---	3,000	TC1, 2, OL1, U1	TC1, 2, OL1, U1	2 or 3 poles breaking single phase
				51 - 100				---	1,000	TC1, 2, OL1, U1	TC1, 2, OL1, U1	2 or 3 poles breaking single phase
				0.02 - 100				---	5,000	TC1, 2, OL1, U2	TC1, 2, OL1, U2	2 or 3 poles breaking single phase. Agency "L"
	250	50 / 60	1	0.02 - 50	---	---	---	3,500	TC1, 2, OL1, U2	TC1, 2, OL1, U2	Per pole rating	
				0.02 - 100				---	5,000	TC1, 2, OL1, U1	TC1, 2, OL1, U1	Must have Agency "L"
				51 - 70				---	5,000	---	---	---
			3	---				0.02 - 100	---	3,000	TC1, 2, OL0, U2	TC1, 2, OL0, U2
---				0.02 - 70				---	5,000	---	---	3 poles breaking 3 phase
---	---	0.02 - 90	---	5,000	TC1, 2, OL0, U1	TC1, 2, OL0, U1	Must have Agency "L"					
277	50 / 60	1	0.02 - 50	---	---	5,000	---	---	---			
480/277	50 / 60	3	0.02 - 30	---	---	---	5,000	---	---	3 poles breaking 3 phase		
			---	---	---	---	---	---	---	---		
480	50 / 60	1	0.02 - 30	---	---	---	5,000	---	---	2 poles breaking 1 phase		
			---	---	---	---	---	---	---	---		
Dual Coil	80	DC	---	0.02 - 50	---	---	7,500	TC1, 2, OL1, U1	TC1, 2, OL1, U1	---		
	125	50 / 60	1	0.02 - 50	---	---	3,000	TC1, OL1, U2	TC1, OL1, U2	Per pole rating		
	125/250	50 / 60	1	0.02 - 50	---	---	---	3,500	TC1, OL1, U2	TC1, OL1, U2	2 or 3 poles breaking single phase	
								3,000	TC1, 2, OL1, U1	TC1, 2, OL1, U1	2 or 3 poles breaking single phase	
	250	50 / 60	1	0.02 - 50	---	---	---	3,500	TC1, OL1, U2	TC1, OL1, U2	---	
			3					---	3,000	TC1, OL0, U2	TC1, OL0, U2	Per pole rating
---	---	---	---	---	---	---	5,000	---	---	---		
277	50 / 60	1	0.02 - 50	---	---	---	5,000	---	---	3 poles breaking 3 phase		
Shunt	80	DC	---	0.02 - 50	---	---	7,500	TC1, 2, OL1, U1	TC1, 2, OL1, U1	---		
	277	50 / 60	1	0.02 - 50	---	---	5,000	---	---	---		
	250	50 / 60	3	0.02 - 50	---	---	---	5,000	---	---	3 poles breaking 3 phase	
								---	---	---	---	---
	480/277	50 / 60	3	0.02 - 30	---	---	---	5,000	---	---	3 poles breaking 3 phase	
---				31 - 50	---	---	---	---	---	---		
480	50 / 60	1	0.02 - 30	---	---	---	5,000	---	---	2 poles breaking 1 phase		
			---	31 - 50	---	---	---	---	---	---		
Relay	80	DC	---	0.02 - 50	---	---	7,500	TC1, 2, OL1, U1	TC1, 2, OL1, U1	---		
	277	50 / 60	1	0.02 - 50	---	---	5,000	---	---	---		
	250	50 / 60	3	0.02 - 50	---	---	5,000	---	---	3 poles breaking 3 phase		
Switch Only	65	DC	---	71 - 100	---	---	---	---	---	---		
				---	---	---	---	---	---			
	80	DC	---	71 - 100	---	---	---	---	---	---		
				---	---	---	---	---	---			
	125	50 / 60	1	0.02 - 100	---	---	---	---	---	---		
	125/250	50 / 60	1	0.02 - 100	---	---	---	---	---	---	2 or 3 poles breaking single phase	
---			---	---	---	---	---	---	---			
250	50 / 60	1	0.02 - 100	---	---	---	---	---	---	---		
		3	0.02 - 70	---	---	---	---	---	---	---		
277	50 / 60	1	0.02 - 50	---	---	---	---	---	---			
480/277	50 / 60	3	0.02 - 30	---	---	---	---	---	---	3 poles breaking 3 phase		
			---	31 - 50	---	---	---	---	---	---		

Notes:

- Requires branch circuit backup with a UL LISTED Type K5 or RK5 fuse rated 15A minimum and no more than 4 times full load amps not to exceed 125A for 50 Amp or less rating and not to exceed 175 for 51 through 100 Amp rating

Electrical Tables

Table B: Lists UL Recognized and CSA Accepted configurations and performance capabilities as a Manual Motor Controller.

C-SERIES TABLE B: Manual Motor Controllers					
Circuit Configuration	Voltage			Current Rating	Horsepower Ratings
	Max. Rating	Frequency	Phase	Full Load Amps	Max. HP
Series, Shunt & Relay Switch Only	120 <sup>1</sup>	50 / 60	1	0.02 - 50	7 1/2
	250 <sup>1</sup>	50 / 60	1	0.02 - 20	3
			3	0.02 - 20	5
	277 <sup>1</sup>	50 / 60	1	0.02 - 20	3
480 <sup>2</sup>	50 / 60	3	0.02 - 20	5	

- Notes:
- Requires branch circuit backup with a UL Listed Type K5 or RK5 fuse rated 15A Minimum and no more than 4 times full load amps not to exceed 125A for 50 Amp or less rating and not to exceed 175A for 51 through 100A rating.
  - UL Recognized and CSA Certified at 480V refers to 3 and 4 pole versions used in a 3Ø, WYE connected circuit or a 2 pole version with 2 poles breaking 1Ø and backed up with a series fusing as stated in note 1.
- \* Shunt and Relay Trip - Voltage Coil Construction not current coils

Table C: Lists UL Recognized, CSA Accepted, VDE and TUV Certified configurations and performance capabilities as a Component Supplementary Protector.

C-SERIES TABLE C: Component Supplementary Protectors															
Circuit Configuration	Voltage			Current Rating		Short Circuit Capacity (Amps)						Application Codes UL / CSA	Construction Notes		
	Max. Rating	Frequency	Phase	Full Load Amps	General Purpose Amps <sup>1</sup>	UL / CSA		VDE		TUV					
						With Backup Fuse	Without Backup Fuse	(Inc) With Backup Fuse	(Inc) Without Backup Fuse	(Inc) With Backup Fuse	(Inc) Without Backup Fuse				
Series	80	DC	---	0.10 - 70	---	---	7,500	---	5,000	5,000	1,500	TC1,2,OL1,U1	---		
				71 - 100	71 - 100	---	10,000	---	5,000	---	5,000	TC1,2,OL0,U1	Agency F, H, J or R		
	250	50 / 60	1	1 - 50	---	---	---	---	---	---	5,000	TC1,2,OL1,U1	Agency J or R		
				0.10 - 50	---	---	---	---	---	5,000	---	2P, Agency J or R			
				0.10 - 70	---	---	5,000	---	---	3,000	1,500	3,000	1,500	TC1,2,OL1,U1	---
				0.10 - 100	---	---	---	---	---	---	---	5,000	5,000	---	Agency J or R
415	50 / 60	3	0.10 - 30	---	---	5,000 <sup>2</sup>	---	3,000	1,500	3,000	1,500	TC1,2,OL1,C1	Rocker		
			0.10 - 90	---	---	---	---	5,000	2,500	3,000	1,500	---	Handle, Agency F, H, J or R		
Dual Coil	80	DC	---	0.10 - 30	---	---	7,500	---	1,500	5,000	1,500	TC1,2,OL1,U1	---		
	250	50 / 60	1 & 3	0.10 - 30	---	---	5,000	3,000	1,500	3,000	---	---	---		
Shunt	80	DC	---	0.10 - 70	---	---	7,500	---	5,000	5,000	1,500	TC1,2,OL1,U1	---		
	250	50 / 60	1 & 3	0.10 - 70	---	---	5,000	3,000	1,500	3,000	1,500	TC1,2,OL1,U1	---		
	415	50 / 60	3	0.10 - 30	---	---	5,000 <sup>2</sup>	---	3,000	1,500	3,000	1,500	TC1,2,OL1,C1	Rocker	
								5,000	2,500	---	---	---	Handle, Agency F, H, J or R		

- Notes:
- General Purpose ratings for UL/CSA only.
  - Requires branch circuit backup with a UL LISTED Type K5 or RK5 fuse rated 15A minimum and no more than 4 times full load amps not to exceed 125A for 50 Amp or less rating and not to exceed 175 for 51 through 100 Amp rating.

Table D: Lists UL Listed (489), CSA Certified (C22.2 No. 5.1-M) configuration and performance capabilities as a Molded Case Circuit Breaker.

C-SERIES TABLE D: UL489 Listed Branch Circuit Breakers							
Circuit Configuration	Voltage			Current Rating	Interrupting Capacity (Amps)		Construction Notes
	Max. Rating	Frequency	Phase	Full Load Amps	Without Backup Fuse		
Series	80	DC	---	0.10 - 100	50,000 <sup>1</sup>		Limited to 2 Poles Max from 71 - 100 Amps
					10,000		
				101 - 150	10,000		
	125	DC	---	0.10 - 100	5,000		1 - 3 Poles
				125 / 250	DC	---	0.10 - 50
	120	50 / 60	1	0.10 - 50	10,000		1 - 3 Poles
					5,000		
	120 / 240	50 / 60	1	0.10 - 50	5,000		2 or 3 Poles (1 pole of a 3 pole unit is neutral)
					10,000 <sup>1</sup>		
	240	50 / 60	1	0.10 - 30	5,000		1 Pole
				10,000		2 Poles	
277	50 / 60	1	0.10 - 20	10,000		1 Pole	
Dual Coil	120	50 / 60	1	0.10 - 30	10,000		---

- Notes:
- Special catalog number required. Consult factory.

### Electrical Tables

**Table E:** Lists UL Recognized, CSA Accepted configurations and performance capabilities as Protectors, Supplementary for Marine Electrical and Fuel Systems (Guide PEQZ2, File E75596). Ignition Protected per UL 1500. UL Classified Small Craft Electrical Devices, Marine in accordance with ISO 8846 (Guide UZMK, File MQ1515) as Marine Supplementary Protectors.

C-SERIES TABLE E: UL1500 (Marine Ignition Protection)								
Circuit Configuration	Voltage			Current Rating	Interrupting Capacity (Amps)	Application Codes		Construction Notes
	Max. Rating	Frequency	Phase	Full Load Amps	Without Backup Fuse	UL	CSA	
Series	48	DC	---	0.02 - 100	5,000	TC1, 2, OL1, U1	TC1, 2, OL1, U1	---
				101 - 150				
	65	DC	---	0.02 - 100	1,500	TC1, 2, OL0, U1	TC1, 2, OL0, U1	---
	80	DC	---	0.02 - 70	1,500	TC1, 2, OL1, U1	TC1, 2, OL1, U1	---
	125	50 / 60	1	0.02 - 70	5,000	TC1, 2, OL1, U1	TC1, 2, OL1, U1	---
				71 - 100	1,500			
	250	50 / 60	1	0.02 - 70	1,500	TC1, 2, OL1, U1	TC1, 2, OL1, U1	---
				71 - 100				

**Table F:** Lists UL Listed configurations and performance capabilities as Circuit Breakers for use in Communications Equipment (Guide DITT, File E189195), under UL489A.

C-SERIES TABLE F: PARALLEL POLE CONSTRUCTION UL489A Listed for Communications Equipment				
Circuit Configuration	Voltage		Current Rating	Interrupting Capacity (Amps)
	Max. Rating	Frequency	General Purpose Amps	Without Backup Fuse
Series	80	DC	100 - 250	10,000

### Agency Certifications

**UL Recognized**  
UL Standard 1077  

Component Recognition Program as Protectors Supplementary (Guide CCN/QVNU2, File E75596)

**CSA Accepted**  



Component Supplementary Protector under Class 3215 30, File 047848 0 000 CSA Standard C22.2 No. 235

UL Standard 508  

Switches, Industrial Control (Guide CCN/NRNT2, File E148683)

**CSA Certified**  



Circuit Breaker Model Case (Class 1432 01, File 093910), CSA Standard C22.2 No. 5.1 - M

UL Standard 1500  

Protectors, Supplementary for Marine Electrical & Fuel Systems (Guide PEQZ2, File E75596) Ignition Protection

**TUV Certified**  



EN60934, under License No. R72040875

**UL Listed**  
UL Standard 489  

Circuit Breakers, Molded Case, (Guide DIVQ, File E129899)

**VDE Certified**  

EN60934, VDE 0642 under File No. 10537

UL Standard 489A  

Communications Equipment (Guide CCN/DITT, File E189195)

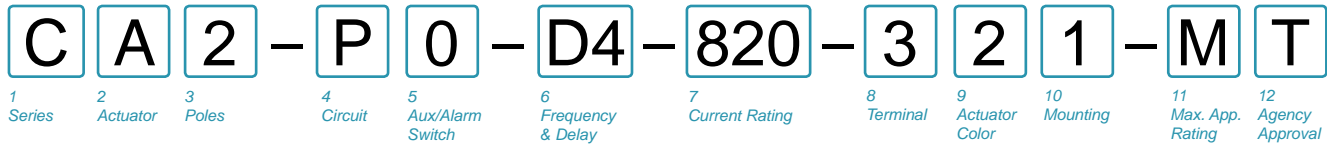

**1 SERIES**  
C

**2 ACTUATOR**  
A Handle, one per pole  
S Mid-Trip Handle, one per pole <sup>1</sup>  
T Mid-Trip, one per pole & Alarm Switch <sup>1</sup>

**3 POLES <sup>4</sup>**  
1 One  
2 Two  
3 Three

**4 CIRCUIT**  
P Series Trip (parallel pole)

**5 AUXILIARY / ALARM SWITCH**  
0 without Aux Switch  
2 S.P.D.T., 0.110 Q.C. Term.  
3 S.P.D.T., 0.139 Solder Lug  
4 S.P.D.T., 0.110 Q.C. Term. (Gold Contacts)  
5 S.P.S.T., N.O., 0.110 Q.C. Term. (Gold Contacts)  
6 S.P.S.T., 0.139 Solder Lug  
7 S.P.S.T., 0.110 Q.C. Term. (Gold Contacts)  
8 S.P.S.T., 0.187 Q.C. Term.  
9 S.P.D.T., 0.187 Q.C. Term.

**6 FREQUENCY & DELAY**  
D1 DC Ultra Short  
D2 DC Short  
D4 DC Medium  
D6 DC Long

**7 CURRENT RATING (AMPERES) <sup>4</sup>**

CODE	AMPERES				
810	100.00	813	130.00	817	170.00
811	110.00	814	140.00	817	175.00
812	120.00	815	150.00	818	180.00
812	125.00	816	160.00	819	190.00
				820	200.00
				922	225.00
				825	250.00

**8 TERMINAL <sup>5</sup>**  
3 1/4-20 threaded Stud  
6 M6 threaded Stud  
A Plug-In Stud <sup>3</sup>

**9 ACTUATOR COLOR <sup>2</sup>**

LEGEND	ON-OFF	Dual	Legend Color
White	B	1	Black
Black	D	2	White
Red	G	3	White
Green	J	4	White
Blue	L	5	White
Yellow	N	6	Black
Gray	Q	7	Black
Orange	S	8	Black

**10 MOUNTING**  
*Threaded Insert*  
1 6-32 x 0.195 inches  
2 ISO M3 x 5mm

**11 MAXIMUM APPLICATION RATING**  
M 80 DC

**12 AGENCY APPROVAL <sup>6</sup>**  
A Without Approval  
G UL489 Listed  
J UL489A Listed, TUV Certified  
K UL489A Listed, VDE Certified  
T UL489A Listed  
7 UL489A Listed, TUV Certified

- Notes:
- Handle moves to Mid-Position only upon electrical trip of C/B when Actuator S is specified. When Actuator Code T is specified, handle moves to Mid Position and Alarm Switch actuates only upon electrical trip of C/B. Code T is only available with Circuit Code N.
  - Standard Handle colors are White, Black, Red & Yellow.
  - Breakers with Terminal Codes 3 & 6 are supplied with bus bars connecting the Line and Load Terminals. For Terminal Code A, Line and Load Terminals must be connected to a copper bus bar having a minimum cross-section of 0.078 square inches. Terminal Code A is not available on the single pole unit.  
Ratings for 101 to 125 amps are available in 1-pole.  
Ratings from 110 to 200 amps are available in 2-pole.  
For ratings from 225-300 amps, specify 3-pole.
  - 1 pole only available with terminal codes 3 and 6.
  - Agency codes K and 7 are not available with 1 pole.  
Agency code J is only available with 1 pole.  
Agency code G is only available in 2 and 3 pole.
  - Circuit P, ratings 101-150 amps (2 pole) and ratings 151-250 amps (3 pole).

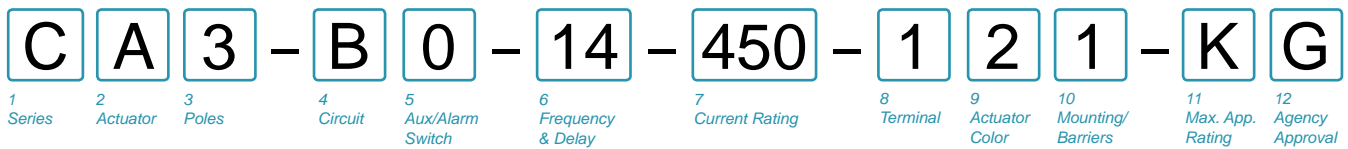

**1 SERIES**  
C

**2 ACTUATOR 1**  
A Handle, one per pole  
B Handle, one per multipole unit  
S Mid-Trip Handle, one per pole  
T Mid-Trip Handle, one per pole & Alarm Switch

**3 POLES 2**  
2 Two 3 Three

**4 CIRCUIT**  
B Series Trip (Current)

**5 AUXILIARY / ALARM SWITCH 3**  
0 without Aux Switch  
2 S.P.D.T., 0.110 Q.C. Term. 6 S.P.S.T., 0.139 Solder Lug  
3 S.P.D.T., 0.139 Solder Lug 8 S.P.S.T., 0.187 Q.C. Term.  
4 S.P.D.T., 0.110 Q.C. Term. 9 S.P.D.T., 0.187 Q.C. Term. (Gold Contacts)

**6 FREQUENCY & DELAY**  
11 DC Ultra Short 26 50/60Hz Long  
12 DC Short 42 4 50/60Hz Short, Hi-Inrush  
14 DC Medium 44 4 50/60Hz Medium, Hi-Inrush  
16 DC Long 46 4 50/60Hz Long, Hi-Inrush  
21 50/60Hz Ultra Short 52 4 DC Short, Hi-Inrush  
22 50/60Hz Short 54 4 DC Medium, Hi-Inrush  
24 50/60Hz Medium 56 4 DC Long, Hi-Inrush

**7 CURRENT RATING (AMPERES)**

CODE	AMPERES						
210	0.100	295	0.950	470	7.000	618	18.000
215	0.150	410	1.000	475	7.500	620	20.000
220	0.200	512	1.250	480	8.000	622	22.000
225	0.250	415	1.500	485	8.500	624	24.000
230	0.300	517	1.750	490	9.000	625	25.000
235	0.350	420	2.000	495	9.500	630	30.000
240	0.400	522	2.250	610	10.000	635	35.000
245	0.450	425	2.500	710	10.500	640	40.000
250	0.500	527	2.750	611	11.000	660	60.000
255	0.550	430	3.000	711	11.500	670	70.000
260	0.600	435	3.500	612	12.000	680	80.000
265	0.650	440	4.000	712	12.500	685	85.000
270	0.700	445	4.500	613	13.000	690	90.000
275	0.750	450	5.000	614	14.000	695	95.000
280	0.800	455	5.500	615	15.000	810	100.00
285	0.850	460	6.000	616	16.000		
290	0.900	465	6.500	617	17.000		

**8 TERMINAL 6**

1 7	Stud 10-32	6 9	Stud M6
2 8	Screw 10-32	9 9	7/16" Clip Terminal
3 9	Stud 1/4-20	A 10	Plug-In Stud
4 8	Stud M5 x 0.8	C 8	5/16" Clip Terminal
5 8	Screw M5 x 0.8		

**9 ACTUATOR COLOR & LEGEND 11**

Actuator Color	ON-OFF	Dual	Legend Color
White	B	1	Black
Black	D	2	White
Red	G	3	White
Green	J	4	White
Blue	L	5	White
Yellow	N	6	Black
Gray	Q	7	Black
Orange	S	8	Black

**10 MOUNTING / BARRIERS**

MOUNTING STYLE	BARRIERS 12
Threaded Insert	
1 6-32 x 0.195 inches	yes
2 ISO M3 x 5mm	yes

**11 MAXIMUM APPLICATION RATING**

A	65 DC
B	125 DC
C	120/240 AC 2
D	240 AC
K	120 AC
F	277 AC
M	80 DC

**12 AGENCY APPROVAL 11**

A	without approvals
F	UL489 Listed, CSA Certified & VDE Certified
G	UL489 Listed & CSA Certified
J	UL489 Listed, CSA Certified & TUV Certified

Notes:

- Actuator Code:  
A: Handle tie pin spacer(s) and retainers provided assembled with multi-pole units.  
B: Handle located, as viewed from front of breaker in left pole. 2 pole maximum.  
S: Handle moves to mid-position only upon electrical trip of the breaker.  
T: Handle moves to mid-position and alarm switch activates only upon electrical trip of the breaker.
- Standard multipole units have all poles identical except when specifying auxiliary switch and/or mixed poles.  
2 & 3 pole circuit breakers required for 120/240 VAC (Maximum application rating code C) applications, have all poles identical except when specifying auxiliary / alarm switch which is normally supplied in extreme right pole per figure B. Terminal barriers are required on all multipole breakers.  
Third pole is for 120/240 VAC applications requiring neutral disconnect. The 3rd pole has the same construction as poles 1 & 2.
- On multi-pole breakers, one auxiliary switch is supplied, mounted in the extreme right pole.  
VDE approval on auxiliary switch codes 2, 3 & 4 only.  
Auxiliary / Alarm Switch with Independent Circuit ie: separate from breaker circuit, only available with circuit breakers rated 50 amp maximum at 80 VDC, 125 VDC, and 120 VAC. Auxiliary / Alarm Switch with Dependent Circuit ie: same as circuit breaker, is supplied from factory with common terminal of auxiliary / alarm switch connected to line terminal on 120/240 and 240 VAC ratings. Circuit breakers rated 120 VAC 50 amp maximum can be supplied with Auxiliary/Alarm switch common terminal connected to breaker line terminal. Consult factory for special catalog number.
- Available up to 50 amps maximum.
- Current ratings 71 - 100 with VDE approvals are available up to two poles maximum.
- Terminal Codes 9 & C are not VDE approved.
- Terminal Code 1 available to 60 amps maximum.
- Terminal Codes 2, 4, 5 & C available to 50 amps maximum.
- Terminal Codes 3, 6 & 9 available to 100 amps maximum.
- Terminal Code A available to 100 amps maximum.
- VDE and TUV approvals require Dual (I-O, ON-OFF) markings on all handles.
- Barriers supplied on multi-pole units only.

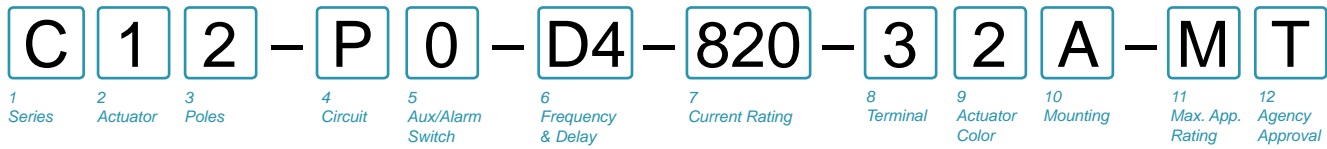

**1 SERIES**  
**C**

**2 ACTUATOR**  
**C** Curved Rocker, Two Color Visi, Indicate On, Vertical Legend  
**D** Curved Rocker, Two Color Visi, Indicate On, Horizontal Legend  
**F** Curved Rocker, Two Color Visi, Indicate Off, Vertical Legend  
**G** Curved Rocker, Two Color Visi, Indicate Off, Horizontal Legend  
**J** Curved Rocker, Single Color, Vertical Legend  
**K** Curved Rocker, Single Color, Horizontal Legend  
**N** Curved Rocker, Push To Reset, Two Color Visi, Vertical Legend  
**O** Curved Rocker, Push To Reset, Two Color Visi, Horizontal Legend  
**1** Flat Rocker, Two Color Visi, Vertical Legend  
**2** Flat Rocker, Two Color Visi, Horizontal Legend  
**3** Flat Rocker, Single Color, Vertical Legend  
**4** Flat Rocker, Single Color, Horizontal Legend  
**5** Flat Rocker, Push To Reset, Two Color Visi, Vertical Legend  
**6** Flat Rocker, Push To Reset, Two Color Visi, Horizontal Legend  
**7** Flat Rocker, Push To Reset, Single Color, Vertical Legend  
**8** Flat Rocker, Push To Reset, Single Color, Horizontal Legend

**3 POLES<sup>2</sup>**  
**1** One                                          **2** Two                                          **3** Three

**4 CIRCUIT**  
**P** Series Trip (parallel pole)

**5 AUXILIARY/ALARM SWITCH**  
**0** without Aux Switch  
**2** S.P.D.T., 0.110 Q.C. Term.  
**3** S.P.D.T., 0.139 Solder Lug  
**4** S.P.D.T., 0.110 Q.C. Term. (Gold Contacts)  
**5** S.P.S.T., N.O., 0.110 Q.C. Term. (Gold Contacts)  
**6** S.P.S.T., 0.139 Solder Lug  
**7** S.P.S.T., 0.110 Q.C.  
**8** S.P.S.T., 0.187 Q.C. Term.  
**9** S.P.D.T., 0.187 Q.C. Term.

**6 FREQUENCY & DELAY**  
**D1** DC Ultra Short  
**D2** DC Short  
**D4** DC Medium  
**D6** DC Long

**7 CURRENT RATING (AMPERES)<sup>2</sup>**

CODE	AMPERES				
<b>810</b>	100.00	<b>813</b>	130.00	<b>817</b>	170.00
<b>811</b>	110.00	<b>814</b>	140.00	<b>817</b>	175.00
<b>812</b>	120.00	<b>815</b>	150.00	<b>818</b>	180.00
<b>812</b>	120.00	<b>816</b>	160.00	<b>819</b>	190.00
<b>912</b>	125.00			<b>820</b>	200.00
				<b>922</b>	225.00
				<b>825</b>	250.00

**8 TERMINAL<sup>3</sup>**  
**3** Stud 1/4-20  
**6** Stud M6  
**A** Plug-In Stud<sup>1</sup>

**9 ACTUATOR COLOR**

LEGEND		Dual	Legend Color
ON-OFF			
White	<b>B</b>	<b>1</b>	Black
Black	<b>D</b>	<b>2</b>	White
Red	<b>G</b>	<b>3</b>	White
Green	<b>J</b>	<b>4</b>	White
Blue	<b>L</b>	<b>5</b>	White
Yellow	<b>N</b>	<b>6</b>	Black
Gray	<b>Q</b>	<b>7</b>	Black
Orange	<b>S</b>	<b>8</b>	Black

**10 MOUNTING**  
**ROCKER / MOUNTING INSERT STYLE**  
**A** Standard Rocker Bezel - 6-32 Inserts  
**B** Standard Rocker Bezel - M3 Inserts  
**C** Rocker Guard Bezel - 6-32 Inserts  
**D** Rocker Guard Bezel - M3 Inserts  
**E** Standard Bezel with recessed Off Side Flat Rocker - 6-32 Inserts  
**F** Standard Bezel with recessed Off Side Flat Rocker - M3 Inserts  
**G** Push to Reset Bezel - 6-32 Inserts  
**H** Push to Reset Bezel - M3 Inserts

**11 MAXIMUM APPLICATION RATING**  
**M** 80 DC

**12 AGENCY APPROVAL<sup>4</sup>**  
**A** Without Approval  
**G** UL489 Listed  
**J** UL489A Listed, TUV Certified  
**T** UL489A Listed  
**7** UL489A Listed, TUV Certified

- Notes:
- 1 Breakers with Terminal Codes 3 & 6 are supplied with bus bars connecting the Line and Load Terminals. For Terminal Code A, Line and Load Terminals must be connected to a copper bus bar having a minimum cross-section of 0.078 square inches. Terminal Code A is not available on the single pole unit.
  - 2 Ratings for 101 to 125 amps are available in 1-pole. Ratings from 110 to 200 amps are available in 2-pole. For ratings from 225-300 amps, specify 3-pole.
  - 3 1 pole only available with terminal codes 3 and 6.
  - 4 Agency codes K and 7 are not available with 1 pole. Agency code J is only available with 1 pole. Agency code G is only available in 2 and 3 pole. Circuit P, ratings 101-150 amps (2 pole) and ratings 151-250 amps (3 pole).

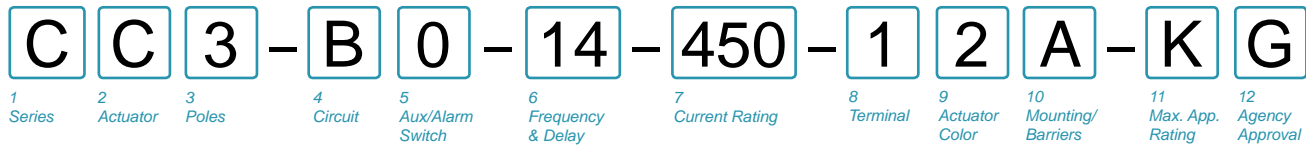

**1 SERIES**

**C**

**2 ACTUATOR 1**

**Two Color Visi-Rocker**

- C** Indicate ON, vertical legend
- D** Indicate ON, horizontal legend
- F** Indicate OFF, vertical legend
- G** Indicate OFF, horizontal legend

**Single color**

- J** Vertical legend
- K** Horizontal legend

**ROCKER STYLE DESCRIPTIONS**

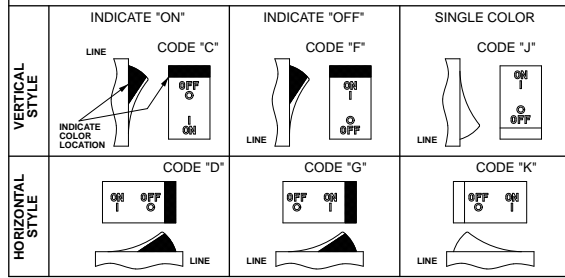

**3 POLES 1**

- 1** One
- 2** Two
- 3** Three

**4 CIRCUIT**

- B** Series Trip (current)

**5 AUXILIARY / ALARM SWITCH 2**

- 0** without Aux Switch
- 2** S.P.D.T., 0.110 Q.C. Term.
- 3** S.P.D.T., 0.139 Solder Lug
- 4** S.P.D.T., 0.110 Q.C. Term. (Gold Contacts)
- 6** S.P.S.T., 0.139 Solder Lug
- 8** S.P.S.T., 0.187 Q.C. Term.
- 9** S.P.D.T., 0.187 Q.C. Term.

**6 FREQUENCY & DELAY**

- 11** DC Ultra Short
- 12** DC Short
- 14** DC Medium
- 16** DC Long
- 21** 50/60Hz Ultra Short
- 22** 50/60Hz Short
- 24** 50/60Hz Medium
- 26** 50/60Hz Long
- 42**<sup>8</sup> 50/60Hz Short, Hi-Inrush
- 44**<sup>8</sup> 50/60Hz Medium, Hi-Inrush
- 46**<sup>8</sup> 50/60Hz Long, Hi-Inrush
- 52**<sup>8</sup> DC Short, Hi-Inrush
- 54**<sup>8</sup> DC Medium, Hi-Inrush
- 56** DC Long, Hi-Inrush

**Notes:**

- 1 Multi-pole breakers have all breakers identical except when specifying Auxiliary switch and/or mixed poles, and have one rocker per breaker.
- 2 On multi-pole breakers, one auxiliary switch is supplied, mounted in the extreme right pole.
- 3 Available up to 50 amps maximum.
- 4 Current ratings 71 - 100 with VDE approvals are available up to two poles maximum.
- 5 Terminal Code 1 available to 60 amps maximum.
- 6 Terminal Codes 2, 4, 5 & C available to 50 amps maximum.
- 7 Terminal Codes 3, 6, 9 & A available to 100 amps maximum.
- 8 Terminal Codes 9 & C are not VDE approved.
- 9 Color shown is visi and legend with remainder of rocker black
- 10 Dual = ON-OFF/I-O legend on actuator.
- 11 VDE and TUV approval requires Dual (I-O, ON-OFF) markings on rocker.
- 12 Rockerguard available with all actuator codes.
- 13 Barriers supplied on multi-pole units only.
- 14 2 & 3 pole circuit breakers required for 120/240 AC rating.

**7 CURRENT RATING (AMPERES) 4**

CODE	AMPERES	CODE	AMPERES	CODE	AMPERES	CODE	AMPERES
210	0.100	295	0.950	470	7.000	618	18.000
215	0.150	410	1.000	475	7.500	620	20.000
220	0.200	512	1.250	480	8.000	622	22.000
225	0.250	415	1.500	485	8.500	624	24.000
230	0.300	517	1.750	490	9.000	625	25.000
235	0.350	420	2.000	495	9.500	630	30.000
240	0.400	522	2.250	610	10.000	635	35.000
245	0.450	425	2.500	710	10.500	640	40.000
250	0.500	527	2.750	611	11.000	650	50.000
255	0.550	430	3.000	711	11.500	660	60.000
260	0.600	435	3.500	612	12.000	670	70.000
265	0.650	440	4.000	712	12.500	680	80.000
270	0.700	445	4.500	613	13.000	685	85.000
275	0.750	450	5.000	614	13.000	690	90.000
280	0.800	455	5.500	615	15.000	695	95.000
285	0.850	460	6.000	616	16.000	810	100.00
290	0.900	465	6.500	617	17.000		

**8 TERMINAL**

- 1<sup>5</sup> Stud 10-32
- 2<sup>6</sup> Screw 10-32 with saddle & washer clamps
- 3<sup>7</sup> Stud 1/4-20
- 4<sup>6</sup> Stud M5 x 0.8
- 5<sup>6</sup> Screw M5 x 0.8 with saddle & washer clamps
- 6<sup>7</sup> Stud M6
- 9<sup>7,8</sup> 7/16" Clip Terminal
- A<sup>7,8</sup> Plug-In Stud
- C<sup>6,8</sup> 5/16" Clip Terminal

**9 ACTUATOR COLOR & LEGEND 11**

Actuator or Visi-Color	Marking:	Marking Color:	Single Color	Rocker/Handle	Visi-Rocker
White	B	1	Black	Black	White
Black	D	2	White	White	n/a
Red	G	3	White	White	Red
Green	J	4	White	White	Green
Blue	L	5	White	White	Blue
Yellow	N	6	Black	Black	Yellow
Gray	Q	7	Black	Black	Gray
Orange	S	8	Black	Black	Orange

**10 MOUNTING / BARRIERS 12**

	Standard Rocker Bezel Threaded Insert, 2 per pole	Rockerguard Bezel Threaded Insert, 2 per pole	BARRIERS 13
A	6-32 X 0.195 inches	yes	
C	ISO M3 x 5mm	yes	
B	6-32 x 0.195 inches	yes	
D	ISO M3 x 5mm	yes	

**11 MAXIMUM APPLICATION RATING**

- A** 65 DC
- B** 125 DC
- C** 120/240 AC 14
- D** 240 AC
- F** 277 AC
- K** 120 AC
- M** 80 DC

**12 AGENCY APPROVAL**

- A** without approvals
- F** UL 489 Listed, CSA Certified, & VDE Certified
- G** UL 489 Listed & CSA Certified
- J** UL489 Listed, CSA Certified & TUV Certified

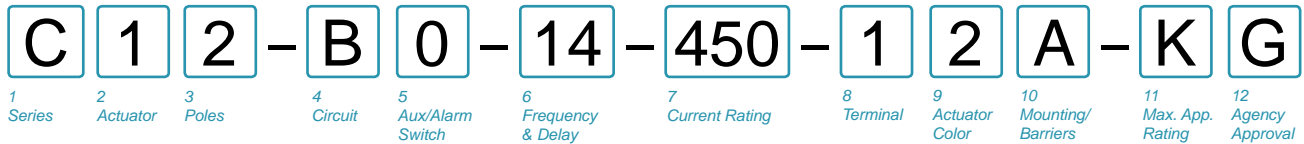

**1 SERIES**  
C

**2 ACTUATOR <sup>1</sup>**

**Two Color Visi-Rocker**

- 1 Indicate OFF, vertical legend
- 2 Indicate OFF, horizontal legend
- 3 Vertical legend
- 4 Horizontal legend

**Push-To-Reset, Visi-Rocker**

- 5 Indicate OFF, vertical legend
- 6 Indicate OFF, horizontal legend
- 7 Vertical legend
- 8 Horizontal legend

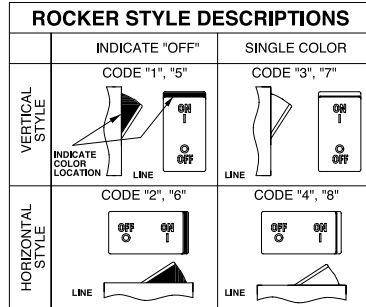

**3 POLES <sup>2</sup>**

- 1 One
- 2 Two
- 3 Three

**4 CIRCUIT**

- B Series Trip (current)

**5 AUXILIARY / ALARM SWITCH <sup>3</sup>**

- 0 without Aux Switch
- 2 S.P.D.T., 0.110 Q.C. Term.
- 3 S.P.D.T., 0.139 Solder Lug
- 4 S.P.D.T., 0.110 Q.C. Term. (Gold Contacts)
- 6 S.P.S.T., 0.139 Solder Lug
- 8 S.P.S.T., 0.187 Q.C. Term.
- 9 S.P.D.T., 0.187 Q.C. Term.

**6 FREQUENCY & DELAY**

- 11 DC Ultra Short
- 12 DC Short
- 14 DC Medium
- 16 DC Long
- 21 50/60Hz Ultra Short
- 22 50/60Hz Short
- 24 50/60Hz Medium
- 26 50/60Hz Long
- 42 <sup>4</sup> 50/60Hz Short, Hi-Inrush
- 44 <sup>4</sup> 50/60Hz Medium, Hi-Inrush
- 46 <sup>4</sup> 50/60Hz Long, Hi-Inrush
- 52 <sup>4</sup> DC Short, Hi-Inrush
- 54 <sup>4</sup> DC Medium, Hi-Inrush
- 56 <sup>4</sup> DC Long, Hi-Inrush

Notes:

- 1 Push-to-reset actuators have OFF portion of rocker shrouded.
- 2 Multi-pole breakers have all breakers identical except when specifying Auxiliary switch and/or mixed poles, and have one rocker per breaker.
- 3 On multi-pole breakers, one auxiliary switch is supplied, mounted in the extreme right pole.
- 4 Available up to 50 amps maximum.
- 5 Current ratings 71 - 100 with VDE approvals are available up to two poles maximum.
- 6 Terminal Code 1 available to 60 amps maximum.
- 7 Terminal Codes 2, 4, 5 & C available to 50 amps maximum.
- 8 Terminal Codes 3, 6, 9 & A available to 100 amps maximum.
- 9 Terminal Codes 9 & C are not VDE approved.
- 10 Color shown is visi and legend with remainder of rocker black
- 11 Dual = ON-OFF/I-O legend on actuator.
- 12 TUV approval requires Dual (I-O, ON-OFF) markings on rocker.
- 13 Legend on push-to-reset bezel/shroud is white when single color rocker is ordered. Legend on push-to-reset bezel/shroud matches visi-color of rocker with actuator codes 5 & 6.
- 14 Recessed "OFF-SIDE" available with actuator codes 1, 2, 3, & 4. Legends on rocker are available in ink stamping only.
- 15 Barriers supplied on multi-pole units only.
- 16 2 & 3 pole circuit breakers required for 120/240 AC rating.

**7 CURRENT RATING (AMPERES) <sup>5</sup>**

CODE	AMPERES	CODE	AMPERES	CODE	AMPERES	CODE	AMPERES
210	0.100	295	0.950	470	7.000	618	18.000
215	0.150	410	1.000	475	7.500	620	20.000
220	0.200	512	1.250	480	8.000	622	22.000
225	0.250	415	1.500	485	8.500	624	24.000
230	0.300	517	1.750	490	9.000	625	25.000
235	0.350	420	2.000	495	9.500	630	30.000
240	0.400	522	2.250	610	10.000	635	35.000
245	0.450	425	2.500	710	10.500	640	40.000
250	0.500	527	2.750	611	11.000	650	50.000
255	0.550	430	3.000	711	11.500	660	60.000
260	0.600	435	3.500	612	12.000	670	70.000
265	0.650	440	4.000	712	12.500	680	80.000
270	0.700	445	4.500	613	13.000	685	85.000
275	0.750	450	5.000	614	14.000	690	90.000
280	0.800	455	5.500	615	15.000	695	95.000
285	0.850	460	6.000	616	16.000	810	100.00
290	0.900	465	6.500	617	17.000		

**8 TERMINAL**

- 1 <sup>6</sup> Stud 10-32
- 2 <sup>7</sup> Screw 10-32
- 3 <sup>8</sup> Stud 1/4-20
- 4 <sup>7</sup> Stud M5 x 0.8
- 5 <sup>7</sup> Screw M5 x 0.8
- 6 <sup>8</sup> Stud M6
- 9 <sup>8,9</sup> 7/16" Clip Terminal
- A <sup>8</sup> Plug-In Stud
- C <sup>7,9</sup> 5/16" Clip Terminal

**9 ACTUATOR COLOR & LEGEND <sup>10</sup>**

Actuator or Visi-Color	Marking:	Marking Color:	Single Color	Visi-Rocker
Color:	ON-OFF	Dual <sup>11,12</sup>	Rocker/Handle	
White	B	1	Black	White
Black	D	2	White	n/a
Red	G	3	White	Red
Green	J	4	White	Green
Blue	L	5	White	Blue
Yellow	N	6	Black	Yellow
Gray	Q	7	Black	Gray
Orange	S	8	Black	Orange

**10 MOUNTING / BARRIERS**

	STANDARD ROCKER BEZEL	BARRIERS <sup>15</sup>
	Threaded Insert, 2 per pole	
A	6-32 X 0.195 inches	yes
C	ISO M3 x 5mm	yes
	RECESSED OFF ROCKER <sup>14</sup>	
	Threaded Insert, 2 per pole	
E	6-32 x 0.195 inches	yes
F	ISO M3 x 5mm	yes
	PUSH-TO-RESET BEZEL <sup>13</sup>	
	Threaded Insert, 2 per pole	
B	6-32 x 0.195 inches	yes
D	ISO M3 x 5mm	yes

**11 MAXIMUM APPLICATION RATING**

- A 65 DC
- B 125 DC
- C 120/240 AC <sup>16</sup>
- D 240 AC
- F 277 AC
- K 120 AC
- M 80 DC

**12 AGENCY APPROVAL <sup>12</sup>**

- A without approvals
- G UL 489 Listed & CSA Certified
- J UL489 Listed, CSA Certified & TUV Certified



## Circuit & Terminal Diagrams: in. [mm]

TERMINAL			RATING (AMPS)		
DESCRIPTION	CODE	DIMENSIONAL DETAIL	25	50	100
#10-32 STUD	1				
M5 STUD	4				
#1/4-20 STUD	3				
M6 STUD	6				
#1/4-20 STUD	3				
M6 STUD	6				
#10-32 SCREW	2				
M-5 SCREW	5				

TERMINAL			RATING (AMPS)		
DESCRIPTION	CODE	DIMENSIONAL DETAIL	25	50	100
.250 DOUBLE Q.C.	7				
7/16" CLIP TERMINALS	9				
PUSH-IN STUD	A				

NOTES: TOLERANCE ON STUD LENGTHS IS  $\pm .031$  [ $\pm .79$ ] UNLESS OTHERWISE SPECIFIED.

### AUXILIARY / ALARM SWITCH TERMINAL DETAIL<sup>3</sup>

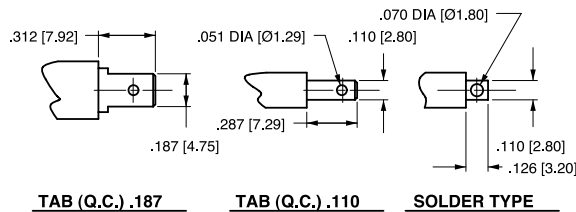

TIGHTENING TORQUE SPECIFICATIONS	
THREAD SIZE	TORQUE
#6-32 [M3] MOUNTING INSERTS	7-9 IN-LBS [0.8-1.0 NM]
#10-32 & M5 THD STUDS	15-20 IN-LBS [1.7-2.3 NM]
#10-32 THD SCREW	15-20 IN-LBS [1.7-2.3 NM]
#1/4-20 & M6 THD STUDS	30-35 IN-LBS [3.4-4.0 NM]

TERMINAL HARDWARE				
TERMINAL DESCRIPTION	CODE	AGENCY APPROVAL	AMPERE RATING	HARDWARE SUPPLIED
#10-32 STUD	1	ALL	.02 - 50	LOCK WASHER - FLAT WASHER - NUT
M5 STUD	4	ALL	.02 - 50	LOCK WASHER - FLAT WASHER - NUT
#1/4-20 STUD	3	ALL	.02 - 80	LOCK WASHER - FLAT WASHER - NUT
			81 - 100	LOCK WASHER - NUT - (2)FLAT WASHER - NUT
M6 STUD	6	ALL	.02 - 80	LOCK WASHER - FLAT WASHER - NUT
			81 - 100	LOCK WASHER - NUT - (2)FLAT WASHER - NUT
#10-32 SCREW	2 & 5	UL RECOGNIZED	.02 - 50	* SADDLE CLAMP - FLAT WASHER - SCREW
		UL-489 LISTED	.02 - 50	LOCK WASHER - FLAT WASHER - SCREW
		TUV & VDE CERTIFIED	.02 - 16	* SADDLE CLAMP - FLAT WASHER - SCREW
		TUV & VDE CERTIFIED	16.1 - 50	LOCK WASHER - FLAT WASHER - SCREW

\* THE SADDLE CLAMP IS FOR DIRECT WIRE CONNECTION USE. DISCARD SADDLE CLAMP IF WIRE TERMINAL LUG IS USED

Notes:

- All dimensions are in inches [millimeters].
- Tolerance  $\pm .020$  [.51] unless otherwise specified.
- Available on Series Trip and Switch Only Circuits when called for on multi-pole units. Only one auxiliary switch is normally supplied, as viewed in multi-pole identification scheme.

## Circuit & Terminal Diagrams: in. [mm]

	CIRCUIT SCHEMATIC		CIRCUIT CODE	AUX SWITCH CODE	CIRCUIT SCHEMATIC		CIRCUIT CODE	AUX SWITCH CODE
	ANSI	IEC			ANSI	IEC		
	SWITCH ONLY (NO COIL)							
			A	O			B	O
	SWITCH ONLY (NO COIL) WITH AUXILIARY SWITCH		A	2 3 4	SERIES TRIP WITH AUXILIARY / ALARM SWITCH		B	C 3 4
	SHUNT TRIP		D E	0	DUAL COIL; SERIES TRIP CURRENT COIL, SHUNT TRIP VOLTAGE COIL		H	0
	RELAY TRIP		F G	0	DUAL COIL; SERIES TRIP CURRENT COIL, RELAY TRIP VOLTAGE COIL		K	0

HANDLE POSITION VS. AUX/ALARM SWITCH MODE					
CIRCUIT BREAKER MODE	STANDARD C/B		MID TRIP C/B		
	HANDLE POSITION	AUX. SWITCH MODE	HANDLE POSITION	STANDARD ALARM SWITCH MODE	REVERSE ALARM SWITCH MODE <sup>4</sup>
OFF					
ON					
ELECTRICAL TRIP					

- Notes:
- All dimensions are in inches [millimeters].
  - Tolerance  $\pm .020$  [.51] unless otherwise specified.
  - Schematic shown represents current trip circuits.
  - Available only as special catalog number.

## Dimensional Specifications: in. [mm]

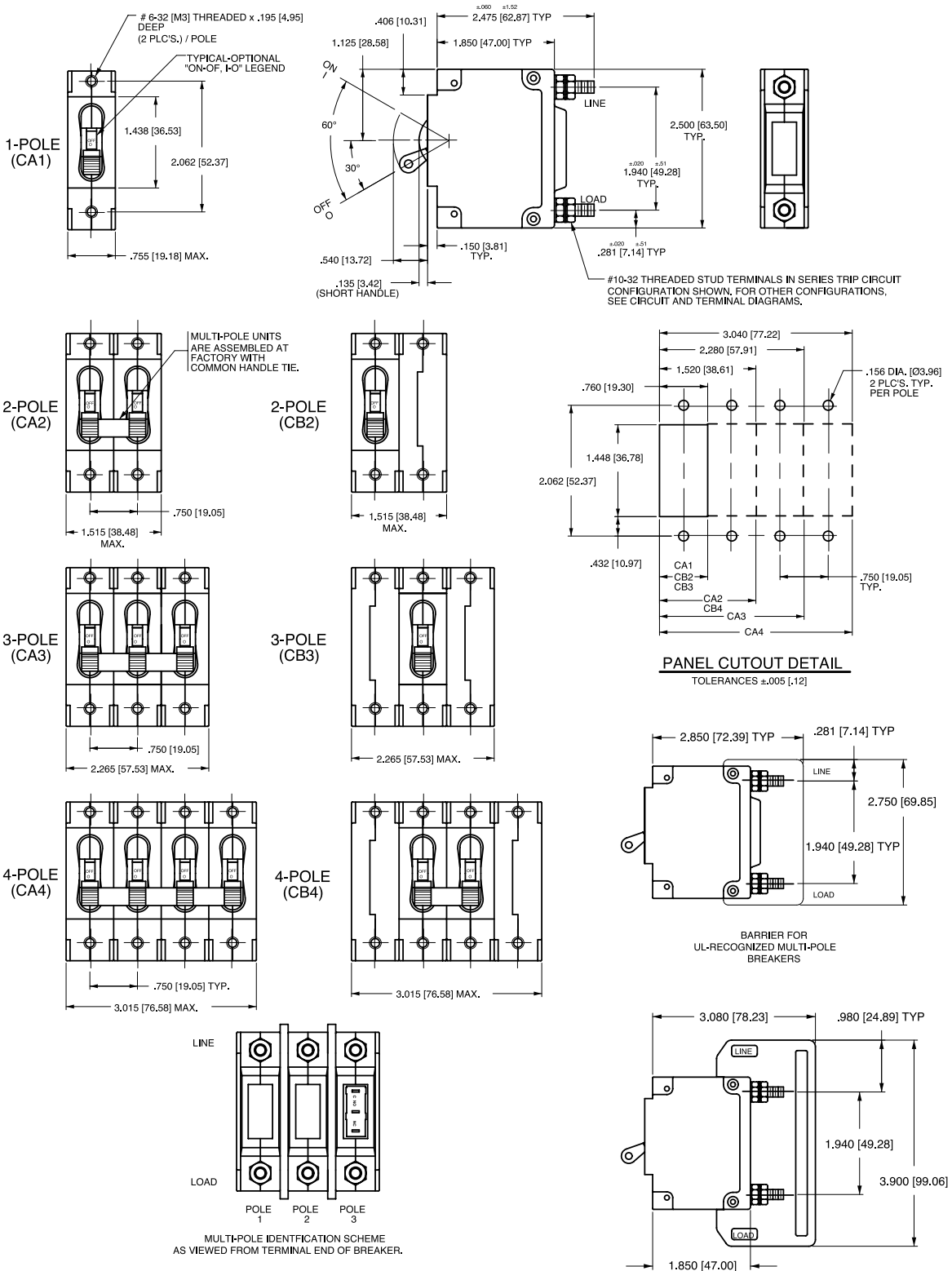

- Notes:
- All dimensions are in inches [millimeters].
  - Tolerance ±.020 [0.51] unless otherwise specified.

## Dimensional Specifications: in. [mm]

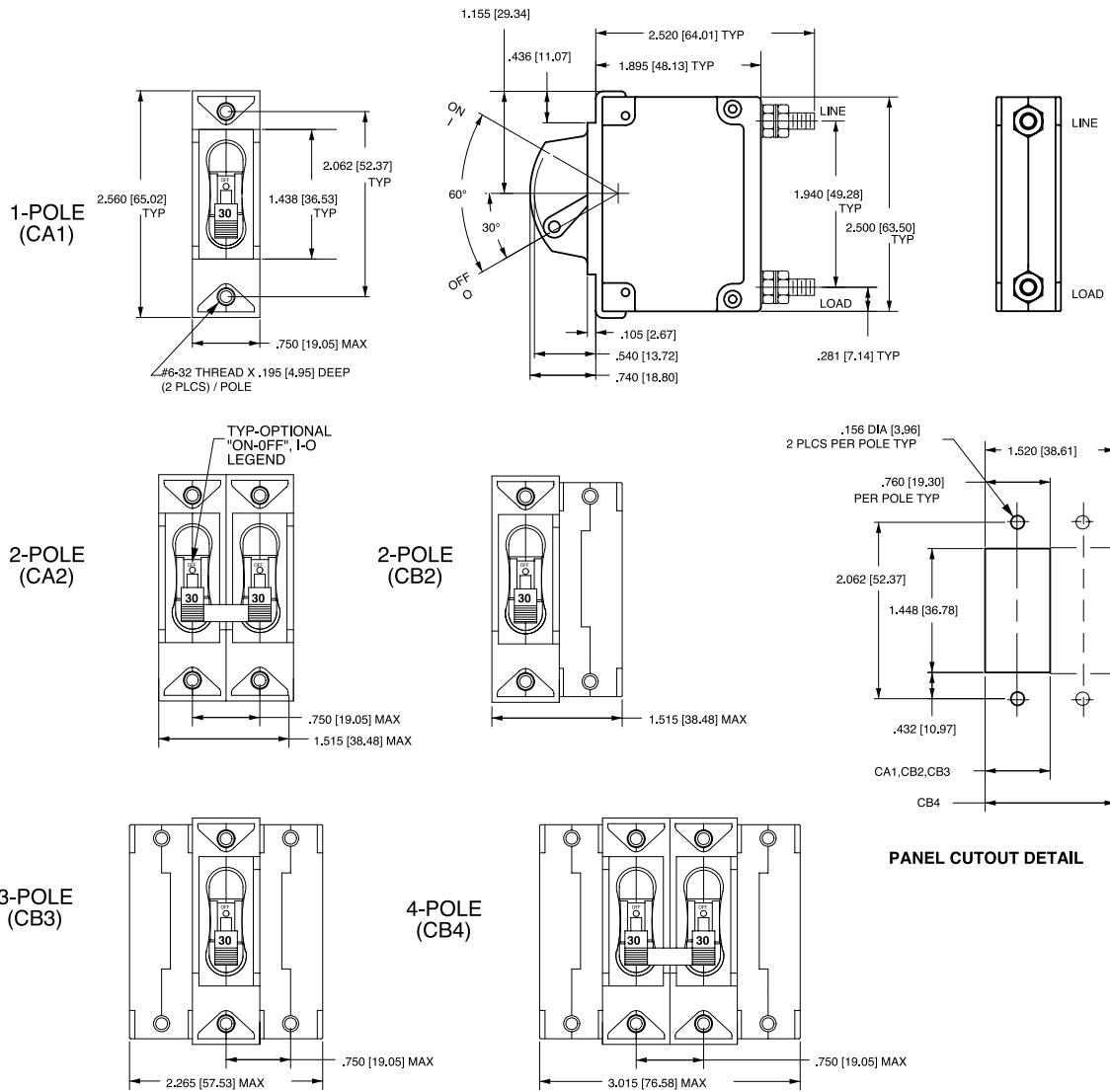

\*Handguard available as special catalog number only

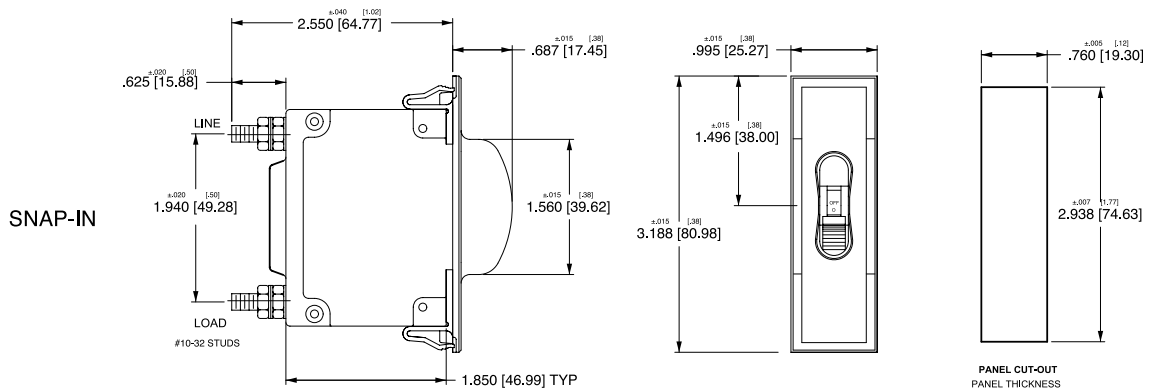

**Notes:**

- 1 All dimensions are in inches [millimeters].
- 2 Tolerance  $\pm 0.020$  [.51] unless otherwise specified.

## Dimensional Specifications: in. [mm]

1-POLE (CA1)  
w/ ARC CHUTE BARRIER

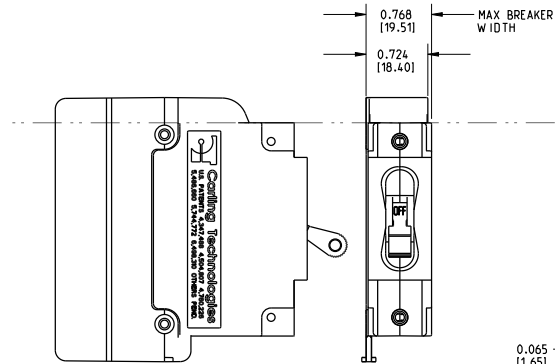

3-POLE (CA3)  
w/ ARC CHUTE BARRIER

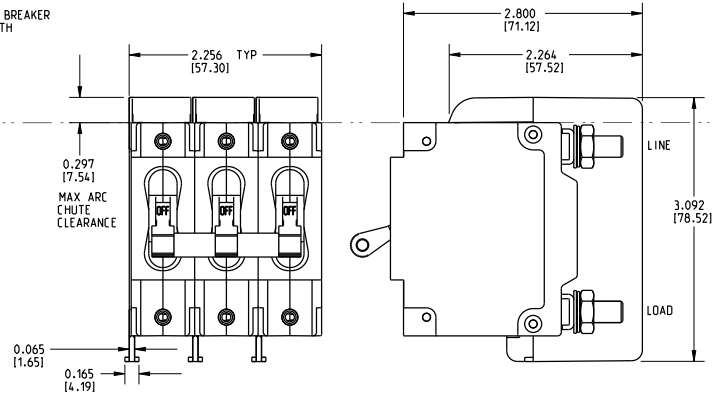

INDICATE "ON"

1-POLE (CC1, CD1)  
w/ ARC CHUTE (NO BARRIER)

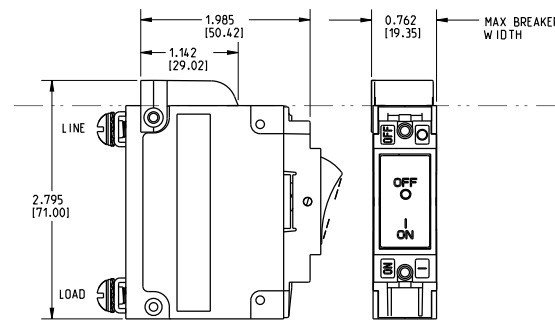

3-POLE (CC3, CD3)  
w/ ARC CHUTE BARRIER

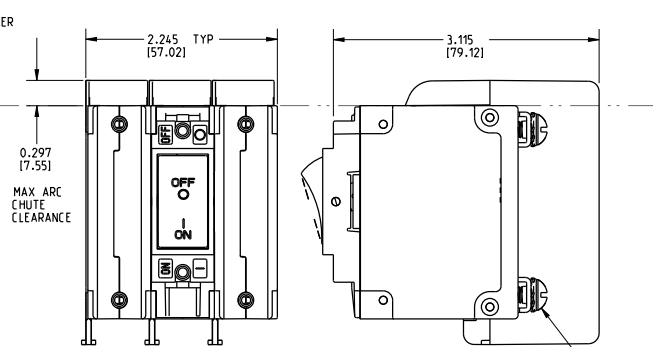

SCREW TYPE TERMINALS IN SERIES TRIP CIRCUIT CONFIGURATION SHOWN.

INDICATE "OFF" / SINGLE COLOR

1-POLE (CF1, CG1, C11, C21)  
w/ ARC CHUTE (NO BARRIER)

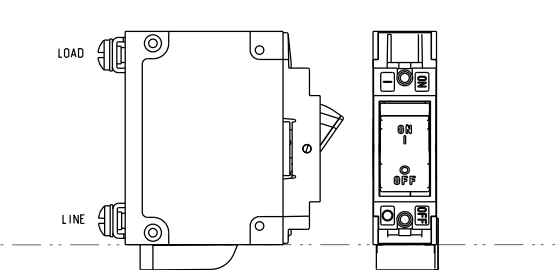

3-POLE (CF3, CG3, C13, C23)  
w/ ARC CHUTE BARRIER

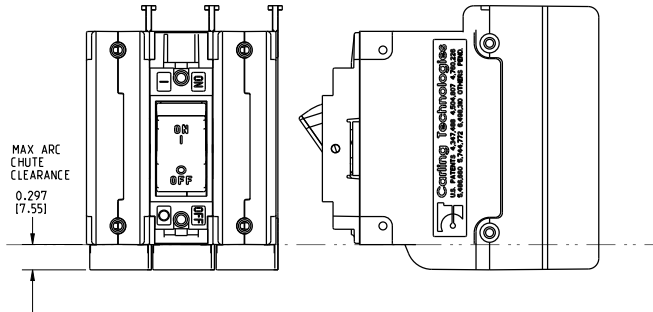

Notes:

- 1 Only 1-pole and 3-pole configurations shown. Arc chute (without barrier) and arc chute barrier also available for 2-pole construction.
- 2 Dimensions apply to all variations shown.
- 3 Notice that line and load terminal orientation for indicate on and indicate off rocker circuit breakers are opposite.
- 4 Screw type terminals shown for Rocker style (CF1, C11, etc) circuit breakers. For other terminal configurations see circuit and terminal diagrams.
- 5 All dimensions are in inches [millimeters].
- 6 Tolerance  $\pm .020$  unless otherwise specified.
- 7 Must be ordered under a special catalog number.

# Dimensional Specifications: in. [mm]

## PARALLEL POLE (CA2-P)

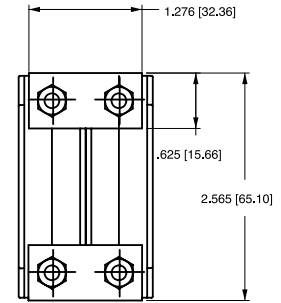
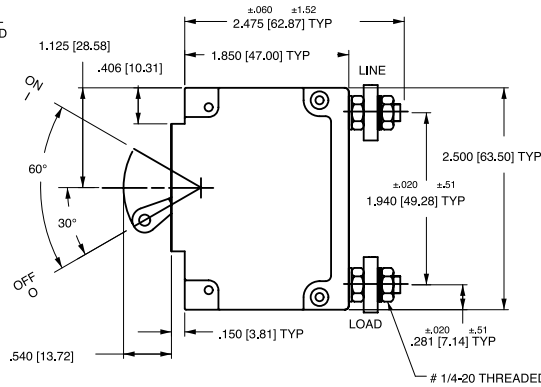
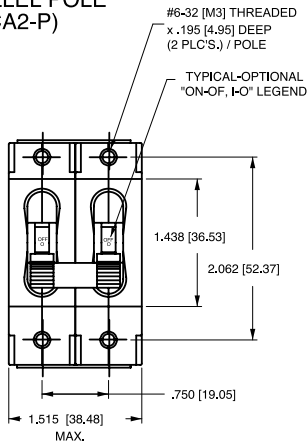

## PARALLEL POLE (CA3-P)

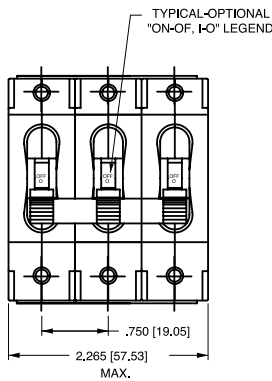

CIRCUIT BREAKER PROFILE	CIRCUIT SCHEMATIC (CA2-P SHOWN)		CIRCUIT CODE	AUX SWITCH CODE
	ANSI	IEC		
	<b>SERIES TRIP</b> 		P	0
	<b>SERIES TRIP WITH AUXILIARY SWITCH</b> 		P	2 3 4

## TERMINAL DETAILS

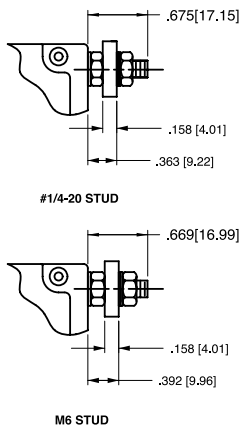
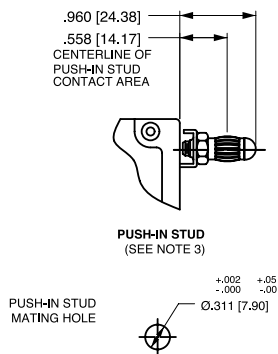

## PANEL CUTOUT DETAIL

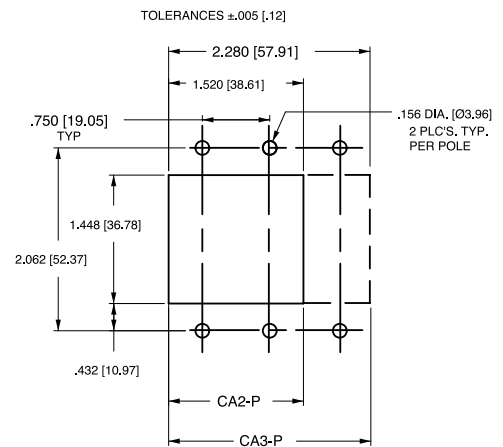

- Notes:
- All dimensions are in inches [millimeters].
  - Tolerance  $\pm 0.020$  [.51] unless otherwise specified.

## Dimensional Specifications: in. [mm]

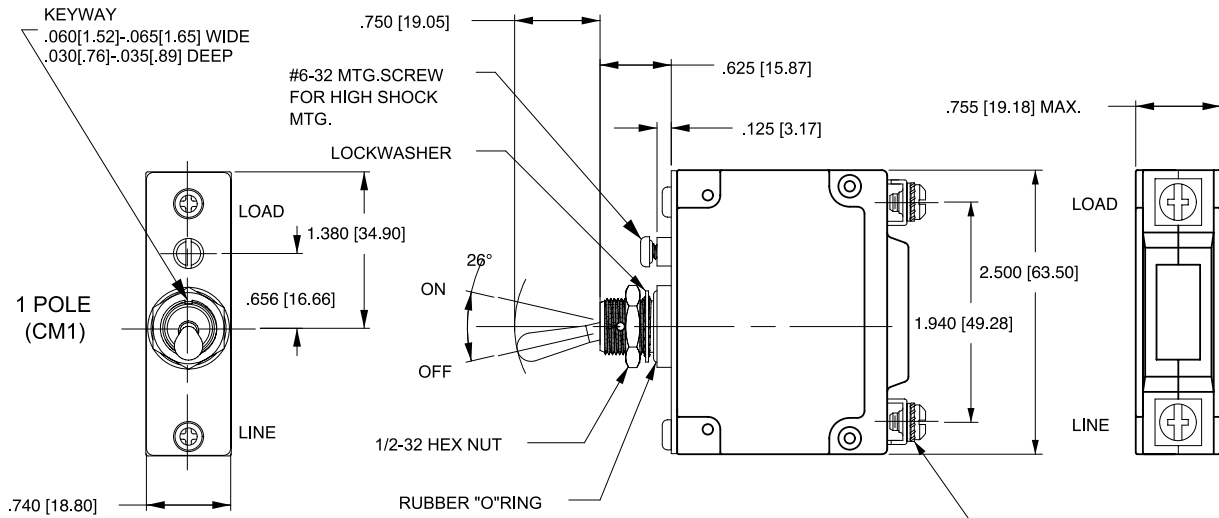

SCREW TYPE TERMINALS IN SERIES TRIP CIRCUIT CONFIGURATION SHOWN. FOR OTHER CONFIGURATIONS SEE CIRCUIT & TERMINAL DIAGRAMS

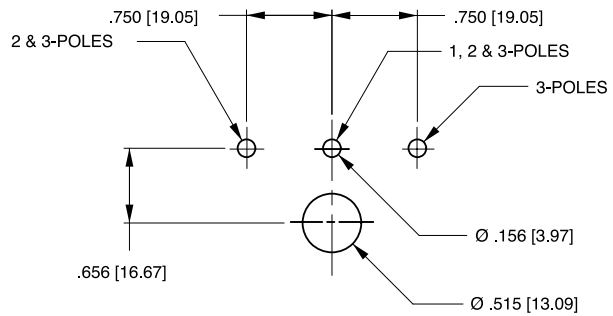
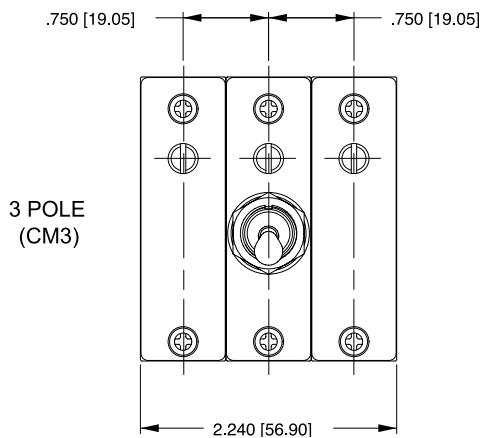
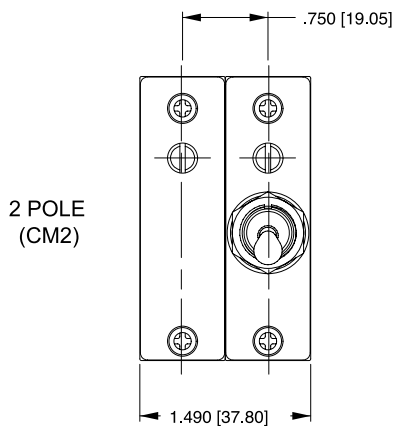

PANEL CUTOUT DETAIL  
 TOLERANCES ±.005[.13]

Notes:

- 1 All dimensions are in inches [millimeters].
- 2 Tolerance ±.020 [.51] unless otherwise specified.

## Circuit & Terminal Diagrams: in. [mm]

CIRCUIT BREAKER PROFILE	CIRCUIT SCHEMATIC		CIRCUIT CODE	AUX SWITCH CODE	CIRCUIT SCHEMATIC		CIRCUIT CODE	AUX SWITCH CODE
	ANSI	IEC			ANSI	IEC		
<p>SERIES TRIP (2 TERM'S.)</p>	<p>SWITCH ONLY (NO COIL)</p>		A	0	<p>SWITCH TRIP</p>		BC	0
<p>SERIES TRIP W/AUX. SWITCH (5 TERM'S.)</p>	<p>SWITCH ONLY (NO COIL) WITH AUXILIARY SWITCH</p>		A	2 3 4	<p>SERIES TRIP WITH AUXILIARY SWITCH</p>		BC	2 3 4
<p>SHUNT TRIP (3 TERM'S.)</p>	<p>SHUNT TRIP</p>		DE	0	<p>DUAL COIL; SERIES TRIP CURRENT COIL, SHUNT TRIP VOLTAGE COIL</p>		H	0
<p>SHUNT TRIP (4 TERM'S.)</p>	<p>RELAY TRIP</p>		FG	0	<p>DUAL COIL; SERIES TRIP CURRENT COIL, RELAY TRIP VOLTAGE COIL</p>		K	0

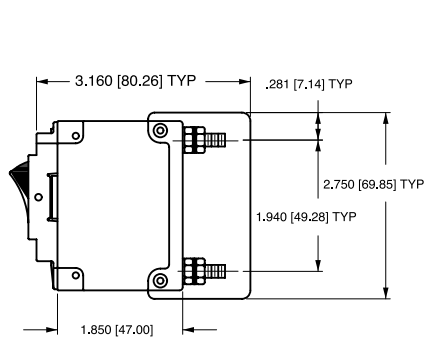

BARRIER FOR  
UL-RECOGNIZED MULTI-POLE  
BREAKERS

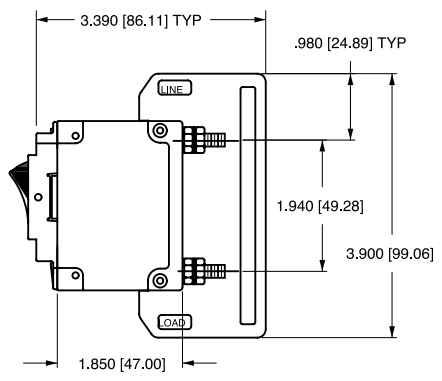

BARRIER FOR  
UL-489 LISTED MULTI-POLE  
BREAKERS

- Notes:
- 1 All dimensions are in inches [millimeters].
  - 2 Tolerance  $\pm 0.020$  [.51] unless otherwise specified.
  - 3 Schematic shown represents current trip circuit.



## Dimensional Specifications: in. [mm]

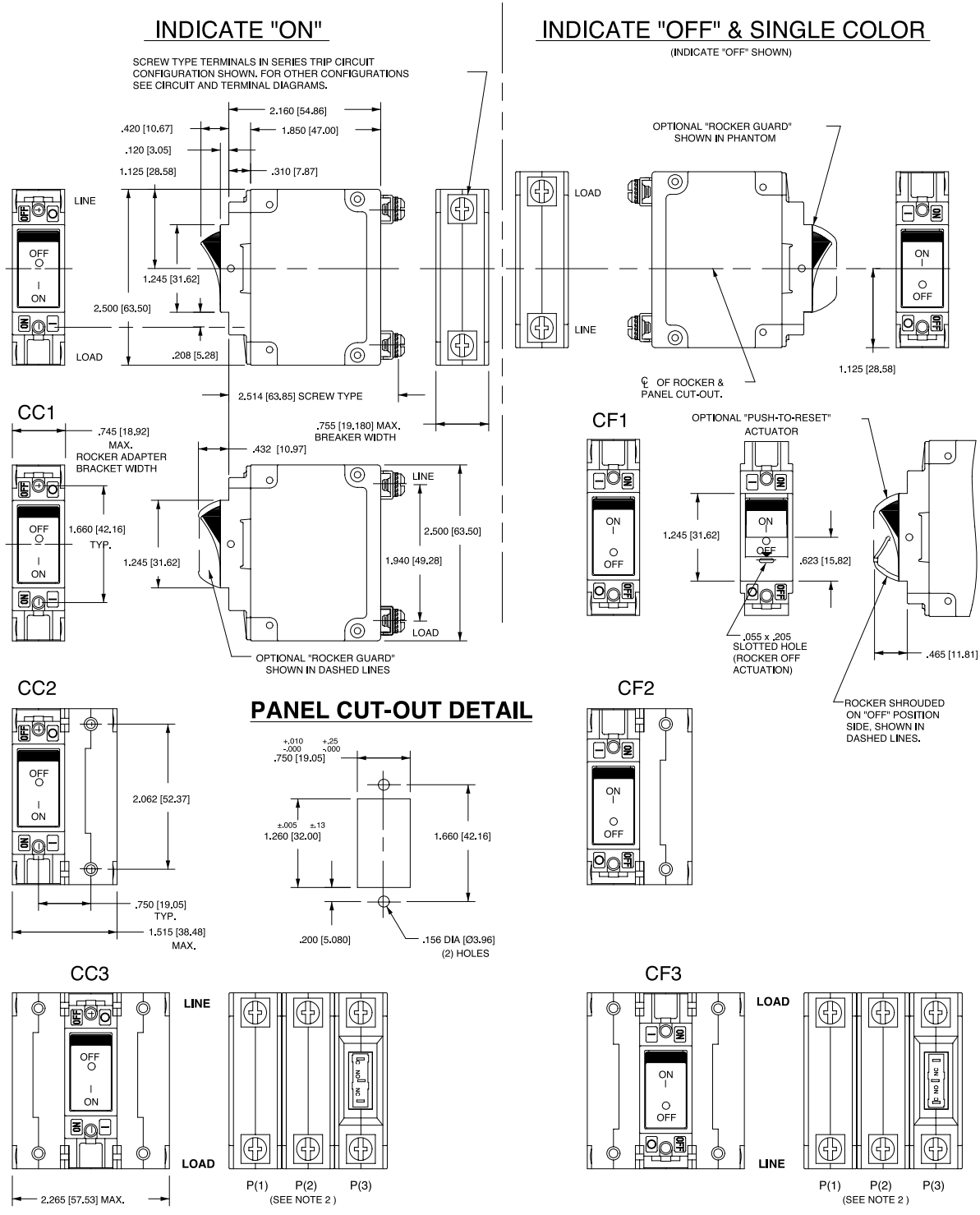

REAR VIEW OF INDICATE "ON" SERIES TRIP W/ AUX SWITCH CIRCUIT CONFIGURATION.

REAR VIEW OF INDICATE "OFF" SERIES TRIP W/ AUX SWITCH CIRCUIT CONFIGURATION.

- Notes:
- 1 Dimensions apply to all variations shown. Notice that circuit breaker line and load terminal orientation on indicate OFF is opposite of indicate ON.
  - 2 For pole orientation with horizontal legend, rotate front view clockwise 90°.
  - 3 All dimensions are in inches [millimeters].
  - 4 Tolerance  $\pm 0.020$  [51] unless otherwise specified.

## Dimensional Specifications: in. [mm]

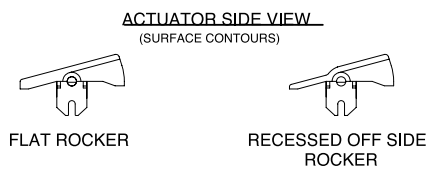
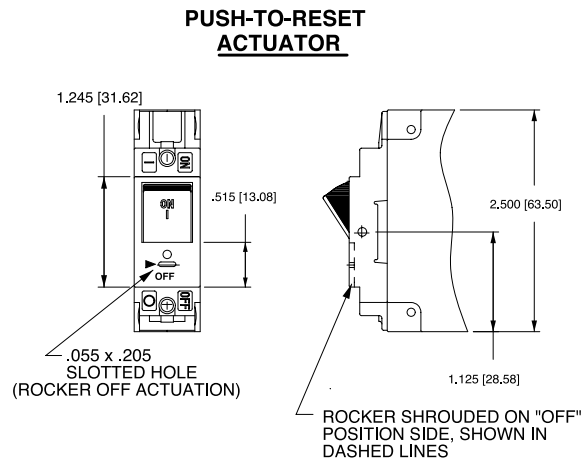
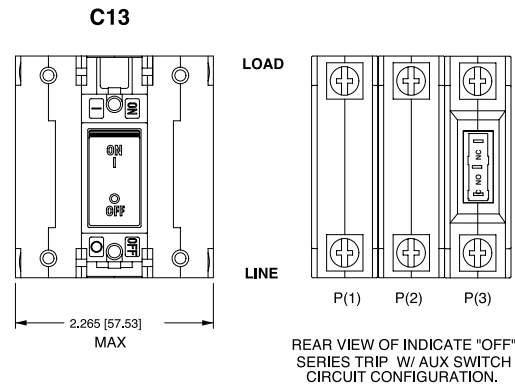
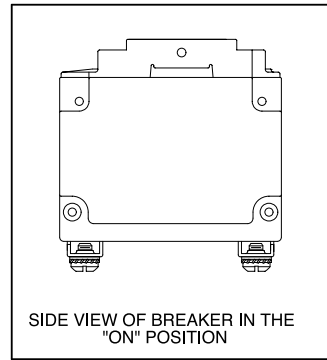
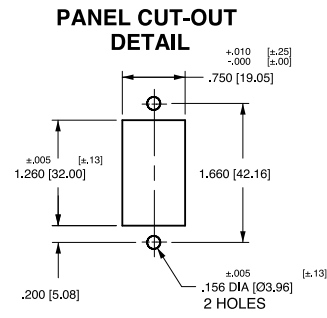
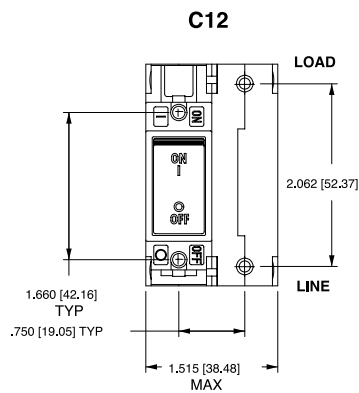
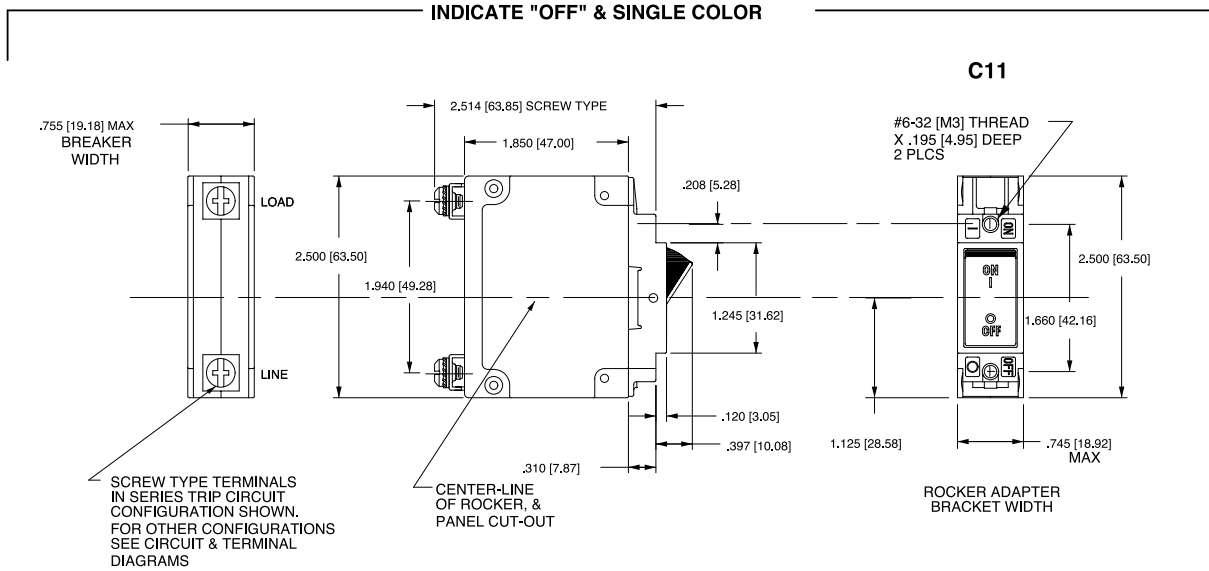

- Notes:
- 1 For pole orientation with horizontal legend, rotate front view clockwise 90°.
  - 2 All dimensions are in inches [millimeters].
  - 3 Tolerance ±.020 [.51] unless otherwise specified.

# F-Series

## F-Series

### CIRCUIT BREAKER

The F-Series hydraulic-magnetic high amperage circuit breakers are designed to handle high current applications in extremely hot and/or cold locations. Due to its time-proven hydraulic-magnetic design, the F-Series load sensing mechanism is insensitive to changes in ambient or enclosure temperature, providing a consistent trip point over temperatures ranging from  $-40^{\circ}\text{C}$  to  $+85^{\circ}\text{C}$ . Additionally, the F-Series circuit breakers come with a choice of overload time delays, making them ideal for critical applications having inductive loads.

Further, the F-Series breakers are available up to 700A and an optional 25 millivolt metering shunt construction provides a safe method for monitoring current flowing through the breaker by simply connecting a meter with light gauge wire to the appropriate terminals located on the shunt housing at the rear of the breaker. Applications can be customized by measuring and displaying percentage of current, watts or safe/danger zones.

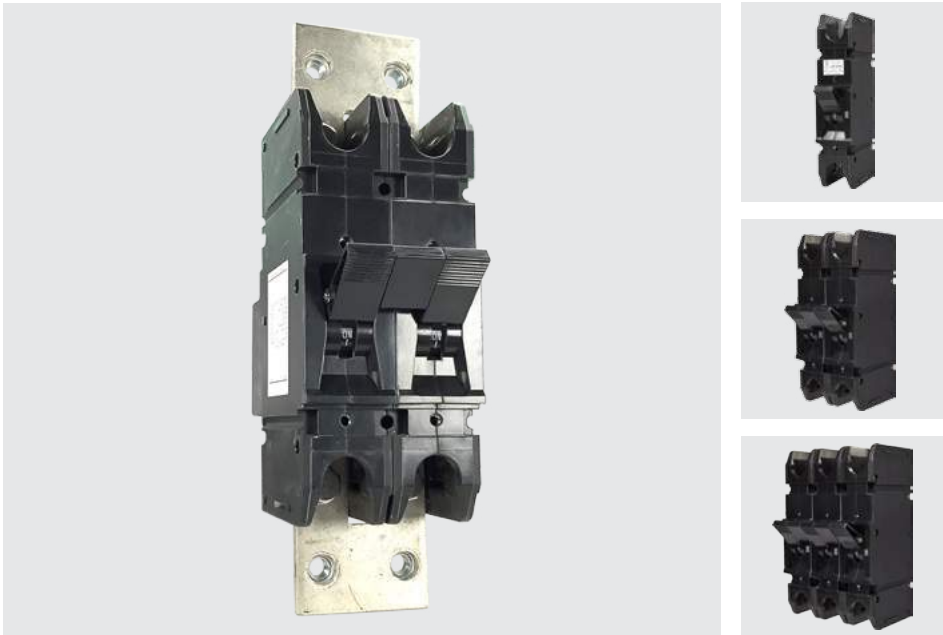

#### Product Highlights:

- AC ratings to UL 489
- DC voltage ratings up to 700A with metering shunt section
- Consistent trip point over temperatures ranging from  $-40^{\circ}\text{C}$  to  $+85^{\circ}\text{C}$
- Optional 25 millivolt metering shunt construction

### Electrical

Maximum Voltage	125VDC, 277VAC
Current Ratings	Standard current coils: 100, 125, 150, 175, 225, 250 amps. 300, 350, 400, 500, 600, 700 amps available as parallel pole construction.
Auxiliary Switch Rating	SPDT; 10.1 Amps @ 250VAC, 1.0 Amps @ 65VDC, 0.5 Amps @ 80VDC 0.1 Amps @ 125VAC (with gold contacts).
Insulation Resistance	Minimum: 100 Megohms at 500 VDC
Dielectric Strength	1960 VAC, 50/60 Hz for one minute between all electrically isolated terminals, except 2500 VAC for one minute between alarm/aux. switch and main terminals with contacts in open and closed position. F-Series circuit breakers comply with the 8mm spacing & 3750VAC 50/60 Hz dielectric requirements from hazardous voltage to operator accessible surfaces, between adjacent poles and from main circuits to auxiliary circuits per Publications EN 60950 and VDE 0805.
Resistance, Impedance	Values from Line to Load Terminal - based on Series Trip Circuit Breaker.

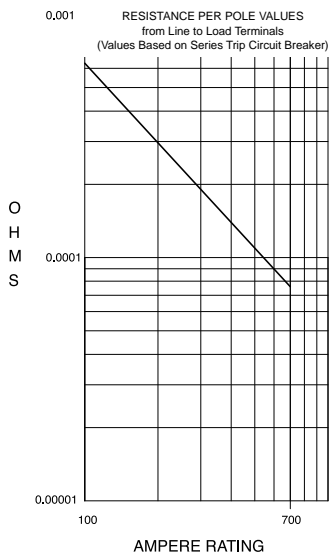

CURRENT (AMPS)	TOLERANCE (%)
100 - 700	50

### Mechanical

Endurance	4000 ON-OFF operations with rated Current & Voltage & 4000 operations with no load (8000 operations total) @ 5 per minute. Parallel Pole construction: 1000 operations with rated Current and Voltage @ 5 per minute.
Trip Free	All F-Series Circuit Breakers will trip on overload, even when the actuator is forcibly held in the ON position.
Trip Indication	The operating actuator moves positively to the OFF position when an overload causes the circuit breaker to trip.

### Physical

Number of Poles	1 - 3 Poles Note: Ratings over 250 Amps only available with parallel pole.
Internal Circuit Config.	Series (with or without auxiliary switch), Switch Only (with or without auxiliary switch).
Available Accessories	Factory installed: DC Current Metering Shunt (25 mV @Ir)
Weight	Varies depending on construction. Consult factory.
Standard Colors	Housing - Black; Actuator- Black or White with contrasting ON-OFF legend.

### Environmental

Designed and tested in accordance with requirements of specification MIL-PRF-55629 & MIL-STD-202 as follows:

Shock	Withstands 100 Gs, 6ms, sawtooth while carrying rated current per Method 213, Test Condition "I". Instantaneous and ultra-short curves tested @ 90% of rated current.
Vibration	Withstands 0.060" excursion from 10-55 Hz, and 10 Gs 55-500 Hz, at rated current per Method 204C, Test Condition A. Instantaneous and ultrashort curves tested at 90% of rated current.
Moisture Resistance	Method 106D; ten 24-hour cycles @ +25°C to +65°C, 80-98% RH.56 days @ +85°C, 85% RH.
Salt Spray	Method 101, Condition A (90-95% RH @ 5% NaCl Solution, 96 hrs).
Thermal Shock	Method 107D, Condition A (Five cycles @ -55°C to +25°C to +85°C to +25°C).
Operating Temperature	-40° C to +85° C

\*Manufacturer reserves the right to change product specification without prior notice.

### Electrical Tables

**Table A:** Lists UL Listed (489) and CSA Certified (C22.2 N0. 5.1-M) configurations and performance capabilities as a Molded Case Circuit Breaker

F SERIES TABLE A : UL489 LISTED BRANCH CIRCUIT BREAKERS						
CIRCUIT CONFIGURATION	VOLTAGE			CURRENT RATING FULL LOAD AMPS	INTERRUPTING CAPACITY (AMPS)	
	MAX RATING	FREQUENCY	PHASE		UL / CSA 1 - 3 POLES	TUV <sup>2</sup> 1 or 2 POLES
SERIES	125	DC	---	50 - 250	50,000	25,000
	120 / 240 <sup>1</sup>	50 / 60	1	100 - 250	10,000	---
	277	50 / 60	1	100 - 250	10,000	---
	208Y / 120	50 / 60	3	100 - 250	10,000	---

Notes:  
 1 120/240V rating available in 2 or 3 poles. In a 3 pole construction the center pole is Neutral.  
 2 TUV constructions are not available with AC ratings and 150-250 amp ratings only.

**Table B:** Lists UL Listed configurations and performance capabilities as Circuit Breakers for use in Communications Equipment (Guide DITT, File E189195), under UL489A

F-SERIES TABLE B : UL489 LISTED BRANCH CIRCUIT BREAKERS				
CIRCUIT CONFIGURATION	VOLTAGE		CURRENT RATING FULL LOAD AMPS	INTERRUPTING CAPACITY (AMPS) WITHOUT BACKUP FUSE
	MAX. RATING	FREQUENCY		
SERIES	125	DC	251 - 700	50,000

### Agency Certifications

**UL Listed**

UL 489



Circuit Breakers , Molded Case (Guide DIVQ, File E129899) Complies with the requirements of the CSA Standard for Molded Case Circuit Breakers,

CANCSA- C22.2 No. 5.1 –M

Circuit Breakers for Use in Communications Equipment (Guide DITT, File E189195)

**TUV Certified**



IEC 60947-2

Low Voltage Switchgear and Control Gear under TUV License No. R72031058

UL 489A



# F-Series Circuit Breaker - Handle – Ordering Scheme

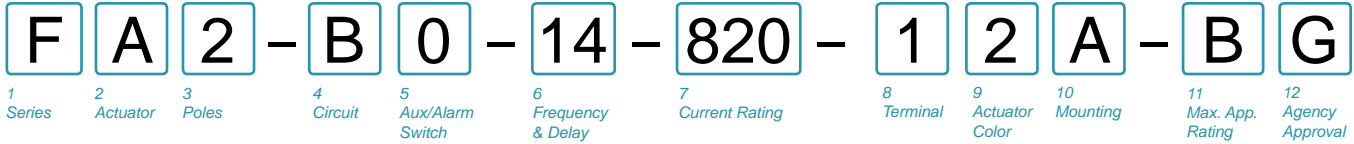

**1 SERIES**  
F

**2 ACTUATOR**  
A Handle, one per pole  
S Mid-Trip Handle, one per pole  
T Mid-Trip Handle, one per pole & Alarm Switch

**3 POLES**  
1 One                            2 Two                            3 Three

**4 CIRCUIT**

A <sup>1</sup> Switch Only (no coil)	M <sup>3,4</sup> Series Trip (Current) with Metering Shunt
S Series Trip (current)	N <sup>3,4</sup> Switch Only with Metering Shunt
C <sup>2</sup> Series Trip (voltage)	P <sup>3</sup> Series Trip (Current)
	Q <sup>3</sup> Switch Only

**5 AUXILIARY SWITCH<sup>5</sup>**

0 without Auxiliary Switch	7 S.P.S.T. 0.110 Q.C. Terminals (Gold Contacts)
2 S.P.D.T. 0.110 Q.C. Terminals	8 S.P.S.T. 0.187 Q.C. Terminals
3 S.P.D.T. 0.139 Solder Lug	9 S.P.D.T. 0.187 Q.C. Terminals
4 S.P.D.T. 0.110 Q.C. Terminals (Gold Contacts)	A <sup>6</sup> S.P.S.T., 0.093 Round QC Terminals
5 S.P.S.T., 0.093 Q.C. Terminals (Gold Contacts)	B <sup>6</sup> S.P.D.T., 0.093 Round QC Terminals
6 S.P.S.T. 0.110 Q.C. Terminals	

**6 FREQUENCY & DELAY**

03 DC 50/60Hz, Switch Only	14 DC Medium
10 <sup>7</sup> DC Instantaneous	16 DC Long
11 DC Ultra Short	22 AC Short
12 DC Short	24 AC Medium
	26 AC Long

**7 CURRENT RATING (AMPERES)**

CODE AMPERES			
810 100.000	820 200.00	835 <sup>8</sup> 350.00	860 <sup>8</sup> 600.00
912 125.00	922 225.00	840 <sup>8</sup> 400.00	870 <sup>8</sup> 700.00
815 150.00	825 250.00	845 <sup>8</sup> 450.00	
917 175.00	830 <sup>8</sup> 300.00	850 <sup>8</sup> 500.00	

**OR VOLTAGE COIL (MIN. TRIP RATING, VOLTS)<sup>7</sup>**

CODE AMPERES			
A06 6 DC, 5 DC	A24 24 DC, 20 DC	A65 65 DC, 55 DC	
A12 12 DC, 10 DC	A32 32 DC, 25 DC	B25 125 DC, 100 DC	
A18 18 DC, 15 DC	A48 48 DC, 40 DC	J06 6 AC, 5 AC	

**8 TERMINAL**

<b>Back Connected (Front Mounted Only)</b>	<b>Max Rating</b>
1 <sup>9</sup> 3/8-16 Stud	250A
2 <sup>14</sup> 3/8-16 Screw, Line & Load	700A
5 <sup>14</sup> 3/8-16 Short Stud	250A
<b>Front Connected (Back Mounted Only)<sup>11</sup></b>	<b>Max Rating</b>
3 Box Wire Connector, Line & Load	700A
4 <sup>14</sup> 3/8-16 Screw, Line & Load	700A

**9 ACTUATOR COLOR & LEGEND<sup>12,13</sup>**

<b>Actuator Color</b>	<b>I-O</b>	<b>ON-OFF</b>	<b>Dual</b>	<b>Marking Color</b>
White	A	B	1	Black
Black	C	D	2	White

**10 MOUNTING**

<b>Front Mounting Inserts</b>	<b>Back Mounting Inserts</b>
A 10-32	10-32 screw clearance holes
B ISO M5	10-32 screw clearance holes

**11 MAXIMUM APPLICATION RATING**

	<b>VOLTAGE</b>	<b>CURRENT</b>
B	125 VDC	700A
C <sup>15</sup>	120/240	250A
F	277 VAC	250A
7 <sup>16</sup>	120/208 VAC	250A

**12 AGENCY APPROVAL**

A	No approvals
G	UL489 Listed & CUL Certified
J	UL489 Listed, CUL Certified & TUV Certified
T	UL489A (Telecom) Listed

- Notes:
- For 100 to 250 amps, select Current Code 825. For 300-400 amps, select Current Code 840. For 450-700 amps, select Current Code 870.
  - Available with Frequency and Delay code 10 or 20 only, and are not rated for continuous duty. Delay 10 and 20 are only available with voltage coils.
  - 3 Codes M, N, P & Q (Parallel Poles) are supplied with factory installed Bus Bar on Line and Load.
  - 4 Metering terminals are female pin type, ref. Molex part number 02-09-1101, model 1189-T.
  - Auxiliary Switch breakers are only available with Series Trip and Switch Only circuits. On multi-pole breakers, one Auxiliary Switch is supplied, mounted in the extreme right pole per figure A. Back-Mounted breakers require special mounting provisions when an Auxiliary Switch is specified.
  - Available with parallel pole construction (circuit codes P and Q, and breakers with circuit codes M and N).
  - Frequency and delay code 10 is only available with Voltage Coils. Voltage Coils are not rated for continuous duty.
  - Ratings over 250 amps are only available with Agency Approval code T (UL489A) and are Parallel Pole configuration (circuit codes M, N, P and Q.) 300-450 amp ratings are available on two pole breakers. 500-700 amp ratings are available on three pole breakers.
  - Per UL requirement, an "Anti-Flash Over Barrier" is supplied between poles on multipole breakers with 3/8 - 16 stud terminals (Terminal Code 1) on AC rated breakers only.
  - Front connected breakers can also be front mounted by utilizing the supplied front panel mounting inserts. Terminal connections must be made before mounting.
  - Box Wire connector will accept #6 through 250 MCM copper wire.
  - Agency codes G & T must have ON-OFF or dual legends. Agency code J must have dual legend.
  - Other colors available. Consult factory.
  - Terminals 2,4 & 5 are shipped without terminal hardware.
  - 2 or 3 Pole Circuit Breaker Required for 120/240 VAC Rating.
  - 3 Pole Circuit Breaker Required for 120/208 VAC Rating.

## Circuit & Terminal Diagrams: in. [mm]

### F SERIES NON-PARALLEL POLE CONSTRUCTION:

CIRCUIT BREAKER PROFILE	CIRCUIT SCHEMATIC		CIRCUIT CODE	AUX. SWITCH CODE	CIRCUIT SCHEMATIC		CIRCUIT CODE	AUX. SWITCH CODE
	ANSI	IEC			ANSI	IEC		
<p>SERIES TRIP (2 TERM.S.)</p>			A	0			BC	0
<p>SERIES TRIP W/AUX. SWITCH (5 TERM.S.)</p>			A	2 3 4 5 9			BC	2 3 4 5 9

### TERMINAL DETAILS BACK CONNECT

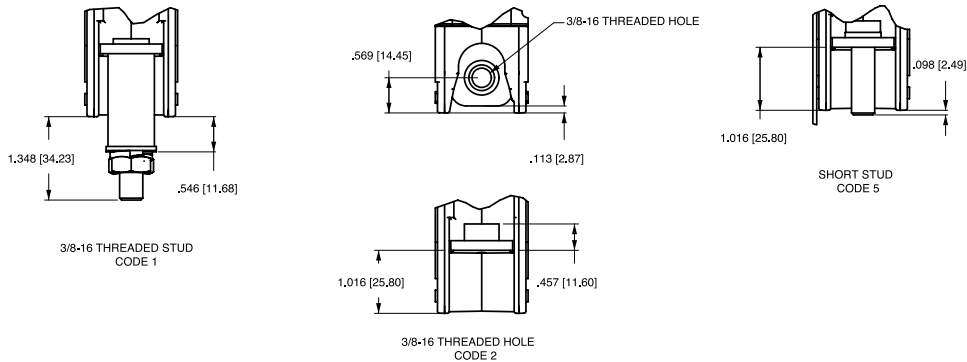

### FRONT CONNECT

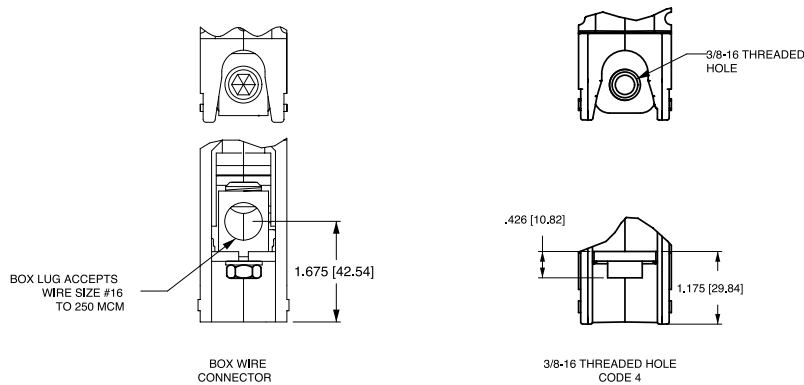

Notes:

- 1 All dimensions are in inches [millimeters].
- 2 Tolerance  $\pm .020$  [.51] unless otherwise specified.

# Circuit & Terminal Diagrams: in. [mm]

## F-SERIES PARALLEL POLE CONSTRUCTION:

CIRCUIT BREAKER PROFILE	CIRCUIT SCHEMATIC		CIRCUIT CODE	AUX SWITCH CODE	CIRCUIT SCHEMATIC		CIRCUIT CODE	AUX SWITCH CODE
	ANSI	IEC			ANSI	IEC		
<p>SERIES TRIP (2 TERMS.)</p>	<p>SWITCH ONLY (NO COIL)</p>	<p>LINE (NETZ)</p>	A	0	<p>SERIES TRIP</p>	<p>LINE (NETZ) (3)</p>	BC	0
<p>SERIES TRIP W/AUX. SWITCH (5 TERMS.)</p>	<p>SWITCH ONLY (NO COIL) WITH ALARM OR AUX. SWITCH</p>	<p>LINE (NETZ)</p>	A	B	<p>SERIES TRIP WITH ALARM OR AUX. SWITCH</p>	<p>LINE (NETZ) (3)</p>	BC	B
<p>SERIES TRIP W/METERING SHUNT (4 TERMS.)</p> <p>(FOR 100-225 AMPS DIM = 2.000)</p>	<p>SWITCH ONLY (NO COIL) WITH METERING SHUNT</p>	<p>LINE (NETZ) (3)</p>	N	0	<p>SERIES TRIP CURRENT COIL WITH METERING SHUNT</p>	<p>LINE (NETZ) (3)</p>	M	0
<p>RELAY TRIP (4 TERMS.)</p>	<p>SWITCH ONLY WITH ALARM OR AUX. SWITCH AND METERING SHUNT</p>	<p>LINE (NETZ) (3)</p>	N	A	<p>SERIES TRIP WITH ALARM OR AUX. SWITCH AND METERING SHUNT</p>	<p>LINE (NETZ) (3)</p>	M	A

- Notes:
- 1 All dimensions are in inches [millimeters].
  - 2 Tolerance  $\pm 0.020$  [.51] unless otherwise specified.



## Dimensional Specifications: in. [mm]

### SERIES TRIP BACK CONNECT (STUD TERMINALS SHOWN)

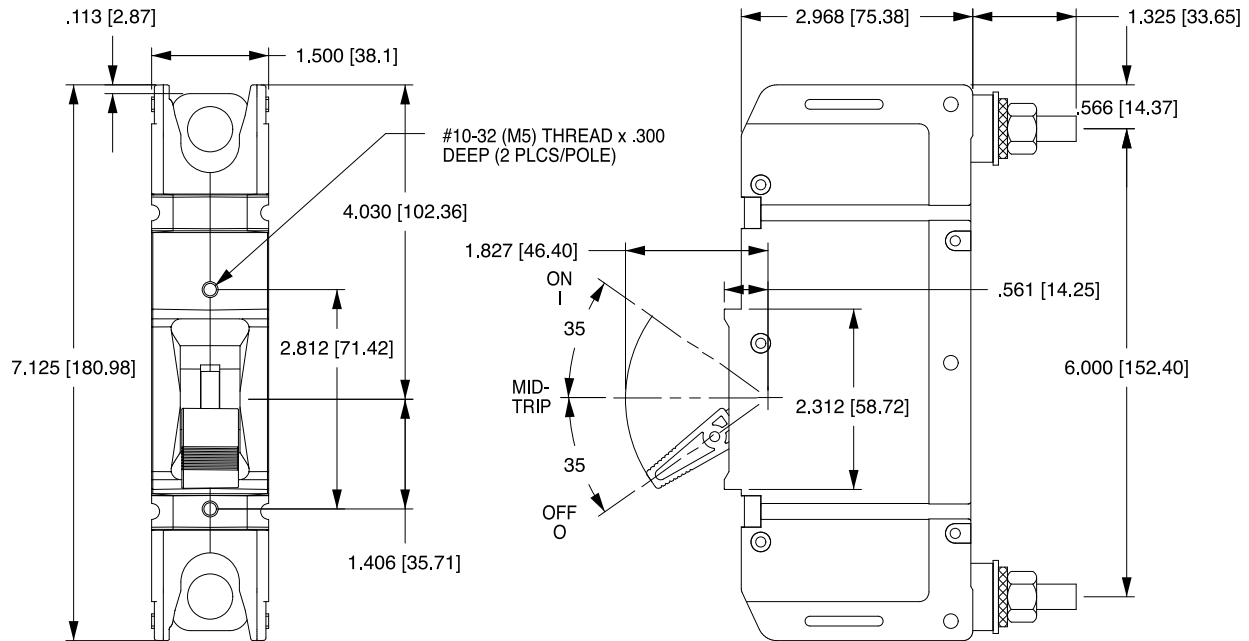

### MULTIPOLE SERIES TRIP, SHOWING TERMINAL BARRIER

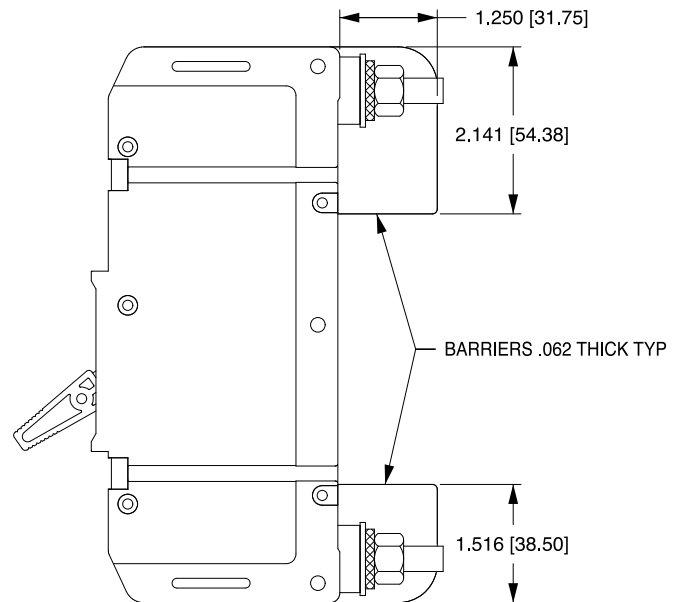
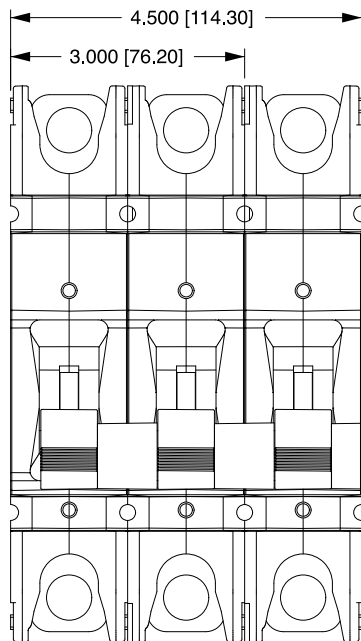

Notes:

- 1 All dimensions are in inches [millimeters].
- 2 Tolerance  $\pm 0.020$  [51] unless otherwise specified.

## Dimensional Specifications: in. [mm]

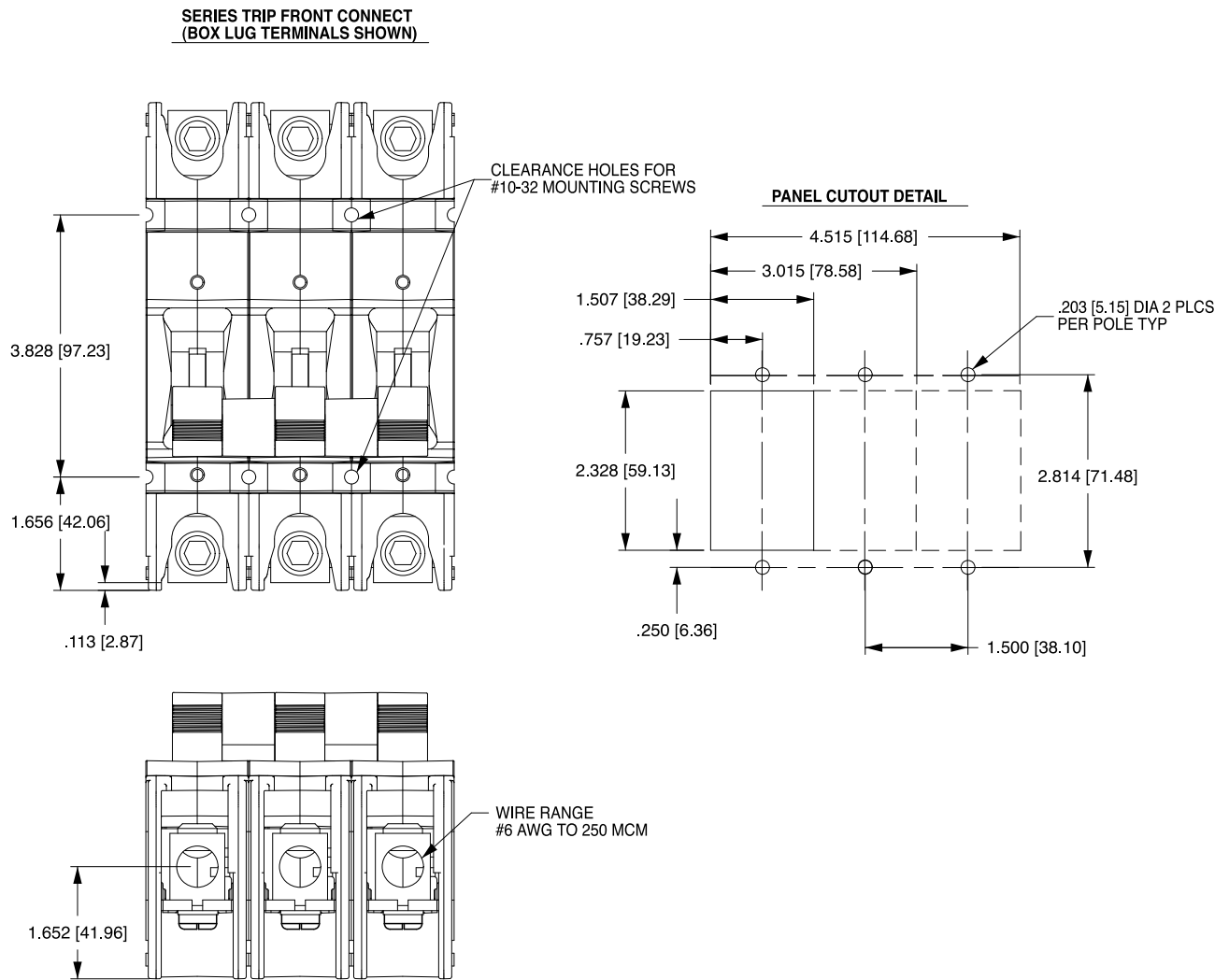

Notes:

- 1 All dimensions are in inches [millimeters].
- 2 Tolerance  $\pm 0.020$  [.51] unless otherwise specified.

## Dimensional Specifications: in. [mm]

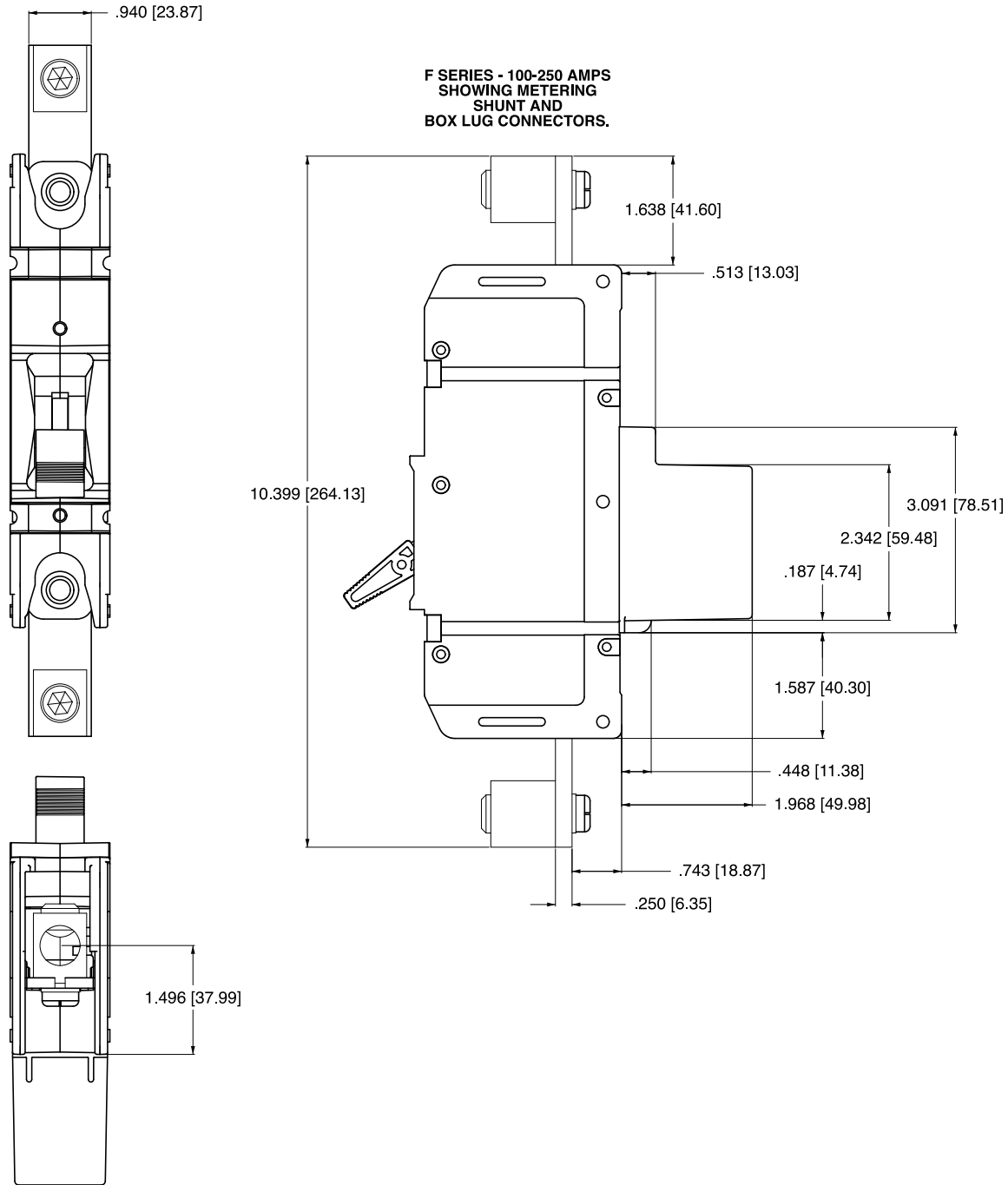

F-Series breakers are available up to 700A, and are also available with a 25 millivolt metering shunt construction. This optional construction provides a safe method for monitoring current flowing through the breaker by simply connecting a meter with light gauge wire to the appropriate terminals located on the shunt housing at the rear of the breaker. You can customize the application by measuring and displaying percentage of current, watts or safe/danger zones.

**Notes:**

- 1 All dimensions are in inches [millimeters].
- 2 Tolerance  $\pm 0.020$  [.51] unless otherwise specified.

## Dimensional Specifications: in. [mm]

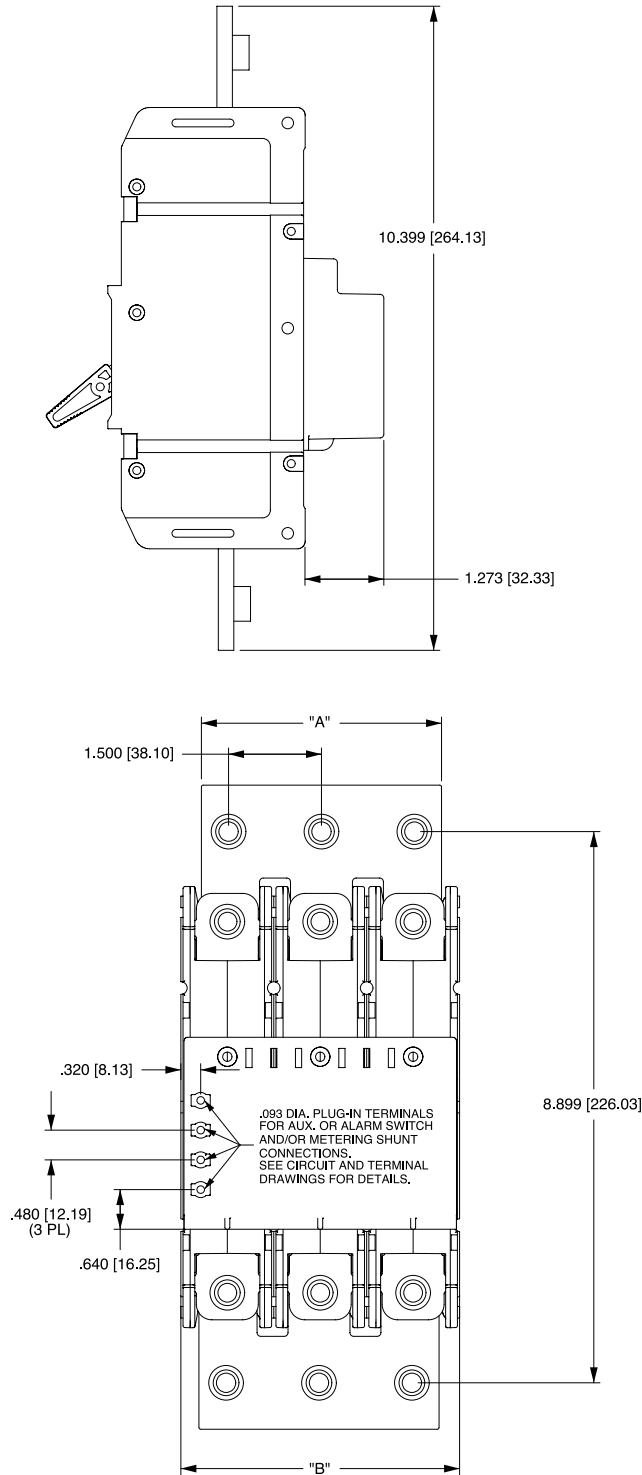

**F-SERIES PARALLEL POLE 250-700 AMPS  
SHOWING FRONT CONNECT SCREW TERMINALS**

- Notes:
- 1 All dimensions are in inches [millimeters].
  - 2 Tolerance  $\pm 0.020$  [.51] unless otherwise specified.

M, MS-SERIES TIME DELAY VALUES										
TRIP TIME SECONDS	PERCENT OF RATED CURRENT									
	Delay	100%	135%	150%	200%	400%	600%	800%	1000%	1200%
	10, 20, 30	No Trip	May Trip	.100 Max	.100 Max	.100 Max	.100 Max	.100 Max	.100 Max	.100 Max
12, 22, 32, 62, 72, 92	No Trip	.300 - 7.00	.200 - 5.00	.100 - 2.00	.030 - .500	.008 - .300	.006 - .150	.005 - .100	.005 - .100	.005 - .160
14, 24, 34, 64, 74, 94	No Trip	3.00 - 70.0	2.00 - 40.0	1.00 - 15.0	.100 - 4.00	.008 - 2.00	.006 - .800	.005 - .350	.005 - .160	.005 - .160

Notes:

- 1 Delay Curves 12,14, 22, 24, 32, 34, 62, 64, 72, 74, 92, 94: Breakers to hold 100% and must trip at 135% of rated current and greater within the time limit shown in this curve.
- 2 Delay Curves 10, 20, 30: Breakers to hold 100% and must trip at 150% of rated current and greater within the time limit shown in this curve.
- 3 All Curves: Curve data shown represents breaker response at ambient temperature of 77°F (25°C) with no preloading. Breakers are mounted in standard wall-mount position.
- 4 The minimum inrush pulse tolerance handling capability is 12 times the rated current on standard delays and 18 times the rated current on high inrush delays. These values are based on a 60 Hz 1/2 cycle, 8.33 ms pulse. High inrush delays should be specified for applications with high initial surge currents of short duration, such as switching power supplies, highly capacitive loads and transformer loads.

### Dual Rated AC/DC

#### Instantaneous

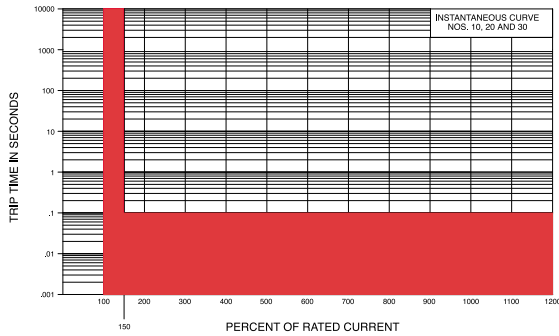

#### Short

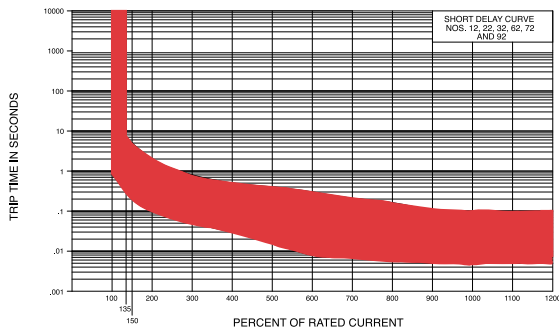

#### Short D2

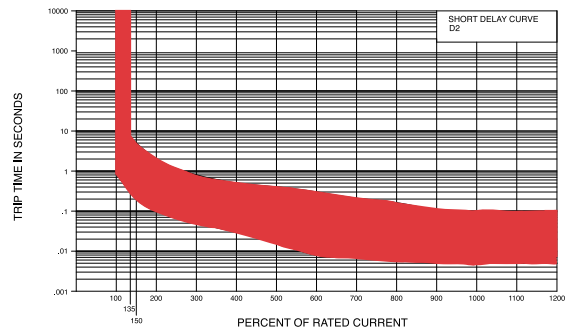

#### Medium

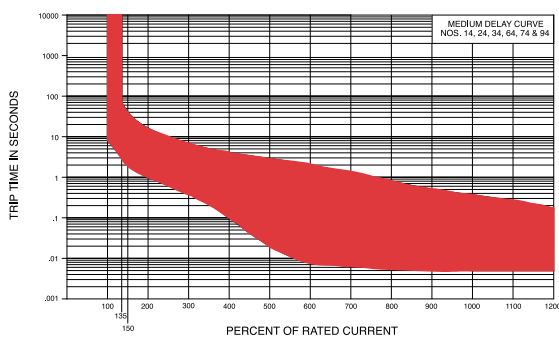

#### Medium D4

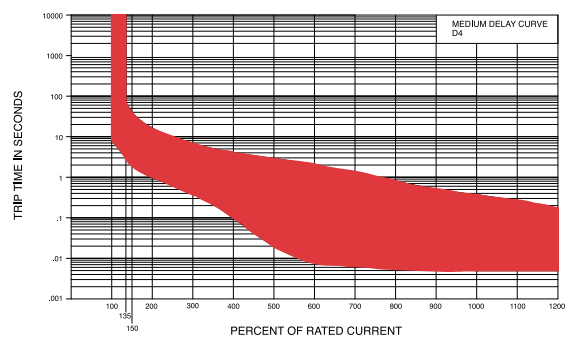

A, B, C, CX, D, G, H, L, N-SERIES TIME VALUES											
TRIP TIME (SECONDS)	PERCENT OF RATED CURRENT										
	DELAY	100%	125%	135%	150%	200%	400%	600%	800%	1000%	1200%
10	No Trip	May Trip	---	.032 MAX	.024 MAX	.020 MAX	.018 MAX	.016 MAX	.015 MAX	.013 MAX	
11	No Trip	.013 - .125	---	.010 - .070	.008 - .032	.006 - .020	.005 - .020	.004 - .020	.004 - .020	.004 - .020	
12	No Trip	.500 - 6.50	---	.300 - 3.00	.130 - 1.20	.031 - .220	.011 - .120	.004 - .090	.004 - .060	.004 - .040	
14	No Trip	2.00 - 60.0	---	1.20 - 40.0	.600 - 20.0	.150 - 3.00	.030 - 1.30	.004 - .600	.004 - .100	.004 - .100	
16	No Trip	45.0 - 345	---	20.0 - 150	9.00 - 60.0	1.40 - 11.4	.150 - 5.80	.009 - 3.70	.005 - 1.70	.005 - .500	
20	No Trip	May Trip	---	.040 MAX	.035 MAX	.030 MAX	.025 MAX	.020 MAX	.017 MAX	.015 MAX	
21	No Trip	.014 - .150	---	.011 - .095	.008 - .055	.006 - .035	.005 - .027	.005 - .021	.004 - .018	.004 - .017	
22	No Trip	.700 - 12.0	---	.350 - 4.00	.130 - 1.30	.027 - .220	.008 - .130	.004 - .090	.004 - .045	.004 - .040	
24	No Trip	10.0 - 160	---	6.00 - 60.0	2.20 - 20.0	.300 - 3.00	.050 - 1.30	.007 - .500	.005 - .060	.005 - .040	
26	No Trip	50.0 - 700	---	32.0 - 350	10.0 - 90.0	1.50 - 15.0	.500 - 7.00	.020 - 3.00	.006 - 2.00	.005 - 1.00	
32	No Trip	May Trip	.400 - 8.00	.300 - 4.00	.130 - 1.30	.027 - .220	.008 - .130	.004 - .090	.004 - .060	.004 - .040	
34	No Trip	May Trip	1.80 - 100	1.20 - 60.0	.600 - 20.0	.150 - 3.00	.030 - 1.30	.004 - .600	.004 - .110	.004 - .100	
36	No Trip	May Trip	35.0 - 520	20.0 - 350	9.00 - 90.0	1.40 - 15.0	.150 - 7.00	.009 - 3.70	.005 - 2.00	.004 - 1.00	
42	No Trip	.700 - 12.0	---	.400 - 6.00	.180 - 2.30	.050 - .600	.026 - .300	.018 - .200	.014 - .150	.012 - .130	
44	No Trip	7.00 - 100	---	3.00 - 50.0	1.10 - 18.0	.220 - 3.00	.120 - 1.70	.075 - 1.20	.050 - .850	.042 - .720	
46	No Trip	50.0 - 700	---	31.0 - 350	12.0 - 150	1.50 - 20.0	.700 - 10.0	.404 - 7.90	.260 - 6.50	.198 - 5.80	
52	No Trip	.500 - 6.50	---	.340 - 4.50	.180 - 2.30	.051 - .600	.030 - .320	.018 - .220	.014 - .200	.012 - .130	
54	No Trip	1.50 - 50.0	---	.750 - 35.0	.350 - 18.0	.110 - 3.00	.070 - 1.70	.045 - 1.40	.039 - 1.30	.035 - 1.30	
56	No Trip	45.0 - 345	---	19.0 - 170	8.50 - 100	1.24 - 15.0	.410 - 9.00	.256 - 8.00	.210 - 5.50	.198 - 2.90	

Notes:

UL489 C-Series Breakers available with Delay Curves 11, 12, 14, 16, 21, 22, 24, 26, 42, 44, 46.

Delay Curves 11,12,14,16,21,22,24,26,42,44,46,52,54,56: Breakers to hold 100% and must trip at 125% of rated current and greater within the time limit shown in this curve.

Delay Curves 32,34,36: Breakers to hold 100% and must trip at 135% of rated current and greater within the time limit shown in this curve.

Delay Curves 10,20: Breakers to hold 100% and must trip at 150% of rated current and greater within the time limit shown in this curve.

All Curves: Curve data shown represents breaker response at ambient temperature of 77°F (25°C) with no preloading. Breakers are mounted in standard wall-mount position.

On 50 amp and less current ratings, the minimum inrush pulse tolerance handling capability is 12 times the rated current on standard delays and 25 times the rated current on high inrush delays. These values are based on a 60 Hz 1/2 cycle, 8.33 ms pulse. High inrush delays should be specified for applications with high initial surge currents of short duration such as switching power supplies, highly capacitive loads and transformer loads.

AC

DC

Instantaneous

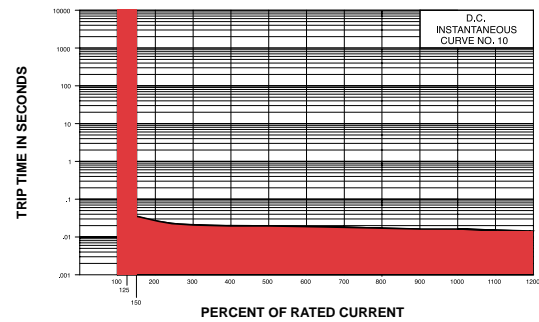
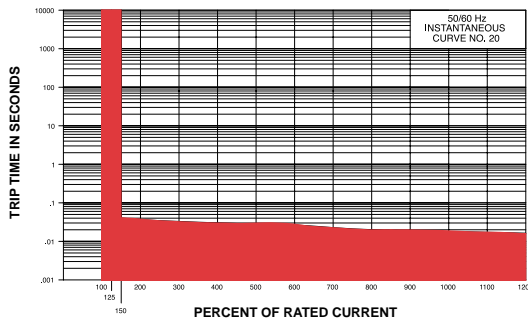

Ultrashort

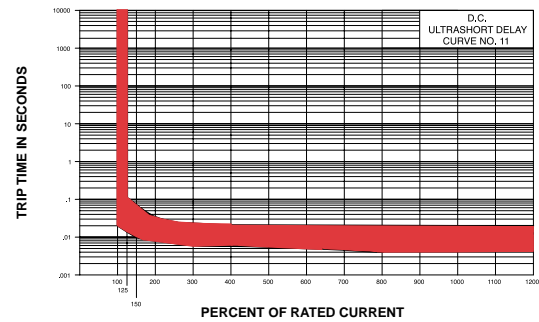
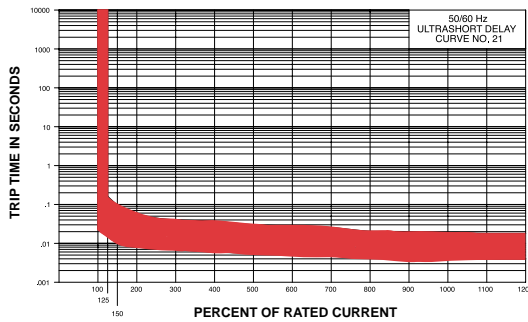

Short

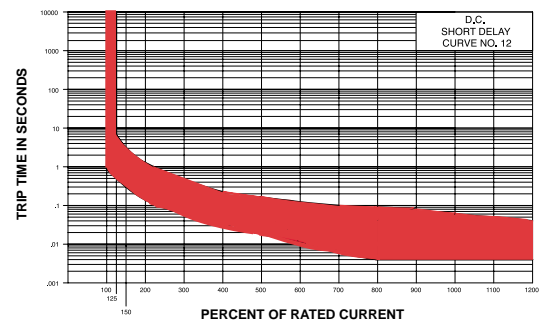
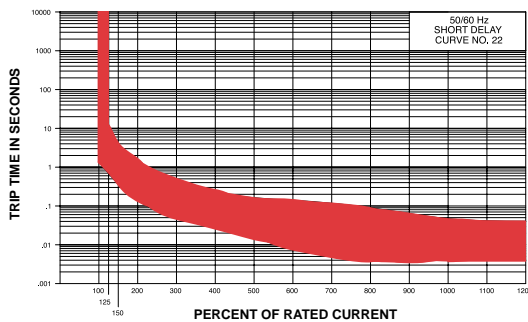

Medium

AC

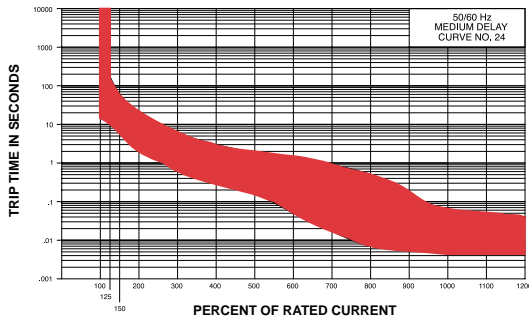

DC

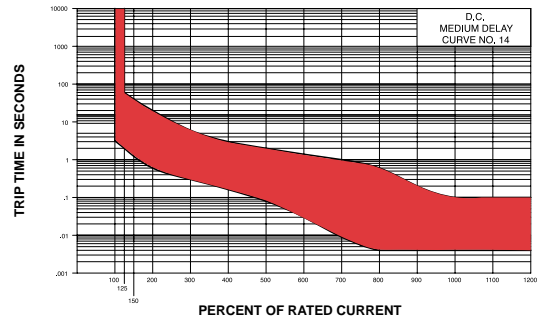

Long

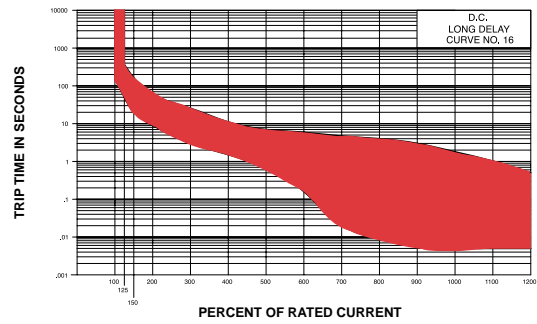
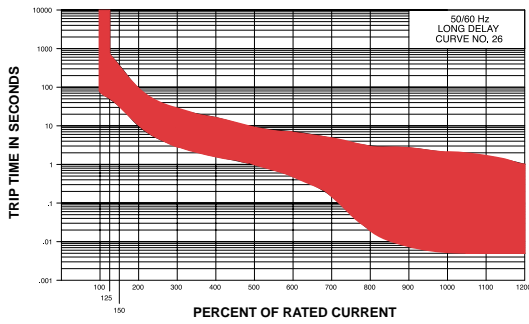

Short

High Inrush AC

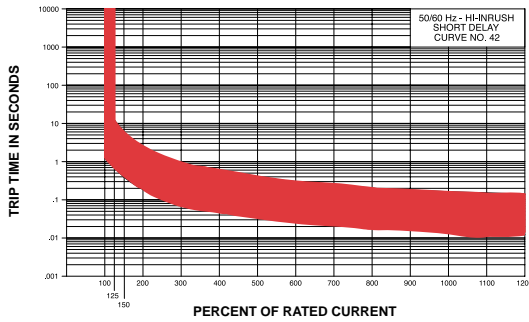

High Inrush DC

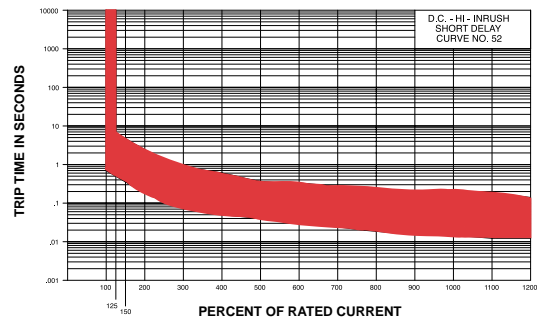

Medium

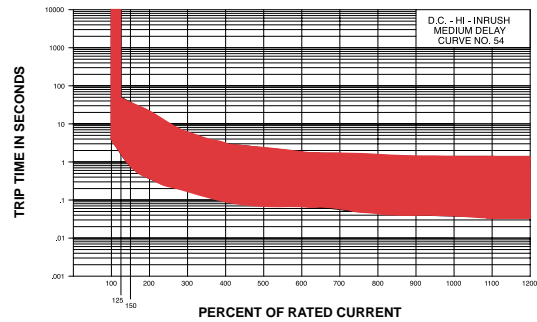
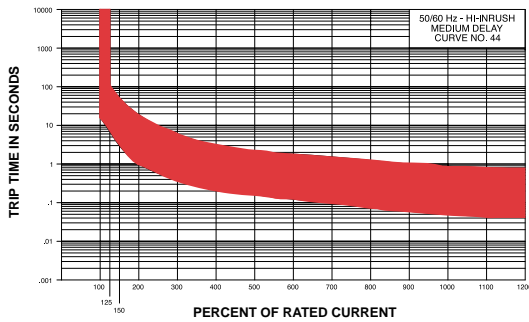

Long

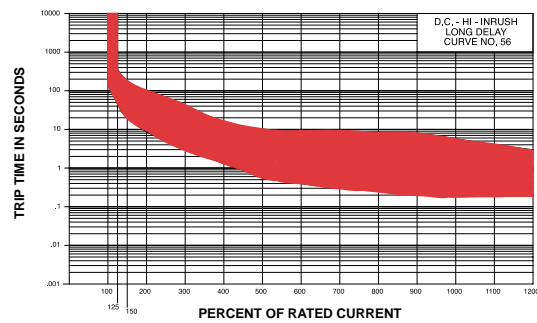
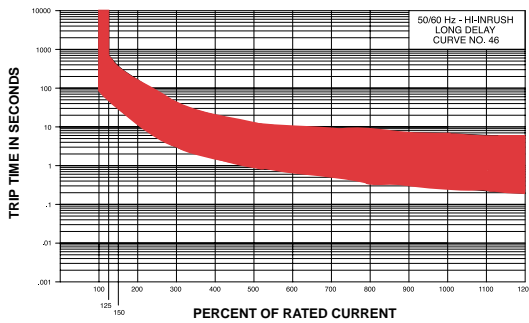

AC/DC

Short

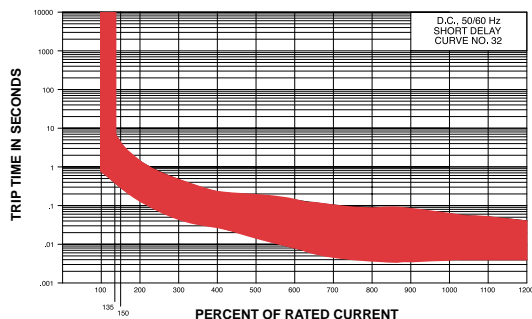

Medium

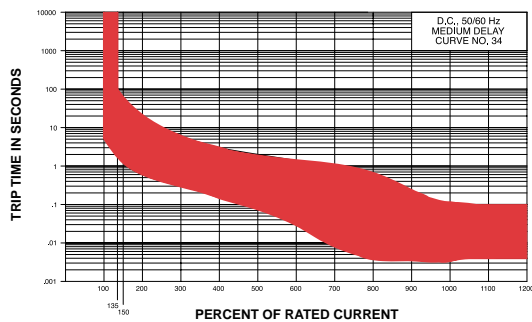

Long

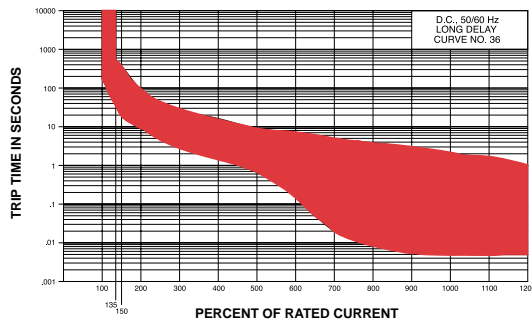



F-SERIES TIME DELAY VALUES									
TRIP TIME SECONDS	PERCENT OF RATED CURRENT								
	Delay	100%	125%	150%	200%	400%	600%	800%	1000%
11	No Trip	.013 - .125	.010 - .070	.008 - .032	.006 - .020	.005 - .020	.004 - .020	.004 - .020	.004 - .020
12	No Trip	.475 - 10.0	.275 - 2.80	.140 - .850	.030 - .190	.015 - .125	.010 - .050	.008 - .038	.008 - .038
14	No Trip	10.0 - 110	6.00 - 40.0	2.50 - 15.0	.500 - 3.00	.180 - 1.00	.010 - .280	.008 - .080	.008 - .080
16	No Trip	110 - 1000	60.0 - 400	22.0 - 150	4.00 - 25.0	1.00 - 5.50	.010 - 1.80	.008 - .390	.008 - .390
22	No Trip	.700 - 12.0	.350 - 4.00	.130 - 1.30	.027 - .220	.008 - .130	.004 - .090	.004 - .045	.004 - .045
24	No Trip	10.0 - 160	6.00 - 60.0	.220 - 20.0	.300 - 3.00	.050 - 1.30	.007 - .500	.005 - .060	.005 - .060
26	No Trip	50.0 - 700	32.0 - 350	10.0 - 90.0	1.50 - 15.0	.500 - 7.00	.020 - 3.00	.006 - 2.00	.006 - 2.00

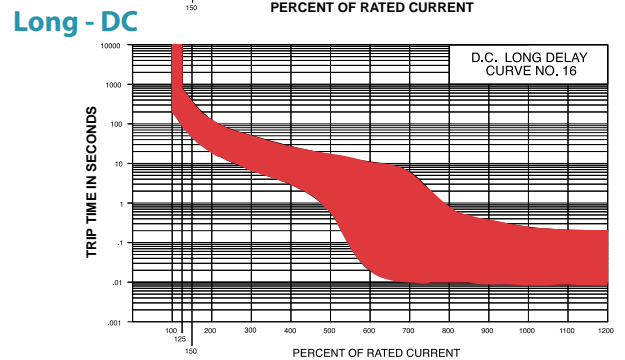
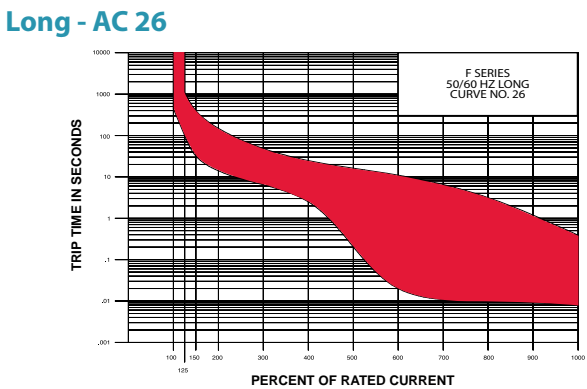
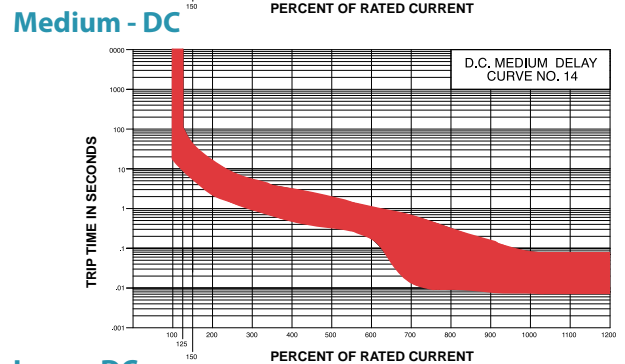
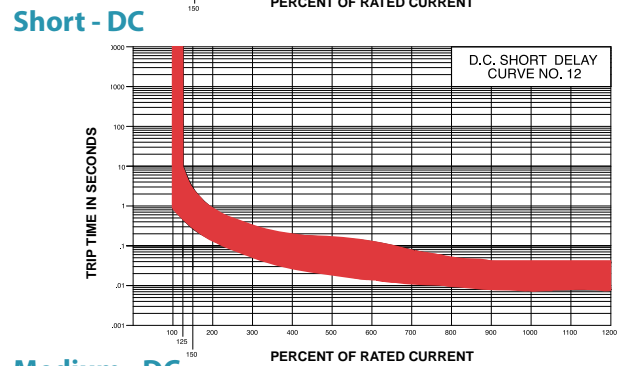
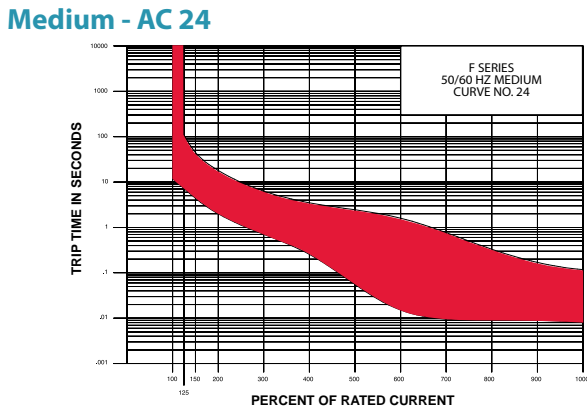
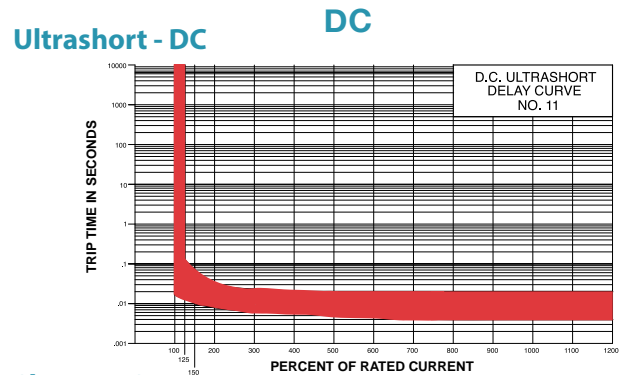
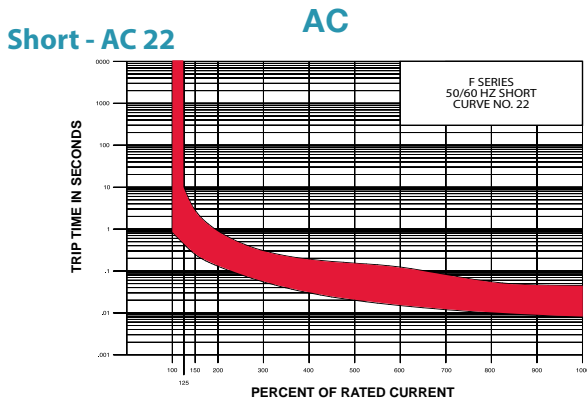

## Custom Power Distribution Units

Drawing on over 90 years of experience in the development of power switching and protection components, Carling Technologies offers custom designed and standard AC and DC power distribution units that exceed the tough demands of today's applications while still offering safety, reliability and performance.

A dedicated engineering team was established to provide design support and consultation to today's taxed engineering staffs. Our goal is to design and develop a custom Power Distribution Unit or Battery Disconnect Panel that will meet your special requirements. Utilizing a comprehensive range of quality circuit protection and control products, you can specify the physical size of the enclosure and add your component requirements including temperature stable Carling Technologies' hydraulic-magnetic circuit breakers, ground fault circuit protectors, transient voltage surge suppressors, meters, power receptacles, relays, bus bars, hole plugs and LED's.

Carling Technologies also offers a variety of standard AC Power Distribution Units and standard DC Power Distribution Units, including three different product series of one rack unit (1RU) panels designed to fit industry standard rack systems. All one rack unit products provide front access and utilize plug-in style circuit breakers that are "hot swappable."

A standard Battery Disconnect Panels with ratings up to 700 amps and interrupting capacity of 50,000A@ 125VDC is also available in sizes as small as 1RU x 19" and up to 3RU.

Carling Technologies' expertise in power distribution and electrical design can help you meet your power needs. Contact us with your requirements today.



### LAC1-Series

Versatile design allows custom configurations of branch circuits based on application Circuit breakers snap-in to Carling's exclusive circuit breaker mounting block, no need to hard wire breakers.



### LDC1-Series

Hot "swappable" circuit breakers that can be installed, changed, or replaced in the field or factory Circuit breakers are front panel accessible.



### LBD1-Series

Panel incorporates Carling F-Series high amperage hy-mag breakers, providing superior level of performance Panels sized for maximum protection in the smallest size possible to conserve valuable cabinet space, starting with a compact 1RU x 19" rack rated up to 250amps @ 125VDC with a 50,000AIC.

There are several catalogs available featuring complete details on all Carling Technologies products. Below is a list of useful information such as catalogs, brochures and videos. Please visit our website at **carlingtech.com** or scan the QR codes below for complete details.

### www.carlingtech.com



### Watch Company Profile Video



### Switches & Controls

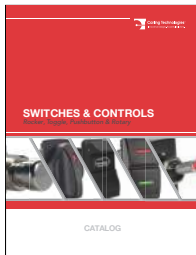

*catalog*

Complete line and ordering details for Switches & Control products including Rocker, Toggle, Pushbutton, and Rotary style switches.

### Hydraulic-Magnetic

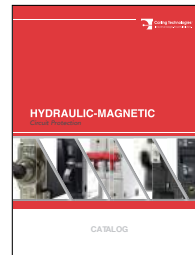

*catalog*

Complete line and ordering details for all hydraulic-magnetic circuit breakers.

### Thermal

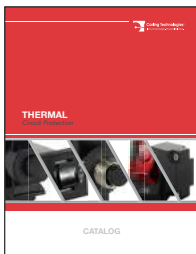

*catalog*

Complete line and ordering details for all thermal circuit breakers.

### GFCI / ELCI

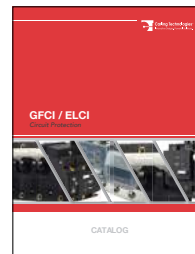

*catalog*

Complete line and ordering details for all GFCIs/ELCIs.

### Marine



catalog



brochure

Complete line of ELCIs, thermal and hydraulic-magnetic circuit breakers specific for marine applications.

### On-Off Highway



catalog



brochure

Complete line of switches, controls and custom solutions specific for on-off highway applications.

### Renewable Energy

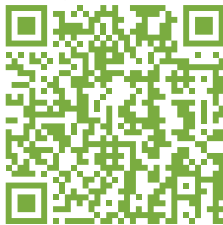
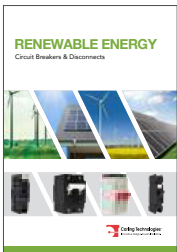

catalog



brochure

Complete line of circuit breakers and disconnect products specific for renewable energy applications.

### Military

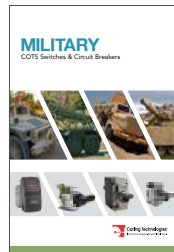

catalog



brochure

Complete line of COTS (*Commercial-Off-The-Shelf*) switches and circuit breakers specific for military applications.

### Telecom/Datacom



catalog



brochure

Complete line of hydraulic-magnetic circuit breakers specific for telecom/datacom applications.

### Industrial Automation

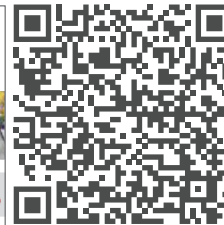

brochure

Complete line of switches and circuit breakers specific for industrial automation & controls applications.

## Authorized Sales Representatives and Distributors

Click on a region of the map below to find your local representatives and distributors or visit [www.carlingtech.com/findarep](http://www.carlingtech.com/findarep).



## About Carling

Founded in 1920, Carling Technologies is a leading manufacturer of electrical and electronic switches and assemblies, circuit breakers, electronic controls, power distribution units, and multiplexed power distribution systems. With four ISO registered manufacturing facilities and technical sales offices worldwide, Carling Technologies Sales, Service and Engineering teams do much more than manufacture electrical components, they engineer powerful solutions! To learn more about Carling please visit [www.carlingtech.com/company-profile](http://www.carlingtech.com/company-profile).

To view all of Carling's environmental, quality, health & safety certifications please visit [www.carlingtech.com/environmental-certifications](http://www.carlingtech.com/environmental-certifications)

## Worldwide Headquarters

Carling Technologies, Inc.  
60 Johnson Avenue, Plainville, CT 06062-1177  
**Phone:** 860.793.9281 **Fax:** 860.793.9231  
**Email:** sales@carlingtech.com www.carlingtech.com

**Northern Region Sales Office:** nrsm@carlingtech.com  
**Southeast Region Sales Office:** sersm@carlingtech.com  
**Midwest Region Sales Office:** mrrsm@carlingtech.com  
**West Region Sales Office:** wrsm@carlingtech.com  
**Latin America Sales Office:** larsm@carlingtech.com

## Asia-Pacific Headquarters

Carling Technologies, Asia-Pacific Ltd.,  
Suite 1607, 16/F Tower 2, The Gateway, Harbour City,  
25 Canton Road, Tsimshatsui, Kowloon, Hong Kong  
**Phone:** Int + 852-2737-2277 **Fax:** Int + 852-2736-9332  
**Email:** sales@carlingtech.com.hk

**Shenzhen, China:** shenzhen@carlingtech.com  
**Shanghai, China:** shanghai@carlingtech.com  
**Pune, India:** india@carlingtech.com  
**Kaohsiung, Taiwan:** taiwan@carlingtech.com  
**Yokohama, Japan:** japan@carlingtech.com

## Europe | Middle East | Africa Headquarters

Carling Technologies LTD  
4 Airport Business Park, Exeter Airport,  
Clyst Honiton, Exeter, Devon, EX5 2UL, UK  
**Phone:** Int + 44 1392.364422 **Fax:** Int + 44 1392.364477  
**Email:** ltd.sales@carlingtech.com

**Germany:** gmbh@carlingtech.com  
**France:** sas@carlingtech.com

