

REVISION HISTORY

ZONE	REV	DESCRIPTION	DATE	BY
-	00	ORIGINAL ISSUE	6/18/15	GCP

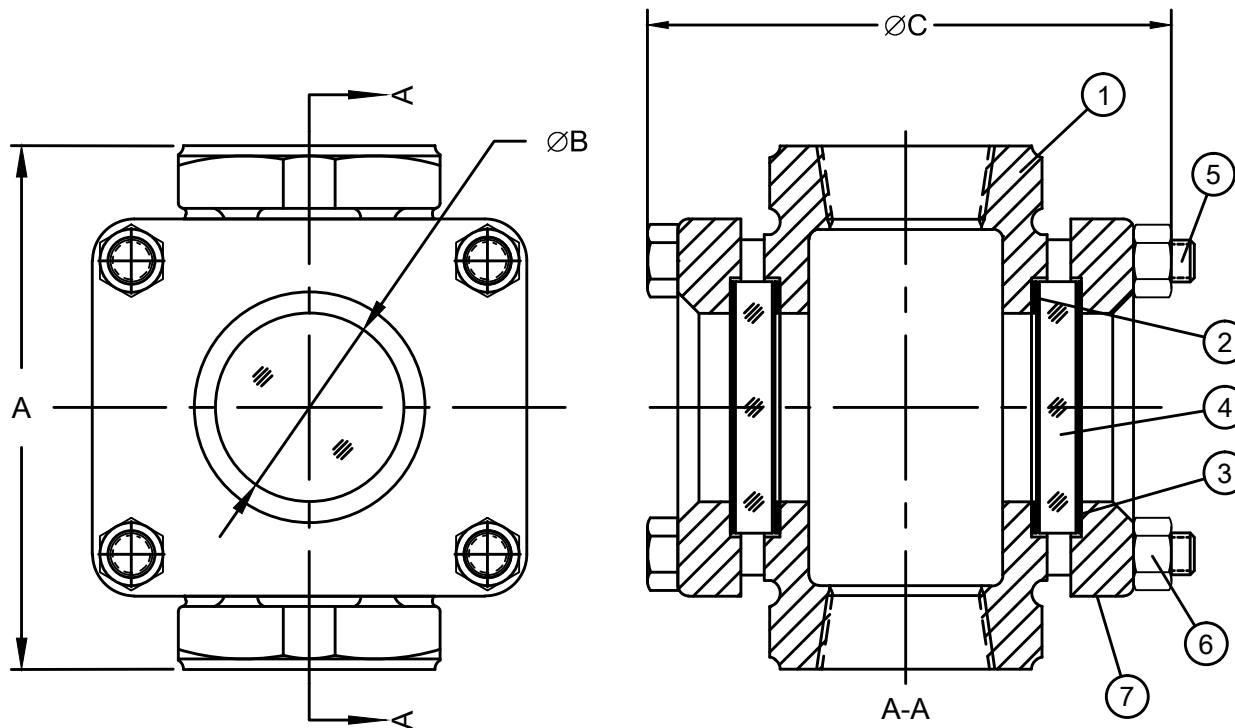

Notes:

- Units supplied with 1/2" female NPT pipe thread. Options include:
  - Socket Weld Ends
  - Butt-weld/Weld Neck Ends
  - Silbraze connections
- Standard body materials include:
  - A216 Grade WCB
  - A351 Grade CF8M
  - A240 T304/304L
  - A240 T316/316L
  - A516 Grade 70
  - B62 Bronze
  - Other materials available upon request.
- Standard Lens Material Tempered Borosilicate. Options include:
  - Fused Quartz
  - Non-Glass Plastics
  - Kel-F, Mica or PFA lens shields
- Standard lens retainer materials:
  - A216 Grade WCB
  - A351 Grade CF8M
  - A240 T304/304L
  - A240 T316/316L
  - A516 Grade 70
  - Other materials available upon request.
- Standard seal gasket choices include:
  - EPDM
  - Expanded PTFE
  - Silicone
  - others upon request.
- Standard fastener materials:
  - A193 B7 Bolt / A194 2H Nut
  - A193 B8 Bolt / A194 G8 Nut
  - Other alloys available upon request
- Perform ambient temp. hydrotest at 1.5x operating pressure.
- All units supplied with a 304 Stainless Steel Tag.
- Max Rating 150PSI/FV@500°F. Dependant on gasket and lens choice. Full ANSI Class Rating Available.

INDICATOR OPTIONS

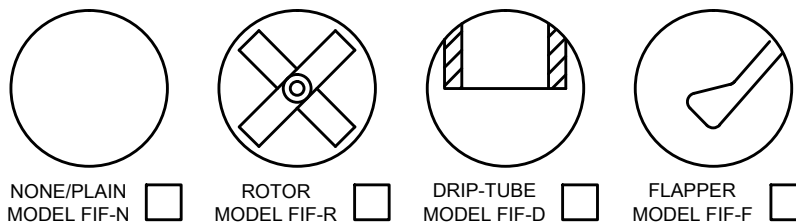

DIMENSIONS								
SIZE	DIM "A"		DIM "B"		DIM "C"		EST. WEIGHT	
	IN	mm	IN	mm	IN	mm	LBS	KGS
1/2"	3 3/4	95	1 1/8	29	3 1/16"	94	4	2

THIS DRAWING IS THE SOLE PROPERTY OF THE J.G. PAPAILIAS COMPANY, INC AND NEITHER THE DOCUMENT NOR THE INFORMATION CONTAINED HEREIN SHALL BE COPIED, REPRODUCED, DISCLOSED OR TRANSFERRED EXCEPT AS AUTHORIZED IN WRITING BY AN OFFICER OF THE J.G. PAPAILIAS CO., INC.

QTY	SYM	PART NUMBER	DESCRIPTION
1	7	XXXX-XXXX-XXXX	LENS RETAINER
4	6	XXXX-XXXX-XXXX	HEX NUT
4	5	XXXX-XXXX-XXXX	HEX BOLT
1	4	XXXX-XXXX-XXXX	LENS
1	3	XXXX-XXXX-XXXX	LENS CUSHION
1	2	XXXX-XXXX-XXXX	SEAL GASKET
1	1	XXXX-XXXX-XXXX	BODY

SIZE	CAGE CODE	DRAWING NUMBER	REV
A	1Z740	03A008	0
SCALE: NTS		EST. WEIGHT: SEE TABLE	SHEET: 1 OF 1

SERIES 1/2" FIS  
1/2" 150# THREADED SIGHT FLOW INDICATOR