

TRIAC

CJD136D

**DPAK (TO-252)
Plastic Package**

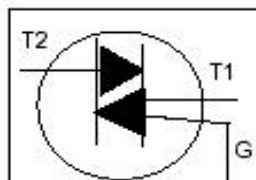
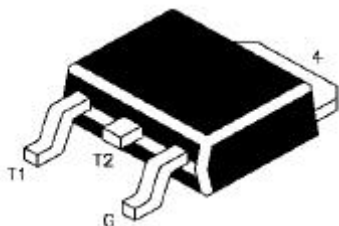

For use in high bidirectional transient and blocking voltage applications, and for high thermal cycling performance. Typical Applications include Motor Control, Industrial and Domestic Lighting, Heating and Static Switching.

ABSOLUTE MAXIMUM RATINGS

PARAMETER	SYMBOL	TEST CONDITION	VALUE	UNIT
Repetitive Peak Off State Voltage	$*V_{DRM}$		600	V
RMS on State Current	$I_T (RMS)$	full sine wave, $T_{mb} \leq 107^\circ C$	4.0	A
Non Repetitive Peak on State Current	I_{TSM}	full sine wave, $T_J = 25^\circ C$ prior to $t = 20ms$ $t = 16.7ms$	25 27	A A
I^2t for Fusing	I^2t	$t = 10ms$	3.1	A^2s
Repetitive Rate of Rise of on State Current After Triggering	di_T/dt	$I_{TM} = 6A, I_G = 0.2A, di_G/dt = 0.2A/\mu s$ T2+ G+ T2+ G- T2- G- T2- G+	50 50 50 10	A/ μs A/ μs A/ μs A/ μs
Peak Gate Current	I_{GM}		2.0	A
Peak Gate Voltage	V_{GM}		5.0	V
Peak Gate Power	P_{GM}		5.0	W
Average Gate Power	$P_{G(AV)}$	Over any 20ms period	0.5	W
Storage Temperature	T_{stg}		- 40 to +150	$^\circ C$
Operating Junction Temperature	T_j		125	$^\circ C$

*The rate of rise of current should not exceed 3A/ms

THERMAL RESISTANCE

Junction to Mounting Base	$R_{th(j-mb)}$	full cycle	3.0 max	K/W
		half cycle	3.7 max	K/W
Junction to Ambient (typical)	$R_{th(j-a)}$	in free air	60 typ	K/W

ELECTRICAL CHARACTERISTICS ($T_J = 25^\circ C$ unless specified otherwise)

PARAMETER	SYMBOL	TEST CONDITION	MIN	MAX	UNIT
Gate Trigger Current	I_{GT}	$V_D = 12V, I_T = 0.1A$			
		T2+ G+		5.0	mA
		T2+ G-		5.0	mA
		T2- G-		5.0	mA
		T2- G+		10	mA

MARKING

XY= Date Code

CJD136DRev100706E

CDIL
CJD136D
XY MX

TRIAC

CJD136D

DPAK (TO-252)
Plastic Package

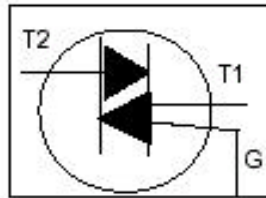
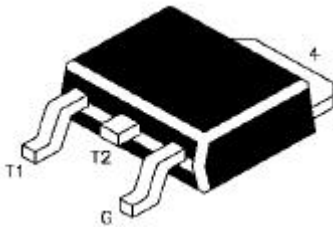

ELECTRICAL CHARACTERISTICS (T_J=25°C unless specified otherwise)

PARAMETER	SYMBOL	TEST CONDITION	MIN	MAX	UNIT
Latching Current	I _L	V _D =12V, I _{GT} =0.1A T2+ G+ T2+ G- T2- G- T2- G+		10 15 10 30	mA mA mA mA
Holding Current	I _H	V _D =12V, I _{GT} =0.1A		10	mA
On State Voltage	V _T	I _T =5A		1.7	V
Gate Trigger Voltage	V _{GT}	V _D =12V, I _T =0.1A V _D =400V, I _T =0.1A, T _J =125°C	0.25	1.5	V V
Off State Leakage Current	I _D	V _D =max, V _{DRM} =max, T _J =125°C		0.5	mA

DYNAMIC CHARACTERISTICS

PARAMETER	SYMBOL	TEST CONDITION	MIN	TYP	MAX	UNIT
Critical Rate of Rise of off State Voltage	d _{V_D} /dt	V _{DM} =67% V _{DRM} =max, T _J =125°C, exponential waveform, gate open circuit		5.0		V/μs
Gate Controlled turn on time	t _{gt}	I _{TM} =6A, V _D =V _{DRM} max, I _G =0.1A, di _G /dt=5A/μs		2.0		μs

CJD136DRev100706E

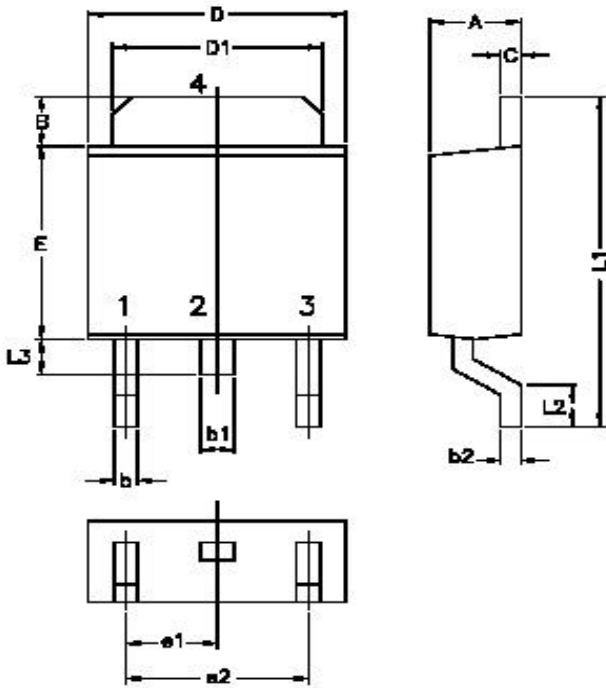

DIM	MIN.	MAX.
A	2.20	2.40
B	1.30	1.50
b	0.55	0.65
b1	0.75	0.85
b2	0.46	0.58
C	0.46	0.58
D	6.40	6.60
D1	5.20	5.40
E	5.40	5.60
e1	2.25	2.35
e2	4.50	4.70
L1	9.25	9.75
L2	0.5	—
L3	0.90	1.10

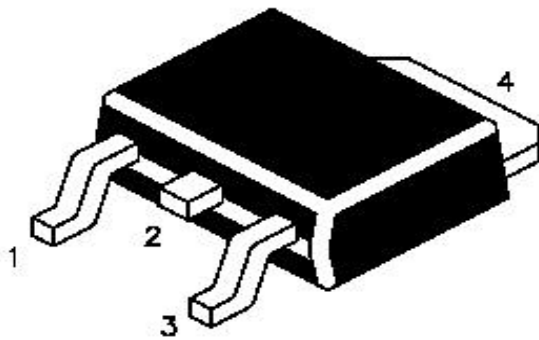

PIN CONFIGURATION

- 1. T1 MAIN TERMINAL 1
- 2. T2 MAIN TERMINAL 2
- 3. G GATE
- 4. FIN (T2)

DPAK PACKING TUBE

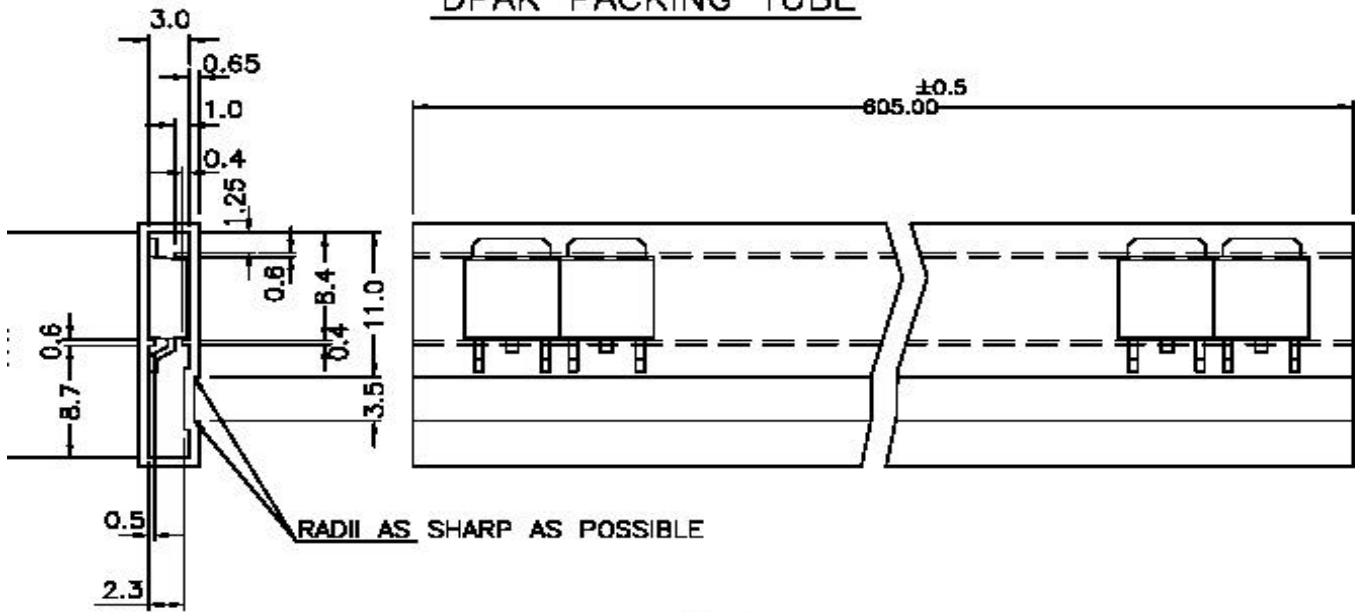

NOTE:-
80 Pcs/TUBE
ALL DIMENSIONS ARE IN mm

DPAK TAPE & REEL SPECIFICATION

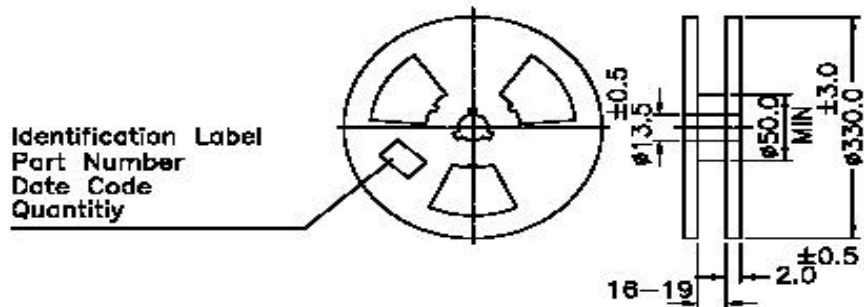

ALL DIMENSIONS ARE IN mm
REEL ϕ 330 mm (13")
No of Device 2500

TAPE & REEL

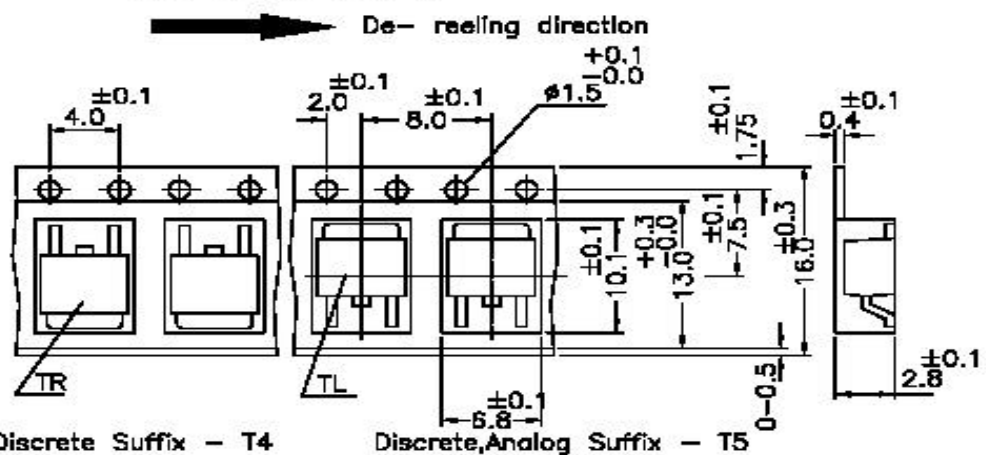

Notes:-
A maximum of three consecutive components may be missing. Provided this gap is followed by six consecutive components.

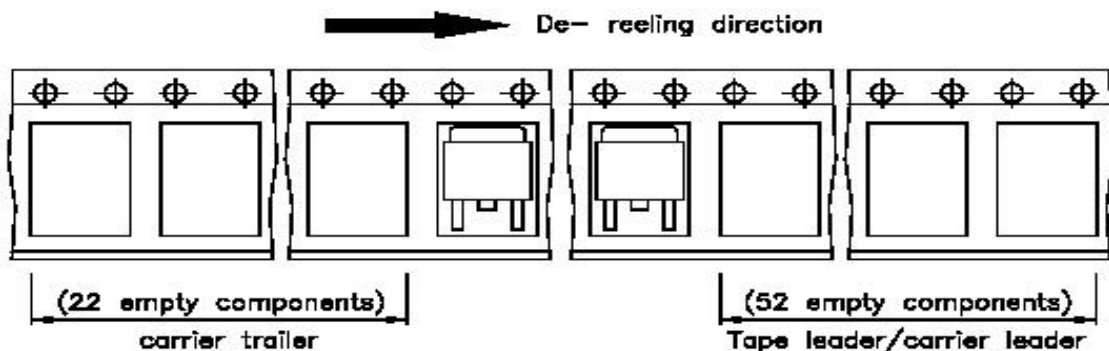

Component Disposal Instructions

1. CDIL Semiconductor Devices are RoHS compliant, customers are requested to please dispose as per prevailing Environmental Legislation of their Country.
2. In Europe, please dispose as per EU Directive 2002/96/EC on Waste Electrical and Electronic Equipment (WEEE).

Disclaimer

The product information and the selection guides facilitate selection of the CDIL's Semiconductor Device(s) best suited for application in your product(s) as per your requirement. It is recommended that you completely review our Data Sheet(s) so as to confirm that the Device(s) meet functionality parameters for your application. The information furnished in the Data Sheet and on the CDIL Web Site/CD are believed to be accurate and reliable. CDIL however, does not assume responsibility for inaccuracies or incomplete information. Furthermore, CDIL does not assume liability whatsoever, arising out of the application or use of any CDIL product; neither does it convey any license under its patent rights nor rights of others. These products are not designed for use in life saving/support appliances or systems. CDIL customers selling these products (either as individual Semiconductor Devices or incorporated in their end products), in any life saving/support appliances or systems or applications do so at their own risk and CDIL will not be responsible for any damages resulting from such sale(s).

CDIL strives for continuous improvement and reserves the right to change the specifications of its products without prior notice.



CDIL is a registered Trademark of
Continental Device India Limited

C-120 Naraina Industrial Area, New Delhi 110 028, India.

Telephone + 91-11-2579 6150,4141 1112 Fax + 91-11-2579 5290, 4141 1119

email@cdil.com www.cdilsemi.com