



● **FEATURES 特性**

1. Metallization on ferrite core results in excellent shock resistance and damage-free durability.
2. Closed magnetic circuit design reduces leakage flux and Electro Magnetic Interference (EMI).
3. Fe base metal material core provides large saturation current.
4. Automatic production ensures high quality and consistency.

● **APPLICATIONS 用途**

1. Protects AC side from the affects of switching regulators
2. Provides noise elimination and immunity for TVs,TVRs/VCRs, audio equipmens,etc

● **PART NUMBERING SYSTEM 品名系统**

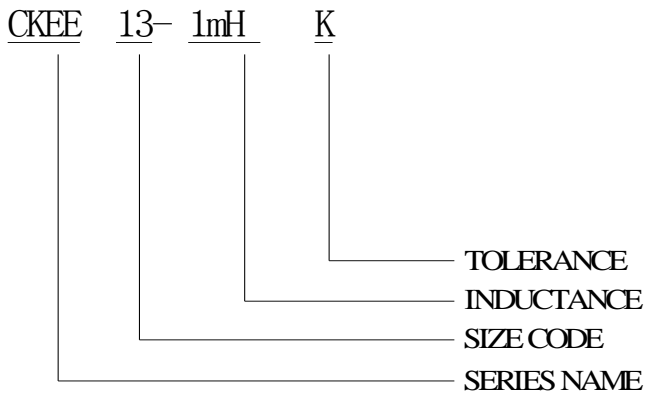

● **SHAPES AND DIMENSIONS 外形尺寸 (Unit:mm)**

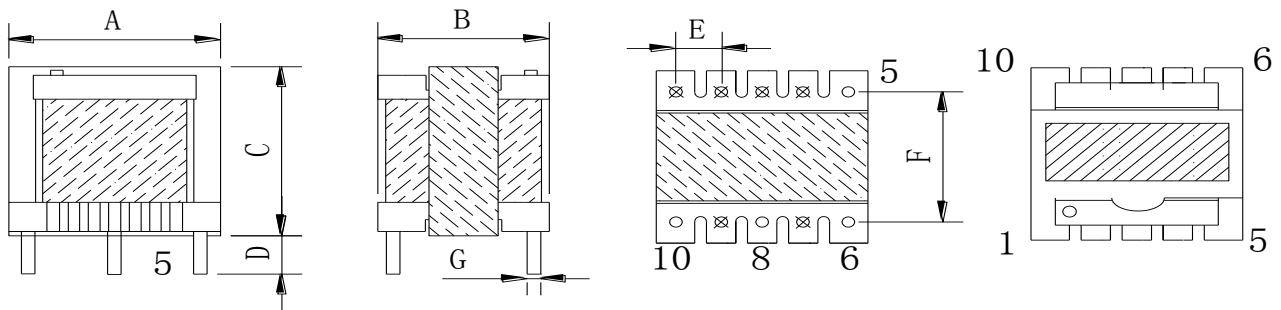

TYPE(型号)	A	B	C	D	E	F	G
CKEE13	15.5Max	14.5Max	15.0Max	4.0±0.5	2.5±0.5	8.5±0.5	0.6±0.1
CKEE16	18.0Max	14.5Max	17.0Max	4.0±0.5	3.25±0.5	10.5±0.5	0.6±0.1
CKEE16	19.0Max	19.5Max	17.5Max	4.0±0.5	3.2±0.5	15.5±0.5	0.7±0.1
CKEE19	20.5Max	17.5Max	20.0Max	4.0±0.5	3.9±0.5	13±0.5	0.7±0.1
CKEE22	23.5Max	17.5Max	20.0Max	4.0±0.5	4±0.5	10.3±0.5	0.8±0.1
CKEE25	26.5Max	18.5Max	23.5Max	4.0±0.5	5±0.5	12.5±0.5	0.8±0.1

产品中心 \ 贴片功率电感

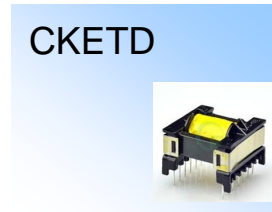
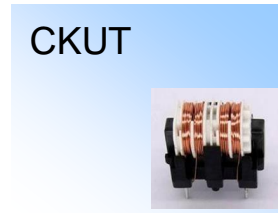
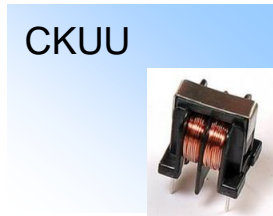

● CKUU

产品照片	尺寸(LxWxH)	电感	额定电流	系列名称	目录
	17.0*17.0*12.0mm	0.5mH ~ 50mH	0.02 ~ 1.0A	CKUU9.8	CKUU
	19.5x22.5x17.5mm	0.6mH ~ 80mH	0.02 ~ 2.0A	CKUU10.5	
	23.5*29.5*20.0mm	1.5mH ~ 100mH	0.02 ~ 3.0A	CKUU16	

● CKUT

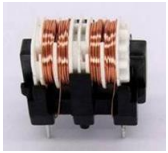
	22.5*17.5*23.0mm	0.5mH ~ 20mH	0.3 ~ 3.0A	CKUT20	CKUT
	23.0*23.0*16.0mm	0.5mH ~ 10mH	0.4 ~ 3.0A	CKET20	
	25.5*25.5*22.0mm	0.5mH ~ 30mH	0.5 ~ 4.0A	CKET24	

● CKEE

产品照片	尺寸(LxWxH)	电感	额定电流	系列名称	目录
	7.8*7.8*8.2mm	0.2mH ~ 5mH	0.1 ~ 0.6A	CKEE6.5	CKEE
	10.0*10.0*10.0mm	0.3mH ~ 20mH	0.2 ~ 1.0A	CKEE8.3	
	12.5*12.5*13.0mm	0.5mH ~ 50mH	0.2 ~ 1.5A	CKEE10	

● CKEE-1

产品照片	尺寸(LxWxH)	电感	额定电流	系列名称	目录
	15.5*14.5*15.0mm	0.5mH ~ 15mH	0.5 ~ 2.0A	CKEE13	CKEE-1
	18.0*14.5*17.0mm	0.5mH ~ 15mH	0.5 ~ 2.0A	CKEE16	
	19.0*19.5*17.5mm	0.5mH ~ 20mH	0.5 ~ 2.5A	CKEE16	
	20.5*17.5*20.0mm	0.5mH ~ 20mH	0.5 ~ 3.0A	CKEE19	
	23.5*17.5*20.0mm	0.5mH ~ 25mH	0.5~ 3.5A	CKEE22	
	26.5*18.5*23.5mm	0.5mH ~ 30mH	0.5 ~ 4.0A	CKEE25	

● CKEPC

产品照片	尺寸(LxWxH)	电感	额定电流	系列名称	目录
	15.0*15.0*10.0mm	0.5mH ~ 15mH	0.5 ~ 2.0A	CKEPC13	CKEPC
	19.0*17.0*13.0mm	0.5mH ~ 20mH	0.5 ~ 2.5A	CKEPC17	
	21.0*21.0*13.5mm	0.5mH ~ 20mH	0.5~ 3.0A	CKEPC19	
	27.0*27.0*17.0mm	0.5mH ~ 30mH	0.5 ~ 4.0A	CKEPC25	

● CKEFD

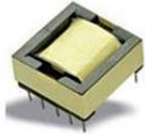
产品照片	尺寸(LxWxH)	电感	额定电流	系列名称	目录
	17.0*18.0*9.5mm	0.5mH ~ 10mH	0.5 ~ 2.5A	CKEFD15	CKEFD
	22.0*23.0*11.0mm	0.5mH ~ 15mH	0.5~ 3.0A	CKEFD20	
	27.0*28.0*13.0mm	0.5mH ~ 20mH	0.5~ 3.0A	CKEFD25	
	32.0*33.0*14.0mm	0.5mH ~ 30mH	0.5 ~ 3.5A	CKEFD30	

● CKETD

产品照片	尺寸(LxWxH)	电感	额定电流	系列名称	目录
	36.0*36.0*25.5mm	0.5mH ~ 20mH	0.6 ~ 2.5A	CKETD29	CKETD
	41.5*41.5*32.0mm	0.5mH ~ 30mH	0.5 ~ 4.0A	CKETD34	
	46.0*46.0*37.5mm	0.5mH ~ 35mH	0.5 ~ 5.5A	CKETD39	
	55.0*58.5*42.5mm	0.5mH ~ 40mH	0.5 ~ 6.5A	CKETD49	

● CKER

产品照片	尺寸(LxWxH)	电感	额定电流	系列名称	目录
	32.0*40.0*27.5mm	0.5mH ~ 20mH	0.5 ~ 2.5A	CKER28	CKER
	41.0*45.0*30.0mm	0.5mH ~ 30mH	0.5 ~ 3.0A	CKER35	
	42.0*45.0*32.0mm	0.5mH ~ 40mH	0.5 ~ 4.0A	CKER40	
	44.0*46.0*37.0mm	0.5mH ~ 45mH	0.5 ~ 5.0A	CKER42	