

CET-TP32 SERIES

High Frequency 1.2kWatts
Planar Transformers

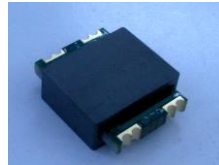

FEATURES

- Power Rating Up to 1200 Watts
- High Efficiency of Over 99.0%
- High Frequency 100 kHz – 500 kHz
- Footprint 52.0 mm X 33.0 mm
- Lower Profile of 12.3 mm Max
- High Isolation (operational) 5000 Vdc
- Operating Temperature -40° C to +125° C

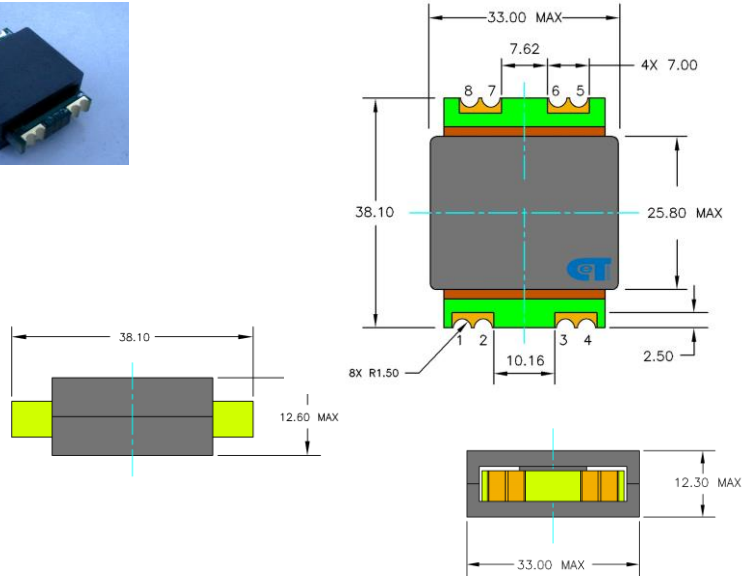

ELECTRICAL SPECIFICATIONS											
Part Number	Primary ¹ Inductance (uH Min)	Leakage ² Inductance (uH Max)	DC Resistance (m Ω Max)				Turns Ratio		Pri/Sec Hi-Pot	Figure	M. Height
			Primary			Secondary	Primary	Secondary			
			A	B	AUX.						
TP32D0412	9.0 ± 10%	0.06	2.60			25.0	4T	12T	1500Vdc	1	12.30 MAX.
TP32D0404	48.00	0.60	4.00		4T	2.00	4T	4T	2000Vdc	2	
TP32D1605	760.0	0.30	60.0		16T	3.30	16T	5T	5000Vdc	3	
TP32D2402	1700	0.40	90.0			0.36	24T	2T	5000Vdc	4	

- 1.The inductance is measured in primary windings.
- 2.The leakage inductance is measured in primary windings with secondary windings shorted.
- 3.All specifications typical at T_A=25° C.

APPLICATION OF CONFIGURATION					
Part Number	Vinput	Vout & Iout	Part Number	Vinput	Vout & Iout
TP32D0412	6 – 32 Vdc	180Vdc@5.0A	TP32D1605	180 – 350 Vdc	25.0Vdc@20.0A
TP32D0404	36 – 75 Vdc	15.0Vdc@32.0A	TP32D2402	380 – 410 Vdc	12.0Vdc@100.0A

CET-TP32 SERIES

High Frequency 1.2kWatts
Planar Transformers

SCHEMATICS

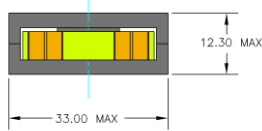
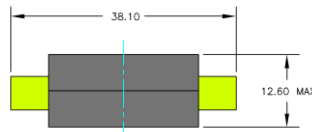
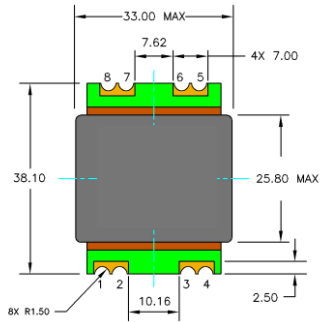
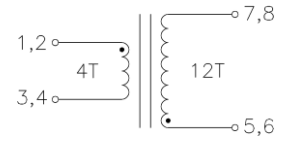

FIGURE 1



TP32D0412
(Flyback)

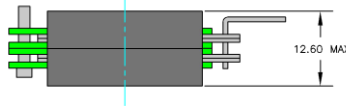
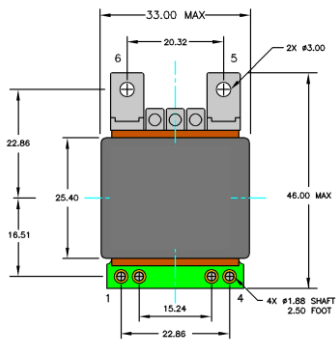
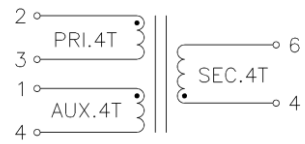

FIGURE 2



TP32D0404
(Forward)

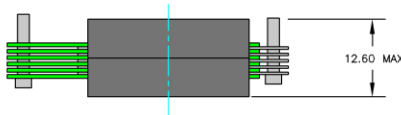
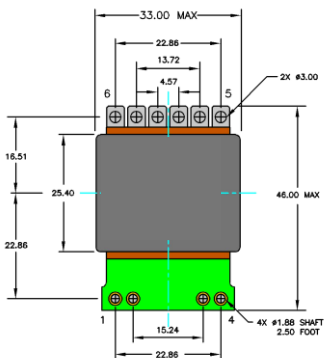
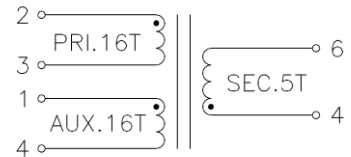

FIGURE 3



TP32D1605
(Forward)

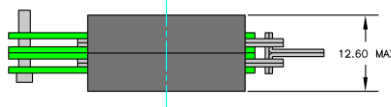
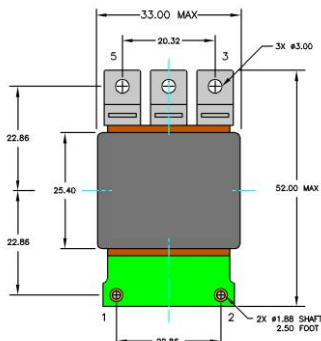
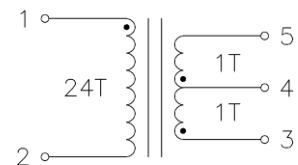

FIGURE 4



TP32D2402
(Full Bridge)