

Data Center Applications  
Standards Reference Guide  
Networking and Storage

# Contents

<b>Scope</b>	<b>3</b>
<b>Introduction</b>	<b>3</b>
<b>Data Center cabling standard ISO/IEC 24764</b>	<b>4</b>
<b>Ethernet (IEEE 802.3)</b>	<b>6</b>
<b>Proprietary 40 Gb/s BiDi</b>	<b>9</b>
<b>Fibre Channel applications (INCITS, T11)</b>	<b>10</b>
<b>InfiniBand</b>	<b>13</b>

# Scope

This technical paper provides an overview of the most prevalent networking and storage applications in modern data centers. Additionally, it offers information about the different structured cabling systems capable of running these applications and also functions as an application reference book for network cabling designers in data centers.

## 1. Introduction

The definition of the most dominant networking and storage applications in data centers used in this technical paper is derived from the following graphic (source: Cisco):

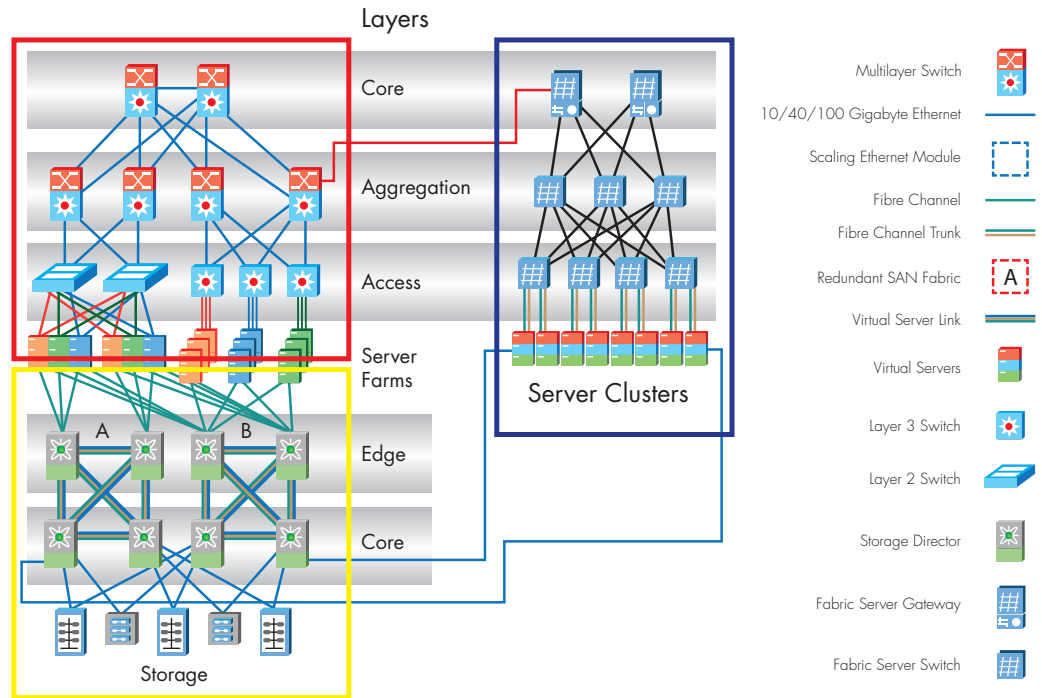

**Figure 1: Data Center functional elements and applications**

The applications can be grouped into:

Application	Functional
Ethernet	Networking area (red marked)
Fibre Channel	Storage area (yellow marked)
InfiniBand	High-performance server cluster and storage (blue marked)

**Note:** IP convergence is becoming more and more popular in Data Centers, resulting in deployment of Fibre Channel over Ethernet (FCoE) and InfiniBand over Ethernet (IoE) applications. Although they are not listed here, they will be covered in later chapters.

## 2. Data Center cabling standard ISO/IEC 24764

This standard is being incorporated into the ISO/IEC 11801 series and will be renamed ISO/IEC 11801-5. Together with the ISO/IEC 11801 (ed. 2.2—Generic Cabling for Customer Premises) it defines the cabling systems for copper and fiber applications in data centers. These standards are used as references for linking the mentioned data center applications to standards-compliant cabling systems.

### 2.1 Copper cabling systems

ISO/IEC 11801 ed. 2.2 defines the following performance classifications for balanced cabling:

Class	Specified up to
Class D	100 MHz
Class E	250 MHz
Class E <sub>A</sub>	500 MHz
Class F	600 MHz
Class F <sub>A</sub>	1000 MHz

**Table 1: Performance classifications for balanced cabling**

The following copper connector definitions have been made for the equipment outlet (EO)

Category 6A unshielded	IEC 60603-7-41
Category 6A shielded	IEC 60603-7-51
Category 7 shielded	IEC 60603-7-7
Category 7A shielded	IEC 60603-7-71
Category 7A shielded	IEC 61076-3-104

**Table 2: Connecting hardware of the type used at the EO**

## 2.2. Fiber-optic cabling systems

For multimode fiber-optic cabling systems, the following cabled fiber definitions are used:

		Minimum modal bandwidth MHz*km		
		Overfilled launch bandwidth		Effective modal bandwidth
Wavelength		850 nm	1300 nm	850 nm
Category	Nominal core diameter $\mu\text{m}$			
OM3	50	1500	500	2000
OM4	50	3500	500	4700

**Table 3: Fiber types and bandwidths**

**Note:** Modal bandwidth requirements apply to the optical fiber used to produce the relevant cabled optical fiber category and are assured by the parameters and test methods specified in IEC 60793-2-10.

	Cabled optical fiber attenuation (maximum) dB/km				
	OM3 and OM4 multimode		OS2 singlemode		
Wavelength	850 nm	1300 nm	1310 nm	1383 nm	1550 nm
Attenuation	3.0	1.5	0.4	0.4	0.4

**Table 4: Performance definitions for cable optical fiber**

### The following fiber connector definitions have been made for the equipment outlet (EO):

- For the termination of one or two singlemode optical fibers, the interface shall be IEC 61754-20 (the LC interface).
- For the termination of one or two multimode optical fibers, the interface shall be IEC 61754-20 (the LC interface).
- For the termination of more than two optical fibers, the interface shall be IEC 61754-7 (the MPO interface).

## 2.3. Minimum requirements for data center cabling

To ensure a future-proof selection of the data center cabling systems, ISO/IEC 24764 specifies minimum cabling performance requirements for data centers as follows:

### 2.3.1 Balanced cabling

The main distribution cabling shall be designed to provide a minimum of Class E<sub>A</sub> channel performance as specified in ISO/IEC 11801.

### 2.3.2 Optical fiber cabling

Where multimode optical fiber is used, the main distribution and zone distribution cabling shall provide channel performance as specified in ISO/IEC 11801 using a minimum of OM3 multimode fiber.

### 2.3.3 Comparison with ANSI/TIA942-A

The ANSI/TIA 942-A Telecommunications Infrastructure Standard for Data Centers has very similar guidelines regarding minimum performance levels for cabling and connectors

Copper	Category 6A
Multimode fiber	Minimum OM3, recommended OM4
Fiber connector	LC (1-2 fibers) MPO (>2 fibers)

**Table 5: ANSI/TIA 942-A requirements**

## 3. Ethernet (IEEE 802.3)

Ethernet applications according to IEEE 802.3 are dominating the networking area in today's data centers. The server farms in the equipment distribution areas (access) typically use 10-gigabit Ethernet today, with higher speeds coming in the near future. In the aggregation and core areas, 40/100 gigabit Ethernet using fiber-optic cabling is the choice of cabling designers globally. Projects are currently underway in IEEE 802.3 for 400-gigabit Ethernet applications.

As mentioned in 2.3.2, the minimum requirement defined by the data center cabling standard for cabled optical fiber in data centers is OM3. Other fiber types are listed for reference only.

### 3.2. Gigabit Ethernet over copper

1000BASE-T (also known as IEEE 802.3ab) is a standard for gigabit Ethernet over copper wiring.

Each 1000BASE-T network segment can be a maximum length of 100 meters and must offer a Class D channel performance as a minimum. 1000BASE-T requires all four pairs for transmission.

As mentioned in 2.3.1, the minimum performance class requirement defined by the data center cabling standard for copper cabling systems is Class E<sub>A</sub>, which is backward compatible to support Class D performance.

### 3.3. 10 Gigabit Ethernet

#### 3.3.1. 10 Gigabit Ethernet over fiber

In 2002, 10GBE over fiber has been specified by IEEE 802.3ae with both WAN and LAN application focus. Because of the severe link length limitations of this application when using traditional 50/125  $\mu\text{m}$  (OM2) and 62.5/125  $\mu\text{m}$  (OM1) fibers, the international cabling standards had to define a new laser-optimized 50/125  $\mu\text{m}$  fiber (OM3) featuring a much more precise fiber core index profile. The much higher effective modal bandwidth of that fiber allows longer link lengths meeting building and data center requirements.

There are three 10GBE multimode fiber applications used in data centers: 10GBASE-LX4, 10GBASE-IRM and 10GBASE-SR. All are dual-fiber applications for transmit and receive.

#### 3.3.2. 10 Gigabit Ethernet over copper

10GBE over copper (10GBASE-T), defined as IEEE 802.3an, was similarly challenging for copper cabling systems as IEEE 802.3ae has been for fiber-optic systems. Because of the link length limitations for Class E/Category 6 UTP systems to 37 meters, the cabling standards had

to define the new cabling performance Class E<sub>A</sub>, which is the minimum cabling requirement in data center cabling. Class E<sub>A</sub> cabling supports 100-meter channels for 10GBASE-T.

**Note:** OM1/OM2/OM3 = 200 MHz-km/500 MHz-km/2,000 MHz-km bandwidth, respectively OS1 = 9/125 singlemode; OS2 = 9/125 low water peak singlemode

Ethernet 10GBase physical layer specifications					
Type	PMD	Technology	Connector	Media	Reach (m)
Copper	10GBASE-T	Twisted Pair	RJ45	Category 6 UTP	37
				Category 6 STP/Category 6A UTP/STP	100
Fiber	10GBASE-SR	850 nm VCSEL, serial	Duplex LC and SC	OM1/OM2/OM3/OM4 MMF	33/82/300/550
	10GBASE-LRM	1310 nm LD, serial		OM1/OM2/OM3 MMF	220/220/300
	10GBASE-LX4	1310 nm LD, WDM		OM1/OM2/OM3 MMF	300
				OS1 and OS2 SMF	10,000
	10GBASE-IR	1310 nm LD, serial		OS1 and OS2 SMF	10,000
	10GBASE-ER	1550 nm LD, serial			40,000

**Table 6: Application vs. media vs. link length for 10-gigabit Ethernet**

As mentioned in 2.3.2, the minimum requirement defined by the data center cabling standard for cabled optical fiber in data centers is OM3. Other fiber types are listed for reference only.

### 3.4. 40- and 100-Gigabit Ethernet

IEEE defines 40- and 100-gigabit Ethernet in two different standards.

IEEE 802.3ba defines both data rates (40GBE and 100GBE) simultaneously. While the singlemode versions operate on two fibers using an LC-Duplex connector, the multimode versions for both speeds are based on multiple (four or ten) data streams of 10 Gbit/s Ethernet in full duplex operation. This requires utilizing eight fibers (40GBASE-SR4) or 20 fibers (100GBASE-SR10) terminated in the multifiber connector MPO.

IEEE 802.3bm was published in March 2015 and defines the second generation of 100 GbE using four full-duplex data streams of 25 Gbit/s. This results in using eight fibers terminated in the multifiber connector MPO.

The following table gives a complete overview about all 40/100 GBE applications.

	Channel length 40GBASE-SR4	Channel length 100GBASE-SR10	Channel length 100GBASE-SR4	Channel length 40GBASE-LR4	Channel length 100GBASE-LR4	Channel length 100GBASE-ER4
OM3, 50/125 μm	100 m	100 m	70 m	N/A	N/A	N/A
OM4, 50/125 μm	150 m*	150 m*	100 m*	N/A	N/A	N/A
OS1/OS2 9/12 μm	N/A	N/A	N/A	10 km	10 km	40 km

\* special link budget applies—see Section 3.5

**Table 7: Channel length definitions for 40/100GBE depending on application and fiber type**

### 3.4.1. 40GBASE-SR4 (40GBE) and 100GBASE-SR4 (100GBE)

The following graphics illustrate the concept of the parallel data transmission on multifiber links using the MPO connector and the respective pinout for 40GBASE-SR4 (40GBE) and 100GBASE-SR4 (100GBE)



**Figure 2: 40GBASE-SR4 (40GBE) and 100GBASE-SR4 (100GBE) full duplex operation on eight fibers**

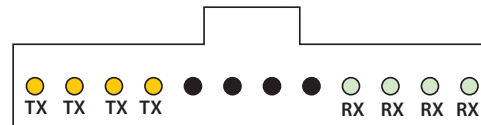

**Figure 3: MPO connector pinout for 40GBASE-SR4 (40GBE) and 100GBASE-SR4 (100GBE)**

### 3.4.2. 100GBASE-SR10 (100GBE)

The following graphics illustrate the concept of the parallel data transmission on multifiber links using the MPO connector and the respective pinout for 100GBASE-SR10

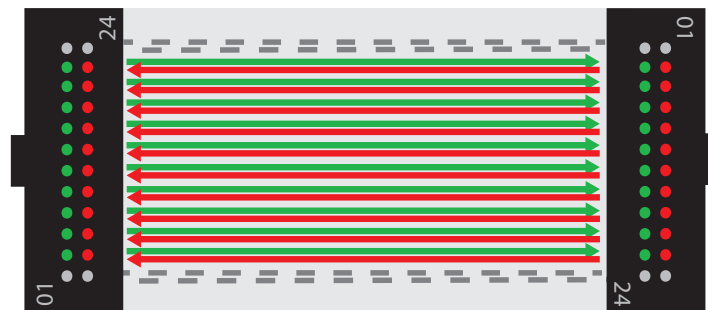

**Figure 4: 100GBASE-SR10 full duplex operation on 20 fibers**

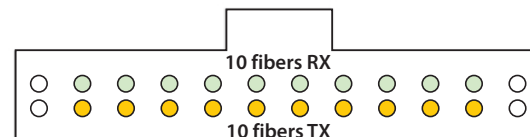

**Figure 5: MPO connector pinout for 100GBASE-SR10**



### 3.5. Channel power budgets for Ethernet applications

In addition to the link length definitions, the power budget definition for cabling systems is another critical parameter to monitor when deploying FO applications. The following table outlines the cabling system power budget for the above-mentioned Ethernet applications.

Network application	Maximum channel insertion loss (dB)		
	Multimode		Singlemode
	850 nm	1300 nm	1310 nm
IEEE 802.3: 10BASE-FL and FB	12.5 (6.8)**	–	–
IEEE 802.3: 1000BASE-SX	2.6 (3.56)**	–	–
IEEE 802.3: 1000BASE-LX	–	2.35	4.56
ISO/IEC 8802-3: 100BASE-FX	–	11.0 (6.0)	–
IEEE 802.3: 10GBASE-LX4	–	2.00	6.20
IEEE 802.3: 10GBASE-SR/SW	1.60 (62.5)/1.80 (OM2 50)/2.60 (OM3)		–
IEEE 802.3: 10GBASE-LR/LW	–	–	6.20
IEEE 802.3: 40GBASE-LR4	–	–	6.70
IEEE 802.3: 100GBASE-LR4	–	–	6.3
IEEE 802.3: 100GBASE-ER4	–	–	18.0
IEEE 802.3: 40GBASE-SR4	1.9 (100m OM3)/1.5 (150m OM4)*	–	–
IEEE 802.3: 100GBASE-SR10	1.9 (100m OM3)/1.5 (150m OM4)*	–	–
IEEE 802.3: 100GBASE-SR4	1.9 (70m OM3)/1.9 (100m OM4)	–	–

\* While all listed applications allocate 1.5 dB insertion loss for splices and connections within a cabling channel, 40 and 100 GBE on OM4 requires a lower insertion loss of 1 dB for all splices and connections in a channel, requiring an engineered link using a FO cabling system with highest performing connector technology.

\*\* Values shown are for 62.5/125  $\mu\text{m}$ . Values in parentheses represent 50/125  $\mu\text{m}$ .

**Table 8: Channel budget for Ethernet applications depending on application and fiber type**

## 4. Proprietary 40 Gb/s BiDi

Some equipment vendors have developed a proprietary 40 Gb/s technology using two fibers. This technology is not compatible with the current IEEE standards for 40 Gb/s Ethernet. The QSFP 40 Gb/s BiDi transceiver uses two 20 Gb/s channels, each transmitted and received simultaneously on two wavelengths. The result is an aggregated 40 Gb/s link over two fibers, connected with an LC-Duplex connector. The following graphic shows the technology.

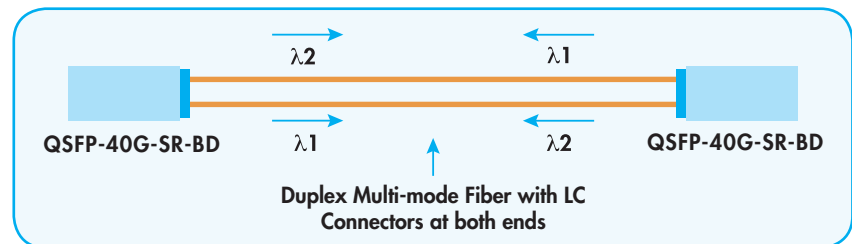

**Figure 6: 40 Gb/s BiDi technology**

The channel loss budget for 40 Gb/s BiDi is 2 dB. This results in the following cabling specifications:

Wavelength	Cable type	Core size	Modal bandwidth (MHz x km)	Cable distance
850 to 900 nm	MMF	50.0 microns	500 (OM2)	30m
			2000 (OM3)	100m*
			4700 (OM4)	125m**

\* Connector loss budget for OM3 fiber is 1.5 dB

\*\* 125 meters over OM4 fiber is with an engineered link with 1 dB budget for connector loss

**Table 9: Channel lengths for 40 Gb/s BiDi**

In addition to the BiDi application, other nonstandard implementations—such as 40GBASE-eSR4—have been implemented. 40GBASE-eSR4 transceivers provide an extended range performance compared with standard 40GBASE-SR4 transceivers.

## 5. Fibre Channel applications (INCITS, T11)

Fibre Channel (FC) is a gigabit-speed network technology primarily used for storage networking. Fibre Channel is standardized in the T11 Technical Committee of the InterNational Committee for Information Technology Standards (INCITS), an American National Standards Institute (ANSI)-accredited standards committee. It started primarily in the supercomputer field, but has become the standard connection type for storage area networks (SAN) in data centers

The following shows the FCIA (Fibre Channel Industry Association) technology roadmap for this application.

### 5.1 Fibre Channel—Overview

Fibre channel speed roadmap—(FC V20)				
Product naming	Throughput (Mbps)	Line rate (GBaud)	T11 spec technically completed (years)‡	Market availability (years)‡
1GFC	200	1.0625	1996	1997
2GFC	400	2.125	2000	2001
4GFC	800	4.25	2003	2005
8GFC	1600	8.5	2006	2008
16GFC	3200	14.025	2009	2011
32GFC	6400	28.05	2013	2016
128GFC	25600	4X28.05	2014	2016
64GFC	12800	56.1	2017	2019
256GFC	51200	4X56.1	2017	2019
128GFC	25600	TBD	2020	Market Demand
256GFC	51200	TBD	2023	Market Demand
512GFC	102400	TBD	2026	Market Demand
1TFC	204800	TBD	2029	Market Demand

“FC” used throughout all applications for Fibre Channel infrastructure and devices, including edge and ISL interconnects. Each speed maintains backward compatibility at least two previous generations (e.g., 8GFC backward compatible to 4GFC and 2GFC)

\* Line rate: All “...GFC” speeds listed above are single-lane serial stream I/Os. All “...GFCp” speeds listed above are multi-lane I/Os

‡ Dates: Future dates estimated

**Table 10: Fibre Channel speed roadmap (source: Fibre Channel Industry Association)**

## 5.2. Fibre Channel over fiber

Fibre Channel is primarily deployed over fiber-optic cabling systems.

Channel length is a function of fiber type and specific Fibre Channel application. The following table provides a complete overview.

Channel lengths / m						
Fiber type	1 Gbps FC	2 Gbps FC	4 Gbps FC	8 Gbps FC	16 Gbps FC	32 Gbps FC
OM3, 50/125 $\mu\text{m}$	860	500	380	150	100	70
OM4, 50/125 $\mu\text{m}$	min. 860	min. 500	400	190	125	100
OS1/OS2, 9/125 $\mu\text{m}$	10000	10000	10000	10000	10000	10000

**Note:** Fibre Channel specifies these lengths assuming an insertion loss of 1.5 dB (MM) and 2 dB (SM) for all connections and splices in the channel. See 5.5 for deviating multimode channel lengths depending on different connection/splice losses.

**Table 11: Channel length definitions for Fibre Channel over fiber depending on application and fiber type**

## 5.3. Fibre Channel over Ethernet (FCoE)

Fibre Channel over Ethernet (FCoE) is an extension of the Fibre Channel storage protocol that uses Ethernet as its physical transmission technology. FCoE combines Fibre Channel and Ethernet to provide end users with a “converged” network option for storage SAN connectivity and LAN traffic. Combined with enhancements to Ethernet, FCoE allows data centers to consolidate their I/O and network infrastructures into a converged network. FCoE is simply a transmission method in which the Fibre Channel frame is encapsulated into an Ethernet frame at the server. The server encapsulates Fibre Channel frames into Ethernet frames before sending them over the LAN, and de-encapsulates them when FCoE frames are received. Server input/output (I/O) consolidation combines the network interface card (NIC) and host bus adapter (HBA) cards into a single converged network adapter (CNA). Fibre Channel encapsulation requires use of 10-gigabit Ethernet transmission electronics.

Fibre Channel speed roadmap (V20)				
Fibre Channel speed roadmap—FCoE				
Product naming	Throughput (Mbps)	Equivalent line rate (Gbaud)	Spec technically completed (year)*	Market availability (year)
10GFCoE	2400	10.52	2002	2009
40GFCoE	9600	41.25	2010	2013
100GFCoE	24000	10X10.3125	2010	Market Demand
100GFCoE	24000	4X25.78125	2015	Market Demand
400GFCoE	96000	8X51.5625	2017	Market Demand

**Table 12: Fibre Channel speed roadmap**

FCoE tunnels FC through Ethernet. For compatibility, all FCFs and CNAs are expected to use SFP+ or standard RJ45 connectivity, allowing the use of all standard and nonstandard optical technologies—and, additionally, allowing the use of BASE-T connections as well as direct connect cables using the SFP+ electrical interface. FCoE ports otherwise follow Ethernet standards and compatibility guidelines.

## 5.4. Channel power budgets for FC applications

Channel Budget / dB						
Fiber type	1 Gbps FC	2 Gbps FC	4 Gbps FC	8 Gbps FC	16 Gbps FC	32 Gbps FC
OM3, 50/125 $\mu\text{m}$	4.62	3.31	2.88	2.04	1.86	1.87
OM4, 50/125 $\mu\text{m}$	4.62	3.31	2.95	2.19	1.95	1.87
OS1/OS2, 9/125 $\mu\text{m}$	7.8	7.8	7.8	6.4	6.4	6.21

**Table 13: Channel budget for Fibre Channel over fiber depending on application and fiber type**

The multimode channel lengths given in 5.2 are based on an allocation of 1.5 dB insertion loss of all connectors and splices within a channel. However, a connector/splice loss in a channel deviating from the 1.5 dB results in different maximum channel lengths. The following table gives an overview.

4G FC 400-SN max operating distance and loss budget for different connection losses					
Distance (m) / Loss Budget (dB)					
Fiber Type	Connection Loss				
	3.0 dB	2.4 dB	2.0 dB	1.5 dB	1.0 dB
M5F (OM4)	200 / 3.72	300 / 3.49	370 / 3.34	400 / 2.95	450 / 2.63
M5E (OM3)	150 / 3.54	290 / 3.45	320 / 3.16	380 / 2.88	400 / 2.45

8G FC 800-SN max operating distance and loss budget for different connection losses					
Distance (m) / Loss Budget (dB)					
Fiber Type	Connection Loss				
	3.0 dB	2.4 dB	2.0 dB	1.5 dB	1.0 dB
M5F (OM4)	50 / 3.18	120 / 2.83	160 / 2.58	190 / 2.19	220 / 1.80
M5E (OM3)	35 / 3.13	110 / 2.80	125 / 2.45	150 / 2.04	180 / 1.65

16G FC 1600-SN max operating distance and loss budget for different connection losses					
Distance (m) / Loss Budget (dB)					
Fiber Type	Connection Loss				
	3.0 dB	2.4 dB	2.0 dB	1.5 dB	1.0 dB
M5F (OM4)	N/A	50 / 2.58	100 / 2.36	125 / 1.95	150 / 1.54
M5E (OM3)	N/A	40 / 2.54	75 / 2.27	100 / 1.86	120 / 1.43

32G FC 3200-SN max operating distance and loss budget for different connection losses					
Distance (m) / Loss Budget (dB)					
Fiber Type	Connection Loss				
	3.0 dB	2.4 dB	2.0 dB	1.5 dB	1.0 dB
M5F (OM4)	20 / 3.04	65 / 2.64	80 / 2.36	100 / 1.86	110 / 1.48
M5E (OM3)	15 / 3.03	45 / 2.64	60 / 2.24	70 / 1.87	80 / 1.41

**Table 14: Channel length for Fibre Channel over fiber depending on application, fiber type and connection/splice loss**

## 6. InfiniBand

InfiniBand is a technology that was developed to address the performance problems associated with data movement between computer input/output (I/O) devices and associated protocol stack processing. The InfiniBand architecture (IBA) is an industry-standard architecture for server I/O and interserver communication. It was developed by the InfiniBandSM Trade Association (IBTA) to provide the levels of reliability, availability, performance, and scalability necessary for present and future server systems—levels significantly better than

can be achieved with bus-oriented I/O structures. Although InfiniBand was developed to address I/O performance, InfiniBand is widely deployed within high-performance compute (HPC) clusters and storage networks due to the high bandwidth and low latency transport characteristics it offers.

The following graph shows the InfiniBand Roadmap taken from the home page of the InfiniBand Trade Association ([www.infinibandta.org](http://www.infinibandta.org)).

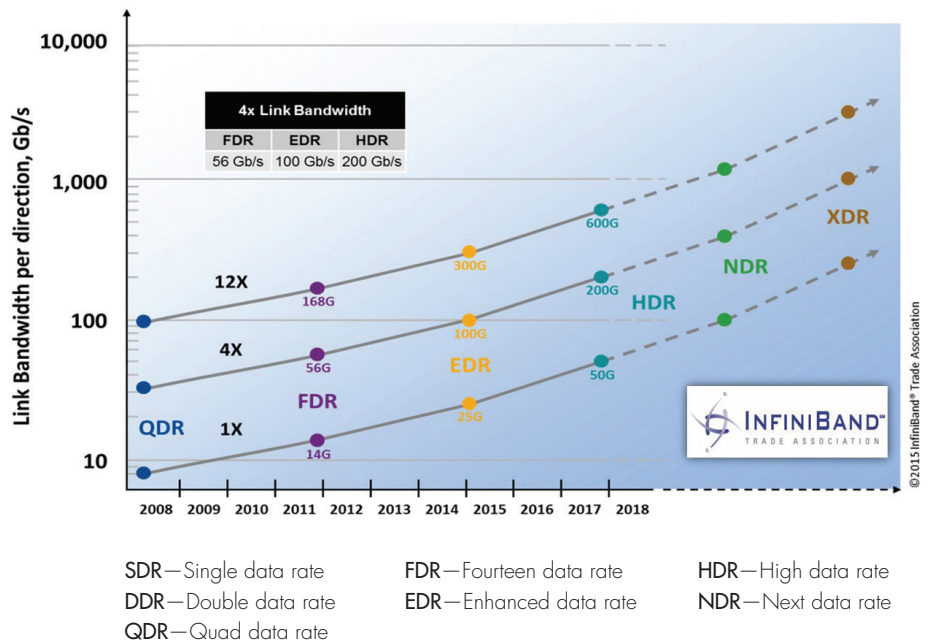

**Figure 7: InfiniBand Technology Roadmap from the IB Trade Association home page ([www.infinibandta.org](http://www.infinibandta.org))**

The SDR application for multimode (IB 1x-SX) and all singlemode applications (IB 1x-LX) uses two fibers with LC connectors for transmission while all other applications starting with DDR use the multifiber MPO connector.

Application	Connector Type
IB 1x-SX	2 x LC
IB 4x-SX	1 x MPO 12f
IB 8x-SX	2 x MPO 12f
IB 12x-SX	2 x MPO 12f
IB 1x-LX	2 x LC
IB 4x-LX	2 x LC

**Table 15: InfiniBand applications and fiber-optic connector types**

## 6.1. Channel lengths

The maximum channel length depends on the data rate, the number of parallel lines and the optical fiber type. The following table summarizes this.

Channel lengths / m						
Fiber type	IB 1x-SX SDR/DDR/QDR	IB 4x-SX SDR/DDR	IB 8x-SX SDR/DDR	IB 12x-SX SDR/DDR	IB 1x-LX SDR/DDR/QDR	IB 4x-LX SDR
OM3, 50/125 μm	500/200/300	200/150	200/150	200/150	N/A	N/A
OM4, 50/125 μm*	500/200/300	200/150	200/150	200/150	N/A	N/A
OS1/OS2, 9/125μm	N/A	N/A	N/A	N/A	10 km for all	10 km

\* IB physical spec does not mention OM4. Hence OM4 is treated as OM3 in this table

**Table 16: InfiniBand channel lengths depending on applications and fiber types**

## 6.2. Channel power budgets for IB applications

Channel Budget / dB						
Fiber type	IB 1x-SX SDR/DDR	IB 4x-SX SDR/DDR	IB 8x-SX SDR/DDR	IB 12x-SX SDR/DDR	IB 1x-LX SDR/DDR	IB 4x-LX SDR
OM3, 50/125 μm	6/7.93	4.8/6.25	4.8/6.25	4.8/6.25	N/A	N/A
OM4, 50/125 μm*	6/7.93	4.8/6.25	4.8/6.25	4.8/6.25	N/A	N/A
OS1/OS2, 9/125μm	N/A	N/A	N/A	N/A	9/9.8	6.2

\* IB physical spec does not mention OM4. Hence OM4 is treated as OM3 in this table

**Table 17: Channel power budgets**

## Cabling System Overview

Designed for the requirements of modern data centers

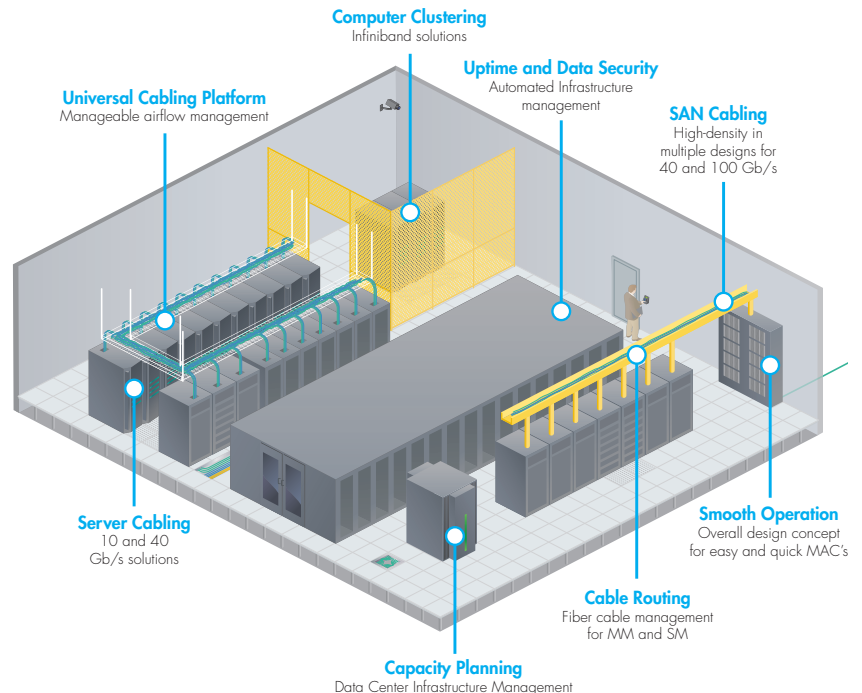

**Figure 8: Cabling system infrastructure**

**CommScope** (NASDAQ: COMM) helps companies around the world design, build and manage their wired and wireless networks. Our network infrastructure solutions help customers increase bandwidth; maximize existing capacity; improve network performance and availability; increase energy efficiency; and simplify technology migration. You will find our solutions in the largest buildings, venues and outdoor spaces; in data centers and buildings of all shapes, sizes and complexity; at wireless cell sites and in cable headends; and in airports, trains, and tunnels. Vital networks around the world run on CommScope solutions.



---

[www.commscope.com](http://www.commscope.com)

Visit our website or contact your local CommScope representative for more information.

© 2016 CommScope, Inc. All rights reserved.

All trademarks identified by ® or ™ are registered trademarks or trademarks, respectively, of CommScope, Inc.

This document is for planning purposes only and is not intended to modify or supplement any specifications or warranties relating to CommScope products or services.

WP201656.3-EN (01/16)