



SYSTIMAX Solutions®

Asia-Pacific Ordering Guide

(09/15)

Category 6A Products

SYSTIMAX 360™ GigaSPEED X10D® U/UTP Copper Cables	3
SYSTIMAX 360™ GigaSPEED X10D® Panels	4
SYSTIMAX 360™ GigaSPEED X10D® Information Outlets	5
SYSTIMAX 360™ GigaSPEED X10D® Patch Cords	5
SYSTIMAX 360™ GigaSPEED X10D® F/UTP Copper Cables	6
SYSTIMAX 360™ GigaSPEED X10D® F/UTP Patch Cords	6
SYSTIMAX 360™ GigaSPEED X10D® Shielded HD Information Outlets	7
SYSTIMAX 360™ GigaSPEED X10D® Shielded Modular Panels	7

Category 6 Products

SYSTIMAX 360™ GigaSPEED XL® Copper Cables	8
SYSTIMAX 360™ GigaSPEED XL® Panels	9
SYSTIMAX 360™ GigaSPEED XL® Information Outlets	10
SYSTIMAX 360™ GigaSPEED XL® Patch Cords	10

Category 5e Products

PowerSUM U/UTP Copper Cables	11
PowerSUM U/UTP Patch Panels	12
PowerSUM Information Outlets	12
PowerSUM Patch Cords	12

VisiPatch 360®

VisiPatch 360® Patch Panel Kits	13
VisiPatch 360® Cable Manager Kits	13
VisiPatch 360® GigaSPEED 4-pair Patch Cords	14
VisiPatch 360® 1-Pair Patch Cord	14
VisiPatch 360® to VisiPatch® GigaSPEED Hybrid Patch Cord	14

InstaPATCH® Cu

InstaPATCH® Cu Solutions	15
--------------------------	----

Modular Panels

SYSTIMAX 360™ Modular Panels	16
M4800/M4800A 1U High Density Modular Panels	16
M2000 Modular Patch Panels	16
M2100 Modular Patch Panels	16

Coaxial Solutions

Video Cables	17
Security Cables	18

Fiber Solutions

Fiber Optic Cable Configurator	19
Single Unit Distribution Cables	20
Multi Unit Distribution Cables	21
Interlocked Armor Distribution Cables	22
Indoor/Outdoor Cables	24
Outside Plant Cables	27

Fiber Connectivity

SYSTIMAX 360G2	
SYSTIMAX 360G2 Modular Fiber Shelves & Panels 1U, 2U & 4U	29
SYSTIMAX 360G2 Accessories	29
InstaPATCH 360 Modules	29
SYSTIMAX 360G2 Modular Cartridges	30
SYSTIMAX 360G2 Modular Distribution Panels	31
Fiber Optic Patch Cords Configurator	31
Fiber Optic Connectors	
Standard Fiber Optic Connectors	35
Fiber Optic QWIK II Connectors	36
Fiber Optic Adapters	
Standard Fiber Optic Adapters	37
SpeedPRO® Fiber Raceway	38

Infrastructure Management Solutions

SYSTIMAX imVision®	41
iPatch® Infrastructure Management Copper Panels	41
iPatch® Infrastructure Management Fiber Optic Shelves	42
SYSTIMAX 360™ iPatch® Fiber Shelves & Modules	42

Faceplates

APAC Faceplates	43
Stainless Steel Faceplates	43
Modular Outlet Wall Phone Faceplates	43
Modular Flush-Mount Faceplates	44
Modular Furniture Faceplates	44
Designer Faceplates	45
Flexible Adapters	46

Cable Management

19" Racks	47
Shelves	47
Filler Panels	47
Horizontal Cable Management	48
Vertical Cable Management	48



SYSTIMAX 360™ GigaSPEED X10D® U/UTP 1091B Non-Plenum Cables

MATERIAL ID	PRODUCT NUMBER	PAIR COUNT	JACKET COLOR	LENGHT	PACKAGING
760105759	1091B BL 4/23 R1000	4	Blue	1000 ft (305 m)	Reel
760107094	1091B BL 4/23 W1000	4	Blue	1000 ft (305 m)	We Tote Box
760105833	1091B BL 4/23 R3000	4	Blue	3000 ft (914 m)	Reel
760105871	1091B WH 4/23 R1000	4	White	1000 ft (305 m)	Reel
760107144	1091B WH 4/23 W1000	4	White	1000 ft (305 m)	We Tote Box
760105841	1091B WH 4/23 R3000	4	White	3000 ft (914 m)	Reel
760105114	1091B SL 4/23 R1000	4	Slate	1000 ft (305 m)	Reel
760107078	1091B SL 4/23 W1000	4	Slate	1000 ft (305 m)	We Tote Box
760105858	1091B SL 4/23 R3000	4	Slate	3000 ft (914 m)	Reel
760105742	1091B BK 4/23 R1000	4	Black	1000 ft (305 m)	Reel
760107086	1091B BK 4/23 W1000	4	Black	1000 ft (305 m)	We Tote Box
760105767	1091B LB 4/23 R1000	4	Light Blue	1000 ft (305 m)	Reel
760107102	1091B LB 4/23 W1000	4	Light Blue	1000 ft (305 m)	We Tote Box
760105775	1091B GR 4/23 R1000	4	Green	1000 ft (305 m)	Reel
760107110	1091B GR 4/23 W1000	4	Green	1000 ft (305 m)	We Tote Box
760105791	1091B RD 4/23 R1000	4	Red	1000 ft (305 m)	Reel
760107136	1091B RD 4/23 W1000	4	Red	1000 ft (305 m)	We Tote Box
760105783	1091B OR 4/23 R1000	4	Orange	1000 ft (305 m)	Reel
760107128	1091B OR 4/23 W1000	4	Orange	1000 ft (305 m)	We Tote Box
760105825	1091B YL 4/23 R1000	4	Yellow	1000 ft (305 m)	Reel
760107151	1091B YL 4/23 W1000	4	Yellow	1000 ft (305 m)	We Tote Box

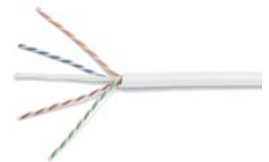

SYSTIMAX 360™ GigaSPEED X10D® U/UTP 3091B LSZH Cables

MATERIAL ID	PRODUCT NUMBER	PAIR COUNT	JACKET COLOR	LENGHT	PACKAGING
760106039	3091B BL 4/23 R1000	4	Blue	1000 ft (305 m)	Reel
760107326	3091B BL 4/23 W1000	4	Blue	1000 ft (305 m)	We Tote Box
760106062	3091B BL 4/23 R3000	4	Blue	3000 ft (914 m)	Reel
760105122	3091B WH 4/23 R1000	4	White	1000 ft (305 m)	Reel
760107318	3091B WH 4/23 W1000	4	White	1000 ft (305 m)	We Tote Box
760106054	3091B WH 4/23 R3000	4	White	3000 ft (914 m)	Reel
760106047	3091B SL 4/23 R1000	4	Slate	1000 ft (305 m)	Reel
760107334	3091B SL 4/23 W1000	4	Slate	1000 ft (305 m)	We Tote Box
760106070	3091B SL 4/23 R3000	4	Slate	3000 ft (914 m)	Reel

SYSTIMAX 360™ GigaSPEED X10D® 1100GS6 Panels



MATERIAL ID	PRODUCT NUMBER	DESCRIPTION	iPATCH READY
760152587	360-IPR-1100-E-GS6-1U-24	360 1100GS6 24-Port Evolve Patch Panel	X
760152595	360-IPR-1100-E-GS6-2U-48	360 1100GS6 48-Port Evolve Patch Panel	X
760151324	360-IPR-1100A-E-GS6-1U-24	360 1100GS6 24-Port Evolve Angled Patch Panel	X
760151779	360-IPR-1100A-E-GS6-2U-48	360 1100GS6 48-Port Evolve Angled Patch Panel	X



MATERIAL ID	PRODUCT NUMBER	DESCRIPTION
760151183	360-IPR-1100-GS6-DM6	360 1100GS6 Evolve Distribution Module 6-Port
760155739	360-E-KIT-1U	360 1U Evolve Panel Kit for both GS6 and GS3
760155747	360-E-KIT-2U	360 2U Evolve Panel Kit for both GS6 and GS3
760152785	360-A-E-KIT-1U	360 Angled 1U Evolve Panel Kit for both GS6 and GS3
760152793	360-A-E-KIT-2U	360 Angled 2U Evolve Panel Kit for both GS6 and GS3
760183244	360 and UNP Label Sheet US LTR	Label Sheet for 360 and Universal Panels, US letter
760186502	360 and UNP Label Sheet A4	Label Sheet for 360 and Universal Panels, A4

*Additional 1100GS6 products can be located in eCatalog on www.commscope.com or in the SYSTIMAX 360 Product Guide.

*Additional iPatch® Ready Modules, Panels and Shelves can be found in the Fiber Connectivity and iPatch Infrastructure Management Sections.

SYSTIMAX 360™ GigaSPEED X10D® PATCHMAX GS6 Panels



MATERIAL ID	PRODUCT NUMBER	DESCRIPTION	iPATCH READY
760102251	360-PM-GS6-2U-24	360 PATCHMAX GS6 24-Port Patch Panel	X
760128207	360-PM-GS6-2U-48	360 PATCHMAX GS6 48-Port Patch Panel	X

MATERIAL ID	PRODUCT NUMBER	DESCRIPTION
760102277	360-PM-GS6-DM6	360 PATCHMAX GS6 6-Port Distribution Module Kit
760128215	360-PM-GS6-DM12	360 PATCHMAX GS6 12-Port Distribution Module Kit
760108993	360-PM-KIT-2U-24	360 PATCHMAX 2U Panel Kit, 24-Port
760117408	360-PM-KIT-2U-48	360 PATCHMAX 2U Panel Kit, 48-Port
760183244	360 and UNP Label Sheet US LTR	Label Sheet for 360 and Universal Panels, US letter
760186502	360 and UNP Label Sheet A4	Label Sheet for 360 and Universal Panels, A4

*Additional iPatch® Ready Modules, Panels and Shelves can be found in the Fiber Connectivity and iPatch Infrastructure Management Sections.



SYSTIMAX 360™ GigaSPEED X10D® MGS600 Series Information Outlet

MATERIAL ID	PRODUCT NUMBER	COLOR	QUANTITY/PKG.
760092361	MGS600-003	Black	1
760092379	MGS600-112	Orange	1
760092387	MGS600-123	Yellow	1
760092403	MGS600-226	Green	1
760092411	MGS600-246	Ivory	1
760092429	MGS600-262	White	1
760092437	MGS600-270	Gray	1
760092445	MGS600-317	Red	1
760092452	MGS600-318	Blue	1
760092460	MGS600-361	Violet	1
760092478	MGS600-148	Almond	1

*Also available in bulk packs of 100



SYSTIMAX 360™ GigaSPEED X10D® 360GS10E Modular Patch Cords

MATERIAL ID	PRODUCT NUMBER	DESCRIPTION	MODULAR JACK COLOR	CORD COLOR OPTIONS	UOM	CABLE/CORDAGE LENGTH OPTIONS
CPCSSX2	360GS10E	360GS10E Solid Cordage	0	1,2,3,4,6,7,8,9,B,C,Z	F, M	3-100ft / 1-30m
CPCSSY2	360GS10E-P	360GS10E Solid Plenum Cordage	0	1,4,6,7,8,9,C,Z	F, M	3-100ft / 1-30m
CPCSSZ2	360GS10E-L	360GS10E Solid LSZH Cordage	0	1,2,3,4,6,7,8,9,B,C,Z	F, M	3-100ft / 1-30m
CPCS4X2	360GS10E117	360GS10E Single-ended Solid Cordage	0	1,2,3,4,6,7,8,9,B,C,Z	F, M	3-100ft / 1-30m
CPCS4Y2	360GS10E117-P	360GS10E Single-ended Solid Plenum Cordage	0	1,4,6,7,8,9,C,Z	F, M	3-100ft / 1-30m
CPCS4Z2	360GS10E117-L	360GS10E Single-ended Solid LSZH Cordage	0	1,2,3,4,6,7,8,9,B,C,Z	F, M	3-100ft / 1-30m

Ordering Material ID Example: **C P C S S X 2 - 0 2 F 0 0 7**

Information regarding T568A standard (A-wired) patch cord is available from your local sales representative.

*SecureMAX Patch Cords and Accessories are not available for sale in Europe, Russia, Australia and Japan.

Please contact your local sales representative to check availability in your country.

Cord Color Options: 1=BK (Black), 2=LB (Light Blue), 3=DG (Dark Gray), 4=GN (Spring Green), 6=OR (Orange), 7=RD (Red), 8=WH (White), 9=YL (Yellow), B=L (Lilac), C=SL (Slate), Z=BL (Blue)



SYSTIMAX 360™ GigaSPEED X10D® F/UTP 1291B Non-Plenum Cables

MATERIAL ID	PRODUCT NUMBER	DESCRIPTION
760081364	1291B BL 4/23 R1000	GigaSPEED X10D 1291B Category 6A F/UTP Non-Plenum Cable, blue jacket, 4 pair count, 1000 ft (305 m) length, reel
760081398	1291B SL 4/23 R1000	GigaSPEED X10D 1291B Category 6A F/UTP Non-Plenum Cable, slate jacket, 4 pair count, 1000 ft (305 m) length, reel
760081406	1291B WH 4/23 R1000	GigaSPEED X10D 1291B Category 6A F/UTP Non-Plenum Cable, white jacket, 4 pair count, 1000 ft (305 m) length, reel

SYSTIMAX 360™ GigaSPEED X10D® F/UTP 3091B LSZH Cables

MATERIAL ID	PRODUCT NUMBER	DESCRIPTION
760081315	3291B BL 4/23 R1000	GigaSPEED X10D 3291B Category 6A F/UTP Low Smoke Zero Halogen Cable, blue jacket, 4 pair count, 1000 ft (305 m) length, reel
760081323	3291B WH 4/23 R1000	GigaSPEED X10D 3291B Category 6A F/UTP Low Smoke Zero Halogen Cable, white jacket, 4 pair count, 1000 ft (305 m) length, reel

SYSTIMAX 360™ GigaSPEED X10D® F/UTP and S/FTP Modular Patch Cords

MATERIAL ID	PRODUCT NUMBER	DESCRIPTION	MODULAR JACK COLOR	CORD COLOR OPTIONS	UOM	CABLE/CORDAGE LENGTH OPTIONS
CPCGGJ2	G10FP	G10FP on 1295 Solid F/UTP Cordage	0	1,2,3,8,9	F, M	3-300ft /1-100m
CPCG4J2	G10FP117	G10FP Single-ended on 1295 Solid F/UTP Cordage	0	1,2,3,8,9	F, M	3-300ft /1-100m
CPCGGL2	G10FPL	G10FP on 3295 Solid LSZH F/UTP Cordage	0	8	F, M	3-300ft /1-100m
CPCG4L2	G10FP117-L	G10FP Single-ended on 3295 Solid LSZH F/UTP Cordage	0	8	F, M	3-300ft /1-100m

Ordering Material ID Example: **C P C G G J 2 - 0 2 F 0 0 7**



SYSTIMAX 360™ GigaSPEED X10D® Shielded High Density Information Outlet

MATERIAL ID	PRODUCT NUMBER	COLOR
760152801	HGS620	GigaSPEED X10D Shielded High Density Information Outlet
760152827	HGS-A-KS-BK	HGS Keystone Adapter Bulk Pack
760154211	HGS-A-MS-Black	HGS M-Series Adapter
760154252	HGS-A-MS-Blue	HGS M-Series Adapter
760154187	HGS-A-MS-White	HGS M-Series Adapter
760154195	HGS-A-MS-Ivory	HGS M-Series Adapter
760154229	HGS-A-MS-Orange	HGS M-Series Adapter
760154096	H61A-226-Green	HGS Icon Strip Bulk Pack
760154112	H61A-318-Blue	HGS Icon Strip Bulk Pack
760154120	H61A-317-Red	HGS Icon Strip Bulk Pack
760154070	H61A-003-Black	HGS Icon Strip Bulk Pack
760154047	H61A-262-White	HGS Icon Strip Bulk Pack
760154104	H61A-123-Yellow	HGS Icon Strip Bulk Pack
760152876	HGS-TTS	Hand Termination Tool - Seat Only



SYSTIMAX 360™ GigaSPEED X10D® Shielded Modular Panels

MATERIAL ID	PRODUCT NUMBER	COLOR
760150144	360-IPR-MFTP-E-HD6B-1U-24	SYSTIMAX 360 GigaSPEED X10D Evolve High Density F/UTP Modular Panel, 24-port
760151498	360-IPR-MFTP-E-HD6B-2U-48	SYSTIMAX 360 GigaSPEED X10D Evolve High Density F/UTP Modular Panel, 48-port
760151290	360-IPR-MFTPA-E-HD6B-1U-24	SYSTIMAX 360 GigaSPEED X10D Evolve High Density F/UTP Angled Modular Panel, 24-port
760151746	360-IPR-MFTPA-E-HD6B-2U-48	SYSTIMAX 360 GigaSPEED X10D Evolve High Density F/UTP Angled Modular Panel, 48-port
760151480	360-MFTP-LKB	SYSTIMAX 360 GigaSPEED X10D Evolve High Density F/UTP Modular Panel Label Kit
760152371	360-iP-M-E-HD6B-1U-24	SYSTIMAX 360 iPatch Evolve High Density F/UTP Modular Panel, 24-port
760152389	360-iP-M-E-HD6B-2U-48	SYSTIMAX 360 iPatch Evolve High Density F/UTP Modular Panel, 48-port
760152538	360-E-C-1U	360 Evolve Panel Front Cover 1U
760152546	360-E-C-2U	360 Evolve Panel Front Cover 2U



SYSTIMAX 360™ GigaSPEED XL® U/UTP 1071E Non-Plenum Cables

MATERIAL ID	PRODUCT NUMBER	PAIR COUNT	JACKET COLOR	LENGHT	PACKAGING
760004697	1071E BL 4/23 R1000	4	Blue	1000 ft (305 m)	Reel
760004689	1071E BL 4/23 W1000	4	Blue	1000 ft (305 m)	We Tote Box
760080671	1071E BL 4/23 R3000	4	Blue	3000 ft (914 m)	Reel
700214208	1071E WH 4/23 R1000	4	White	1000 ft (305 m)	Reel
760040089	1071E WH 4/23 R3000	4	White	3000 ft (914 m)	Reel
700212046	1071E WH 4/23 W1000	4	White	1000 ft (305 m)	We Tote Box
700211923	1071E SL 4/23 R1000	4	Slate	1000 ft (305 m)	Reel
760040097	1071E SL 4/23 R3000	4	Slate	3000 ft (914 m)	Reel
700211931	1071E SL 4/23 W1000	4	Slate	1000 ft (305 m)	We Tote Box
700211956	1071E LB 4/23 R1000	4	Light Blue	1000 ft (305 m)	Reel
760040105	1071E LB 4/23 R3000	4	Light Blue	3000 ft (914 m)	Reel
700211964	1071E LB 4/23 W1000	4	Light Blue	1000 ft (305 m)	We Tote Box
700212053	1071E SG 4/23 R1000	4	Spring Green	1000 ft (305 m)	Reel
760116722	1071E SG 4/23 R3000	4	Spring Green	3000 ft (914 m)	Reel
700212061	1071E SG 4/23 W1000	4	Spring Green	1000 ft (305 m)	We Tote Box
700212111	1071E OR 4/23 R1000	4	Orange	1000 ft (305 m)	Reel
760116293	1071E OR 4/23 R3000	4	Orange	3000 ft (914 m)	Reel
700212103	1071E OR 4/23 W1000	4	Orange	1000 ft (305 m)	We Tote Box
700211980	1071E YL 4/23 R1000	4	Yellow	1000 ft (305 m)	Reel
760080689	1071E YL 4/23 R3000	4	Yellow	3000 ft (914 m)	Reel
700211998	1071E YL 4/23 W1000	4	Yellow	1000 ft (305 m)	We Tote Box

* Other colors available, contact your local sales representative



SYSTIMAX 360™ GigaSPEED XL® U/UTP 3071E LSZH Cables

MATERIAL ID	PRODUCT NUMBER	PAIR COUNT	JACKET COLOR	LENGHT	PACKAGING
700216484	3071 004EBL 4/23 R1000	4	Blue	1000 ft (305 m)	Reel
700216492	3071 004EBL 4/23 W1000	4	Blue	1000 ft (305 m)	We Tote Box
760070466	3071 004E3BL 4/23 R3000	4	Blue	3000 ft (914 m)	Reel
760081265	3071 004EBL 4/23 R3000	4	Blue	3000 ft (914 m)	Reel
760011544	3071 004E3WH 4/23 W1000	4	White	1000 ft (305 m)	We Tote Box
700216443	3071 004EWH 4/23 R1000	4	White	1000 ft (305 m)	Reel
700216450	3071 004EWH 4/23 W1000	4	White	1000 ft (305 m)	We Tote Box
760006346	3071 004E3WH 4/23 R1000	4	White	1000 ft (305 m)	Reel
760081281	3071 004EWH 4/23 R3000	4	White	3000 ft (914 m)	Reel
700216419	3071 004ESL 4/23 R1000	4	Slate	1000 ft (305 m)	Reel
760095554	3071 004ESL 4/23 W1000	4	Slate	1000 ft (305 m)	We Tote Box

* Other colors available, contact your local sales representative



SYSTIMAX 360™ GigaSPEED XL® 1100GS3 Panels

MATERIAL ID	PRODUCT NUMBER	DESCRIPTION	iPATCH READY
760152561	360-IPR-1100-E-GS3-1U-24	360 1100GS3 24-Port Evolve Patch Panel	X
760152579	360-IPR-1100-E-GS3-2U-48	360 1100GS3 48-Port Evolve Patch Panel	X
760151308	360-IPR-1100A-E-GS3-1U-24	360 1100GS3 24-Port Evolve Angled Patch Panel	X
760151753	360-IPR-1100A-E-GS3-2U-48	360 1100GS3 48-Port Evolve Angled Patch Panel	X

MATERIAL ID	PRODUCT NUMBER	DESCRIPTION
760151167	360-IPR-1100-GS3-DM6	360 1100GS3 Evolve Distribution Module 6-Port
760155739	360-E-KIT-1U	360 1U Evolve Panel Kit for both GS6 and GS3
760155747	360-E-KIT-2U	360 2U Evolve Panel Kit for both GS6 and GS3
760152785	360-A-E-KIT-1U	360 Angled 1U Evolve Panel Kit for both GS6 and GS3
760152793	360-A-E-KIT-2U	360 Angled 2U Evolve Panel Kit for both GS6 and GS3
760183244	360 and UNP Label Sheet US LTR	Label Sheet for 360 and Universal Panels, US letter
760186502	360 and UNP Label Sheet A4	Label Sheet for 360 and Universal Panels, A4

*Additional 1100GS3 products can be located in eCatalog on www.commscope.com.

*Additional iPatch® Ready Modules, Panels and Shelves can be found in the Fiber Connectivity and iPatch Infrastructure Management Sections.

SYSTIMAX 360™ GigaSPEED XL® PATCHMAX® GS3 Panels



MATERIAL ID	PRODUCT NUMBER	DESCRIPTION	iPATCH READY
760102244	360-PM-GS3-2U-24	360 PATCHMAX GS3 24-Port Patch Panel	X
760117366	360-PM-GS3-2U-48	360 PATCHMAX GS3 48-Port Patch Panel	X

MATERIAL ID	PRODUCT NUMBER	DESCRIPTION
760108993	360-PM-KIT-2U-24	360 PATCHMAX 2U Panel Kit, 24-Port
760117408	360-PM-KIT-2U-48	360 PATCHMAX 2U Panel Kit, 48-Port
760117382	360-PM-GS3-DM-12	360 PATCHMAX GS3 12-Port Distribution Module Kit
760183244	360 and UNP Label Sheet US LTR	Label Sheet for 360 and Universal Panels, US letter
760186502	360 and UNP Label Sheet A4	Label Sheet for 360 and Universal Panels, A4

*Additional PATCHMAX GS3 products can be located in eCatalog on www.commscope.com or in the SYSTIMAX 360 Product Guide.



SYSTIMAX 360™ GigaSPEED XL® MGS400 Information Outlet

MATERIAL ID	PRODUCT NUMBER	COLOR	QUANTITY/PKG.
700206667	MGS400-003	Black	1
700206683	MGS400-112	Orange	1
700206691	MGS400-123	Yellow	1
700206709	MGS400-226	Green	1
700206725	MGS400-262	White	1
700206741	MGS400-317	Red	1
700206758	MGS400-318	Blue	1
700206675	MGS400-361	Violet	1
760070326	MGS400-215	Misty Cream	1
700206717	MGS400-246	Ivory	1
700206733	MGS400-270	Gray	1

*Also available in bulk packs of 100



SYSTIMAX 360™ GigaSPEED XL® GS8E Modular Patch Cords (U/UTP)

MATERIAL ID	PRODUCT NUMBER	DESCRIPTION	MODULAR JACK COLOR	CORD COLOR OPTIONS	UOM	CABLE/CORDAGE LENGTH OPTIONS
CPC3312	GS8E	GS8E Stranded Cordage Modular Patch Cord	0	1,2,3,4,6,7,8,9,B,Z	F, M	1-100ft / 1-30m
CPC3372	GS8E-SP	GS8E Solid Plenum Cable Modular Cord	0	1,4,6,7,8,9,B,C,Z	F, M	1-100ft / 1-30m
CPC3392	GS8E-L	GS8E Stranded LSZH Cordage	0	2,4,6,7,8,9,B,Z	F, M	1-100ft / 1-30m
CPC3482	GS8E117-S	GS8E Single-ended Solid Cable	0	1,2,3,4,6,7,8,9,B,C,Z	F, M	1-100ft / 1-30m
CPC3472	GS8E117-SP	GS8E Single End Solid Plenum Modular Cord	0	1,4,6,7,8,9,B,C,Z	F, M	1-100ft / 1-30m
CPC3422	GS8E117-SL	GS8E Single-ended Solid LSZH Cable	0	8	F, M	1-100ft / 1-30m

Ordering Material ID Example: **C P C 3 3 1 2 - 0 1 F 0 0 1**

Cord Color Options: 1=BK (Black), 2=LB (Light Blue), 3=DG (Dark Gray), 4=GN (Spring Green), 6=OR (Orange), 7=RD (Red), 8=WH (White), 9=YL (Yellow), B=LL (Lilac), C=SL (Slate), Z=BL (Blue)



PowerSUM U/UTP 1061B Series Non-Plenum Cables

MATERIAL ID	PRODUCT NUMBER	PAIR COUNT	JACKET COLOR	LENGTH	PACKAGING
107323636	1061B BL 4/24 R1000	4	Blue	1000 ft (305 m)	Reel
107251696	1061B BL 4/24 W1000	4	Blue	1000 ft (305 m)	We Tote Box
107819575	1061B WH 4/24 W1000	4	White	1000 ft (305 m)	We Tote Box
107091936	1061B SL 4/24 W1000	4	Slate	1000 ft (305 m)	We Tote Box
760004705	1061C BL 4/24 R1000	4	Blue	1000 ft (305 m)	Reel
760004671	1061C BL 4/24 W1000	4	Blue	1000 ft (305 m)	We Tote Box
107849283	1061C WH 4/24 R1000	4	White	1000 ft (305 m)	Reel
107147787	1061C WH 4/24 W1000	4	White	1000 ft (305 m)	We Tote Box
106836943	1061C SL 4/24 R1000	4	Slate	1000 ft (305 m)	Reel
106836950	1061C SL 4/24 W1000	4	Slate	1000 ft (305 m)	We Tote Box



PowerSUM U/UTP Low Smoke Zero Halogen Cables

MATERIAL ID	PRODUCT NUMBER	PAIR COUNT	JACKET COLOR	LENGTH	PACKAGING
760081232	3061 004ABL 4/24 R3000	4	Blue	3000 ft (914 m)	Reel
107573537	3061 004AWH 4/24 R1000	4	White	1000 ft (305 m)	Reel
107573545	3061 004AWH 4/24 W1000	4	White	1000 ft (305 m)	We Tote Box
760081257	3061 004AWH 4/24 R3000	4	White	3000 ft (914 m)	Reel



PowerSUM Modular Patch Panels

MATERIAL ID	PRODUCT NUMBER	DESCRIPTION
760182907	1100-U-PS 24	1100 Universal PS Panel 24 Port
760182915	1100-U-PS 48	1100 Universal PS Panel 48 Port
760182923	1100A-U-PS-24	1100 Angled Universal PS Panel 24 Port
760182931	1100A-U-PS-48	1100 Angled Universal PS Panel 48 Port
760183244	360 and UNP Label Sheet US LTR	Label Sheet for 360 and Universal Panels, US letter
760186502	360 and UNP Label Sheet A4	Label Sheet for 360 and Universal Panels, A4



PATCHMAX® PowerSUM 1100PS Patch Panels

MATERIAL ID	PRODUCT NUMBER	DESCRIPTION
760205260	PM2150PSE-24	PATCHMAX PowerSUM Patch Panel, 24-Port
760205278	PM2150PSE-48	PATCHMAX PowerSUM Patch Panel, 48-Port



PowerSUM Information Outlets

MATERIAL ID	PRODUCT NUMBER	WIRING	COLOR	QUANTITY
108232695	MPS100E-003	T568A, T568B	Black	1
108232703	MPS100E-112	T568A, T568B	Orange	1
108232711	MPS100E-123	T568A, T568B	Yellow	1
108232729	MPS100E-226	T568A, T568B	Green	1
108232737	MPS100E-246	T568A, T568B	Electrical Ivory	1
108232745	MPS100E-262	T568A, T568B	Electrical White	1
108232752	MPS100E-270	T568A, T568B	Electrical Gray	1
108232760	MPS100E-317	T568A, T568B	Red	1
108232778	MPS100E-318	T568A, T568B	Blue	1
108337726	MPS100E-361	T568A, T568B	Violet	1
108480484	MPS100E-215	T568A, T568B	Misty Cream	1



PowerSUM D8PS Modular Patch Cord

MATERIAL ID	PRODUCT NUMBER	DESCRIPTION	JACK COLOR	CORD COLOR OPTIONS	UOM	CABLE/CORDAGE LENGTH OPTIONS
CPC6442	D8PS	D8PS Single End Stranded Cordage Modular Patch Cord, T568B	0	1,2,3,4,6,7,8,9,B,Z	F, M	1-100ft / 1-30m
CPC6642	D8PS	D8PS Stranded Cordage Modular Patch Cord	0	1,2,3,4,6,7,8,9,B,Z	F, M	1-100ft / 1-30m
CPC6441	D8PS	D8PS Single End Stranded Cordage Modular Patch Cord, T568A	0	1,2,3,4,6,7,8,9,B,Z	F, M	1-100ft / 1-30m

Ordering Material ID Example: **CPC6642-02F007**

Information regarding T568A standard (A-wired) patch cord is available from your local sales representative.

Cord Color Options: 1=BK (Black), 2=LB (Light Blue), 3=DG (Dark Gray), 4=GN (Spring Green), 6=OR (Orange), 7=RD (Red), 8=WH (White), 9=YL (Yellow), B=L (Lilac), C=SL (Slate), Z=BL (Blue)



VisiPatch 360® Patch Panel Kits

MATERIAL ID	PRODUCT NUMBER	DESCRIPTION	CONTENTS
760049445	VP360-4U-32P	VisiPatch 360 4U (32-Ports) Kit	VisiPatch 360 Back Panel 4U, 1 VisiPatch 360 Wiring Block, 4 VisiPatch 360 Wiring Block Cover, 4 VisiPatch 360 Connecting Block, 32 VisiPatch Label Holder, 4 White Label, 12
760049452	VP360-12U-96P	VisiPatch 360 12U (96-Ports) Kit	VisiPatch 360 Back Panel 12U, 1 VisiPatch 360 Wiring Block, 12 VisiPatch 360 Wiring Block Cover, 12 VisiPatch 360 Connecting Block, 96 VisiPatch Label Holder, 12 White Label, 12



VisiPatch 360® Cable Manager Kits - Vertical

MATERIAL ID	PRODUCT NUMBER	DESCRIPTION	CONTENTS
760060285	VP360-12U-10VTCM	VisiPatch 360 12U Vertical Trough Cable Management Kit with Door, 10" wide	VisiPatch 360 12U VTCM Door, 1 4U Spacer Module, 3 4U Spacer Module Extender, 3 Macro Cable/Cord Retainer, 3



VisiPatch 360® Cable Manager Kits - Horizontal

MATERIAL ID	PRODUCT NUMBER	DESCRIPTION	CONTENTS
760060301	VP360-HCM-Kit-27	VisiPatch 360 Horizontal Cable Management Kit, 27" wide	4U Back Panel Base, 2 Horizontal CM Trough, 4 Horizontal Trough Cover, 2
760060343	VP360-HCM-Kit-19	VisiPatch 360 Horizontal Cable Management Kit, 19" wide	
760060863	VP360-HCM-Kit-29	VisiPatch 360 Horizontal Cable Management Kit, 29" wide	
760060871	VP360-HCM-Kit-37	VisiPatch 360 Horizontal Cable Management Kit, 37" wide	

VisiPatch 360®

Copper Solutions



VisiPatch 360® GigaSPEED X10D Patch Cords

MATERIAL ID	PRODUCT NUMBER	DESCRIPTION	JACK COLOR	CORD COLOR OPTIONS	UOM	CABLE/CORDAGE LENGTH OPTIONS
CPCFFX2	VP360T-VP360T-P8X10D	VisiPatch360 - VisiPatch360 X10D 4-pair Solid Cord T	0	1,2,3,4,6,7,8,9,B,C,Z	F, M	7-100ft / 2-30m
CPCFFZ2	VP360T-VP360T-P8X10D-L	VisiPatch 360 - VisiPatch 360 4 pair Solid LSZH Patch Cord T	0	1,2,3,4,6,7,8,9,B,C,Z	F, M	7-100ft / 2-30m
CPCFSX2	VP360T-360GS10E	VisiPatch360 - 360GS10E X10D 4-pair Solid Hybrid Cord T	0	1,2,3,4,6,7,8,9,B,C,Z	F, M	7-100ft / 2-30m
CPCFSZ2	VP360T-360GS10E-L	VisiPatch 360 - 360GS10E 4 pair Solid LSZH Patch Cord T	0	1,2,3,4,6,7,8,9,B,C,Z	F, M	7-100ft / 2-30m

Ordering Material ID Example: **CPCFFX2 - 0 3 F 0 0 7**

VisiPatch 360® GigaSPEED Xpress® Patch Cords

MATERIAL ID	PRODUCT NUMBER	DESCRIPTION	JACK COLOR	CORD COLOR OPTIONS	UOM	CABLE/CORDAGE LENGTH OPTIONS
CPCFFP2	VP360-VP360-P8XP	VisiPatch 360 - VisiPatch® 360 GigaSPEED Xpress™ 4 Pair Patch Cord	0	1,2,3,4,6,7,8,9,B,C,Z	F, M	1-100ft / 1-30m

Ordering Material ID Example: **CPCFFP2 - 0 3 F 0 0 7**

VisiPatch 360® GigaSPEED XL Patch Cords

MATERIAL ID	PRODUCT NUMBER	DESCRIPTION	JACK COLOR	CORD COLOR OPTIONS	UOM	CABLE/CORDAGE LENGTH OPTIONS
CPCFF12	VP360-VP360-P8XL	VisiPatch360 - VisiPatch 360 XL 4-pair Cord	0	1,2,3,4,6,7,8,9,B,Z	F, M	1-100ft / 1-30m
CPCF312	VP360-GS8E	VisiPatch360 - GS8E XL 4-pair Hybrid Cord	0	1,2,3,4,6,7,8,9,B,Z	F, M	1-100ft / 1-30m

Ordering Material ID Example: **CPCFF12 - 0 3 F 0 0 7**

VisiPatch 360® 1 Pair Patch Cord

MATERIAL ID	PRODUCT NUMBER	DESCRIPTION	JACK COLOR	CORD COLOR OPTIONS	UOM	CABLE/CORDAGE LENGTH OPTIONS
CPCFF62	VP360-VP360-P2PS	VisiPatch360-VisiPatch360 1-pair Cord	0	3	F, M	1-100ft / 1-30m

Ordering Material ID Example: **CPCFF62 - 0 3 F 0 0 7**



VisiPatch® to VisiPatch Hybrid Patch Cord Configurator

MATERIAL ID BASE CODE	PRODUCT NUMBER	DESCRIPTION	TYPE	INFORMATION OUTLET COLOR	JACKET COLOR										UOM	CABLE/CORDAGE LENGTH OPTIONS
					BK	LB	DG	GN	OR	RD	WH	YL	LL	BL		
CPCF512	VP360-VP-P8GS	VisiPatch® 360 to VisiPatch 4 Pair Patch Cord	Patch Cord	0	1	2	3	4	6	7	8	9	B	Z	F,M	1-100ft/1-30m

Ordering Material ID Example: **CPCF512 - 0 6 F 0 2 5**

Cord Color Options: 1=BK (Black), 2=LB (Light Blue), 3=DG (Dark Gray), 4=GN (Spring Green), 6=OR (Orange), 7=RD (Red), 8=WH (White), 9=YL (Yellow), B=LL (Lilac), C=SL (Slate), Z=BL (Blue)

InstaPATCH® Cu Configurator



C A A A C - 1 1 H A 8 8 F 050

Cable Type

A	Cat 6A X10D - U/UTP (Plenum)
B	Cat 6A X10D - U/UTP (Riser)
C	Cat 6A X10D - U/UTP (LSZH)
D	Cat 6A X10D - F/UTP (Plenum)
E	Cat 6A X10D - F/UTP (Riser)
F	Cat 6A X10D - F/UTP (LSZH)
G	Cat 6 XL - U/UTP (Plenum)
H	Cat 6 XL - U/UTP (Riser)
J	Cat 6 XL - U/UTP (LSZH)
Q	Cat 6A X10D - S/FTP (LSZH)

Link

B	6
C	8
D	12
E	16
F	18
G	24

Orientation A

1	Trident Series Flat
2	Right Paired Flat
3	Right Series Flat
4	Left Paired Flat
5	Left Series Flat
6	Trident Paired Flat
A	Trident Series Angled
B	Right Paired Angled
C	Right Series Angled
D	Left Paired Angled
E	Left Series Angled
F	Trident Paired Angled

Bundling

H	Hook-n-loop
S	Sleeving

Outlet Color

0	Not Applicable
1	Black (BK)
2	Blue (BL)
8	White (WH)

UOM

F	Feet
M	Meter

Length

XXX

Connector A

A	Outlet* - Single Row Standard Density
B	Outlet* - Dual Row Standard Density
G	RJ45 Plug
N	1100 Module
R	360 1100 Evolve Module
S	OneLink 2x6
T	OneLink 2x4

Orientation B

1	Trident Series Flat
2	Right Paired Flat
3	Right Series Flat
4	Left Paired Flat
5	Left Series Flat
6	Trident Paired Flat
A	Trident Series Angled
B	Right Paired Angled
C	Right Series Angled
D	Left Paired Angled
E	Left Series Angled
F	Trident Paired Angled
X	Not Applicable

Labeling

A	Generic Label
----------	---------------

Jacket Color

3	Dark Gray (DG)
8	White (WH)
C	Slate (SL)
Z	Blue (BL)

Connector B

A	Outlet* - Single Row Standard Density
B	Outlet* - Dual Row Standard Density
G	RJ45 Plug
N	1100 Module
R	360 1100 Evolve Module
S	OneLink 2x6
T	OneLink 2x4
X	Unterminated

Configurations are not limited to the above.

Please contact your local sales representative for more information.

* Note: Connector A and Connector B Applications:

A Outlet - Single Row Standard Density (supports M2400, 360M FTP panel)

B Outlet - Dual Row Standard Density (supports M2000, M2100, M3200, 360M UTP panels)



SYSTIMAX 360™ Modular Panels

MATERIAL ID	PRODUCT NUMBER	DESCRIPTION
760187187	360-E-MOD-1U-24	360 Evolve 24 Port Panel
760187179	360 Evolve M-Series Adapter - 4 Pk	360 Evolve M-Series Adapter - 4 Pk
760187278	360 E Mod Label Sheet US LTR	360 Modular Panel Label Sheet US LTR
760187286	360 E Mod Label Sheet A4	360 Modular Panel Label Sheet A4
760187195	360-E-MOD-2U-48	360 Evolve 48 Port Panel
760187203	360-E-ANG-MOD-1U-24	360 Evolve Angled 24 Port Panel
760187211	360-E-ANG-MOD-2U-48	360 Evolve Angled 48 Port Panel



M4800/M4800A 1U High Density Modular Panels

MATERIAL ID	PRODUCT NUMBER	DESCRIPTION
760105429	M4800-1U-GS	M4800 1U 48-Port Panel - GS
760104307	M4800-1U-PS	M4800 1U 48-Port Panel - PS
760109744	M4800A-1U-GS	M4800A 1U Angled 48-Port Panel - GS
760109736	M4800A-1U-PS	M4800A 1U Angled 48-Port Panel - PS
760104737	360-RCM-RM	Rear Cable Management System (Rack Mountable)



M2000 Modular Patch Panels

MATERIAL ID	PRODUCT NUMBER	DESCRIPTION
760207274	M2000-24 1U	M2000 24-Port 1U Panel
760207282	M2000-48 2U	M2000 48-Port 2U Panel
760207290	M2000A-24 1U (Angled)	M2000A 24-Port 1U Panel (angled)
760207308	M2000A-48 2U (Angled)	M2000A 48-Port 2U Panel (angled)



M2100 Modular Patch Panels

MATERIAL ID	PRODUCT NUMBER	DESCRIPTION
760101220	M2100-24	M2100-1U Modular Patch Panel
760077842	M2100-48	M2100-2U Modular Patch Panel

Series 6 Cables



PRODUCT NUMBER	DESCRIPTION	JACKET COLOR	PACKAGING
2274V	75 Ω, Plenum, Series 6, 60% Al braid, BC conductor	White	Reel
2275V	75 Ω, Plenum, Series 6, 60% Al braid, CCS conductor	Black and White	Reel
2276V	75 Ω, Plenum, Series 6, 90% Al braid, CCS conductor	Black, White and Gray	Reel
2279V	75 Ω, Plenum, Series 6, 95% TC braid, BC conductor	White	Reel
5730G	75 Ω, Non-Plenum, Series 6, 60% Al braid, CCS conductor	Black, White, Gray and Beige	Reel and Box
5740R	75 Ω, Non-Plenum, Series 6, Quad Shield, CCS conductor	Black, White and Neutral	Reel and Box
5781R	75 Ω, Non-Plenum, Series 6, Quad Shield, BC conductor	Black and White	Reel and Box
5786G	75 Ω, Non-Plenum, Series 6, 60% Al braid, Dual Version of 5730	Black and Gray	Reel
5730	75 Ω, Non-Plenum, Series 6, 60% Al braid, CCS Conductor	Black, White, Gray and Beige	Reel and Box
5781	75 Ω, Non-Plenum, Series 6, 60% Al braid, CCS Conductor	Black and White	Reel and Box

Series 11 Cables



PRODUCT NUMBER	DESCRIPTION	JACKET COLOR	PACKAGING
2287V	75 Ω, Plenum, Series 11, Quad Shield, CCS conductor	White	Reel
5916G	75 Ω, Non-Plenum, Series 11, 60% Al braid, CCS conductor	Black	Reel
5917	75 Ω, Burial (OSP), Series 11, 60% Al braid, CCS conductor	Black, White and Gray	Reel
5940R	75 Ω, Non-Plenum, Series 11, Quad Shield, CCS conductor	Black	Reel
5916	75 Ω, Non-Plenum, Series 11, 60% Al braid, CCS Conductor	Black	Reel
5940	75 Ω, Non-Plenum, Series 11, Quad Shield, CCS Conductor	Black	Reel

Series 59 Cables

PRODUCT NUMBER	DESCRIPTION	JACKET COLOR	PACKAGING
5572	75 Ω, Non-Plenum, Series 59, 60% Al braid, CCS Conductor	Black	Reel
5540	75 Ω, Non-Plenum, Series 59, 40% Al braid, CCS Conductor	Black	Reel

Series 6 Cables

PRODUCT NUMBER	DESCRIPTION	JACKET COLOR	PACKAGING
2277V	75 Ω, Plenum, Series 6, 95% BC braid, BC Conductor	White	Reel
5654	75 Ω, Non-Plenum, Series 6, 95% BC braid, BC Conductor	Black	Reel
5720	75 Ω, Burial (OSP), Series 6, 92% BC braid, BC conductor	Black	Reel
5654	75 Ω, Non-Plenum, Series 6, 95% BC braid, BC Conductor	Black	Reel
2277V	75 Ω, Plenum, Series 6, 95% BC braid, BC Conductor	White	Reel



Series 59 Cables

PRODUCT NUMBER	DESCRIPTION	JACKET COLOR	PACKAGING
2037V	75 Ω, Plenum, Series 59, 93% BC braid, BC conductor	Black and White	Reel and Box
2054V	75 Ω, Plenum, Series 59, 93% BC braid, BC conductor w 2-18 AWG	White	Reel
5553G	75 Ω, Non-Plenum, Series 59, 95% BC braid, BC Conductor	Black, White and Gray	Reel and Box
5554*	75 Ω, Non-Plenum, Series 59, 95% BC braid, BC conductor w 2-18AWG	Black and White	Reel
5554G	75 Ω, Non-Plenum, Series 59, 95% BC braid, BC conductor w 2-18AWG	White	Reel
5554M*	Same as 5554 w/messenger	Black	Reel
5553	75 Ω, Non-Plenum, Series 59, 95% BC braid, BC Conductor	Black, White and Gray	Reel and Box
5554	75 Ω, Non-Plenum, Series 59, 95% BC braid, BC Conductor	Black	Reel

P - 012 - DS - 5L - F SU AQ

Position 1 Position 2 Position 3 Position 4 Position 5 Position 6 Position 7

Sample Part Number

Position 1: Cable Style

P - 012 - DS - 5L - FSUAQ

D All Dry Outside Plant	Z Zero Halogen Indoor/Outdoor	O Outside Plant (Arid Core®)
M Messenger	P Plenum	S Outside Plant (All Dielectric, Self-Supporting)
N Zero Halogen (Indoor Only)	R Riser	

Position 2: Fiber Count

P - 012 - DS - 5L - FSUAQ

Total Fiber Count (XXX variable in catalog number.)

Position 3: Cable Construction

P - 012 - DS - 5L - FSUAQ

Outside Plant Cable Constructions

LA Stranded Loose Tube Armored	DA Drop Armored	MN Mini-drop All Dielectric
LN Stranded Loose Tube Non Armored All Dielectric	DF Flat Drop All-Dielectric	
LD Stranded Loose Tube All Dielectric/Dual Jacket	DN Drop All Dielectric	
L2 Stranded Loose Tube Dual Jacket/Single Armor	CN Central Tube Non Armored All Dielectric	
L3 Stranded Loose Tube Triple Jacket/Dual Armor	CA Central Tube Armored	

Indoor & Indoor/Outdoor Cable Constructions

Tight Buffer	Loose Tube	
DS Distribution OD I/O Plenum Distribution	LN Stranded Loose Tube Non Armored All Dielectric	CN Central Tube All Dielectric
ZC Zipcord	LH Stranded Loose Tube Heavy Duty Non Armored	

FiberGuard® For tight buffered and loose tube I/O cables only, use first character of the construction code above plus one of the following:

- Z** Aluminum Armor w/Jacket
- LH** cables cannot be Interlocked Armored

Position 4: Fiber Type

P - 012 - DS - 5L - FSUAQ

8W TeraSPEED single-mode	5M 50µm, LazrSPEED 150, multimode (OM2+)	5K 50µm, LazrSPEED 550, multimode (OM4)
6F OptiSPEED 62.5/125µm FDDI Grade, multimode (OM1)	5L 50µm, LazrSPEED 300, multimode (OM3)	

CM Composite (single-mode & multimode) **HY** Hybrid (Fiber, Copper, Coax)
 *XY variable in catalog number

Position 5: Jacket Print

P - 012 - DS - 5L - FSUAQ

F Printed in Feet (Standard)	M Printed in Meters	X Special Print
-------------------------------------	----------------------------	------------------------

Position 6: Miscellaneous Values

P - 012 - DS - 5L - FSUAQ

For cordage, value indicates outside diameter; otherwise additional description

01-12 Fiber Count per Subunit	SU Single Unit	MU Multi Unit
--------------------------------------	-----------------------	----------------------

Cordage

16 1.6mm Jacket OD	20 2.0mm Jacket	25 2.5mm Jacket OD	29 2.9mm Jacket OD
---------------------------	------------------------	---------------------------	---------------------------

Position 7: Color Field

P - 012 - DS - 5L - FSUAQ

For Outside Plant Cables, this field designates color of stripe/tracer. Outside Plant Cables are manufactured with a standard black jacket — No Stripe (NS). Stripes (tracers) are also available in the following colors (min. order required):

BL Blue	OR Orange	GR Green	BR Brown	SL Slate	WH White
RD Red	BK Black	YL Yellow	VI Violet	RS Rose	AQ Aqua

For Distribution Cables, this field indicates jacket color. Standard jacket colors:

BK Black for Indoor/Outdoor and Tight Buffer Outside Plant	YL Yellow for single-mode
OR Orange for 62.5 Multimode & Composite	AQ Aqua for LazrSPEED & LazrSPEED Composites
SL Slate for 62.5 Multimode & Composite	

*ZZ variable in catalog number. *I/O and OSP Cables are black jacket only

For Indoor Distribution Cables and Zipcords. Available Non Standard jacket colors: (min. order required)

BL Blue	OR Orange	GR Green	BR Brown	SL Slate	WH White
RD Red	BK Black	YL Yellow	VI Violet	RS Rose	AQ Aqua

Positions 8-11: When Position 4 is CM

P - 012 - DS - CM - FSUAQ 8W 006 5L 006

Position 8: First Fiber Type	Position 10: Second Fiber Type	Pos. 8	Pos. 9	Pos. 10	Pos. 11
Position 9: First Fiber Count	Position 11: Second Fiber Count				

When single-mode and multimode fibers are used in a composite, then single-mode is positioned first

Positions 8-11: When Position 4 is HY

O - 012 - DN - HY - F12NS 8W 006 F6SSBW GSM 40T

Position 8: Fiber Type	Position 10: Copper Type	Position 12: Tube Size	Pos. 8	Pos. 9	Pos. 10	Pos. 11	Pos. 12
Position 9: Fiber Count	Position 11: Messenger Description						

When no messenger is present, Tube Size moves to Position 11 and there is no Position 12. When Position 3 is LH, LN or LA, Position 8 is 25D, 20G or 20T
 *Other options are available that are not currently listed in the above chart.

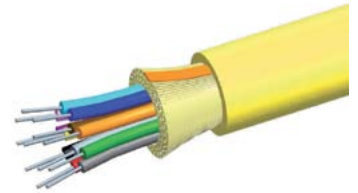

LSZH Single Unit Distribution Cables

Material ID	Product Number	Fiber Count	Outer Diameter inch/mm	Min. Bend Radius		Max. Tensile Load		Weight kg/km
				Loaded inch/cm	Unloaded inch/cm	Short Term lbs./Newton	Long Term lbs./Newton	
760012153	N-006-DS-5K-FSUAQ	6	.20/5.1	3.8/9.5	1.9/4.8	300/1335	90/400	24
760012161	N-012-DS-5K-FSUAQ	12	.24/6.0	4.7/12.1	2.4/6.0	300/1335	90/400	36
760019117	N-024-DS-5K-FSUAQ	24	.33/8.4	6.6/16.7	3.3/8.4	300/1335	90/400	66
700009780	N-006-DS-5L-FSUAQ	6	.20/5.1	3.8/9.5	1.9/4.8	300/1335	90/400	24
700009749	N-012-DS-5L-FSUAQ	12	.24/6.0	4.7/12.1	2.4/6.0	300/1335	90/400	36
760019109	N-024-DS-5L-FSUAQ	24	.33/8.4	6.6/16.7	3.3/8.4	300/1335	90/400	66
700009806	N-006-DS-5M-FSUAQ	6	.20/5.1	3.8/9.5	1.9/4.8	300/1335	90/400	24
700009764	N-012-DS-5M-FSUAQ	12	.24/6.0	4.7/12.1	2.4/6.0	300/1335	90/400	36
760019091	N-024-DS-5M-FSUAQ	24	.33/8.4	6.6/16.7	3.3/8.4	300/1335	90/400	66
760004242	N-006-DS-8W-FSUYL	6	.20/5.1	3.8/9.5	1.9/4.8	300/1335	90/400	24
760004267	N-012-DS-8W-FSUYL	12	.24/6.0	4.7/12.1	2.4/6.0	300/1335	90/400	36
760019091	N-024-DS-8W-FSUYL	24	.33/8.4	6.6/16.7	3.3/8.4	300/1335	90/400	66
760008469	N-006-DS-6F-FSUOR	6	.20/5.1	3.8/9.5	1.9/4.8	300/1335	90/400	24
760008444	N-012-DS-6F-FSUOR	12	.24/6.0	4.7/12.1	2.4/6.0	300/1335	90/400	36
760001903	N-024-DS-6F-FSUOR	24	.33/8.4	6.6/16.7	3.3/8.4	300/1335	90/400	66

Riser Single Unit Distribution Cables

MATERIAL ID	PRODUCT NUMBER	FIBER COUNT	OUTER DIAMETER inch/mm	MIN. BEND RADIUS		MAX. TENSILE LOAD		WEIGHT	
				LOADED inch/cm	UNLOADED inch/cm	SHORT TERM lbs./Newton	LONG TERM lbs./Newton	lbs./1000'	kg/1000'
760012104	R-006-DS-5K-FSUAQ	6	.20/5.1	3.8/9.5	1.9/4.8	300/1335	90/400	15.2	23
760012112	R-012-DS-5K-FSUAQ	12	.24/6.0	4.7/12.1	2.4/6.0	300/1335	90/400	21.7	32.2
760018564	R-024-DS-5K-FSUAQ	24	.33/8.4	6.6/16.7	3.3/8.4	300/1335	90/400	37.9	56.4
700208143	R-006-DS-5L-FSUAQ	6	.20/5.1	3.8/9.5	1.9/4.8	300/1335	90/400	15.2	23
700208150	R-012-DS-5L-FSUAQ	12	.24/6.0	4.7/12.1	2.4/6.0	300/1335	90/400	21.7	32.2
760018556	R-024-DS-5L-FSUAQ	24	.33/8.4	6.6/16.7	3.3/8.4	300/1335	90/400	37.9	56.4
700203078	R-006-DS-5M-FSUAQ	6	.20/5.1	3.8/9.5	1.9/4.8	300/1335	90/400	15.2	23
700203086	R-012-DS-5M-FSUAQ	12	.24/6.0	4.7/12.1	2.4/6.0	300/1335	90/400	21.7	32.2
760018549	R-024-DS-5M-FSUAQ	24	.33/8.4	6.6/16.7	3.3/8.4	300/1335	90/400	37.9	56.4
760004424	R-006-DS-8W-FSUYL	6	.20/5.1	3.8/9.5	1.9/4.8	300/1335	90/400	15.2	23
760004440	R-012-DS-8W-FSUYL	12	.24/6.0	4.7/12.1	2.4/6.0	300/1335	90/400	21.7	32.2
760018515	R-024-DS-8W-FSUYL	24	.33/8.4	6.6/16.7	3.3/8.4	300/1335	90/400	37.9	56.4
700009509	R-006-DS-6F-FSUSL	6	.20/5.1	3.8/9.5	1.9/4.8	300/1335	90/400	15.2	23
700009384	R-012-DS-6F-FSUSL	12	.24/6.0	4.7/12.1	2.4/6.0	300/1335	90/400	21.7	32.2
760018531	R-024-DS-6F-FSUSL	24	.33/8.4	6.6/16.7	3.3/8.4	300/1335	90/400	37.9	56.4
700010176	R-006-DS-6F-FSUOR	6	.20/5.1	3.8/9.5	1.9/4.8	300/1335	90/400	15.2	23
700010168	R-012-DS-6F-FSUOR	12	.24/6.0	4.7/12.1	2.4/6.0	300/1335	90/400	21.7	32.2
760125005	R-024-DS-6F-FSUOR	24	.33/8.4	6.6/16.7	3.3/8.4	300/1335	90/400	37.9	56.4

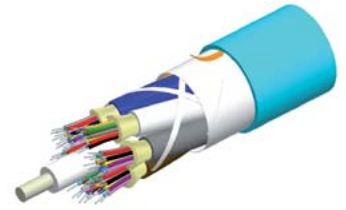

LSZH Multi Unit Distribution Cables

Material ID	Product Number	Fiber Count	Outer Diameter inch/mm	Min. Bend Radius		Max. Tensile Load		Weight kg/km
				Loaded inch/cm	Unloaded inch/cm	Short Term lbs./Newton	Long Term lbs./Newton	
700211121	N-048-DS-5L-FMUAQ	48	.63/16.1	12.7/32.2	6.3/16.1	800/3560	240/1068	224
700211139	N-072-DS-5L-FMUAQ	72	.79/20.0	15.8/40.1	7.9/20.0	1000/4450	300/1335	360
700211089	N-048-DS-5M-FMUAQ	48	.63/16.1	12.7/32.2	6.3/16.1	800/3560	240/1068	224
700211097	N-072-DS-5M-FMUAQ	72	.79/20.0	15.8/40.1	7.9/20.0	1000/4450	300/1335	360
760004291	N-048-DS-8W-FMUYL	48	.63/16.1	12.7/32.2	6.3/16.1	800/3560	240/1068	224
760004309	N-072-DS-8W-FMUYL	72	.79/20.0	15.8/40.1	7.9/20.0	1000/4450	300/1335	360
700009103	N-048-DS-6F-FMUOR	48	.63/16.1	12.7/32.2	6.3/16.1	800/3560	240/1068	224
700009012	N-072-DS-6F-FMUOR	72	.79/20.0	15.8/40.1	7.9/20.0	1000/4450	300/1335	360

Riser Multi Unit Distribution Cables

MATERIAL ID	PRODUCT NUMBER	FIBER COUNT	OUTER DIAMETER inch/mm	MIN. BEND RADIUS		MAX. TENSILE LOAD		WEIGHT	
				LOADED inch/cm	UNLOADED inch/cm	SHORT TERM lbs./Newton	LONG TERM lbs./Newton	lbs./1000'	kg/1000'
760026849	R-048-DS-5K-FMUAQ	48	.63/16.1	12.7/32.2	6.3/16.1	800/3560	240/1068	143	212
760026856	R-072-DS-5K-FMUAQ	72	.79/20.0	15.8/40.1	7.9/20.0	1000/4450	300/1335	232	345
760026872	R-144-DS-5K-FMUAQ	144	1.03/26.1	20.5/52.2	10.3/26.1	1000/4450	300/1335	350	522
700208218	R-048-DS-5L-FMUAQ	48	.63/16.1	12.7/32.2	6.3/16.1	800/3560	240/1068	143	212
700208226	R-072-DS-5L-FMUAQ	72	.79/20.0	15.8/40.1	7.9/20.0	1000/4450	300/1335	232	345
760018861	R-144-DS-5L-FMUAQ	144	1.03/26.1	20.5/52.2	10.3/26.1	1000/4450	300/1335	350	522
700203110	R-048-DS-5M-FMUAQ	48	.63/16.1	12.7/32.2	6.3/16.1	800/3560	240/1068	143	212
700203128	R-072-DS-5M-FMUAQ	72	.79/20.0	15.8/40.1	7.9/20.0	1000/4450	300/1335	232	345
760024810	R-144-DS-5M-FMUAQ	144	1.03/26.1	20.5/52.2	10.3/26.1	1000/4450	300/1335	350	522
760004473	R-048-DS-8W-FMUYL	48	.63/16.1	12.7/32.2	6.3/16.1	800/3560	240/1068	143	212
760004481	R-072-DS-8W-FMUYL	72	.79/20.0	15.8/40.1	7.9/20.0	1000/4450	300/1335	232	345
760018887	R-144-DS-8W-FMUYL	144	1.03/26.1	20.5/52.2	10.3/26.1	1000/4450	300/1335	350	522
700009087	R-048-DS-6F-FMUSL	48	.63/16.1	12.7/32.2	6.3/16.1	800/3560	240/1068	143	212
700008998	R-072-DS-6F-FMUSL	72	.79/20.0	15.8/40.1	7.9/20.0	1000/4450	300/1335	232	345
760055046	R-144-DS-6F-FMUSL	144	1.03/26.1	20.5/52.2	10.3/26.1	1000/4450	300/1335	350	522
760125021	R-048-DS-6F-FMUOR	48	.63/16.1	12.7/32.2	6.3/16.1	800/3560	240/1068	143	212
760125047	R-072-DS-6F-FMUOR	72	.79/20.0	15.8/40.1	7.9/20.0	1000/4450	300/1335	232	345
760125054	R-144-DS-6F-FMUOR	144	1.03/26.1	20.5/52.2	10.3/26.1	1000/4450	300/1335	350	522



Interlock Armor Plenum Distribution Cables

MATERIAL ID	PRODUCT NUMBER	FIBER COUNT	OUTER DIAMETER inch/mm	MIN. BEND RADIUS		MAX. TENSILE LOAD lbs./Newton	CRUSH RESISTANCE	WEIGHT	
				LOADED inch/cm	UNLOADED inch/cm			lbs. / 1000'	kg/ 1000'
760128181	P-006-DZ-5K-FSUAQ	6	0.51/12.8	10.1/27.5	7.1/18.0	225/1001	90N/mm	95	142
760128017	P-012-DZ-5K-FSUAQ	12	0.51/12.8	10.1/27.5	7.1/18.0	225/1001	90N/mm	101	151
760127910	P-024-DZ-5K-FSUAQ	24	0.69/17.4	13.7/34.8	9.6/24.4	300/1335	90N/mm	206	307
760125971	P-048-DZ-5K-FMUAQ	48	0.91/23.0	18.1/46.0	12.7/32.2	300/1335	85N/mm	302	449
760128108	P-072-DZ-5K-FMUAQ	72	1.11/28.1	22.1/56.1	15.5/39.3	300/1335	85N/mm	418	622
760127927	P-144-DZ-5K-FMUAQ	144	1.31/33.1	26.1/66.3	18.3/46.4	300/1335	90N/mm	574	854
760127639	P-006-DZ-5L-FSUAQ	6	0.51/12.8	10.1/27.5	7.1/18.0	225/1001	90N/mm	95	142
760127647	P-012-DZ-5L-FSUAQ	12	0.51/12.8	10.1/27.5	7.1/18.0	225/1001	90N/mm	101	151
760127902	P-024-DZ-5L-FSUAQ	24	0.69/17.4	13.7/34.8	9.6/24.4	300/1335	90N/mm	206	307
760127670	P-048-DZ-5L-FMUAQ	48	0.91/23.0	18.1/46.0	12.7/32.2	300/1335	85N/mm	302	449
760127688	P-072-DZ-5L-FMUAQ	72	1.11/28.1	22.1/56.1	15.5/39.3	300/1335	85N/mm	418	622
760127696	P-006-DZ-5M-FSUAQ	6	0.51/12.8	10.1/27.5	7.1/18.0	225/1001	90N/mm	95	142
760127704	P-012-DZ-5M-FSUAQ	12	0.51/12.8	10.1/27.5	7.1/18.0	225/1001	90N/mm	101	151
760127878	P-024-DZ-5M-FSUAQ	24	0.69/17.4	13.7/34.8	9.6/24.4	300/1335	90N/mm	206	307
760127738	P-048-DZ-5M-FMUAQ	48	0.91/23.0	18.1/46.0	12.7/32.2	300/1335	85N/mm	302	449
760127746	P-072-DZ-5M-FMUAQ	72	1.11/28.1	22.1/56.1	15.5/39.3	300/1335	85N/mm	418	622
760127993	P-144-DZ-5M-FMUAQ	144	1.31/33.1	26.1/66.3	18.3/46.4	300/1335	90N/mm	574	854
760126011	P-006-DZ-6F-FSUSL	6	0.51/12.8	10.1/27.5	7.1/18.0	225/1001	90N/mm	95	142
760127795	P-006-DZ-8W-FSUYL	6	0.51/12.8	10.1/27.5	7.1/18.0	225/1001	90N/mm	95	142
760127803	P-012-DZ-8W-FSUYL	12	0.51/12.8	10.1/27.5	7.1/18.0	225/1001	90N/mm	101	151
760127886	P-024-DZ-8W-FSUYL	24	0.69/17.4	13.7/34.8	9.6/24.4	300/1335	90N/mm	206	307
760127837	P-048-DZ-8W-FMUYL	48	0.91/23.0	18.1/46.0	12.7/32.2	300/1335	85N/mm	302	449
760127845	P-072-DZ-8W-FMUYL	72	1.11/28.1	22.1/56.1	15.5/39.3	300/1335	85N/mm	418	622
760128009	P-144-DZ-8W-FMUYL	144	1.31/33.1	26.1/66.3	18.3/46.4	300/1335	90N/mm	574	854



Interlock Armor Riser Distribution Cables

MATERIAL ID	PRODUCT NUMBER	FIBER COUNT	OUTER DIAMETER inch/mm	MIN. BEND RADIUS		MAX. TENSILE LOAD lbs./Newton	CRUSH RESISTANCE	WEIGHT	
				LOADED inch/cm	UNLOADED inch/cm			lbs. / 1000'	kg/1000'
760127506	R-006-DZ-5K-FSUAQ	6	0.51/12.8	10.1/25.7	7.1/18.0	300/1335	85N/mm	92	136
760127514	R-012-DZ-5K-FSUAQ	12	0.51/12.8	10.1/25.7	7.1/18.0	300/1335	85N/mm	98	146
760126524	R-024-DZ-5K-FSUAQ	24	0.61/15.4	12.1/30.7	8.5/21.5	300/1335	85N/mm	131	195
760126540	R-048-DZ-5K-FMUAQ	48	0.91/23.0	18.1/46.0	12.7/32.2	300/1335	85N/mm	294	438
760126557	R-072-DZ-5K-FMUAQ	72	1.11/28.1	22.1/56.1	15.5/39.3	300/1335	85N/mm	397	591
760127456	R-144-DZ-5K-FMUAQ	144	1.36/34.4	27.1/68.8	19.0/48.2	300/1335	85N/mm	558	830
760127175	R-006-DZ-5L-FSUAQ	6	0.51/12.8	10.1/25.7	7.1/18.0	300/1335	85N/mm	92	136
760127183	R-012-DZ-5L-FSUAQ	12	0.51/12.8	10.1/25.7	7.1/18.0	300/1335	85N/mm	98	146
760127381	R-024-DZ-5L-FSUAQ	24	0.61/15.4	12.1/30.7	8.5/21.5	300/1335	85N/mm	131	195
760127209	R-048-DZ-5L-FMUAQ	48	0.91/23.0	18.1/46.0	12.7/32.2	300/1335	85N/mm	294	438
760127217	R-072-DZ-5L-FMUAQ	72	1.11/28.1	22.1/56.1	15.5/39.3	300/1335	85N/mm	397	591
760127464	R-144-DZ-5L-FMUAQ	144	1.36/34.4	27.1/68.8	19.0/48.2	300/1335	85N/mm	558	830
760127225	R-006-DZ-5M-FSUAQ	6	0.51/12.8	10.1/25.7	7.1/18.0	300/1335	85N/mm	92	136
760127233	R-012-DZ-5M-FSUAQ	12	0.51/12.8	10.1/25.7	7.1/18.0	300/1335	85N/mm	98	146
760127415	R-024-DZ-5M-FSUAQ	24	0.61/15.4	12.1/30.7	8.5/21.5	300/1335	85N/mm	131	195
760127266	R-048-DZ-5M-FMUAQ	48	0.91/23.0	18.1/46.0	12.7/32.2	300/1335	85N/mm	294	438
760127274	R-072-DZ-5M-FMUAQ	72	1.11/28.1	22.1/56.1	15.5/39.3	300/1335	85N/mm	397	591
760127472	R-144-DZ-5M-FMUAQ	144	1.36/34.4	27.1/68.8	19.0/48.2	300/1335	85N/mm	558	830
760127308	R-006-DZ-8W-FSUYL	6	0.51/12.8	10.1/25.7	7.1/18.0	300/1335	85N/mm	92	136
760126623	R-006-DZ-6F-FSUSL	6	0.51/12.8	10.1/25.7	7.1/18.0	300/1335	85N/mm	92	136
760127316	R-012-DZ-8W-FSUYL	12	0.51/12.8	10.1/25.7	7.1/18.0	300/1335	85N/mm	98	146
760127373	R-024-DZ-8W-FSUYL	24	0.61/15.4	12.1/30.7	8.5/21.5	300/1335	85N/mm	131	195
760127357	R-048-DZ-8W-FMUYL	48	0.91/23.0	18.1/46.0	12.7/32.2	300/1335	85N/mm	294	438
760127480	R-072-DZ-8W-FMUYL	72	1.11/28.1	22.1/56.1	15.5/39.3	300/1335	85N/mm	397	591
760127472	R-144-DZ-8W-FMUYL	144	1.26/31.9	27.1/68.8	19.0/48.2	300/1335	85N/mm	558	830

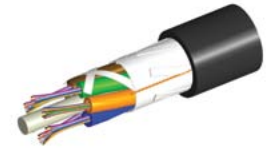

Gel-free Stranded Loose Tube Riser Cables

MATERIAL ID	PRODUCT NUMBER	FIBER COUNT	OUTER DIAMETER inch/mm	MIN. BEND RADIUS		MAX. TENSILE LOAD		WEIGHT	
				LOADED inch/cm	UNLOADED inch/cm	SHORT TERM lbs./Newton	LONG TERM lbs./Newton	lbs. / 1000'	kg/ 1000'
760101295	R-012-LN-5K-F12BK/25D	12	.45/11.5	9.0/23.0	4.5/11.5	607/2700	440	79	118
760101303	R-024-LN-5K-F12BK/25D	24	.45/11.5	9.0/23.0	4.5/11.5	607/2700	440	79	118
760101329	R-072-LN-5K-F12BK/25D	72	.47/11.9	9.3/23.8	4.7/11.9	607/2700	440	85	127
760128199	R-288-LN-5K-F12BK/25D	288	.79/20.2	15.9/40.4	7.9/20.2	607/2700	440	208	310
760086413	R-024-LN-5L-F12BK/25D	24	.45/11.5	9.0/23.0	4.5/11.5	607/2700	440	79	118
760086355	R-006-LN-8W-F06BK/25D	6	.45/11.5	9.0/23.0	4.5/11.5	607/2700	440	79	118
760086371	R-012-LN-8W-F12BK/25D	12	.45/11.5	9.0/23.0	4.5/11.5	607/2700	440	79	118
760086405	R-024-LN-8W-F12BK/25D	24	.45/11.5	9.0/23.0	4.5/11.5	607/2700	440	79	118
760086470	R-048-LN-8W-F12BK/25D	48	.45/11.5	9.0/23.0	4.5/11.5	607/2700	440	79	118
760086538	R-072-LN-8W-F12BK/25D	72	.47/11.9	9.3/23.8	4.7/11.9	607/2700	440	85	127
760086652	R-144-LN-8W-F12BK/25D	144	.68/17.2	13.5/34.4	6.8/17.2	607/2700	440	176	262
760086710	R-288-LN-8W-F12BK/25D	288	.79/20.2	15.9/40.4	7.9/20.2	607/2700	440	208	310
760086348	R-006-LN-6F-F06BK/25D	6	.45/11.5	9.0/23.0	4.5/11.5	607/2700	440	79	118
760086363	R-012-LN-6F-F12BK/25D	12	.45/11.5	9.0/23.0	4.5/11.5	607/2700	440	79	118
760086397	R-024-LN-6F-F12BK/25D	24	.45/11.5	9.0/23.0	4.5/11.5	607/2700	440	79	118
760086462	R-048-LN-6F-F12BK/25D	48	.45/11.5	9.0/23.0	4.5/11.5	607/2700	440	79	118
760086520	R-072-LN-6F-F12BK/25D	72	.47/11.9	9.3/23.8	4.7/11.9	607/2700	440	85	127
760086645	R-144-LN-6F-F12BK/25D	144	.68/17.2	13.5/34.4	6.8/17.2	607/2700	440	176	262
760086702	R-288-LN-6F-F12BK/25D	288	.79/20.2	15.9/40.4	7.9/20.2	607/2700	440	208	310

* Crush Resistance



LSZH All-Dielectric Drop Indoor/Outdoor Cables

Material ID	Product Number	Fiber Count	Outer Diameter inch/mm	Min. Bend Radius		Max Tensile Load lbs./Newton	Crush Resistance	Weight kg/km
				Loaded inch/cm	Unloaded inch/cm			
760083360	Z-006-DN-5L-F06BK/20G	6	0.32/8.2	16.4/3.5	8.3/3.3	300/1334	90/400	72
760111369	Z-012-DN-5L-F12BK/20G	12	0.32/8.2	16.4/3.5	8.3/3.3	300/1334	90/400	72
760083386	Z-024-DN-5L-F12BK/20G	24	0.32/8.2	16.4/3.5	8.3/3.3	300/1334	90/400	72
760083303	Z-006-DN-8W-F06BK/20G	6	0.32/8.2	16.4/3.5	8.3/3.3	300/1334	90/400	72
760111337	Z-012-DN-8W-F12BK/20G	12	0.32/8.2	16.4/3.5	8.3/3.3	300/1334	90/400	72
760083329	Z-024-DN-8W-F12BK/20G	24	0.32/8.2	16.4/3.5	8.3/3.3	300/1334	90/400	72
760113027	Z-006-DN-6F-F06BK/20G	6	0.32/8.2	16.4/3.5	8.3/3.3	300/1334	90/400	72
760113035	Z-012-DN-6F-F12BK/20G	12	0.32/8.2	16.4/3.5	8.3/3.3	300/1334	90/400	72

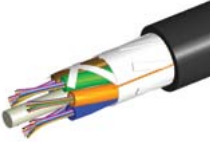

LSZH Indoor/Outdoor Loose Tube Cables

Material ID	Product Number	Fiber Count	Outer Diameter inch/mm	Min. Bend Radius		Max Tensile Load lbs./Newton	Crush Resistance	Weight kg/km
				Loaded inch/cm	Unloaded inch/cm			
760091827	Z-006-LN-5L-F06BK/20G	6	.43/11.0	5.2/13.1	10.2/26.1	607/2700	800	127
760091835	Z-012-LN-5L-F12BK/20G	12	.43/11.0	5.2/13.1	10.2/26.1	607/2700	800	127
760091843	Z-024-LN-5L-F12BK/20G	24	.43/11.0	5.2/13.1	10.2/26.1	607/2700	800	127
760122119	Z-048-LN-5L-F12BK/20G	48	.43/11.0	5.2/13.1	10.2/26.1	607/2700	800	127
760100198	Z-072-LN-5L-F12BK/20G	72	.43/11.0	5.2/13.1	10.2/26.1	607/2700	800	127
760091728	Z-006-LN-8W-F06BK/20G	6	.43/11.0	5.2/13.1	10.2/26.1	607/2700	800	127
760091736	Z-012-LN-8W-F12BK/20G	12	.43/11.0	5.2/13.1	10.2/26.1	607/2700	800	127
760091744	Z-024-LN-8W-F12BK/20G	24	.43/11.0	5.2/13.1	10.2/26.1	607/2700	800	127
760091769	Z-048-LN-8W-F12BK/20G	48	.43/11.0	5.2/13.1	10.2/26.1	607/2700	800	127
760091785	Z-072-LN-8W-F12BK/20G	72	.43/11.0	5.2/13.1	10.2/26.1	607/2700	800	127
760091819	Z-144-LN-8W-F12BK/20G	144	.58/14.7	6.4/16.2	12.8/32.4	607/2700	800	225
760124685	Z-006-LN-6F-F06BK/20G	6	.43/11.0	5.2/13.1	10.2/26.1	607/2700	800	127
760111286	Z-012-LN-6F-F12BK/20G	12	.43/11.0	5.2/13.1	10.2/26.1	607/2700	800	127



LSZH Indoor/Outdoor HTS Stranded Loose Tube All Dielectric Cables (Rodent Resistant)

Material ID	Product Number	Fiber Count	Outer Diameter inch/mm	Min. Bend Radius		Max Tensile Load lbs./Newton	Crush Resistance	Weight kg/km
				Loaded inch/cm	Unloaded inch/cm			
760100727	Z-012-LN-8W-F12BK/20G/HTS	12	0.51/13.1	10.3/26.2	5.1/13.1	1000/4448*	-	169
760100735	Z-024-LN-8W-F12BK/20G/HTS	24	0.51/13.1	10.3/26.2	5.1/13.1	1000/4448*	-	169
760100743	Z-048-LN-8W-F12BK/20G/HTS	48	0.51/13.1	10.3/26.2	5.1/13.1	1000/4448*	-	169
760100750	Z-072-LN-8W-F12BK/20G/HTS	72	.51/13.1	10.3/26.2	5.1/13.1	1000/4448*	-	169
760100768	Z-144-LN-8W-F12BK/20G/HTS	144	.64/16.2	12.7/32.4	6.4/16.2	1000/4448*	-	256

* Installation Load lbs./Newton



Light Duty Riser Indoor/Outdoor Cables

MATERIAL ID	PRODUCT NUMBER	FIBER COUNT	OUTER DIAMETER inch/mm	MIN. BEND RADIUS		INSTALLATION LOAD lbs./Newton	WEIGHT	
				LOADED inch/cm	UNLOADED inch/cm		lbs. / 1000'	kg/ 1000'
760112649	R-002-LN-5K-F02BK/25D/LTS	2	.41/10.4	10.4/4.1	20.9/8.2	300/1335	63	94
760112656	R-006-LN-5K-F02BK/25D/LTS	6	.41/10.4	10.4/4.1	20.9/8.2	300/1335	63	94
760112664	R-012-LN-5K-F02BK/25D/LTS	12	.41/10.4	10.4/4.1	20.9/8.2	300/1335	63	94
760112672	R-024-LN-5K-F02BK/25D/LTS	24	.41/10.4	10.4/4.1	20.9/8.2	300/1335	63	94
760112680	R-036-LN-5K-F02BK/25D/LTS	36	.41/10.4	10.4/4.1	20.9/8.2	300/1335	63	94
760112698	R-048-LN-5K-F02BK/25D/LTS	48	.41/10.4	10.4/4.1	20.9/8.2	300/1335	63	94
760112581	R-002-LN-5L-F02BK/25D/LTS	2	.41/10.4	10.4/4.1	20.9/8.2	300/1335	63	94
760112599	R-006-LN-5L-F02BK/25D/LTS	6	.41/10.4	10.4/4.1	20.9/8.2	300/1335	63	94
760112607	R-012-LN-5L-F02BK/25D/LTS	12	.41/10.4	10.4/4.1	20.9/8.2	300/1335	63	94
760112615	R-024-LN-5L-F02BK/25D/LTS	24	.41/10.4	10.4/4.1	20.9/8.2	300/1335	63	94
760112623	R-036-LN-5L-F02BK/25D/LTS	36	.41/10.4	10.4/4.1	20.9/8.2	300/1335	63	94
760112631	R-048-LN-5L-F02BK/25D/LTS	48	.41/10.4	10.4/4.1	20.9/8.2	300/1335	63	94
760112524	R-002-LN-5M-F02BK/25D/LTS	2	.41/10.4	10.4/4.1	20.9/8.2	300/1335	63	94
760112532	R-006-LN-5M-F02BK/25D/LTS	6	.41/10.4	10.4/4.1	20.9/8.2	300/1335	63	94
760112540	R-012-LN-5M-F02BK/25D/LTS	12	.41/10.4	10.4/4.1	20.9/8.2	300/1335	63	94
760112557	R-024-LN-5M-F02BK/25D/LTS	24	.41/10.4	10.4/4.1	20.9/8.2	300/1335	63	94
760112565	R-036-LN-5M-F02BK/25D/LTS	36	.41/10.4	10.4/4.1	20.9/8.2	300/1335	63	94
760112573	R-048-LN-5M-F02BK/25D/LTS	48	.41/10.4	10.4/4.1	20.9/8.2	300/1335	63	94

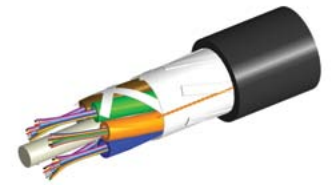

All Dry Outside Stranded Loose Tube Non-Armored All Dielectric Gel-free Buffer Tube Cables

MATERIAL ID	PRODUCT NUMBER	FIBER COUNT	OUTER DIAMETER inch/mm	MIN. BEND RADIUS		MAX. TENSILE LOAD lbs./Newton	CRUSH RESISTANCE	WEIGHT	
				LOADED inch/cm	UNLOADED inch/cm			lbs. / 1000'	kg/ 1000'
760054270	D-006-LN-5K-F06NS	6	.40/10.2	8.0/20.4	4.0/10.2	607/2700	440	45	67
760054288	D-012-LN-5K-F12NS	12	.40/10.2	8.0/20.4	4.0/10.2	607/2700	440	45	67
760054296	D-024-LN-5K-F12NS	24	.40/10.2	8.0/20.4	4.0/10.2	607/2700	440	45	67
760054312	D-048-LN-5K-F12NS	48	.40/10.2	8.0/20.4	4.0/10.2	607/2700	440	45	67
760054338	D-072-LN-5K-F12NS	72	.42/10.6	8.3/21.2	4.2/10.6	607/2700	440	49	73
760054163	D-006-LN-5L-F06NS	6	.40/10.2	8.0/20.4	4.0/10.2	607/2700	440	45	67
760054171	D-012-LN-5L-F12NS	12	.40/10.2	8.0/20.4	4.0/10.2	607/2700	440	45	67
760054189	D-024-LN-5L-F12NS	24	.40/10.2	8.0/20.4	4.0/10.2	607/2700	440	45	67
760054205	D-048-LN-5L-F12NS	48	.40/10.2	8.0/20.4	4.0/10.2	607/2700	440	45	67
760054221	D-072-LN-5L-F12NS	72	.42/10.6	8.3/21.2	4.2/10.6	607/2700	440	49	73
760054056	D-006-LN-5M-F06NS	6	.40/10.2	8.0/20.4	4.0/10.2	607/2700	440	45	67
760054064	D-012-LN-5M-F12NS	12	.40/10.2	8.0/20.4	4.0/10.2	607/2700	440	45	67
760054072	D-024-LN-5M-F12NS	24	.40/10.2	8.0/20.4	4.0/10.2	607/2700	440	45	67
760054098	D-048-LN-5M-F12NS	48	.40/10.2	8.0/20.4	4.0/10.2	607/2700	440	45	67
760054114	D-072-LN-5M-F12NS	72	.42/10.6	8.3/21.2	4.2/10.6	607/2700	440	49	73
760053835	D-006-LN-8W-F06NS	6	.40/10.2	8.0/20.4	4.0/10.2	607/2700	440	45	67
760053843	D-012-LN-8W-F12NS	12	.40/10.2	8.0/20.4	4.0/10.2	607/2700	440	45	67
760053850	D-024-LN-8W-F12NS	24	.40/10.2	8.0/20.4	4.0/10.2	607/2700	440	45	67
760053876	D-048-LN-8W-F12NS	48	.40/10.2	8.0/20.4	4.0/10.2	607/2700	440	45	67
760053892	D-072-LN-8W-F12NS	72	.42/10.6	8.3/21.2	4.2/10.6	607/2700	440	49	73
760053918	D-144-LN-8W-F12NS	144	.62/15.8	12.4/31.6	6.2/15.8	607/2700	440	107	160
760053926	D-288-LN-8W-F12NS	288	.71/18.2	14.3/36.4	7.1/18.2	607/2700	440	122	182
760053942	D-006-LN-6F-F06NS	6	.40/10.2	8.0/20.4	4.0/10.2	607/2700	440	45	67
760053959	D-012-LN-6F-F12NS	12	.40/10.2	8.0/20.4	4.0/10.2	607/2700	440	45	67
760053967	D-024-LN-6F-F12NS	24	.40/10.2	8.0/20.4	4.0/10.2	607/2700	440	45	67
760053983	D-048-LN-6F-F12NS	48	.40/10.2	8.0/20.4	4.0/10.2	607/2700	440	45	67
760054007	D-072-LN-6F-F12NS	72	.42/10.6	8.3/21.2	4.2/10.6	607/2700	440	49	73
760054023	D-144-LN-6F-F12NS	144	.62/15.8	12.4/31.6	6.2/15.8	607/2700	440	107	160
760054031	D-288-LN-6F-F12NS	288	.71/18.2	14.3/36.4	7.1/18.2	607/2700	440	122	182

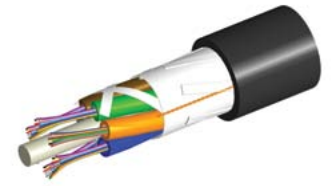

All Dry Outside Stranded Loose Tube Armored Gel-free Buffer Tube Cables

MATERIAL ID	PRODUCT NUMBER	FIBER COUNT	OUTER DIAMETER inch/mm	MIN. BEND RADIUS		MAX. TENSILE LOAD lbs./Newton	CRUSH RESISTANCE	WEIGHT	
				LOADED inch/cm	UNLOADED inch/cm			lbs. / 1000'	kg/ 1000'
760053728	D-006-LA-5K-F06NS	6	.46/11.6	9.1/23.2	4.6/11.6	607/2700	440	83	124
760053736	D-012-LA-5K-F12NS	12	.46/11.6	9.1/23.2	4.6/11.6	607/2700	440	83	124
760053744	D-024-LA-5K-F12NS	24	.46/11.6	9.1/23.2	4.6/11.6	607/2700	440	83	124
760053769	D-048-LA-5K-F12NS	48	.46/11.6	9.1/23.2	4.6/11.6	607/2700	440	83	124
760053785	D-072-LA-5K-F12NS	72	.47/12.1	9.5/24.2	4.7/12.1	607/2700	440	88	131
760053611	D-006-LA-5L-F06NS	6	.46/11.6	9.1/23.2	4.6/11.6	607/2700	440	83	124
760053629	D-012-LA-5L-F12NS	12	.46/11.6	9.1/23.2	4.6/11.6	607/2700	440	83	124
760053637	D-024-LA-5L-F12NS	24	.46/11.6	9.1/23.2	4.6/11.6	607/2700	440	83	124
760053652	D-048-LA-5L-F12NS	48	.46/11.6	9.1/23.2	4.6/11.6	607/2700	440	83	124
760053678	D-072-LA-5L-F12NS	72	.47/12.1	9.5/24.2	4.7/12.1	607/2700	440	88	131
760053504	D-006-LA-5M-F06NS	6	.46/11.6	9.1/23.2	4.6/11.6	607/2700	440	83	124
760053512	D-012-LA-5M-F12NS	12	.46/11.6	9.1/23.2	4.6/11.6	607/2700	440	83	124
760053520	D-024-LA-5M-F12NS	24	.46/11.6	9.1/23.2	4.6/11.6	607/2700	440	83	124
760053546	D-048-LA-5M-F12NS	48	.46/11.6	9.1/23.2	4.6/11.6	607/2700	440	83	124
760053561	D-072-LA-5M-F12NS	72	.47/12.1	9.5/24.2	4.7/12.1	607/2700	440	88	131
760053272	D-006-LA-8W-F06NS	6	.46/11.6	9.1/23.2	4.6/11.6	607/2700	440	83	124
760053280	D-012-LA-8W-F12NS	12	.46/11.6	9.1/23.2	4.6/11.6	607/2700	440	83	124
760053298	D-024-LA-8W-F12NS	24	.46/11.6	9.1/23.2	4.6/11.6	607/2700	440	83	124
760053314	D-048-LA-8W-F12NS	48	.46/11.6	9.1/23.2	4.6/11.6	607/2700	440	83	124
760053330	D-072-LA-8W-F12NS	72	.47/12.1	9.5/24.2	4.7/12.1	607/2700	440	88	131
760053355	D-144-LA-8W-F12NS	144	.68/17.3	13.6/34.6	6.8/17.3	607/2700	440	164	244
760053363	D-288-LA-8W-F12NS	288	.77/19.7	15.5/39.4	7.7/19.7	607/2700	440	187	279
760053389	D-006-LA-6F-F06NS	6	.46/11.6	9.1/23.2	4.6/11.6	607/2700	440	83	124
760053397	D-012-LA-6F-F12NS	12	.46/11.6	9.1/23.2	4.6/11.6	607/2700	440	83	124
760053405	D-024-LA-6F-F12NS	24	.46/11.6	9.1/23.2	4.6/11.6	607/2700	440	83	124
760053421	D-048-LA-6F-F12NS	48	.46/11.6	9.1/23.2	4.6/11.6	607/2700	440	83	124
760053447	D-072-LA-6F-F12NS	72	.47/12.1	9.5/24.2	4.7/12.1	607/2700	440	88	131
760053470	D-144-LA-6F-F12NS	144	.68/17.3	13.6/34.6	6.8/17.3	607/2700	440	164	244
760053488	D-288-LA-6F-F12NS	288	.77/19.7	15.5/39.4	7.7/19.7	607/2700	440	187	279



SYSTIMAX 360G2 Modular Fiber Shelves & Panels 1U, 2U & 4U

MATERIAL ID	PRODUCT NUMBER	DESCRIPTION
760173690	360G2-4U-MOD-UHD	360G2 4U Sliding Shelf, accepts 24 modules
760173682	360G2-2U-MOD-UHD	360G2 2U Sliding Shelf, accepts 12 modules
760173674	360G2-1U-MOD-UHD	360G2 1U Sliding Shelf, accepts 4 modules
760193870	360G2-4U-MOD-FX	360G2 4U Fixed modular cassette shelf, accepts 12 360DM, 360DP or 360G2 modular cassettes
760193888	360G2-4U-MOD-FX-16	360G2 4U Fixed modular cassette shelf, accepts 16 360DM, 360DP or 360G2 modular cassettes
760193896	360G2-4U-MOD-SD	360G2 4U Sliding modular cassette shelf, accepts 12 360DM, 360DP or 360G2 modular cassettes
760193847	360G2-2U-MOD-FX	360G2 2U Fixed modular cassette shelf, accepts 8 360DM, 360DP or 360G2 modular cassettes
760193854	360G2-2U-MOD-SD	360G2 2U Sliding modular cassette shelf, accepts 8 360DM, 360DP or 360G2 modular cassettes
760193763	360G2-1U-MOD-FX	360G2 1U Fixed modular cassette shelf, accepts 4 360DM, 360DP or 360G2 modular cassettes
760193771	360G2-1U-MOD-SD	360G2 1U Sliding modular cassette shelf, accepts 4 360DM, 360DP or 360G2 modular cassettes
760193904	360G2-1U-MOD-IS	360G2 1U Fixed modular cassette shelf, accepts 4 360DM, 360DP or 360G2 modular cassettes
760193821	360G2-1U-UP-FX	SYSTIMAX 360G2 1U faceplate shelf
760193839	360G2-1U-UP-SD	SYSTIMAX 360G2 1U sliding shelf
760193755	360MP-1U-PANEL	1U Panel, accepts 4 360DM or 360DP components
760193920	360MP-2U-PANEL	2U Panel, accepts 8 360DM or 360DP components
760193862	360MP-4U-PANEL	4U Panel, accepts 16 360DM or 360DP components
760113001	360MP-1UA	Angled 360MP 1U Panel Angled, accepts 4 360DM or 360DP components

SYSTIMAX 360G2 Accessories

MATERIAL ID	PRODUCT NUMBER	DESCRIPTION
760193938	360G2-1U-TROUGH	360 1U Trough Assembly Kit
760193946	360G2-2U-TROUGH	360 2U Trough Assembly Kit
760101410	360G2-4U-FLK	360 Flip Label Kit, 4U Shelf
760105676	360G2-1U-LABEL	360G2 Flip Label Kit, 1U Trough
760110098	CMB-360MP-1U	Hardware kit for 360MP-1U and 360MP-1U-ANGLED panels for mounting to "L" shaped equipment rail



InstaPATCH 360 Modules

MATERIAL ID	PRODUCT NUMBER	DESCRIPTION	iPatch READY
760109884	360DM-24LC-LS	InstaPATCH 360 Module, 24LC-LazrSPEED	Yes
760109892	360DM-24LC-SM	InstaPATCH 360 Module, 24LC-TeraSPEED	Yes
760109900	360DM-24LC-MM	InstaPATCH 360 Module, 24LC-OptiSPEED	Yes
760109918	360DM-24LCA-SM	InstaPATCH 360 Module, 24LCA-TeraSPEED	No
760109926	360DM-12LC-LS	InstaPATCH 360 Module, 12LC-LazrSPEED	Yes
760109934	360DM-12LC-SM	InstaPATCH 360 Module, 12LC-TeraSPEED	Yes
760109942	360DM-12LC-MM	InstaPATCH 360 Module, 12LC-OptiSPEED	Yes
760109959	360DM-12LCA-SM	InstaPATCH 360 Module, 12LCA-TeraSPEED	Yes
760109967	360DM-12SC-LS	InstaPATCH 360 Module, 12SC-LazrSPEED	No
760109975	360DM-12SC-SM	InstaPATCH 360 Module, 12SC-TeraSPEED	No
760109983	360DM-12SC-MM	InstaPATCH 360 Module, 12SC-OptiSPEED	No
760109991	360DM-12SCA-SM	InstaPATCH 360 Module, 12SCA-TeraSPEED	No



SYSTIMAX 360G2 Modular Cartridges with Pigtails

MATERIAL ID	PRODUCT NUMBER	DESCRIPTION	COLOR
760109470	360G2 Cartridge 12-LC-LS-AQ-Pigtails	w/Pigtails, 360G2 Cartridge 12 LC LazrSPEED, iPatch Ready	Aqua
760109488	360G2 Cartridge 12-LC-MM-BG-Pigtails	360G2 Cartridge 12 LC OptiSPEED, w/Pigtails, iPatch Ready	Beige
760109496	360G2 Cartridge 12-LC-SM-BL-Pigtails	360G2 Cartridge 12 LC TeraSPEED, w/Pigtails, iPatch Ready	Blue
760109504	360G2 Cartridge 12-LCA-SM-GR-Pigtails	360G2 Cartridge 12 LCA TeraSPEED, w/Pigtails, iPatch Ready	Green
760109512	360G2 Cartridge 6-SC-LS-AQ-Pigtails A	360G2 Cartridge 6 SC LazrSPEED, w/Pigtails A	Aqua
760109520	360G2 Cartridge 6-SC-LS-AQ-Pigtails B	360G2 Cartridge 6 SC LazrSPEED, w/Pigtails B	Aqua
760109538	360G2 Cartridge 6-SC-MM-BG-Pigtails A	360G2 Cartridge 6 SC OptiSPEED, w/Pigtails A	Beige
760109546	360G2 Cartridge 6-SC-MM-BG-Pigtails B	360G2 Cartridge 6 SC OptiSPEED, w/Pigtails B	Beige
760109553	360G2 Cartridge 6-SC-SM-BL-Pigtails A	360G2 Cartridge 6 SC TeraSPEED, w/Pigtails A	Blue
760109561	360G2 Cartridge 6-SC-SM-BL-Pigtails B	360G2 Cartridge 6 SC TeraSPEED, w/Pigtails B	Blue
760109579	360G2 Cartridge 6-SCA-SM-GR-Pigtails A	360G2 Cartridge 6 SCA TeraSPEED, w/Pigtails A	Green
760109587	360G2 Cartridge 6-SCA-SM-GR-Pigtails B	360G2 Cartridge 6 SCA TeraSPEED, w/Pigtails B	Green
760109603	360G2 Cartridge 6-ST-LS-AQ-Pigtails A	360G2 Cartridge 6 ST LazrSPEED, w/Pigtails A	Aqua
760109611	360G2 Cartridge 6-ST-LS-AQ-Pigtails B	360G2 Cartridge 6 ST LazrSPEED, w/Pigtails B	Aqua
760109629	360G2 Cartridge 6-ST-MM-BG-Pigtails A	360G2 Cartridge 6 ST OptiSPEED, w/Pigtails A	Beige
760109637	360G2 Cartridge 6-ST-MM-BG-Pigtails B	360G2 Cartridge 6 ST OptiSPEED, w/Pigtails B	Beige
760109645	360G2 Cartridge 6-ST-SM-BL-Pigtails A	360G2 Cartridge 6 ST TeraSPEED, w/Pigtails A	Blue
760109652	360G2 Cartridge 6-ST-SM-BL-Pigtails B	360G2 Cartridge 6 ST TeraSPEED, w/Pigtails B	Blue
760109462	360G2-MOD-BLANK-4PK	360G2 Mod Panel Blank (4 Panels)	

SYSTIMAX 360G2 Modular Cartridges without Pigtails

MATERIAL ID	PRODUCT NUMBER	DESCRIPTION	COLOR
760109256	360G2 Cartridge 12-LC-LS-AQ	360G2 Cartridge 12 LC LazrSPEED, iPatch Ready	Aqua
760109264	360G2 Cartridge 12-LC-MM-BG	360G2 Cartridge 12 LC OptiSPEED, iPatch Ready	Beige
760109272	360G2 Cartridge 12-LC-SM-BL	360G2 Cartridge 12 LC TeraSPEED, iPatch Ready	Blue
760109280	360G2 Cartridge 12-LCA-SM-GR	360G2 Cartridge 12 LCA TeraSPEED, iPatch Ready	Green
760109298	360G2 Cartridge 6-SC-LS-AQ	360G2 Cartridge 6 SC LazrSPEED	Aqua
760109306	360G2 Cartridge 6-SC-MM-BG	360G2 Cartridge 6 SC OptiSPEED	Beige
760109314	360G2 Cartridge 6-SC-SM-BL	360G2 Cartridge 6 SC TeraSPEED	Blue
760109322	360G2 Cartridge 6-SCA-SM-GR	360G2 Cartridge 6 SCA TeraSPEED	Green
760109330	360G2 Cartridge 6-ST-LS-AQ	360G2 Cartridge 6 ST LazrSPEED	Aqua
760109348	360G2 Cartridge 6-ST-MM-BG	360G2 Cartridge 6 ST OptiSPEED	Beige
760109355	360G2 Cartridge 6-ST-SM-BL	360G2 Cartridge 6 ST TeraSPEED	Blue



SYSTIMAX 360G2 Modular Distribution Panels

MATERIAL ID	PRODUCT NUMBER	DESCRIPTION
760115907	360DP-24LC-LS	360 Distribution Panel 24 LC LazrSPEED, iPatch Ready
760115923	360DP-24LC-MM	360 Distribution Panel 24 LC OptiSPEED, iPatch Ready
760115915	360DP-24LC-SM	360 Distribution Panel 24 LC TeraSPEED, iPatch Ready
760115931	360DP-24LCA-SM	360 Distribution Panel 24 LCA TeraSPEED
760109363	360DP-12LC-LS	360 Distribution Panel 12 LC LazrSPEED, iPatch Ready
760109371	360DP-12LC-MM	360 Distribution Panel 12 LC OptiSPEED, iPatch Ready
760109389	360DP-12LC-SM	360 Distribution Panel 12 LC TeraSPEED, iPatch Ready
760109751	360DP-12LCA-SM	360 Distribution Panel 12 LCA TeraSPEED, iPatch Ready
760109397	360DP-6SC-LS	360 Distribution Panel 6 SC LazrSPEED
760109405	360DP-6SC-MM	360 Distribution Panel 6 SC OptiSPEED
760109413	360DP-6SC-SM	360 Distribution Panel 6 SC TeraSPEED
760109769	360DP-6SCA-SM	360 Distribution Panel 6 SCA TeraSPEED
760109421	360DP-6ST-LS	360 Distribution Panel 6 ST LazrSPEED
760109439	360DP-6ST-MM	360 Distribution Panel 6 ST OptiSPEED
760109447	360DP-6ST-SM	360 Distribution Panel 6 ST TeraSPEED
760107490	360DP-2MPO	360 Distribution Panel 2 MPO
760107508	360DP-4MPO	360 Distribution Panel 4 MPO
760107516	360DP-6MPO	360 Distribution Panel 6 MPO
760107524	360DP-8MPO	360 Distribution Panel 8 MPO, iPatch Ready

Fiber Optic Patch Cords Configurator

1	2	3	4	5	6	7	8	9	10	11	12	13	14-16
F	D	X	L	1	L	1	2	1	-	M	X	F	010

Prefix

FD Jumper-Plenum
FE Jumper-Rise
FF Jumper-LSZH

Fiber Type

X LazrSPEED 550/Multimode
M OptiSPEED Multimode
W TeraSPEED Single-mode

Connector One

LC LC Standard
SC SC Standard
ST STII
LA LC Angled
SA SC Angled
L1 LC Keyed Red
L2 LC Keyed Yellow
L3 LC Keyed Blue
L4 LC Keyed Green
L5 LC Keyed Orange
L6 LC Keyed Slate
L7 LC Keyed Brown
L8 LC Keyed Aqua
L9 LC Keyed Rose
LV LC Keyed Violet
LU LC Uniboot

Connector Two

LC LC Standard
SC SC Standard
ST STII
LA LC Angled
SA SC Angled
L1 LC Keyed Red
L2 LC Keyed Yellow
L3 LC Keyed Blue
L4 LC Keyed Green
L5 LC Keyed Orange
L6 LC Keyed Slate
L7 LC Keyed Brown
L8 LC Keyed Aqua
L9 LC Keyed Rose
LV LC Keyed Violet
MJ MTRJ
FC FC Standard
FA FC Angled
LU LC Uniboot

Fiber Count

1 1 Fiber
2 2 Fiber

Cordage Size

2 1.6mm Simplex
3 3.0mm Simplex
4 1.6mm Zipcord
5 3.0mm Zipcord
6 2.0mm MP IC*

Jacket Color

A Blue
B Orange
C Green
D Brown
E Slate
G Red
H Black
J Yellow
K Violet
L Rose
M Aqua

UOM

F Feet
M Meter

Breakout Length

X No Breakout

Length

2 - 999 Feet
1 - 999 Meters

* This for use on Uniboot Connector Assemblies only

Cord Color Options: 1=BK (Black), 2=LB (Light Blue), 3=DG (Dark Gray), 4=GN (Spring Green), 6=OR (Orange), 7=RD (Red), 8=WH (White), 9=YL (Yellow), B=L (Lilac), C=SL (Slate), Z=BL (Blue)

Fiber Optic Pigtails Configurator

1	2	3	4	5	6	7	8	9	10	11	12	13	14-16
F	A	X	L	C	U	C	0	1	-	M	X	F	002

Prefix

FA Pigtail Tight Buffer

FB Pigtail-Riser SBJ

FC Pigtail-LSZH SBJ

Fiber Type

X LazrSPEED 550 Multimode

M OptiSPEED Multimode

W TeraSPEED Single-mode

Connector One

L1 LC Keyed Red

L2 LC Keyed Yellow

L3 LC Keyed Blue

L4 LC Keyed Green

L5 LC Keyed Orange

L6 LC Keyed Slate

L7 LC Keyed Brown

L8 LC Keyed Aqua

L9 LC Keyed Rose

LV LC Keyed Violet

LA LC Angled

LC LC Standard

LU LC Uniboot*

SA SC Angled

SC SC Standard

ST STII

FA FC Angled

FC FC Standard

Connector Two

UC Unconnectorized

Cordage Size

0 0.9mm (Tight Buffered Fiber) BTW

1 0.9mm (SBJ) Cordage

Fiber Count

1 1 Fiber

A 6 Fiber Pigtail Kit BL-WH (1-6)

B 6 Fiber Pigtail Kit RD-AQ (7-12)

C 12 Fiber Pigtail Kit BL-AQ (1-12)

Jacket Color

A Blue

B Orange

C Green

D Brown

E Slate

G Red

H Black

J Yellow

K Violet

L Rose

M Aqua

X KIT Pigtail

UOM

F Feet

M Meter

Breakout Length

X No Breakout

Length

1 - 23 Feet

1 - 7 Meters

*Only Available in EMEA
Not all combination are available. Call for details.

Trunk Cables and Trunk Extensions

InstaPATCH® 360 Trunk Cables and Trunk Extension Configurator

1	2	3	4	5	6	7	8	9	10	11	12	13	14-16
F	G	X	M	P	M	P	A	D	-	M	A	F	010

Prefix

FG Trunk-Plenum

FH Trunk-Plenum Armored

FJ Trunk-LSZH

FK Trunk-LSZH Armored

Fiber Type

X LazrSPEED 550 Multimode

Z LazrSPEED 300 Multimode

H LazrSPEED 150 Multimode

M OptiSPEED Multimode

W TeraSPEED Single-mode

Connector One

MP MPO (Female No Pins)

Connector Two

MP MPO (Female No Pins)

MX MPO (Male Pins)

Cordage Size

A 12 Fiber PmP Cable

D 12 Fiber PmP 1/0 Cable (LSZH Only)

Fiber Count

D 12 Fiber

F 24 Fiber

G 36 Fiber

H 48 Fiber

K 72 Fiber

L 96 Fiber

M 144 Fiber

Jacket Color

A Blue

B Orange

C Green

D Brown

E Slate

G Red

H Black

J Yellow

K Violet

L Rose

M Aqua

UOM

F Feet

M Meter

Breakout Length

A No Gland

B With Gland

C Pulling Grip

Length

10 - 999 Feet

3 - 999 Meters

- OptiSPEED standard is Slate
- TeraSPEED standard is Yellow
- LazrSPEED standard is Aqua

InstaPATCH® 360 Ruggedized Fanout Cable Configurator

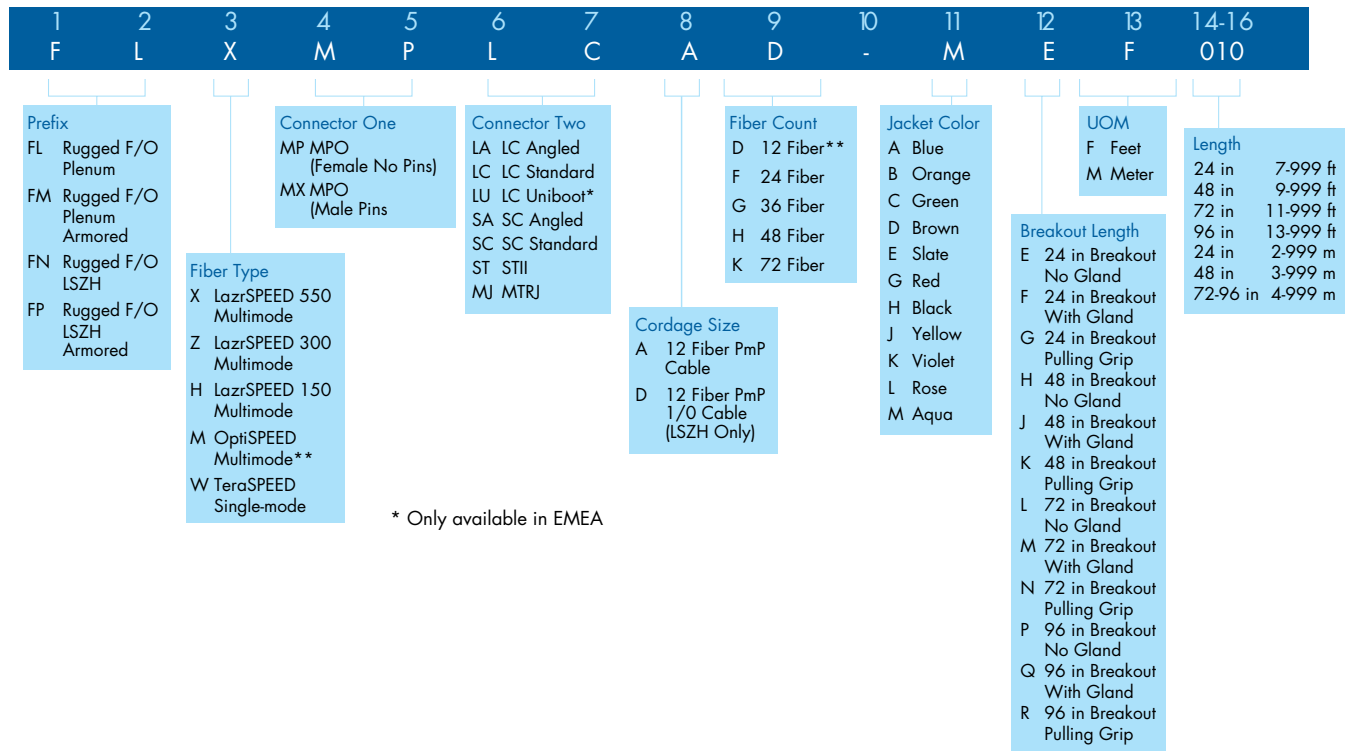

InstaPATCH® 360 Array Fanout Cables

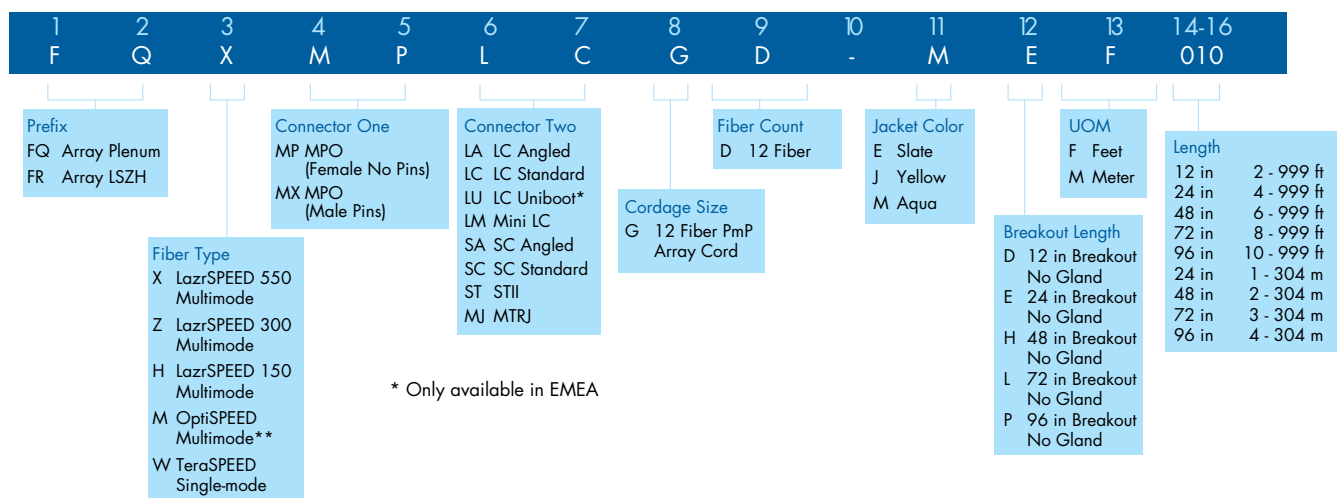

InstaPATCH® 360 Array Cords Configurator

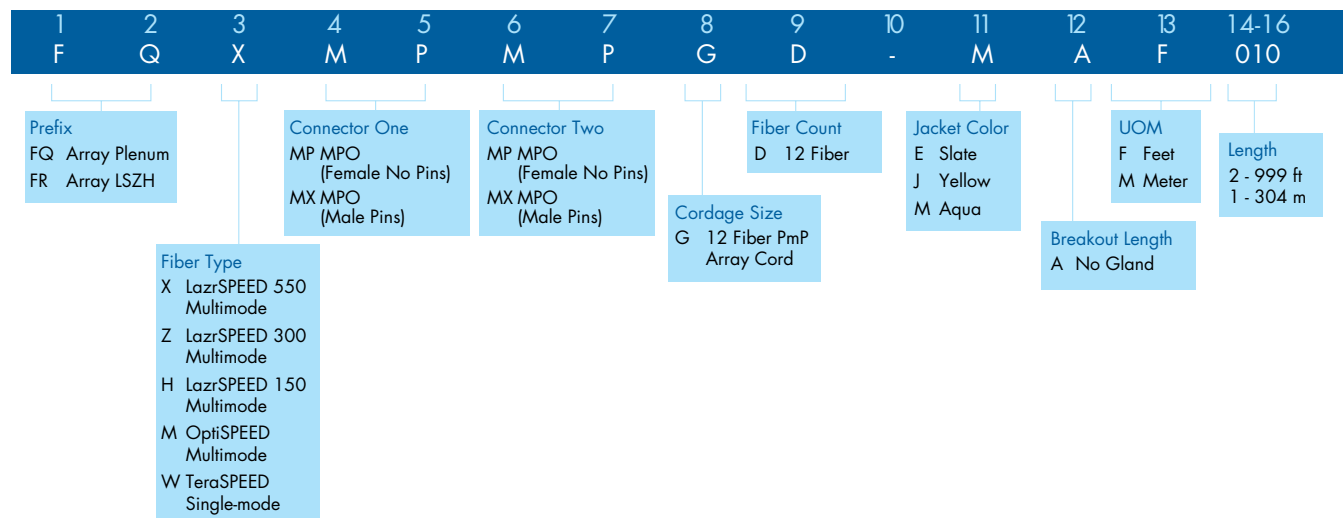



EZ-LC Connectors®

MATERIAL ID	PRODUCT NUMBER	DESCRIPTION	FIBER TYPE	COLOR	QTY./PKG.
760034181	MFC-LCR-09-BG	BTW LC Connector, Pre-radiused, for 0.9mm Fiber	MM	Beige	1
760034199	SFC-LCR-09-BL	BTW LC Connector, Pre-radiused, for 0.9mm Fiber	SM	Blue	1
760034140	MFC-LCR-16-BG	LC Connector, Pre-radiused, Simplex, for 1.6mm Cordage	MM	Beige	1
760111476	MFC-LCR-30-BG	LC Connector, Pre-radiused, Simplex, for 3.0mm Cordage	MM	Beige	1
760034173	SFC-LCR-16-BL	LC Connector, Pre-radiused, Simplex, for 1.6mm Cordage	SM	Blue	1
760111492	SFC-LCR-30-BL	LC Connector, Pre-radiused, Simplex, for 3.0mm Cordage	SM	Blue	1
760034157	MDC-LCR-16-BG	LC Connector, Pre-radiused, Duplex, for 1.6mm Cordage	MM	Beige	2
760111518	MDC-LCR-30-BG	LC Connector, Pre-radiused, Duplex, for 3.0mm Cordage	MM	Beige	2
760091439	SDC-LCR-16-BL	LC Connector, Pre-radiused, Duplex, for 1.6mm Cordage	SM	Blue	2
760111534	SDC-LCR-30-BL	LC Connector, Pre-radiused, Duplex, for 3.0mm Cordage	SM	Blue	2

EZ-SC Connectors®



MATERIAL ID	PRODUCT NUMBER	DESCRIPTION	FIBER TYPE	COLOR	QTY./PKG.
760007070	MFC-SCR-09-BG	BTW SC Connector, Pre-radiused, for 0.9mm Fiber	MM	Beige	1
760007112	SFC-SCR-09-BL	BTW SC Connector, Pre-radiused, for 0.9mm Fiber	SM	Blue	1
760112227	MFC-SCR-16-BG	SC Connector, Pre-radiused, Simplex, for 1.6mm Cordage	MM	Beige	1
760007047	MFC-SCR-30-BG	SC Connector, Pre-radiused, Simplex, for 3.0mm Cordage	MM	Beige	1
760112243	SFC-SCR-16-BL	SC Connector, Pre-radiused, Simplex, for 1.6mm Cordage	SM	Blue	1
760007096	SFC-SCR-30-BL	SC Connector, Pre-radiused, Simplex, for 3.0mm Cordage	SM	Blue	1
760112268	MDC-SCR-16-BG	SC Connector, Pre-radiused, Duplex, for 1.6mm Cordage	MM	Beige	2
760112284	MDC-SCR-30-BG	SC Connector, Pre-radiused, Duplex, for 3.0mm Cordage	MM	Beige	2
760112300	SDC-SCR-16-BL	SC Connector, Pre-radiused, Duplex, for 1.6mm Cordage	SM	Blue	2
760112326	SDC-SCR-30-BL	SC Connector, Pre-radiused, Duplex, for 3.0mm Cordage	SM	Blue	2



EZ-ST Connectors®

MATERIAL ID	PRODUCT NUMBER	DESCRIPTION	FIBER TYPE		QTY./PKG.
700004328	MFC-STU	ST II Connector, Pre-radiused	MM	0.9/2.4/3.0	1
700004310	MFC-STU-100-BULK	ST II Connector, Pre-radiused	MM	0.9/2.4/3.0	100
700011067	SFC-STU	ST II Connector, Pre-radiused	SM	0.9/2.4/3.0	1
760113241	SFC-STU-100-BULK	ST II Connector, Pre-radiused	SM	0.9/2.4/3.0	100



QWIK Connectors® II

MATERIAL ID	PRODUCT NUMBER	DESCRIPTION
760117887	MFC-LCF-09-5X	QWIK II-LC BTW Connector, LazrSPEED
760117903	MFC-LCF-09-6X	QWIK II-LC BTW Connector, OptiSPEED
760117945	MFC-SCF-09-5X	QWIK II-SC BTW Connector, LazrSPEED
760117960	MFC-SCF-09-6X	QWIK II-SC BTW Connector, OptiSPEED
760118000	MFC-STF-09-5X	QWIK II-ST BTW Connector, LazrSPEED
760118026	MFC-STF-09-6X	QWIK II-ST BTW Connector, OptiSPEED
760117895	SFC-LCF-09-8X	QWIK II-LC BTW Connector, TeraSPEED
760184697	SFC-LCF-09-8A	QWIK II-LC/APC BTW Connector, TeraSPEED
760117952	SFC-SCF-09-8X	QWIK II-SC BTW Connector, TeraSPEED
760184689	SFC-SCF-09-8A	QWIK II-SC/APC BTW Connector, TeraSPEED
760118018	SFC-STF-09-8X	QWIK II-ST BTW Connector, TeraSPEED



LC Adapters

MATERIAL ID	PRODUCT NUMBER	DESCRIPTION	COLOR	QTY./PKG.
108622887	MFA-LC02-AQ	LC Adapter, Duplex, LazrSPEED	Aqua	1
700002355	MFA-LC02-BG	LC Adapter, Duplex, OptiSPEED	Beige	1
700002215	SFA-LC02-BL	LC Adapter, Duplex, TeraSPEED	Blue	1
760036301	AFA-LC02-GR	LC Adapter, Duplex, APC	Green	1
760025338	MFA-LC01-AQ	LC Adapter, Simplex, LazrSPEED	Aqua	1
700002173	MFA-LC01-BG	LC Adapter, Simplex, OptiSPEED	Beige	1
700002132	SFA-LC01-BL	LC Adapter, Simplex, TeraSPEED	Blue	1
760036293	AFA-LC01-GR	LC Adapter, Simplex, APC	Green	1



SC Adapters

MATERIAL ID	PRODUCT NUMBER	DESCRIPTION	COLOR	QTY./PKG.
108622895	MFA-SC02-AQ	SC Adapter, Duplex, LazrSPEED	Aqua	1
700004880	MFA-SC02-BG	SC Adapter, Duplex, OptiSPEED	Beige	1
700004815	SFA-SC02-BL	SC Adapter, Duplex, TeraSPEED	Blue	1
760036285	AFA-SC02-GR	SC Adapter, Duplex, APC	Green	1
760115543	MFA-SC01-AQ	SC Adapter, Simplex, LazrSPEED	Aqua	1
108223181	MFA-SC01-BG	SC Adapter, Simplex, OptiSPEED	Beige	1
700004807	SFA-SC01-BL	SC Adapter, Simplex, TeraSPEED	Blue	1
760036277	AFA-SC01-GR	SC Adapter, Simplex, APC	Green	1



ST Adapters

MATERIAL ID	PRODUCT NUMBER	DESCRIPTION	FIBER TYPE	QTY./PKG.
700011133	HFA-ST01	Hybrid ST Adapter, Hex Nut	SM	1
760000638	HFA-ST01-CMN	Hybrid ST Adapter, Circular Nut	SM	1



Straight Sections

MATERIAL ID	DESCRIPTION
SRS-STMN-NUNU-YL-F	Straight Solid Channel, Yellow, 300mm x 100mm
SRS-STCV-NUNU-YL-F	Straight Snap-on Cover, Yellow, 300mm x 100mm
SRS-STKT-NUNU-YL-F	Straight Solid Channel with Cover, Yellow, 300mm x 100mm
SRS-STMN-NUNU-YL-B	Straight Solid Channel, Yellow, 220mm x 100mm
SRS-STCV-NUNU-YL-B	Straight Snap-on Cover, Yellow, 220mm x 100mm
SRS-STHV-NUNU-YL-B	Straight Hinged Cover, Yellow, 220mm x 100mm
SRS-STKT-NUNU-YL-B	Straight Solid Channel with Cover, Yellow, 220mm x 100mm
SRS-STHT-NUNU-YL-B	Straight Solid Channel with Hinged Cover, Yellow, 220mm x 100mm
SRS-STMN-NUNU-YL-A	Straight Solid Channel, Yellow, 100mm x 100mm
SRS-STMN-SLNU-YL-A	Straight Slotted Channel, Yellow, 100mm x 100mm
SRS-STCV-NUNU-YL-A	Straight Snap-on Cover, Yellow, 100mm x 100mm
SRS-STHV-NUNU-YL-A	Straight Hinged Cover, Yellow, 100mm x 100mm
SRS-STKT-NUNU-YL-A	Straight Solid Channel with Cover, Yellow, 100mm x 100mm
SRS-STKT-SLNU-YL-A	Straight Slotted Channel with Cover, Yellow, 100mm x 100mm
SRS-STHT-NUNU-YL-A	Straight Solid Channel with Hinged Cover, Yellow, 100mm x 100mm
SRS-STHT-SLNU-YL-A	Straight Slotted Channel with Hinged Cover, Yellow, 100mm x 100mm
SRS-STHT-SLNU-YL-C	Straight Slotted Channel with Hinged Cover, Yellow, 50mm x 50mm



Transitional Sections

MATERIAL ID	DESCRIPTION
SRS-JOST-NUNU-YL-F	Snap-together Joiner, Yellow, 300mm x 100mm
SRS-JOST-NUNU-YL-B	Snap-together Joiner, Yellow, 220mm x 100mm
SRS-JOST-NUNU-YL-A	Snap-together Joiner, Yellow, 100mm x 100mm
SRS-ELKT-HR45-YL-F	Horizontal Elbow with Cover, 45°, Yellow, 300mm x 100mm
SRS-ELKT-HR90-YL-F	Horizontal Elbow with Cover, 90°, Yellow, 300mm x 100mm
SRS-ELKT-HR45-YL-B	Horizontal Elbow with Cover, 45°, Yellow, 220mm x 100mm
SRS-ELKT-HR90-YL-B	Horizontal Elbow with Cover, 90°, Yellow, 220mm x 100mm
SRS-ELKT-HR45-YL-A	Horizontal Elbow with Cover, 45°, Yellow, 100mm x 100mm
SRS-ELKT-HR90-YL-A	Horizontal Elbow with Cover, 90°, Yellow, 100mm x 100mm
SRS-ELKT-DN45-YL-F	Elbow with Cover, Down, 45°, Yellow, 300mm x 100mm
SRS-ELKT-DN90-YL-F	Elbow with Cover, Down, 90°, Yellow, 300mm x 100mm
SRS-ELKT-UP45-YL-F	Elbow with Cover, Up, 45°, Yellow, 300mm x 100mm
SRS-ELKT-UP90-YL-F	Elbow with Cover, Up, 90°, Yellow, 300mm x 100mm
SRS-ELKT-DN45-YL-B	Elbow with Cover, Down, 45°, Yellow, 220mm x 100mm
SRS-ELKT-DN90-YL-B	Elbow with Cover, Down, 90°, Yellow, 220mm x 100mm
SRS-ELKT-UP45-YL-B	Elbow with Cover, Up, 45°, Yellow, 220mm x 100mm
SRS-ELKT-UP90-YL-B	Elbow with Cover, Up, 90°, Yellow, 220mm x 100mm

Transitional Sections (con't)

MATERIAL ID	DESCRIPTION
SRS-ELKT-DN45-YL-A	Elbow with Cover, Down, 45°, Yellow, 100mm x 100mm
SRS-ELKT-DN90-YL-A	Elbow with Cover, Down, 90°, Yellow, 100mm x 100mm
SRS-ELKT-UP45-YL-A	Elbow with Cover, Up, 45°, Yellow, 100mm x 100mm
SRS-ELKT-UP90-YL-A	Elbow with Cover, Up, 90°, Yellow, 100mm x 100mm
SRS-TEKT-HRNU-YL-F	Tee with Cover, Horizontal, Yellow, 300mm x 100mm
SRS-TEKT-HRNU-YL-B	Tee with Cover, Horizontal, Yellow, 220mm x 100mm
SRS-TEKT-HRNU-YL-A	Tee with Cover, Horizontal, Yellow, 100mm x 100mm
SRS-CRKT-HRNU-YL-F	Cross with Cover, Horizontal, Yellow, 300mm x 100mm
SRS-CRKT-HRNU-YL-B	Cross with Cover, Horizontal, Yellow, 220mm x 100mm
SRS-CRKT-HRNU-YL-A	Cross with Cover, Horizontal, Yellow, 100mm x 100mm
SRS-TEKT-VTNU-YL-F	Tee with Cover, Vertical, Yellow, 300mm x 100mm
SRS-TEKT-VTNU-YL-B	Tee with Cover, Vertical, Yellow, 220mm x 100mm
SRS-TEKT-VTNU-YL-A	Tee with Cover, Vertical, Yellow, 100mm x 100mm
SRS-ECAP-NUNU-YL-F	End Cap, Any-point, Yellow, 300mm x 100mm
SRS-ECST-NUNU-YL-B	End Cap, Snap-together, Yellow, 220mm x 100mm
SRS-ECST-NUNU-YL-A	End Cap, Snap-together, Yellow, 100mm x 100mm
SRS-ECST-46NU-YL-A	End Cap, Snap-together, 2 x 46mm dia. holes, Yellow, 100mm x 100mm
SRS-ECST-88NU-YL-A	End Cap, Snap-together, 88mm dia. tube outlet, Yellow, 100mm x 100mm



Drop Solutions

MATERIAL ID	DESCRIPTION
760173955	Express Drop Kit, Vertical to 100mm x 100mm Snap-together Raceway, Yellow
760174912	High Capacity Break-out Kit, Vertical to 88mm tube, 2M tube included, Yellow
760174938	High Capacity Break-out Kit, Vertical to dual 88mm tube, 2 x 2M tube included, Yellow
760173997	Drop Accessories, Trumpet, 100mm, Yellow
760174714	Drop Accessories, Trumpet, 220mm, Yellow
760173971	Drop Accessories, Trumpet, 300mm, Yellow



Mounting Components

MATERIAL ID	DESCRIPTION
760184432	Trapeze Kit, 100mm x 100mm or 100mm x 50mm
760183087	Trapeze Kit, 220mm x 100mm
760184440	Trapeze Kit, 300mm x 100mm
760188466	Ladder Rack and Unistrut Mounting Kit, L-Bracket, 100mm/220mm/300mm
760174136	Mounting Hardware, Channel Mounting Bracket, 100mm
760174862	Mounting Hardware, Channel Mounting Bracket, 220mm
760174144	Mounting Hardware, Channel Mounting Bracket, 300mm



Tools and Accessories

MATERIAL ID	DESCRIPTION
760174227	Tooling, Hydraulic Hand Held Slotting Tool, 100mm, 200mm 300mm, Kit
760184481	Tooling, Cut-out Tool Kit with wrench, fiber spreader and toolbox, 150mm
760174276	Tooling, Cut-out Tool, Mitre box, 100mm, 100mmL, 220mm, 300mm
760173989	Radius Guide, 10 pk, Yellow



SYSTIMAX imVision® Controller

MATERIAL ID	PRODUCT NUMBER	DESCRIPTION
760161380	360-iMV-CNTRLR	imVision Controller
760031716	iP-POWER-SUPPLY	Spare iPatch® Power Supply

SYSTIMAX imVision® System Manager Software

See eCatalog for our full offering of System Manager software.

iPatch® Infrastructure Management

iPatch® Infrastructure Management Copper Panels



MATERIAL ID	PRODUCT NUMBER	DESCRIPTION
760201145	360-iP-1100-E-GS6-1U-24	360 iPatch 1100GS6 24-Port Evolve Patch Panel
760201129	360-iP-1100-E-GS6-2U-48	360 iPatch 1100GS6 48-Port Evolve Patch Panel
760158642	360-iP-1100A-E-GS6-1U-24	360 iPatch 1100GS6 24-Port Evolve Angled Patch Panel
760158659	360-iP-1100A-E-GS6-2U-48	360 iPatch 1100GS6 48-Port Evolve Angled Patch Panel
760201137	360-iP-1100-E-GS3-1U-24	360 iPatch 1100GS3 24-Port Evolve Patch Panel
760201111	360-iP-1100-E-GS3-2U-48	360 iPatch 1100GS3 48-Port Evolve Patch Panel
760158626	360-iP-1100A-E-GS3-1U-24	360 iPatch 1100GS3 24-Port Evolve Angled Patch Panel
760158634	360-iP-1100A-E-GS3-2U-48	360 iPatch 1100GS3 48-Port Evolve Angled Patch Panel
760104992	360-iP-UP-KIT-1100-24	360 iPatch Upgrade Kit for 360 1100 24-Port Panel, 10 pack
760105015	360-iP-UP-KIT-1100-48	360 iPatch Upgrade Kit for 360 1100 48-Port Panel, 5 pack
760198747	360-iP-UP-KIT-E-24	360 iPatch Upgrade Kit for 360 Evolve 24-Port Panel, 10 Pack
760158600	360-iP-UP-KIT-AE-24	360 iPatch Angled Evolve Kit, 24-Port, 10 pack
760158618	360-iP-UP-KIT-AE-48	360 iPatch Angled Evolve Kit, 48-Port, 5 pack
760198754	360-iP-UP-KIT-E-PMAX-48	360 iPatch Upgrade Kit for 360 Evolve and PATCHMAX 48-Port Panels, 5 Pack
760201269	360-iP-PMAX-GS6-24	360 iPatch PATCHMAX GS6 24-Port Panel
760201236	360-iP-PMAX-GS6-48	360 iPatch PATCHMAX GS6 48-Port Panel
760201244	360-iP-PMAX-GS3-24	360 iPatch PATCHMAX GS3 24-Port Panel
760201210	360-iP-PMAX-GS3-48	360 iPatch PATCHMAX GS3 48-Port Panel
760198762	360-iP-UP-KIT-PMAX-2U-24	360 iPatch Upgrade Kit, PATCHMAX 24-Port, 2U
760201152	360-iP-1100-E-1U-BLANK	360 iPatch 1100 Evolve 24 Port, blank
760201160	360-iP-1100-E-2U-BLANK	360 iPatch 1100 Evolve 48 Port, blank
760163808	360-iP-1100A-E-1U-BLANK	360 iPatch 1100 Angled Evolve 24 Port, blank
760163816	360-iP-1100A-E-2U-BLANK	360 iPatch 1100 Angled Evolve 48 Port, blank
760152371	360-iP-M-E-HD6B-1U-24	360 iPatch Evolve High Density F/UTP Modular Panel, 24-Port
760201186	360-iP-M-E-HD6B-2U-48	360 iPatch Evolve High Density F/UTP Modular Panel, 48-Port
760158667	360-iP-MFTPA-E-HD6B-1U-24	360 iPatch Evolve High Density F/UTP Angled Modular Panel, 24-Port
760158675	360-iP-MFTPA-E-HD6B-2U-48	360 iPatch Evolve High Density F/UTP Angled Modular Panel, 48-Port
760201194	360-iP-MFTP-E-1U-BLANK	360 iPatch F/UTP Evolve 24 Port Panel, blank
760201202	360-iP-MFTP-E-2U-BLANK	360 iPatch F/UTP Evolve 48 Port Panel, blank
760163824	360-iP-MFTPA-E-1U-BLANK	360 iPatch F/UTP Angled Evolve 24 Port Panel, blank
760163832	360-iP-MFTPA-E-2U-BLANK	360 iPatch F/UTP Angled Evolve 48 Port Panel, blank



iPatch® Infrastructure Management Fiber Optic Shelves

MATERIAL ID	PRODUCT NUMBER	DESCRIPTION
760193805	360-iP-INSTA-LC-4LS	360 iPatch G2 LC Fiber Shelf InstaPATCH 360 LazrSPEED® Slide
760193813	360-iP-INSTA-LC-4TS	360 iPatch G2 LC Fiber Shelf InstaPATCH 360 TeraSPEED® Slide
760193789	360-iP-G2-1U-LC-FX	360 iPatch G2 LC Fiber Shelf, Fixed
760193797	360-iP-G2-1U-LC-SD	360 iPatch G2 Fiber Shelf, Slide
760105148	360-iP-UP-KIT-G2-LC	360 iPatch Upgrade Kit for 360G2-1U-MOD shelves with LC Cassettes
760168419	360G2-iP 1U 96F LC DP SD	360G2 iPatch 1U 96F-LC Distribution Panel, Sliding Shelf
760168435	360G2-iP 1U 96F LC DM LS SD	360G2 iPatch 1U 96F-LC Distribution Module, LazrSPEED, Sliding Shelf
760188326	360G2-iP 1U 96F LC DM TS SD	360G2 iPatch 1U 96F-LC Distribution Module, TeraSPEED, Sliding Shelf
760188342	360G2-iP 1U 96F LC DM LS UHD	360G2 iPatch 1U 96F-LC Distribution Module, LazrSPEED, UHD Shelf
760188359	360G2-iP 1U 96F LC DM TS UHD	360G2 iPatch 1U 96F-LC Distribution Module, TeraSPEED, UHD Shelf
760188375	360G2-iP 2U 192F LC DP SD	360G2 iPatch 2U 192F-LC Distribution Panel, Sliding Shelf
760188383	360G2-iP 2U 192F LC DM LS SD	360G2 iPatch 2U 192F-LC Distribution Module, LazrSPEED, Sliding Shelf
760188391	360G2-iP 2U 192F LC DM TS SD	360G2 iPatch 2U 192F-LC Distribution Module, TeraSPEED, Sliding Shelf
760188417	360G2-iP 2U 288F LC DM LS UHD	360G2 iPatch 2U 288F-LC Distribution Module, LazrSPEED, UHD Shelf
760188425	360G2-iP 2U 288F LC DM TS UHD	360G2 iPatch 2U 288F-LC Distribution Module, TeraSPEED, UHD Shelf
760169144	360G2-iP 1U 32 MPO DP SD	360G2 iPatch 1U 32-MPO Distribution Panel, Sliding Shelf
760169177	360G2-iP 1U 32 MPO DP UHD	360G2 iPatch 1U 32-MPO Distribution Panel, UHD Shelf
760169185	360G2-iP 2U 64 MPO DP SD	360G2 iPatch 2U 64-MPO Distribution Panel, Sliding Shelf
760169193	360G2-iP 2U 96 MPO DP UHD	360G2 iPatch 2U 96-MPO Distribution Panel, UHD Shelf
760168443	360G2-iP 96F LC SD KIT-5PK	360G2 iPatch 96F-LC, Sliding Shelf 5PK Kit
760172221	360G2-iP 96F LC UHD KIT-6PK	360G2 iPatch 96F-LC, UHD Shelf 6PK Kit
760169151	360G2-iP 32 MPO SD KIT-5PK	360G2 iPatch 32-MPO, Sliding Shelf 5PK Kit
760169169	360G2-iP 32 MPO UHD KIT-6PK	360G2 iPatch 32-MPO, UHD Shelf 6PK Kit



SYSTIMAX 360™ iPatch® Fiber Shelves & Modules

MATERIAL ID	PRODUCT NUMBER	DESCRIPTION
760093336	360-iP-HD-2U-IP-SD	360 iPatch G2 HD Fiber Shelf, Slide
760093344	360-iP-HD-MOD-LC-LS	360 iPatch G2 HD LS Module
760093351	360-iP-HD-MOD-LC-LS-3	360 iPatch G2 HD LS Module (3-pack)
760093369	360-iP-HD-MOD-LC-TS	360 iPatch G2 HD TS Module
760093377	360-iP-HD-MOD-LC-TS-3	360 iPatch G2 HD TS Module (3-pack)
760093385	360-iP-HD-MOD-LC-OS	360 iPatch G2 HD OS Module
760093393	360-iP-HD-MOD-LC-OS-3	360 iPatch G2 HD OS Module (3-pack)



APAC Faceplates

MATERIAL ID	PRODUCT NUMBER	DESCRIPTION	COLOR
760200428	M10CF	M10CF Faceplate, 1-port	White
760200436	M12CF	M12CF Faceplate, 2-port	White
760200444	M14CF	M14CF Faceplate, 4-port	White
760200451	M12CFS	M12CFS Shuttered Faceplate, 2-port	White
760200469	M14CFS	M14CFS Shuttered Faceplate, 4-port	White

Stainless Steel Faceplates



MATERIAL ID	PRODUCT NUMBER	DESCRIPTION	COLOR
760100867	M11SP	1 Port Stainless Steel Faceplate	Stainless Steel
760072074	M11SP-L	1-Port 1-Gang SS Faceplate with label	Stainless Steel
108615188	M12SP	2 port Stainless Steel Faceplate	Stainless Steel
760072181	M12SP-L	2-Port 1-Gang SS Faceplate with label	Stainless Steel
108615196	M13SP 3	3 port Stainless Steel Faceplate	Stainless Steel
760072199	M13SP-L	3-Port 1-Gang SS Faceplate with label	Stainless Steel
108615204	M14SP 4	4 port Stainless Steel Faceplate	Stainless Steel
760072207	M14SP-L	4-Port 1-Gang SS Faceplate with label	Stainless Steel
108615212	M16SP 6	6 port Stainless Steel Faceplate	Stainless Steel
760072215	M16SP-L	6-Port 1-Gang SS Faceplate with label	Stainless Steel

Modular Outlet Wall Phone Faceplates



MATERIAL ID	PRODUCT NUMBER	DESCRIPTION	COLOR
108258443	M10LW-003	1 Port Modular Outlet Wall Phone Faceplate	Black
108258450	M10LW-246	1 Port Modular Outlet Wall Phone Faceplate	Ivory
108258427	M10LW-262	1 Port Modular Outlet Wall Phone Faceplate	White
760181750	M10LW-266	1 Port Modular Outlet Wall Phone Faceplate	ProWhite
108258476	M10LW-270	1 Port Modular Outlet Wall Phone Faceplate	Gray



Modular Flush-Mount Faceplates

MATERIAL ID	PRODUCT NUMBER	DESCRIPTION	COLOR
108168527	M13L-003	3 Port Modular Flush Mount Faceplate	Black
108168519	M13L-246	3 Port Modular Flush Mount Faceplate	Ivory
108168501	M13L-262	3 Port Modular Flush Mount Faceplate	White
760181719	M13L-266	3 Port Modular Flush Mount Faceplate	ProWhite
108168493	M13L-270	3 Port Modular Flush Mount Faceplate	Gray
108168568	M14L-003	4 Port Modular Flush Mount Faceplate	Black
108168550	M14L-246	4 Port Modular Flush Mount Faceplate	Ivory
108168543	M14L-262	4 Port Modular Flush Mount Faceplate	White
760181727	M14L-266	4 Port Modular Flush Mount Faceplate	ProWhite
108168535	M14L-270	4 Port Modular Flush Mount Faceplate	Gray
108168600	M16L-003	6 Port Modular Flush Mount Faceplate	Black
108168592	M16L-246	6 Port Modular Flush Mount Faceplate	Ivory
108168584	M16L-262	6 Port Modular Flush Mount Faceplate	White
760181735	M16L-266	6 Port Modular Flush Mount Faceplate	ProWhite
108168576	M16L-270	6 Port Modular Flush Mount Faceplate	Gray
108685009	M28L-003	8 Port Modular Flush Mount Faceplate	Black
108685017	M28L-246	8 Port Modular Flush Mount Faceplate	Ivory
108685025	M28L-262	8 Port Modular Flush Mount Faceplate	White
760181768	M28L-266	8 Port Modular Flush Mount Faceplate	ProWhite
108685033	M28L-270	8 Port Modular Flush Mount Faceplate	Gray



Modular Furniture Faceplates

MATERIAL ID	PRODUCT NUMBER	DESCRIPTION	COLOR
106650864	M13C-003	3 Port Modular Furniture Faceplate (1.84 x 3.13 x 0.29 in)	Black
106650880	M13C-246	3 Port Modular Furniture Faceplate (1.84 x 3.13 x 0.29 in)	Ivory
106650898	M13C-262	3 Port Modular Furniture Faceplate (1.84 x 3.13 x 0.29 in)	White
106701154	M13C-270	3 Port Modular Furniture Faceplate (1.84 x 3.13 x 0.29 in)	Gray
108216151	M14CE-003	4 Port Modular Furniture Faceplate (2.16 x 4.07 x 1.27 in)	Black
108216144	M14CE-246	4 Port Modular Furniture Faceplate (2.16 x 4.07 x 1.27 in)	Ivory
108216128	M14CE-262	4 Port Modular Furniture Faceplate (2.16 x 4.07 x 1.27 in)	White
108216136	M14CE-270	4 Port Modular Furniture Faceplate (2.16 x 4.07 x 1.27 in)	Gray



Designer Faceplates

MATERIAL ID	PRODUCT NUMBER	DESCRIPTION	COLOR
108332982	M10LE-003	1 Port Designer Faceplate	Black
108333006	M10LE-246	1 Port Designer Faceplate	Ivory
108333014	M10LE-262	1 Port Designer Faceplate	White
760181933	M10LE-266	1 Port Designer Faceplate	ProWhite
108333022	M10LE-270	1 Port Designer Faceplate	Gray
108333030	M12LE-003	2 Port Designer Faceplate	Black
108333055	M12LE-246	2 Port Designer Faceplate	Ivory
108333063	M12LE-262	2 Port Designer Faceplate	White
760181941	M12LE-266	2 Port Designer Faceplate	ProWhite
108333071	M12LE-270	2 Port Designer Faceplate	Gray
108333089	M13LE-003	3 Port Designer Faceplate	Black
108333105	M13LE-246	3 Port Designer Faceplate	Ivory
108333113	M13LE-262	3 Port Designer Faceplate	White
760181958	M13LE-266	3 Port Designer Faceplate	ProWhite
108333121	M13LE-270	3 Port Designer Faceplate	Gray
108333139	M14LE-003	4 Port Designer Faceplate	Black
108333154	M14LE-246	4 Port Designer Faceplate	Ivory
108333162	M14LE-262	4 Port Designer Faceplate	White
760181966	M14LE-266	4 Port Designer Faceplate	ProWhite
108333170	M14LE-270	4 Port Designer Faceplate	Gray
108333188	M16LE-003	6 Port Designer Faceplate	Black
108333204	M16LE-246	6 Port Designer Faceplate	Ivory
108333212	M16LE-262	6 Port Designer Faceplate	White
760181974	M16LE-266	6 Port Designer Faceplate	ProWhite
108333220	M16LE-270	6 Port Designer Faceplate	Gray

Flexible Adapters



MATERIAL ID	PRODUCT NUMBER	DESCRIPTION	COLOR
760009464	M30FP-Blank-003	Flexible Adapter Blank	Black
760009472	M30FP-Blank-246	Flexible Adapter Blank	Ivory
760009480	M30FP-Blank-262	Flexible Adapter Blank	White
760181800	M30FP-Blank-266	Flexible Adapter Blank	ProWhite
760009498	M30FP-Blank-270	Flexible Adapter Blank	Gray
760009423	M30FP-1RJ45-003	Flexible Adapter Single Outlet	Black
760009431	M30FP-1RJ45-246	Flexible Adapter Single Outlet	Ivory
760009449	M30FP-1RJ45-262	Flexible Adapter Single Outlet	White
760181792	M30FP-1RJ45-266	Flexible Adapter Single Outlet	ProWhite
760009456	M30FP-1RJ45-270	Flexible Adapter Single Outlet	Gray
760008649	M30FP-2RJ45-003	Flexible Adapter Double Outlet	Black
760008656	M30FP-2RJ45-246	Flexible Adapter Double Outlet	Ivory
760008664	M30FP-2RJ45-262	Flexible Adapter Double Outlet	White
760181784	M30FP-2RJ45-266	Flexible Adapter Double Outlet	ProWhite
760008672	M30FP-2RJ45-270	Flexible Adapter Double Outlet	Gray



19" Racks

MATERIAL ID	PRODUCT NUMBER	DESCRIPTION
760082479	RK3-45A	2-post aluminum rack, 3" channel, 7 ft (12-24 tapped rails)
760082487	RK3-52A	2-post aluminum rack, 3" channel, 8 ft (12-24 tapped rails)
760082495	RK6-45A	2-post aluminum rack, 6" channel, 7 ft (12-24 tapped rails)
760082503	RK6-52A	2-post aluminum rack, 6" channel, 8 ft (12-24 tapped rails)
760082511	RK12-45A	2-post aluminum rack, 12" channel, 7 ft (12-24 tapped rails)
760103010	RK3-17A	2-post aluminum rack, 3" channel, 3 ft (12-24 tapped rails)
760090118	RK3-45S	2-post steel rack, 3" channel, 7 ft (3/8 sq punched)
760090126	RK3-52S	2-post steel rack, 3" channel, 8 ft (3/8 sq punched)
760090134	RK6-45S	2-post steel rack, 6" channel, 7 ft (3/8 sq punched)
760090142	RK6-52S	2-post steel rack, 6" channel, 8 ft (3/8 sq punched)
760082529	RK4P45-29A	4-post aluminum rack, 29", 7 ft (12-24 tapped rails)
760082537	RK4P52-29A	4-post aluminum rack, 29", 8 ft (12-24 tapped rails)
760082560	RK4P45-36A	4-post aluminum rack, 36", 7 ft (12-24 tapped rails)
760082578	RK4P52-36A	4-post aluminum rack, 36", 8 ft (12-24 tapped rails)
760082545	RK4P45-29S	4-post steel rack, 29", 7 ft (3/8 sq punched)
760082552	RK4P52-29S	4-post steel rack, 29", 8 ft (3/8 sq punched)
760082586	RK4P45-36S	4-post steel rack, 36", 7 ft (3/8 sq punched)
760082594	RK4P52-36S	4-post steel rack, 36", 8 ft (3/8 sq punched)

Shelves

MATERIAL ID	PRODUCT NUMBER	DESCRIPTION
760162008	SHELF-19-2U-10	Cantilever Shelf, 19" x 2U x 10D, black
760162016	SHELF-19-2U-14	Cantilever Shelf, 19" x 2U x 14D, black
760162024	SHELF-DS-19-2U-19	Double Sided Shelf, 19" x 2U x 19D, black
760126032	SHELF-HD-DS-10-4U-26	Double Sided Heavy Duty Shelf, 19" x 2U x 26D, black
760162040	SHELF-ADJ-19-1U-24X36	Adjustable Shelf, 19" x 1U x 24-36D, black
760162057	SHELF-KEY-19-2U-8	Roll Out Keyboard Tray, 19" x 2U x 8D, black

Filler Panels

MATERIAL ID	PRODUCT NUMBER	DESCRIPTION
760162065	FPANEL-19-1U	Filler Panel, 1U x 19"
760162073	FPANEL-19-2U	Filler Panel, 2U x 19"
760162081	FPANEL-19-3U	Filler Panel, 3U x 19"



Horizontal Cable Management

MATERIAL ID	PRODUCT NUMBER	DESCRIPTION
760072942	HTK-19-SS-1U	1U 19" Single Sided Horizontal Trough Kit
760072959	HTK-19-SS-2U	2U 19" Single Sided Horizontal Trough Kit
760072967	HTK-19-SS-3U	3U 19" Single Sided Horizontal Trough Kit
760128843	HTK-19-DS-1U	1U 19" Double Sided Horizontal Trough Kit
760128850	HTK-19-DS-2U	2U 19" Double Sided Horizontal Trough Kit
760128868	HTK-19-DS-3U	3U 19" Double Sided Horizontal Trough Kit



Vertical Cable Management

MATERIAL ID	PRODUCT NUMBER	DESCRIPTION
760089342	VCM-DS-84-6B	Double Sided 6 X 84 VCM, black doors
760089359	VCM-DS-84-8B	Double Sided 8 X 84 VCM, black doors
760089367	VCM-DS-84-10B	Double Sided 10 X 84 VCM, black doors
760089375	VCM-DS-84-12B	Double Sided 12 X 84 VCM, black doors
760089425	VCM-SS-84-6B	Single Sided 6 X 84 VCM, black doors
760089433	VCM-SS-84-8B	Single Sided 8 X 84 VCM, black doors
760089441	VCM-SS-84-10B	Single Sided 10 X 84 VCM, black doors
760089458	VCM-SS-84-12B	Single Sided 12 X 84 VCM, black doors
760072785	VCM-DS-84-6	Double Sided 6 X 84 VCM, silver doors
760072793	VCM-DS-84-8	Double Sided 8 X 84 VCM, silver doors
760072801	VCM-DS-84-10	Double Sided 10 X 84 VCM, silver doors
760072819	VCM-DS-84-12	Double Sided 12 X 84 VCM, silver doors
760072868	VCM-SS-84-6	Single Sided 6 X 84 VCM, silver doors
760072876	VCM-SS-84-8	Single Sided 8 X 84 VCM, silver doors
760072884	VCM-SS-84-10	Single Sided 10 X 84 VCM, silver doors
760072892	VCM-SS-84-12	Single Sided 12 X 84 VCM, silver doors

Lined area for notes.

CommScope, (NASDAQ: COMM)

helps companies around the world design, build and manage their wired and wireless networks. Our network infrastructure solutions help customers increase bandwidth; maximize existing capacity; improve network performance and availability; increase energy efficiency; and simplify technology migration. You will find our solutions in the largest buildings, venues and outdoor spaces; in data centers and buildings of all shapes, sizes and complexity; at wireless cell sites and in cable headends; and in airports, trains, and tunnels. Vital networks around the world run on CommScope solutions.



CommScope Certified Report Systems

WebTrak® gives you on-line factory test reports for Fiber, Hybrid Fiber, Twisted Pair Cables, Cable Assemblies and Base Station Antennas.

cTrak is our latest FREE mobile app to access factory tests on the go from your iPhone or iPad. Available on iTunes.



On-line Self Paced Training Courses

Available on our website through the CommScope Infrastructure Academy.
