



SYSTIMAX Solutions®

Europe, Middle East, Africa Ordering Guide
(03/15)

Category 6A Products

SYSTIMAX 360™ GigaSPEED X10D® U/UTP Copper Cables
SYSTIMAX 360™ GigaSPEED X10D® Panels
SYSTIMAX 360™ GigaSPEED X10D® Information Outlets
SYSTIMAX 360™ GigaSPEED X10D® Patch Cords

Category 6 Products

SYSTIMAX 360™ GigaSPEED XL® Copper Cables
SYSTIMAX 360™ GigaSPEED XL® Panels
SYSTIMAX 360™ GigaSPEED XL® Information Outlets
SYSTIMAX 360™ GigaSPEED XL® Patch Cords

Category 5e Products

PowerSUM U/UTP Copper Cables
PowerSUM U/UTP Patch Panels
PowerSUM Information Outlets
PowerSUM Patch Cords

VisiPatch 360®

VisiPatch 360® Patch Panel Kits
VisiPatch 360® Cable Manager Kits
VisiPatch 360® GigaSPEED 4-pair Patch Cords
VisiPatch 360® 1-Pair Patch Cord
VisiPatch 360® to VisiPatch® GigaSPEED Hybrid Patch Cord

InstaPATCH® Cu

InstaPATCH® Cu Solutions
InstaPATCH® QUATTRO Solutions

Modular Panels

SYSTIMAX 360™ Modular Panels
M4800/M4800A 1U High Density Modular Panels
M2000 Modular Patch Panels
M2100 Modular Patch Panels

Coaxial Solutions

Video Cables
Security Cables

Fiber Solutions

Fiber Optic Cable Configurator
Single Unit Distribution Cables
Multi Unit Distribution Cables
Distribution Cables
Indoor/Outdoor Cables
Outside Plant Cables

Fiber Connectivity

SYSTIMAX 360G2
 SYSTIMAX 360G2 Modular Fiber Shelves & Panels 1U, 2U & 4U
 SYSTIMAX 360G2 Accessories
InstaPATCH 360 Modules
SYSTIMAX 360G2 Modular Cartridges
SYSTIMAX 360G2 Modular Distribution Panels
Fiber Optic Patch Cords Configurator
Fiber Optic Connectors
 Standard Fiber Optic Connectors
 Fiber Optic QWIK II Connectors
Fiber Optic Adapters
 Standard Fiber Optic Adapters

Infrastructure Management Solutions

SYSTIMAX imVision®
iPatch® Infrastructure Management Copper Panels
iPatch® Infrastructure Management Fiber Optic Shelves
SYSTIMAX 360™ iPatch® Fiber Shelves & Modules

Faceplates

Modular Faceplates and Clips UK Applications
Modular Faceplates and Clips UK German/Benelux Applications
Modular Faceplates and Clips UK Applications

Cable Management

2 Post Racks
Shelves - 2 Post Racks
4 Post Racks
Horizontal Cable Management
EMEA Patch Cord Organizers
Vertical Cable Management



Enterprise

Category 6A Products

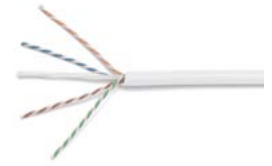

SYSTIMAX 360™ GigaSPEED X10D® U/UTP 3091B LSZH Cables

MATERIAL ID	PRODUCT NUMBER	PAIR COUNT	JACKET COLOR	LENGTH	PACKAGING
Z60106039	3091B BL 4/23 R1000	4	Blue	1000 ft (305 m)	Reel
Z60107326	3091B BL 4/23 W1000	4	Blue	1000 ft (305 m)	We Tote Box
Z60106062	3091B BL 4/23 R3000	4	Blue	3000 ft (914 m)	Reel
Z60105122	3091B WH 4/23 R1000	4	White	1000 ft (305 m)	Reel
Z60107318	3091B WH 4/23 W1000	4	White	1000 ft (305 m)	We Tote Box
Z60106054	3091B WH 4/23 R3000	4	White	3000 ft (914 m)	Reel
Z60106047	3091B SL 4/23 R1000	4	Slate	1000 ft (305 m)	Reel
Z60107334	3091B SL 4/23 W1000	4	Slate	1000 ft (305 m)	We Tote Box
Z60106070	3091B SL 4/23 R3000	4	Slate	3000 ft (914 m)	Reel



SYSTIMAX 360™ GigaSPEED X10D® 1100GS6 Panels

MATERIAL ID	PRODUCT NUMBER	DESCRIPTION	iPATCH READY	iPATCH
760152587	360-IPR-1100-E-GS6-1U-24	360 1100GS6 24-Port Evolve Patch Panel	X	
760152595	360-IPR-1100-E-GS6-2U-48	360 1100GS6 48-Port Evolve Patch Panel	X	
760151324	360-IPR-1100A-E-GS6-1U-24	360 1100GS6 24-Port Evolve Angled Patch Panel	X	
760151779	360-IPR-1100A-E-GS6-2U-48	360 1100GS6 48-Port Evolve Angled Patch Panel	X	



MATERIAL ID	PRODUCT NUMBER	DESCRIPTION
760151183	360-IPR-1100-GS6-DM6	360 1100GS6 Evolve Distribution Module 6-Port
760155739	360-E-KIT1U	360 1U Evolve Panel Kit for both GS6 and GS3
760155747	360-E-KIT2U	360 2U Evolve Panel Kit for both GS6 and GS3
760152785	360-A-E-KIT1U	360 Angled 1U Evolve Panel Kit for both GS6 and GS3
760152793	360-A-E-KIT2U	360 Angled 2U Evolve Panel Kit for both GS6 and GS3
760183244	360 and UNP Label Sheet US LTR	Label Sheet for 360 and Universal Panels, US letter
760186502	360 and UNP Label Sheet A4	Label Sheet for 360 and Universal Panels, A4

*Additional 1100GS6 products can be located in eCatalog on www.commscope.com or in the SYSTIMAX 360 Product Guide.

*Additional iPatch® Ready Modules, Panels and Shelves can be found in the Fiber Connectivity and iPatch Infrastructure Management Sections.

SYSTIMAX 360™ GigaSPEED X10D® PATCHMAX GS6 Panels



MATERIAL ID	PRODUCT NUMBER	DESCRIPTION	iPATCH READY	iPATCH
760102251	360-PM-GS6-2U-24	360 PATCHMAX GS6 24-Port Patch Panel	X	
760128207	360-PM-GS6-2U-48	360 PATCHMAX GS6 48-Port Patch Panel	X	

MATERIAL ID	PRODUCT NUMBER	DESCRIPTION
760102277	360-PM-GS6-DM6	360 PATCHMAX GS6 6-Port Distribution Module Kit
760128215	360-PM-GS6-DM12	360 PATCHMAX GS6 12-Port Distribution Module Kit
760108993	360-PM-KIT-2U-24	360 PATCHMAX 2U Panel Kit, 24-Port
760117408	360-PM-KIT-2U-48	360 PATCHMAX 2U Panel Kit, 48-Port
760183244	360 and UNP Label Sheet US LTR	Label Sheet for 360 and Universal Panels, US letter
760186502	360 and UNP Label Sheet A4	Label Sheet for 360 and Universal Panels, A4

*Additional iPatch® Ready Modules, Panels and Shelves can be found in the Fiber Connectivity and iPatch Infrastructure Management Sections.



SYSTIMAX 360™ GigaSPEED X10D® MGS600 Series Information Outlet

MATERIAL ID	PRODUCT NUMBER	COLOR	QUANTITY/PKG.
760092361	MGS600-003	Black	1
760092379	MGS600-112	Orange	1
760092387	MGS600-123	Yellow	1
760092403	MGS600-226	Green	1
760092411	MGS600-246	Ivory	1
760092429	MGS600-262	White	1
760092437	MGS600-270	Gray	1
760092445	MGS600-317	Red	1
760092452	MGS600-318	Blue	1
760092460	MGS600-361	Violet	1
760092478	MGS600-148	Almond	1

*Also available in bulk packs of 100



SYSTIMAX 360™ GigaSPEED X10D® 360GS10E Modular Patch Cords

MATERIAL ID	PRODUCT NUMBER	DESCRIPTION	MODULAR JACK COLOR	CORD COLOR OPTIONS	UOM	CABLE/CORDAGE LENGTH OPTIONS
CPCSSZ2	360GS10E-L	360GS10E Solid LSZH Cordage	0	1,2,3,4,6,7,8,9,B,C,Z	F	3-100ft
CPCS4Z2	360GS10E117-L	360GS10E Single-ended Solid LSZH Cordage	0	1,2,3,4,6,7,8,9,B,C,Z	F	3-100ft

Ordering Material ID Example: **C P C S S Z 2 - 0 2 F 0 0 7**

Information regarding T568A standard (A-wired) patch cord is available from your local sales representative.
 *SecureMAX Patch Cords and Accessories are not available for sale in Europe, Russia, Australia and Japan.
 Please contact your local sales representative to check availability in your country.

Cord Color Options: 1=BK (Black), 2=LB (Light Blue), 3=DG (Dark Gray), 4=GN (Spring Green), 6=OR (Orange), 7=RD (Red), 8=WH (White), 9=YL (Yellow),
 B=LL (Lilac), C=SL (Slate), Z=BL (Blue)



Enterprise

SYSTIMAX 360™ GigaSPEED XL® (Category 6)

Copper Solutions



SYSTIMAX 360™ GigaSPEED XL® U/UTP 3071E LSZH Cables

MATERIAL ID	PRODUCT NUMBER	PAIR COUNT	JACKET COLOR	LENGTH	PACKAGING
700216484	3071 004EBL 4/23 R1000	4	Blue	1 000 ft (305 m)	Reel
700216492	3071 004EBL 4/23 W1000	4	Blue	1 000 ft (305 m)	We Tote Box
760070466	3071 004E3BL 4/23 R3000	4	Blue	3 000 ft (914 m)	Reel
760081265	3071 004EBL 4/23 R3000	4	Blue	3 000 ft (914 m)	Reel
760011544	3071 004E3VWH 4/23 W1000	4	White	1 000 ft (305 m)	We Tote Box
700216443	3071 004EWH 4/23 R1000	4	White	1 000 ft (305 m)	Reel
700216450	3071 004EWH 4/23 W1000	4	White	1 000 ft (305 m)	We Tote Box
760006346	3071 004E3VWH 4/23 R1000	4	White	1 000 ft (305 m)	Reel
760081281	3071 004EWH 4/23 R3000	4	White	3 000 ft (914 m)	Reel
700216419	3071 004ESL 4/23 R1000	4	Slate	1 000 ft (305 m)	Reel
760095554	3071 004ESL 4/23 W1000	4	Slate	1 000 ft (305 m)	We Tote Box

* Other colors available, contact your local sales representative



SYSTIMAX 360™ GigaSPEED XL® 1100GS3 Panels

MATERIAL ID	PRODUCT NUMBER	DESCRIPTION	iPATCH READY
760152561	360-IPR-1100E-GS3-1U-24	360 1100GS3 24-Port Evolve Patch Panel	X
760152579	360-IPR-1100E-GS3-2U-48	360 1100GS3 48-Port Evolve Patch Panel	X
760151308	360-IPR-1100A-E-GS3-1U-24	360 1100GS3 24-Port Evolve Angled Patch Panel	X
760151753	360-IPR-1100A-E-GS3-2U-48	360 1100GS3 48-Port Evolve Angled Patch Panel	X

MATERIAL ID	PRODUCT NUMBER	DESCRIPTION
760151167	360-IPR-1100GS3-DM6	360 1100GS3 Evolve Distribution Module 6-Port
760155739	360-E-KIT-1U	360 1U Evolve Panel Kit for both GS6 and GS3
760155747	360-E-KIT-2U	360 2U Evolve Panel Kit for both GS6 and GS3
760152785	360-A-E-KIT-1U	360 Angled 1U Evolve Panel Kit for both GS6 and GS3
760152793	360-A-E-KIT-2U	360 Angled 2U Evolve Panel Kit for both GS6 and GS3
760183244	360 and UNP Label Sheet US LTR	Label Sheet for 360 and Universal Panels, US letter
760186502	360 and UNP Label Sheet A4	Label Sheet for 360 and Universal Panels, A4

*Additional 1100GS3 products can be located in eCatalog on www.commscope.com.

*Additional iPatch® Ready Modules, Panels and Shelves can be found in the Fiber Connectivity and iPatch Infrastructure Management Sections.



SYSTIMAX 360™ GigaSPEED XL® PATCHMAX® GS3 Panels

MATERIAL ID	PRODUCT NUMBER	DESCRIPTION	iPATCH READY
760102244	360-PM-GS3-2U-24	360 PATCHMAX GS3 24-Port Patch Panel	X
760117366	360-PM-GS3-2U-48	360 PATCHMAX GS3 48-Port Patch Panel	X

MATERIAL ID	PRODUCT NUMBER	DESCRIPTION
760108993	360-PM-KIT-2U-24	360 PATCHMAX 2U Panel Kit, 24-Port
760117408	360-PM-KIT-2U-48	360 PATCHMAX 2U Panel Kit, 48-Port
760117382	360-PM-GS3-DM-12	360 PATCHMAX GS3 12-Port Distribution Module Kit
760183244	360 and UNP Label Sheet US LTR	Label Sheet for 360 and Universal Panels, US letter
760186502	360 and UNP Label Sheet A4	Label Sheet for 360 and Universal Panels, A4

*Additional PATCHMAX GS3 products can be located in eCatalog on www.commscope.com or in the SYSTIMAX 360 Product Guide.



SYSTIMAX 360™ GigaSPEED XL® MGS400 Information Outlet

MATERIAL ID	PRODUCT NUMBER	COLOR	QUANTITY/PKG.
Z00206667	MGS400-003	Black	1
Z00206683	MGS400-112	Orange	1
Z00206691	MGS400-123	Yellow	1
Z00206709	MGS400-226	Green	1
Z00206725	MGS400-262	White	1
Z00206741	MGS400-317	Red	1
Z00206758	MGS400-318	Blue	1
Z00206675	MGS400-361	Violet	1
Z60070326	MGS400-215	Misty Cream	1
Z00206717	MGS400-246	Ivory	1
Z00206733	MGS400-270	Gray	1

*Also available in bulk packs of 100



SYSTIMAX 360™ GigaSPEED XL® GS8E Modular Patch Cords (U/UTP)

MATERIAL ID	PRODUCT NUMBER	DESCRIPTION	MODULAR JACK COLOR	CORD COLOR OPTIONS	UOM	CABLE/CORDAGE LENGTH OPTIONS
CPC3372	GS8E-SP	GS8E Solid Plenum Cable Modular Cord	0	1,4,6,7,8,9,B,C,Z	F	1-100ft
CPC3392	GS8E-L	GS8E Stranded LSZH Cordage	0	2,4,6,7,8,9,B,Z	F	1-100ft
CPC3472	GS8E117-SP	GS8E Single-ended Solid Plenum Modular Cord	0	1,4,6,7,8,9,B,C,Z	F	1-100ft
CPC3492	GS8E117-L	GS8E Single-ended Stranded LSZH Cordage	0	1,2,3,4,6,7,8,9,B,Z	F	1-100ft
CPC3222	GS8E-MGS400-SL	GS8E-MGS400 on 3071 Solid LSZH Cable	1,2,3,4,5,6,7,8,9	1,2,3,4,6,7,8,9,B,Z	F	1-300ft
CPC3422	GS8E117-SL	GS8E Single-ended Solid LSZH Cable	0	1,2,3,4,6,7,8,9,B,Z	F	1-100ft
CPC2222	MGS400-MGS400-SL	MGS400-MGS400 on 3071 Solid LSZH Cable	1,2,3,4,5,6,7,8,9	8,B	F	1-300ft

Ordering Material ID Example: **CPC3372-01F001**

Cord Color Options: 1=BK (Black), 2=LB (Light Blue), 3=DG (Dark Gray), 4=GN (Spring Green), 6=OR (Orange), 7=RD (Red), 8=WH (White), 9=YL (Yellow), B=LL (Lilac), C=SL (Slate), Z=BL (Blue)



Enterprise



PowerSUM U/UTP Low Smoke Zero Halogen Cables

MATERIAL ID	PRODUCT NUMBER	PAIR COUNT	JACKET COLOR	LENGHT	PACKAGING
760081232	3061 004ABL 4/24 R3000	4	Blue	3000 ft (914 m)	Reel
107573537	3061 004AVH 4/24 R1000	4	White	1000 ft (305 m)	Reel
107573545	3061 004AVH 4/24 W1000	4	White	1000 ft (305 m)	We Tote Box
760081257	3061 004AVH 4/24 R3000	4	White	3000 ft (914 m)	Reel

PowerSUM Modular Patch Panels



MATERIAL ID	PRODUCT NUMBER	DESCRIPTION
760182907	1100-U-PS 24	1100 Universal PS Panel 24 Port
760182915	1100-U-PS 48	1100 Universal PS Panel 48 Port
760182923	1100A-U-PS-24	1100 Angled Universal PS Panel 24 Port
760182931	1100A-U-PS-48	1100 Angled Universal PS Panel 48 Port
760183244	360 and UNP Label Sheet US LTR	Label Sheet for 360 and Universal Panels, US letter
760186502	360 and UNP Label Sheet A4	Label Sheet for 360 and Universal Panels, A4

PATCHMAX® PowerSUM 1100PS Patch Panels



MATERIAL ID	PRODUCT NUMBER	DESCRIPTION
108320029	PM2150PSE-24	PATCHMAX PowerSUM Patch Panel, 24-Port
108320045	PM2150PSE-48	PATCHMAX PowerSUM Patch Panel, 48-Port

PowerSUM (Category 5e)



PowerSUM Information Outlets

MATERIAL ID	PRODUCT NUMBER	WIRING	COLOR	QUANTITY
108232695	MPS100E-003	T568A, T568B	Black	1
108232703	MPS100E-112	T568A, T568B	Orange	1
108232711	MPS100E-123	T568A, T568B	Yellow	1
108232729	MPS100E-226	T568A, T568B	Green	1
108232737	MPS100E-246	T568A, T568B	Electrical Ivory	1
108232745	MPS100E-262	T568A, T568B	Electrical White	1
108232752	MPS100E-270	T568A, T568B	Electrical Gray	1
108232760	MPS100E-317	T568A, T568B	Red	1
108232778	MPS100E-318	T568A, T568B	Blue	1
108337726	MPS100E-361	T568A, T568B	Violet	1
108480484	MPS100E-215	T568A, T568B	Misty Cream	1

PowerSUM D8PS Modular Patch Cord



MATERIAL ID	PRODUCT NUMBER	DESCRIPTION	JACK COLOR	CORD COLOR OPTIONS	UOM	CABLE/CORDAGE LENGTH OPTIONS
CPC6442	D8PS	D8PS Single End Stranded Cordage Modular Patch Cord, T568B	0	1,2,3,4,6,7,8,9,B,Z	F	1-100 ft
CPC6642	D8PS	D8PS Stranded Cordage Modular Patch Cord	0	1,2,3,4,6,7,8,9,B,Z	F	1-100 ft
CPC6643	D8PS-X3	D8PS 10/100BASE-T 2X3 & 1X4 Crossover	0	1,2,3,4,6,7,8,9,B,Z	F	1-100 ft

Ordering Material ID Example: **C P C 6 6 4 2 - 0 2 F 0 0 7**

Information regarding T568A standard (A-wired) patch cord is available from your local sales representative.

Cord Color Options: 1=BK (Black), 2=LB (Light Blue), 3=DG (Dark Gray), 4=GN (Spring Green), 6=OR (Orange), 7=RD (Red), 8=WH (White), 9=YL (Yellow), B=LL (Lilac), C=SL (Slate), Z=BL (Blue)



Enterprise

VisiPatch 360®

Copper Solutions



VisiPatch 360® Patch Panel Kits

MATERIAL ID	PRODUCT NUMBER	DESCRIPTION	CONTENTS
Z60049445	VP360-4U-32P	VisiPatch 360 4U (32-Ports) Kit	VisiPatch 360 Back Panel 4U, 1 VisiPatch 360 Wiring Block, 4 VisiPatch 360 Wiring Block Cover, 4 VisiPatch 360 Connecting Block, 32 VisiPatch Label Holder, 4 White Label, 12
Z60049452	VP360-12U-96P	VisiPatch 360 12U (96-Ports) Kit	VisiPatch 360 Back Panel 12U, 1 VisiPatch 360 Wiring Block, 12 VisiPatch 360 Wiring Block Cover, 12 VisiPatch 360 Connecting Block, 96 VisiPatch Label Holder, 12 White Label, 12

VisiPatch 360® Cable Manager Kits - Vertical



MATERIAL ID	PRODUCT NUMBER	DESCRIPTION	CONTENTS
Z60060285	VP360-12U-10VTCM	VisiPatch 360 12U Vertical Trough Cable Management Kit with Door, 10" wide	VisiPatch 360 12U VTCM Door, 1 4U Spacer Module, 3 4U Spacer Module Extender, 3 Macro Cable/Cord Retainer, 3

VisiPatch 360® Cable Manager Kits - Horizontal



MATERIAL ID	PRODUCT NUMBER	DESCRIPTION	CONTENTS
Z60060301	VP360-HCM-Kit-27	VisiPatch 360 Horizontal Cable Management Kit, 27" wide	4U Back Panel Base, 2 Horizontal CM Trough, 4 Horizontal Trough Cover, 2
Z60060343	VP360-HCM-Kit-19	VisiPatch 360 Horizontal Cable Management Kit, 19" wide	
Z60060863	VP360-HCM-Kit-29	VisiPatch 360 Horizontal Cable Management Kit, 29" wide	
Z60060871	VP360-HCM-Kit-37	VisiPatch 360 Horizontal Cable Management Kit, 37" wide	

VisiPatch 360®

Copper Solutions



VisiPatch 360® GigaSPEED X10D Patch Cords

MATERIAL ID	PRODUCT NUMBER	DESCRIPTION	JACK COLOR	CORD COLOR OPTIONS	UOM	CABLE/CORDAGE LENGTH OPTIONS
CPCFFZ2	VP360T-VP360T-P8X10D-L	VisiPatch 360 - VisiPatch 360 4 pair Solid LSZH Patch Cord T	0	1,2,3,4,6,7,8,9,B,C,Z	F	7-100 ft
CPCFSZ2	VP360T-360GS10E-L	VisiPatch 360 - 360GS10E 4 pair Solid LSZH Patch Cord T	0	1,2,3,4,6,7,8,9,B,C,Z	F	7-100 ft

Ordering Material ID Example: **CPCFFZ2 - 0 3 F 0 0 7**

VisiPatch 360® GigaSPEED XL Patch Cords

MATERIAL ID	PRODUCT NUMBER	DESCRIPTION	JACK COLOR	CORD COLOR OPTIONS	UOM	CABLE/CORDAGE LENGTH OPTIONS
CPCFF92	VP360-VP360-P8XL-L	VP360-VP360-P8XL Patch Cord	0	1,2,3,4,6,7,8,9,B,Z	F	1-100ft
CPCF392	VP360-GS8E-L	VP360-GS8E Patch Cord	0	1,2,3,4,6,7,8,9,B,Z	F	1-100ft

Ordering Material ID Example: **CPCFF92 - 0 3 F 0 0 7**

VisiPatch 360® 1 Pair Patch Cord

MATERIAL ID	PRODUCT NUMBER	DESCRIPTION	JACK COLOR	CORD COLOR OPTIONS	UOM	CABLE/CORDAGE LENGTH OPTIONS
CPCFF62	VP360-VP360-P2PS	VisiPatch360-VisiPatch360 1-pair Cord	0	3	F	1-100 ft

Ordering Material ID Example: **CPCFF62 - 0 3 F 0 0 7**



VisiPatch® to VisiPatch Hybrid Patch Cord Configurator

MATERIAL ID BASE CODE	PRODUCT NUMBER	DESCRIPTION	TYPE	INFORMATION OUTLET COLOR	JACKET COLOR										UOM	CABLE/CORDAGE LENGTH OPTIONS
					BK	LB	DG	GN	OR	RD	WH	YL	LL	BL		
CPCF512	VP360-VP-P8GS	VisiPatch® 360 to VisiPatch 4 Pair Patch Cord	Patch Cord	0	1	2	3	4	6	7	8	9	B	Z	F	1-100 ft

Ordering Material ID Example: **CPCF512 - 0 6 F 0 2 5**

Cord Color Options: 1=BK (Black), 2=LB (Light Blue), 3=DG (Dark Gray), 4=GN (Spring Green), 6=OR (Orange), 7=RD (Red), 8=WH (White), 9=YL (Yellow), B=LL (Lilac), C=SL (Slate), Z=BL (Blue)



Enterprise

InstaPATCH® Cu Configurator



C A A A C - 1 1 H A 8 8 F 050

<p>Cable Type</p> <ul style="list-style-type: none"> A Cat 6A X10D - U/UTP (Plenum) B Cat 6A X10D - U/UTP (Riser) C Cat 6A X10D - U/UTP (LSZH) D Cat 6A X10D - F/UTP (Plenum) E Cat 6A X10D - F/UTP (Riser) F Cat 6A X10D - F/UTP (LSZH) G Cat 6 XL - U/UTP (Plenum) H Cat 6 XL - U/UTP (Riser) J Cat 6 XL - U/UTP (LSZH) Q Cat 6A X10D - S/FTP (LSZH) 	<p>Link</p> <ul style="list-style-type: none"> B 6 C 8 D 12 E 16 F 18 G 24 	<p>Orientation A</p> <ul style="list-style-type: none"> 1 Trident Series Flat 2 Right Paired Flat 3 Right Series Flat 4 Left Paired Flat 5 Left Series Flat 6 Trident Paired Flat A Trident Series Angled B Right Paired Angled C Right Series Angled D Left Paired Angled E Left Series Angled F Trident Paired Angled 	<p>Bundling</p> <ul style="list-style-type: none"> H Hook-n-loop S Slewing 	<p>Outlet Color</p> <ul style="list-style-type: none"> 0 Not Applicable 1 Black (BK) 2 Blue (BL) 8 White (WH) 	<p>UOM</p> <ul style="list-style-type: none"> F Feet 	<p>Length</p> <ul style="list-style-type: none"> XXX
<p>Connector A</p> <ul style="list-style-type: none"> A Outlet* – Single Row Standard Density B Outlet* – Dual Row Standard Density G RJ45 Plug N 1100 Module R 360 1100 Evolve Module S Onelink 2x6 T Onelink 2x4 	<p>Connector B</p> <ul style="list-style-type: none"> A Outlet* – Single Row Standard Density B Outlet* – Dual Row Standard Density G RJ45 Plug N 1100 Module R 360 1100 Evolve Module S Onelink 2x6 T Onelink 2x4 X Unterminated 	<p>Orientation B</p> <ul style="list-style-type: none"> 1 Trident Series Flat 2 Right Paired Flat 3 Right Series Flat 4 Left Paired Flat 5 Left Series Flat 6 Trident Paired Flat A Trident Series Angled B Right Paired Angled C Right Series Angled D Left Paired Angled E Left Series Angled F Trident Paired Angled X Not Applicable 	<p>Labeling</p> <ul style="list-style-type: none"> A Generic Label 	<p>Jacket Color</p> <ul style="list-style-type: none"> 3 Dark Gray (DG) 8 White (WH) Z Blue (BL) 		

Configurations are not limited to the above.

Please contact your local sales representative for more information.

* Note: Connector A and Connector B Applications:

- A** Outlet - Single Row Standard Density (supports M2400, 360M FTP panel)
- B** Outlet - Dual Row Standard Density (supports M2000, M2100, M3200, 360M UTP panels)

Pre-Terminated Cable Assembly Configurations

BASE PART	MATERIAL RATING	PERFORMANCE	CONNECTOR A	CONNECTOR B	CABLE	PORT COUNT	CABLE COLOR	UOM	LENGTH
IQ	P - Plenum	1 - Category 6A U/UTP	QP - QUATTRO (MC) Plug	QP - QUATTRO (MC) Plug	V - Bundled	4 - 4 Port	A - Blue	F - Foot	XXX
	R - Riser	3 - Category 6 U/UTP		RJ - RJ45 Plug			E - Slate	M - Meter	(005-295 ft) (001-090 m)
	Z - LSZH						F - White		

Example ordering code for a CMR, 6A, U/UTP, QUATTRO to QUATTRO, Bundled, Blue, trunk = IQP1QPQPV4-AFO50

Please refer to InstaPATCH QUATTRO Design and Installation Guidelines for trunk/cord length limitations.

Panel and Cassette Module

MATERIAL ID	PRODUCT NUMBER	DESCRIPTION
Z60160507	IPQ-IPR-1U-24P	InstaPATCH QUATTRO 1U Panel, 24 port with 6 modules, intelligence ready, preloaded
Z60160523	IPQ-1U-48P	InstaPATCH QUATTRO 1U Panel, 48 port with 12 modules, preloaded
Z60160499	IPQ-IPR-1U-24P-Empty	InstaPATCH QUATTRO 1U Panel, 24 port, empty, intelligence ready, unloaded
Z60160515	IPQ-1U-48P-Empty	InstaPATCH QUATTRO 1U Panel, 48 port, empty, unloaded
Z60159632	IPQ-Module-4P-6A	InstaPATCH QUATTRO 4-Port Module
Z60161000	360-iP-INSTA-QTRO-24P	360 iPatch InstaPATCH QUATTRO 1U Panel, 24 port
Z60159905	360-iP-UP-KITIPQ-24P	360 iPatch 1U Panel Upgrade Kit InstaPATCH QUATTRO, 24 port, 10 pack

*Additional iPatch® Ready Modules, Panels and Shelves can be found in the Fiber Connectivity and iPatch Infrastructure Management Sections.

Surface Mount Boxes

MATERIAL ID	PRODUCT NUMBER	DESCRIPTION
Z60193367	IPQ-SMB-4P	InstaPATCH QUATTRO Surface Mount Box, 4-port (without module)
Z60193375	IPQ-SMB-8P	InstaPATCH QUATTRO Surface Mount Box, 8-port (without module)

Replacement Accessories

MATERIAL ID	PRODUCT NUMBER	DESCRIPTION
Z60160549	IPQ-Mod-Label	InstaPATCH QUATTRO Module Label Sheet, 10 labels
Z60161059	IPQ-1U-48P-End Caps -10PK	InstaPATCH QUATTRO Panel, 48 port, end caps, 10 pack
Z60101931	IPQ-1U-24P-Bezel	InstaPATCH QUATTRO Panel, 24 port, bezel
Z60171041	IPQ-Blank-4P	InstaPATCH QUATTRO Blank Panels, 12 pack



Enterprise

Modular Panels

Modular Panels



SYSTIMAX 360™ Modular Panels

MATERIAL ID	PRODUCT NUMBER	DESCRIPTION
760187187	360E-MOD-1U-24	360 Evolve 24 Port Panel
760187179	360 Evolve M-Series Adapter - 4 Pk	360 Evolve M-Series Adapter - 4 Pk
760187278	360 E Mod Label Sheet US LTR	360 Modular Panel Label Sheet US LTR
760187286	360 E Mod Label Sheet A4	360 Modular Panel Label Sheet A4
760187195	360E-MOD-2U-48	360 Evolve 48 Port Panel
760187203	360E-ANG-MOD-1U-24	360 Evolve Angled 24 Port Panel
760187211	360E-ANG-MOD-2U-48	360 Evolve Angled 48 Port Panel



M4800/M4800A 1U High Density Modular Panels

MATERIAL ID	PRODUCT NUMBER	DESCRIPTION
760105429	M4800-1U-GS	M4800 1U 48-Port Panel - GS
760104307	M4800-1U-PS	M4800 1U 48-Port Panel - PS
760109744	M4800A-1U-GS	M4800A 1U Angled 48-Port Panel - GS
760109736	M4800A-1U-PS	M4800A 1U Angled 48-Port Panel - PS
760104737	360-RCM-RM	Rear Cable Management System (Rack Mountable)

M2000 Modular Patch Panels



MATERIAL ID	PRODUCT NUMBER	DESCRIPTION
760049932	M2000-24 1U	M2000 24-Port 1U Panel
760049940	M2000-48 2U	M2000 48-Port 2U Panel
760049957	M2000A-24 1U (Angled)	M2000A 24-Port 1U Panel (angled)
760049965	M2000A-48 2U (Angled)	M2000A 48-Port 2U Panel (angled)

M2100 Modular Patch Panels



MATERIAL ID	PRODUCT NUMBER	DESCRIPTION
760101220	M2100-24	M2100-1U Modular Patch Panel
760077842	M2100-48	M2100-2U Modular Patch Panel



Enterprise

Coax Cables



Video Cables

MATERIAL ID	PRODUCT NUMBER	DESCRIPTION	JACKET COLOR	PACKAGING
8265103/10	5572	75 Ω, Non-Plenum, Series 59, 20 AWG Solid CCS	Black	Reel
8208804/10	5540	75 Ω, Non-Plenum, Series 59, 20 AWG Solid CCS	Black	Reel
4265603/10	5730H	75 Ω, LSZH, Series 6, 18 AWG Solid CCS	White	Reel
8223504/10	5781	75 Ω, Non-Plenum, Series 6, 18 AWG Solid CCS	Black	Reel
8203603/10	5916	75 Ω, Non-Plenum, Series 11, 14 AWG Solid CCS	Black	Reel
4265303/10	5565H	75 Ω, LSZH, Series 59, 20 AWG Solid CCS	White	Reel
4265503/10	5715H	75 Ω, LSZH, Series 6, 18 AWG Solid CCS	White	Reel
4265603/10	5730H	75 Ω, LSZH, Series 6, 18 AWG Solid CCS	White	Reel
4266203/10	5925H	75 Ω, LSZH, Series 11, 14 AWG Solid BC	White	Reel

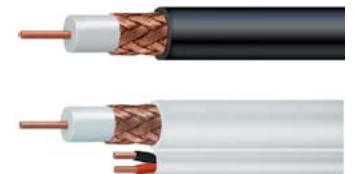

Security Cables

MATERIAL ID	PRODUCT NUMBER	DESCRIPTION	JACKET COLOR	PACKAGING
4254203/10	5554	75 Ω, Non-Plenum, Series 59, 20 AWG Solid BC	Black	Reel
8288103/10	5654	75 Ω, Non-Plenum, Series 6, 18 AWG Solid BC	Black	Reel
4265703/10	5700H	75 Ω, LSZH, Series 6, 18 AWG Solid CCS	White	Reel
4265913/10	5553H	75 Ω, LSZH, Series 59, 20 AWG Solid BC	White	Reel



Enterprise

Fiber Solutions

Basic Configurator for Fiber Optic Cables

P - **012** - **DS** - **5L** - **F** **SU** **AQ**
 Position 1 Position 2 Position 3 Position 4 Position 5 Position 6 Position 7

Sample Part Number

Position 1: Cable Style

P - 012 - DS - 5L - FSUAQ

D All Dry Outside Plant	Z Zero Halogen Indoor/Outdoor	O Outside Plant (Arid Core®)
M Messenger	P Plenum	S Outside Plant (All Dielectric, Self-Supporting)
N Zero Halogen (Indoor Only)	R Riser	

Position 2: Fiber Count

P - 012 - DS - 5L - FSUAQ

Total Fiber Count (XXX variable in catalog number)

Position 3: Cable Construction

P - 012 - DS - 5L - FSUAQ

Outside Plant Cable Constructions

LA Stranded Loose Tube Armored	DA Drop Armored	MN Mini-drop All Dielectric
LN Stranded Loose Tube Non Armored All Dielectric	DF Flat Drop All-Dielectric	
LD Stranded Loose Tube All Dielectric/Dual Jacket	DN Drop All Dielectric	
L2 Stranded Loose Tube Dual Jacket/Single Armor	CN Central Tube Non Armored All Dielectric	
L3 Stranded Loose Tube Triple Jacket/Dual Armor	CA Central Tube Armored	

Indoor & Indoor/Outdoor Cable Constructions

Tight Buffer

DS Distribution **OD** I/O Plenum Distribution

Loose Tube

LN Stranded Loose Tube Non Armored All Dielectric **CN** Central Tube All Dielectric

Zipcord

ZC Zipcord **LH** Stranded Loose Tube Heavy Duty Non Armored

FiberGuard® For tight buffered and loose tube I/O cables only, use first character of the construction code above plus one of the following:

Z Aluminum Armor w/Jacket
 *LH cables cannot be Interlocked Armored

Position 4: Fiber Type

P - 012 - DS - 5L - FSUAQ

8W TeraSPEED single-mode	5M 50µm, LazrSPEED 150, multimode (OM2+)	5K 50µm, LazrSPEED 550, multimode (OM4)
6F OptiSPEED 62.5/125µm FDDI Grade, multimode (OM1)	5L 50µm, LazrSPEED 300, multimode (OM3)	

CM Composite (single-mode & multimode) **HY** Hybrid (Fiber, Copper, Coax)
 *XY variable in catalog number

Position 5: Jacket Print

P - 012 - DS - 5L - FSUAQ

F Printed in Feet (Standard)	M Printed in Meters	X Special Print
-------------------------------------	----------------------------	------------------------

Position 6: Miscellaneous Values

P - 012 - DS - 5L - FSUAQ

For cordage, value indicates outside diameter; otherwise additional description

01-12 Fiber Count per Subunit **SU** Single Unit **MU** Multi Unit

Cordage

16 1.6mm Jacket OD **20** 2.0mm Jacket **25** 2.5mm Jacket OD **29** 2.9mm Jacket OD

Position 7: Color Field

P - 012 - DS - 5L - FSUAQ

For Outside Plant Cables, this field designates color of stripe/tracer. Outside Plant Cables are manufactured with a standard black jacket — No Stripe (NS). Stripes (tracers) are also available in the following colors (min. order required):

BL Blue	OR Orange	GR Green	BR Brown	SL Slate	WH White
RD Red	BK Black	YL Yellow	VI Violet	RS Rose	AQ Aqua

For Distribution Cables, this field indicates jacket color. Standard jacket colors:

BK Black for Indoor/Outdoor and Tight Buffer Outside Plant	YL Yellow for single-mode
OR Orange for 62.5 Multimode & Composite	AQ Aqua for LazrSPEED & LazrSPEED Composites
SL Slate for 62.5 Multimode & Composite	

*ZZ variable in catalog number. *I/O and OSP Cables are black jacket only

For Indoor Distribution Cables and Zipcords. Available Non Standard jacket colors: (min. order required)

BL Blue	OR Orange	GR Green	BR Brown	SL Slate	WH White
RD Red	BK Black	YL Yellow	VI Violet	RS Rose	AQ Aqua

Positions 8-11: When Position 4 is CM

P - 012 - DS - CM - FSUAQ

8W 006 5L 006

Position 8: First Fiber Type **Position 10:** Second Fiber Type Pos. 8 Pos. 9 Pos. 10 Pos. 11
Position 9: First Fiber Count **Position 11:** Second Fiber Count

When single-mode and multimode fibers are used in a composite, then single-mode is positioned first

Positions 8-11: When Position 4 is HY

O - 012 - DN - HY - F12NS

8W 006 F6SSBW GSM 40T

Position 8: Fiber Type **Position 10:** Copper Type **Position 12:** Tube Size Pos. 8 Pos. 9 Pos. 10 Pos. 11 Pos. 12
Position 9: Fiber Count **Position 11:** Messenger Description

When no messenger is present, Tube Size moves to Position 11 and there is no Position 12. When Position 3 is LH, LN or LA, Position 8 is 25D, 20G or 20T
 *Other options are available that are not currently listed in the above chart.

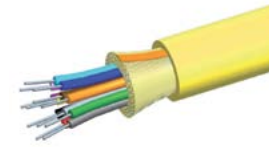

Single Unit

Material ID	Product Number	Fiber Count	Outer Diameter inch/mm	Min. Bend Radius		Max. Tensile Load		Weight kg/km
				Loaded inch/cm	Unloaded inch/cm	Short Term lbs./Newton	Long Term lbs./Newton	
Z60012153	N-006-DS-5K-FSUAQ	6	.20/5.1	3.8/9.5	1.9/4.8	300/1335	90/400	24
Z60012161	N-012-DS-5K-FSUAQ	12	.24/6.0	4.7/12.1	2.4/6.0	300/1335	90/400	36
Z60019117	N-024-DS-5K-FSUAQ	24	.33/8.4	6.6/16.7	3.3/8.4	300/1335	90/400	66
Z00009780	N-006-DS-5L-FSUAQ	6	.20/5.1	3.8/9.5	1.9/4.8	300/1335	90/400	24
Z00009749	N-012-DS-5L-FSUAQ	12	.24/6.0	4.7/12.1	2.4/6.0	300/1335	90/400	36
Z60019109	N-024-DS-5L-FSUAQ	24	.33/8.4	6.6/16.7	3.3/8.4	300/1335	90/400	66
Z00009806	N-006-DS-5M-FSUAQ	6	.20/5.1	3.8/9.5	1.9/4.8	300/1335	90/400	24
Z00009764	N-012-DS-5M-FSUAQ	12	.24/6.0	4.7/12.1	2.4/6.0	300/1335	90/400	36
Z60019091	N-024-DS-5M-FSUAQ	24	.33/8.4	6.6/16.7	3.3/8.4	300/1335	90/400	66
Z60004242	N-006-DS-8W-FSUYL	6	.20/5.1	3.8/9.5	1.9/4.8	300/1335	90/400	24
Z60004267	N-012-DS-8W-FSUYL	12	.24/6.0	4.7/12.1	2.4/6.0	300/1335	90/400	36
Z60019091	N-024-DS-8W-FSUYL	24	.33/8.4	6.6/16.7	3.3/8.4	300/1335	90/400	66
760008469	N-006-DS-6F-FSUOR	6	.20/5.1	3.8/9.5	1.9/4.8	300/1335	90/400	24
760008444	N-012-DS-6F-FSUOR	12	.24/6.0	4.7/12.1	2.4/6.0	300/1335	90/400	36
760001903	N-024-DS-6F-FSUOR	24	.33/8.4	6.6/16.7	3.3/8.4	300/1335	90/400	66

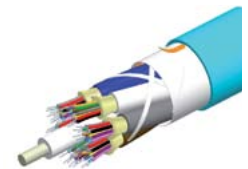

Multi Unit

Material ID	Product Number	Fiber Count	Outer Diameter inch/mm	Min. Bend Radius		Max. Tensile Load		Weight kg/km
				Loaded inch/cm	Unloaded inch/cm	Short Term lbs./Newton	Long Term lbs./Newton	
Z00211121	N-048-DS-5L-FMUAQ	48	.63/16.1	12.7/32.2	6.3/16.1	800/3560	240/1068	224
Z00211139	N-072-DS-5L-FMUAQ	72	.79/20.0	15.8/40.1	7.9/20.0	1000/4450	300/1335	360
Z00211089	N-048-DS-5M-FMUAQ	48	.63/16.1	12.7/32.2	6.3/16.1	800/3560	240/1068	224
Z00211097	N-072-DS-5M-FMUAQ	72	.79/20.0	15.8/40.1	7.9/20.0	1000/4450	300/1335	360
Z60004291	N-048-DS-8W-FMUYL	48	.63/16.1	12.7/32.2	6.3/16.1	800/3560	240/1068	224
Z60004309	N-072-DS-8W-FMUYL	72	.79/20.0	15.8/40.1	7.9/20.0	1000/4450	300/1335	360
Z00009103	N-048-DS-6F-FMUOR	48	.63/16.1	12.7/32.2	6.3/16.1	800/3560	240/1068	224
Z00009012	N-072-DS-6F-FMUOR	72	.79/20.0	15.8/40.1	7.9/20.0	1000/4450	300/1335	360

Distribution Cables

LSZH Indoor/Outdoor Distribution Cables with Tight Buffered Fibres

Material ID	Product Number	Fiber Count	Outer Diameter inch/mm	Min. Bend Radius		Max. Tensile Load		Weight kg/km
				Loaded inch/cm	Unloaded inch/cm	Short Term lbs./Newton	Long Term lbs./Newton	
Z60005165	Z-004-DS-6F-FSUBK	4	5.10 mm	4.0/10.1	2.0/5.1	300/1335	90/400	20
Z60054973	Z-006-DS-6F-FSUBK	6	5.50 mm	4.4/11.1	2.2/5.5	300/1336	90/400	26
Z00211279	Z-012-DS-6F-FSUBK	12	14.10 mm	5.7/14.4	2.8/7.2	300/1337	90/400	178
Z60070318	Z-024-DS-6F-FSUBK	24	8.70 mm	6.9/17.4	3.4/8.7	300/1338	90/400	67
Z00211022	Z-024-DS-5M-FMUBK	24	16.90 mm	13.3/33.9	6.7/16.9	600/ 2670	180/801	198
Z00211030	Z-036-DS-5M-FMUBK	36	17.80 mm	14.1/35.7	7.0/17.8	800/3560	240/1068	242
Z60046623	Z-004-DS-5M-FSUBK	4	5.10 mm	4.0/10.1	2.0/5.1	300/1335	90/400	20
Z60046631	Z-006-DS-5M-FSUBK	6	12.80 mm	4.4/11.1	2.2/5.5	300/1335	90/400	95
Z00211014	Z-012-DS-5M-FSUBK	12	14.10 mm	5.7/14.4	2.8/7.2	300/1335	90/400	178
Z60070284	Z-024-DS-5M-FSUBK	24	8.70 mm	6.9/17.4	3.4/8.7	300/1335	90/400	67
Z00210990	Z-024-DS-5L-FMUBK	24	16.90 mm	13.3/33.9	6.7/16.9	600/ 2670	180/801	198
Z00211006	Z-036-DS-5L-FMUBK	36	17.80 mm	14.1/35.7	7.0/17.8	800/3560	240/1068	242
Z60010371	Z-048-DS-5L-FMUBK	48	20.20 mm	15.9/40.4	8.0/20.2	800/3560	240/1068	307
Z60019612	Z-072-DS-5L-FMUBK	72	24.10 mm	19.0/48.2	9.5/24.1	1000/4450	300/1335	477
Z60143198	Z-002-DS-5L-FSUBK	2	3.80 mm	3.0/7.7	1.5/3.8	225/1001	68/300	11.6
Z60046649	Z-004-DS-5L-FSUBK	4	5.10 mm	4.0/10.1	2.0/5.1	300/1335	90/400	20
Z60039966	Z-006-DS-5L-FSUBK	6	5.50 mm	4.4/11.1	2.2/5.5	300/1335	90/400	26
Z60031674	Z-008-DS-5L-FSUBK	8	6.30 mm	5.0/12.6	2.5/6.3	300/1335	90/400	35
Z00210982	Z-012-DS-5L-FSUBK	12	7.20 mm	5.7/14.4	2.8/7.2	400/1780	120/534	49
Z60070292	Z-024-DS-5L-FSUBK	24	15.40 mm	6.9/17.4	3.4/8.7	300/1335	90/400	212
Z60039974	Z-006-DS-5K-FSUBK	6	5.50 mm	4.4/11.1	2.2/5.5	300/1335	90/400	26
Z60039982	Z-008-DS-5K-FSUBK	8	6.30 mm	5.0/12.6	2.5/6.3	300/1335	90/400	35
Z60006650	Z-012-DS-5K-FSUBK	12	7.20 mm	5.7/14.4	2.8/7.2	400/1780	120/534	49
Z60070300	Z-024-DS-5K-FSUBK	24	8.70 mm	6.9/17.4	3.4/8.7	300/1335	90/400	67
Z60004192	Z-024-DS-8W-FMUBK	24	25.50 mm	13.3/33.9	6.7/16.9	300/1335	90/400	430
Z60004200	Z-036-DS-8W-FMUBK	36	17.80 mm	14.1/35.7	7.0/17.8	800/3560	240/1068	242
Z60090309	Z-048-DS-8W-FMUBK	48	20.20 mm	15.9/40.4	8.0/20.2	800/3560	240/1068	307
Z60067595	Z-072-DS-8W-FMUBK	72	31.90 mm	19.0/48.2	9.5/24.1	300/1335	90/400	744
Z60068718	Z-004-DS-8W-FSUBK	4	5.10 mm	4.0/10.1	2.0/5.1	300/1335	90/400	20
Z60009753	Z-006-DS-8W-FSUBK	6	5.50 mm	4.4/11.1	2.2/5.5	300/1335	90/400	26
Z60073403	Z-008-DS-8W-FSUBK	8	6.30 mm	5.0/12.6	2.5/6.3	300/1335	90/400	35
Z60004184	Z-012-DS-8W-FSUBK	12	7.20 mm	5.7/14.4	2.8/7.2	400/1780	120/534	49
Z60070276	Z-024-DS-8W-FSUBK	24	8.70 mm	6.9/17.4	3.4/8.7	300/1335	90/400	67

Distribution Cables

LSZH Indoor/Outdoor Stranded Loose Tube Non-Armored All Dielectric Cables

Material ID	Product Number	Fiber Count	Outer Diameter inch/mm	Min. Bend Radius		Max. Tensile Load		Weight kg/km
				Loaded inch/cm	Unloaded inch/cm	Short Term lbs./Newton	Long Term lbs./Newton	
Z60100842	Z004IN-5LF04BK/20G	4	11.00 mm	6.5/16.5	4.3/11.0	607/2700	180/800	171
Z60091827	Z006IN-5LF06BK/20G	6	11.00 mm	6.5/16.5	4.3/11.0	607/2700	180/800	171
Z60091835	Z012IN-5LF12BK/20G	12	11.00 mm	6.5/16.5	4.3/11.0	607/2700	180/800	171
Z60091843	Z024IN-5LF12BK/20G	24	11.00 mm	6.5/16.5	4.3/11.0	607/2700	180/800	171
Z60100198	Z072IN-5LF12BK/20G	72	11.00 mm	6.5/16.5	4.3/11.0	607/2700	180/800	171
Z60100206	Z096IN-5LF12BK/20G	96	12.00 mm	7.1/18.0	4.7/12.0	607/2700	180/800	195
Z60098392	Z004IN-8WF04BK/20G	4	11.00 mm	6.5/16.5	4.3/11.0	607/2700	180/800	171
Z60091728	Z006IN-8WF06BK/20G	6	11.00 mm	6.5/16.5	4.3/11.0	607/2700	180/800	171
Z60091736	Z012IN-8WF12BK/20G	12	11.00 mm	6.5/16.5	4.3/11.0	607/2700	180/800	171
Z60091744	Z024IN-8WF12BK/20G	24	11.00 mm	6.5/16.5	4.3/11.0	607/2700	180/800	171
Z60091751	Z036IN-8WF12BK/20G	36	11.00 mm	6.5/16.5	4.3/11.0	607/2700	180/800	171
Z60091769	Z048IN-8WF12BK/20G	48	11.00 mm	6.5/16.5	4.3/11.0	607/2700	180/800	171
Z60091777	Z060IN-8WF12BK/20G	60	11.00 mm	6.5/16.5	4.3/11.0	607/2700	180/800	171
Z60091785	Z072IN-8WF12BK/20G	72	11.00 mm	6.5/16.5	4.3/11.0	607/2700	180/800	171
Z60091793	Z096IN-8WF12BK/20G	96	12.00 mm	7.1/18.0	4.7/12.0	607/2700	180/800	195
Z60091801	Z120IN-8WF12BK/20G	120	13.30 mm	7.8/19.9	5.2/13.3	607/2700	180/800	225
Z60091819	Z144IN-8WF12BK/20G	144	14.70 mm	8.7/22.0	5.8/14.7	607/2700	180/800	268



Mini LSZH Indoor/Outdoor High Tensile Strength Stranded Loose Tube Cables (Rodent Resistant)

Material ID	Product Number	Fiber Count	Outer Diameter inch/mm	Min. Bend Radius		Max. Tensile Load		Weight kg/km
				Loaded inch/cm	Unloaded inch/cm	Short Term lbs./Newton	Long Term lbs./Newton	
Z60146860	Z004IN-5LF04BK/20G/HTS	4	13.10 mm	7.7/19.6	5.2/13.1	1000/4448	300/1334	169
Z60146878	Z006IN-5LF06BK/20G/HTS	6	13.10 mm	7.7/19.6	5.2/13.1	1000/4448	300/1334	169
Z60146886	Z008IN-5LF08BK/20G/HTS	8	13.10 mm	7.7/19.6	5.2/13.1	1000/4448	300/1334	169
Z60103606	Z012IN-5LF12BK/20G/HTS	12	13.10 mm	7.7/19.6	5.2/13.1	607/2700	180/800	171
Z60146894	Z024IN-5LF12BK/20G/HTS	24	13.10 mm	7.7/19.6	5.2/13.1	1000/4448	300/1334	169
Z60146902	Z048IN-5LF12BK/20G/HTS	48	13.10 mm	7.7/19.6	5.2/13.1	1000/4448	300/1334	169
Z60136556	Z144IN-5LF12BK/20G/HTS	144	16.20mm	9.6/24.3	6.4/16.2	1000/4448	30/1334	265
Z60100727	Z012IN-8WF12BK/20G/HTS	12	13.10 mm	7.7/19.6	5.2/13.1	607/2700	180/800	171
Z60100735	Z024IN-8WF12BK/20G/HTS	24	13.10 mm	7.7/19.6	5.2/13.1	607/2700	180/800	171
Z60100743	Z048IN-8WF12BK/20G/HTS	48	13.10 mm	7.7/19.6	5.2/13.1	607/2700	180/800	171
Z60100750	Z096IN-8WF12BK/20G/HTS	96	13.90 mm	8.2/20.8	5.5/13.9	607/2700	180/800	195
Z60100768	Z144IN-8WF12BK/20G/HTS	144	16.20 mm	9.6/24.3	6.4/16.2	607/2700	180/800	268

Distribution Cables



Armored LSZH Indoor/Outdoor Mini Riser Stranded Loose Tube Arid-Core Cable, High Tensile Strength Single-Jacket Single-Armor

Material ID	Product Number	Fiber Count	Outer Diameter inch/mm	Min. Bend Radius		Max. Tensile Load		Weight kg/km
				Loaded inch/cm	Unloaded inch/cm	Short Term lbs./Newton	Long Term lbs./Newton	
Z60146688	Z-144IA-6FF12BK/20G	144	16.1 mm	7.3/18.5	4.8/12.3	607/2700	180/800	300
Z60130237	Z006IA-5LF06BK/20G	6	12.3 mm	7.3/18.5	4.8/12.3	607/2700	180/800	183
Z60146696	Z008IA-5LF08BK/20G	8	12.3 mm	7.3/18.5	4.8/12.3	607/2700	180/800	183
Z60122085	Z012IA-5LF12BK/20G	12	12.30 mm	7.3/18.5	4.8/12.3	607/2700	180/800	183
Z60130245	Z024IA-5LF12BK/20G	24	12.30 mm	7.3/18.5	4.8/12.3	607/2700	180/800	183
Z60142059	Z048IA-5LF12BK/20G	48	12.30 mm	7.3/18.5	4.8/12.3	607/2700	180/800	183
Z60130252	Z072IA-5LF12BK/20G	72	12.30 mm	7.3/18.5	4.8/12.3	607/2700	180/800	183
Z60146704	Z096IA-5LF12BK/20G	96	13.6 mm	20.4 cm	13.6 cm	607/2700	180/800	213
Z60146712	Z-144IA-5LF12BK/20G	144	16.1 mm	9.5/24.2	6.3/16.1	607/2700	180/800	300
Z60122010	Z004IA-8WF04BK/20G	4	12.3 mm	7.3/18.5	4.8/12.3	607/2700	180/800	183
Z60146787	Z006IA-8WF06BK/20G	6	12.3 mm	7.3/18.5	4.8/12.3	607/2700	180/800	183
Z60146795	Z008IA-8WF08BK/20G	8	12.3 mm	7.3/18.5	4.8/12.3	607/2700	180/800	183
Z60122028	Z012IA-8WF12BK/20G	12	12.3 mm	7.3/18.5	4.8/12.3	607/2700	180/800	183
Z60122036	Z024IA-8WF12BK/20G	24	12.3 mm	7.3/18.5	4.8/12.3	607/2700	180/800	183
Z60122051	Z048IA-8WF12BK/20G	48	12.3 mm	7.3/18.5	4.8/12.3	607/2700	180/800	183
Z60122069	Z072IA-8WF12BK/20G	72	12.3 mm	7.3/18.5	4.8/12.3	607/2700	180/800	183
Z60138362	Z096IA-8WF12BK/20G	96	13.6 mm	20.4 cm	13.6 cm	607/2700	180/800	213
Z60122077	Z-144IA-8WF12BK/20G	144	16.1 mm	9.5/24.2	6.3/16.1	607/2700	180/800	300

Indoor/Outdoor Cables



LSZH All-Dielectric Drop Indoor/Outdoor Cables

Material ID	Product Number	Fiber Count	Outer Diameter inch/mm	Min. Bend Radius		Max Tensile Load lbs./Newton	Crush Resistance	Weight
				Loaded inch/cm	Unloaded inch/cm			kg/km
Z60083360	Z006DN5LF06BK/20G	6	0.32/8.2	16.4/3.5	8.3/3.3	300/1334	90/400	72
Z60111369	Z012DN5LF12BK/20G	12	0.32/8.2	16.4/3.5	8.3/3.3	300/1334	90/400	72
Z60083386	Z024DN5LF12BK/20G	24	0.32/8.2	16.4/3.5	8.3/3.3	300/1334	90/400	72
Z60083303	Z006DN8WF06BK/20G	6	0.32/8.2	16.4/3.5	8.3/3.3	300/1334	90/400	72
Z60111337	Z012DN8WF12BK/20G	12	0.32/8.2	16.4/3.5	8.3/3.3	300/1334	90/400	72
Z60083329	Z024DN8WF12BK/20G	24	0.32/8.2	16.4/3.5	8.3/3.3	300/1334	90/400	72
Z60113027	Z006DN6FF06BK/20G	6	0.32/8.2	16.4/3.5	8.3/3.3	300/1334	90/400	72
Z60113035	Z012DN6FF12BK/20G	12	0.32/8.2	16.4/3.5	8.3/3.3	300/1334	90/400	72

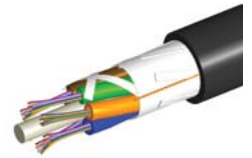

LSZH Indoor/Outdoor Loose Tube Cables

Material ID	Product Number	Fiber Count	Outer Diameter inch/mm	Min. Bend Radius		Max Tensile Load lbs./Newton	Crush Resistance	Weight
				Loaded inch/cm	Unloaded inch/cm			kg/km
Z60091827	Z006IN5LF06BK/20G	6	.43/11.0	5.2/13.1	10.2/26.1	607/2700	800	127
Z60091835	Z012IN5LF12BK/20G	12	.43/11.0	5.2/13.1	10.2/26.1	607/2700	800	127
Z60091843	Z024IN5LF12BK/20G	24	.43/11.0	5.2/13.1	10.2/26.1	607/2700	800	127
Z60122119	Z048IN5LF12BK/20G	48	.43/11.0	5.2/13.1	10.2/26.1	607/2700	800	127
Z60100198	Z072IN5LF12BK/20G	72	.43/11.0	5.2/13.1	10.2/26.1	607/2700	800	127
Z60091728	Z006IN8WF06BK/20G	6	.43/11.0	5.2/13.1	10.2/26.1	607/2700	800	127
Z60091736	Z012IN8WF12BK/20G	12	.43/11.0	5.2/13.1	10.2/26.1	607/2700	800	127
Z60091744	Z024IN8WF12BK/20G	24	.43/11.0	5.2/13.1	10.2/26.1	607/2700	800	127
Z60091769	Z048IN8WF12BK/20G	48	.43/11.0	5.2/13.1	10.2/26.1	607/2700	800	127
Z60091785	Z072IN8WF12BK/20G	72	.43/11.0	5.2/13.1	10.2/26.1	607/2700	800	127
Z60091819	Z144IN8WF12BK/20G	144	.58/14.7	6.4/16.2	12.8/32.4	607/2700	800	225
Z60124685	Z006IN6FF06BK/20G	6	.43/11.0	5.2/13.1	10.2/26.1	607/2700	800	127
Z60111286	Z012IN6FF12BK/20G	12	.43/11.0	5.2/13.1	10.2/26.1	607/2700	800	127



LSZH Indoor/Outdoor HTS Stranded Loose Tube All Dielectric Cables (Rodent Resistant)

Material ID	Product Number	Fiber Count	Outer Diameter inch/mm	Min. Bend Radius		Max Tensile Load lbs./Newton	Crush Resistance	Weight
				Loaded inch/cm	Unloaded inch/cm			kg/km
Z60100727	Z012IN8WF12BK/20G/HTS	12	0.51/13.1	10.3/26.2	5.1/13.1	1000/4448*	-	169
Z60100735	Z024IN8WF12BK/20G/HTS	24	0.51/13.1	10.3/26.2	5.1/13.1	1000/4448*	-	169
Z60100743	Z048IN8WF12BK/20G/HTS	48	0.51/13.1	10.3/26.2	5.1/13.1	1000/4448*	-	169
Z60100750	Z072IN8WF12BK/20G/HTS	72	.51/13.1	10.3/26.2	5.1/13.1	1000/4448*	-	169
Z60100768	Z144IN8WF12BK/20G/HTS	144	.64/16.2	12.7/32.4	6.4/16.2	1000/4448*	-	256

* Installation Load lbs./Newton

Outside Plant Cables

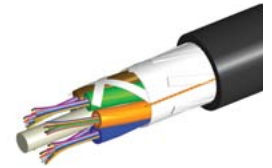

All Dry Outside Stranded Loose Tube Non-Armored All Dielectric Gel-free Buffer Tube Cables

Material ID	Product Number	Fiber Count	Outer Diameter inch/mm	Min. Bend Radius		Max Tensile Load lbs./Newton	Crush Resistance	Weight
				Loaded inch/cm	Unloaded inch/cm			kg/km
760054270	D006IN-5KF06NS	6	.40/10.2	8.0/20.4	4.0/10.2	607/2700	440	66
760054288	D012IN-5KF12NS	12	.40/10.2	8.0/20.4	4.0/10.2	607/2700	440	66
760054296	D024IN-5KF12NS	24	.40/10.2	8.0/20.4	4.0/10.2	607/2700	440	66
760054312	D048IN-5KF12NS	48	.40/10.2	8.0/20.4	4.0/10.2	607/2700	440	66
760054338	D072IN-5KF12NS	72	.42/10.6	8.3/21.2	4.2/10.6	607/2700	440	73
760054163	D006IN-5LF06NS	6	.40/10.2	8.0/20.4	4.0/10.2	607/2700	440	66
760054171	D012IN-5LF12NS	12	.40/10.2	8.0/20.4	4.0/10.2	607/2700	440	66
760054189	D024IN-5LF12NS	24	.40/10.2	8.0/20.4	4.0/10.2	607/2700	440	66
760054205	D048IN-5LF12NS	48	.40/10.2	8.0/20.4	4.0/10.2	607/2700	440	66
760054221	D072IN-5LF12NS	72	.42/10.6	8.3/21.2	4.2/10.6	607/2700	440	73
760054056	D006IN-5MF06NS	6	.40/10.2	8.0/20.4	4.0/10.2	607/2700	440	66
760054064	D012IN-5MF12NS	12	.40/10.2	8.0/20.4	4.0/10.2	607/2700	440	66
760054072	D024IN-5MF12NS	24	.40/10.2	8.0/20.4	4.0/10.2	607/2700	440	66
760054098	D048IN-5MF12NS	48	.40/10.2	8.0/20.4	4.0/10.2	607/2700	440	66
760054114	D072IN-5MF12NS	72	.42/10.6	8.3/21.2	4.2/10.6	607/2700	440	73
760053835	D006IN-8WF06NS	6	.40/10.2	8.0/20.4	4.0/10.2	607/2700	440	66
760053843	D012IN-8WF12NS	12	.40/10.2	8.0/20.4	4.0/10.2	607/2700	440	66
760053850	D024IN-8WF12NS	24	.40/10.2	8.0/20.4	4.0/10.2	607/2700	440	66
760053876	D048IN-8WF12NS	48	.40/10.2	8.0/20.4	4.0/10.2	607/2700	440	66
760053892	D072IN-8WF12NS	72	.42/10.6	8.3/21.2	4.2/10.6	607/2700	440	73
760053918	D-144IN-8WF12NS	144	.62/15.8	12.4/31.6	6.2/15.8	607/2700	440	159
760053926	D-288IN-8WF12NS	288	.71/18.2	14.3/36.4	7.1/18.2	607/2700	440	181
760053942	D006IN-6FF06NS	6	.40/10.2	8.0/20.4	4.0/10.2	607/2700	440	66
760053959	D012IN-6FF12NS	12	.40/10.2	8.0/20.4	4.0/10.2	607/2700	440	66
760053967	D024IN-6FF12NS	24	.40/10.2	8.0/20.4	4.0/10.2	607/2700	440	66
760053983	D048IN-6FF12NS	48	.40/10.2	8.0/20.4	4.0/10.2	607/2700	440	66
760054007	D072IN-6FF12NS	72	.42/10.6	8.3/21.2	4.2/10.6	607/2700	440	73
760054023	D-144IN-6FF12NS	144	.62/15.8	12.4/31.6	6.2/15.8	607/2700	440	159
760054031	D-288IN-6FF12NS	288	.71/18.2	14.3/36.4	7.1/18.2	607/2700	440	181

Outside Plant Cables

Fiber Solutions



All Dry Outside Plant Stranded Loose Tube Armored Gel-free Buffer Tubes

Material ID	Product Number	Fiber Count	Outer Diameter inch/mm	Min. Bend Radius		Max Tensile Load lbs./Newton	Crush Resistance	Weight
				Loaded inch/cm	Unloaded inch/cm			kg/km
Z60053728	D006IA-5KF06NS	6	.46/11.6	9.1/23.2	4.6/11.6	607/2700	440	116
Z60053736	D012IA-5KF12NS	12	.46/11.6	9.1/23.2	4.6/11.6	607/2700	440	116
Z60053744	D024IA-5KF12NS	24	.46/11.6	9.1/23.2	4.6/11.6	607/2700	440	116
Z60053769	D048IA-5KF12NS	48	.46/11.6	9.1/23.2	4.6/11.6	607/2700	440	116
Z60053785	D072IA-5KF12NS	72	.47/12.1	9.5/24.2	4.7/12.1	607/2700	440	123
Z60053611	D006IA-5LF06NS	6	.46/11.6	9.1/23.2	4.6/11.6	607/2700	440	116
Z60053629	D012IA-5LF12NS	12	.46/11.6	9.1/23.2	4.6/11.6	607/2700	440	116
Z60053637	D024IA-5LF12NS	24	.46/11.6	9.1/23.2	4.6/11.6	607/2700	440	116
Z60053652	D048IA-5LF12NS	48	.46/11.6	9.1/23.2	4.6/11.6	607/2700	440	116
Z60053678	D072IA-5LF12NS	72	.47/12.1	9.5/24.2	4.7/12.1	607/2700	440	123
Z60053504	D006IA-5MF06NS	6	.46/11.6	9.1/23.2	4.6/11.6	607/2700	440	116
Z60053512	D012IA-5MF12NS	12	.46/11.6	9.1/23.2	4.6/11.6	607/2700	440	116
Z60053520	D024IA-5MF12NS	24	.46/11.6	9.1/23.2	4.6/11.6	607/2700	440	116
Z60053546	D048IA-5MF12NS	48	.46/11.6	9.1/23.2	4.6/11.6	607/2700	440	116
Z60053561	D072IA-5MF12NS	72	.47/12.1	9.5/24.2	4.7/12.1	607/2700	440	123
Z60053272	D006IA-8WF06NS	6	.46/11.6	9.1/23.2	4.6/11.6	607/2700	440	116
Z60053280	D012IA-8WF12NS	12	.46/11.6	9.1/23.2	4.6/11.6	607/2700	440	116
Z60053298	D024IA-8WF12NS	24	.46/11.6	9.1/23.2	4.6/11.6	607/2700	440	116
Z60053314	D048IA-8WF12NS	48	.46/11.6	9.1/23.2	4.6/11.6	607/2700	440	116
Z60053330	D072IA-8WF12NS	72	.47/12.1	9.5/24.2	4.7/12.1	607/2700	440	123
Z60053355	D144IA-8WF12NS	144	.68/17.3	13.6/34.6	6.8/17.3	607/2700	440	231
Z60053363	D288IA-8WF12NS	288	.77/19.7	15.5/39.4	7.7/19.7	607/2700	440	264
Z60053389	D006IA-6FF06NS	6	.46/11.6	9.1/23.2	4.6/11.6	607/2700	440	116
Z60053397	D012IA-6FF12NS	12	.46/11.6	9.1/23.2	4.6/11.6	607/2700	440	116
Z60053405	D024IA-6FF12NS	24	.46/11.6	9.1/23.2	4.6/11.6	607/2700	440	116
Z60053421	D048IA-6FF12NS	48	.46/11.6	9.1/23.2	4.6/11.6	607/2700	440	116
Z60053447	D072IA-6FF12NS	72	.47/12.1	9.5/24.2	4.7/12.1	607/2700	440	123
Z60053470	D144IA-6FF12NS	144	.68/17.3	13.6/34.6	6.8/17.3	607/2700	440	231
Z60053488	D288IA-6FF12NS	288	.77/19.7	15.5/39.4	7.7/19.7	607/2700	440	264

Outside Plant Cables

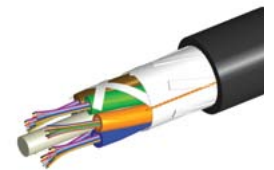

Outside Plant Arid-Core® Mini Stranded Loose Tube Non-Armored All Dielectric

Material ID	Product Number	Fiber Count	Outer Diameter inch/mm	Min. Bend Radius		Max Tensile Load lbs./Newton	Crush Resistance	Weight kg/km
				Loaded inch/cm	Unloaded inch/cm			
760128280	00124N5KF12NS/20T	12	.37/9.5	7.5/19.0	3.7/9.5	607/2700	440	72
760128298	00244N5KF12NS/20T	24	.37/9.5	7.5/19.0	3.7/9.5	607/2700	440	72
760128306	0-1444N5KF12NS/20T	144	.52/13.3	10.4/26.5	5.2/13.3	607/2700	440	138
760128256	00124N5LF12NS/20T	12	.37/9.5	7.5/19.0	3.7/9.5	607/2700	440	72
760128264	00244N5LF12NS/20T	24	.37/9.5	7.5/19.0	3.7/9.5	607/2700	440	72
760128272	0-1444N5LF12NS/20T	144	.52/13.3	10.4/26.5	5.2/13.3	607/2700	440	138
760128223	00124N8WF12NS/20T	12	.37/9.5	7.5/19.0	3.7/9.5	607/2700	440	72
760128231	00244N8WF12NS/20T	24	.37/9.5	7.5/19.0	3.7/9.5	607/2700	440	72
760128249	0-1444N8WF12NS/20T	144	.52/13.3	10.4/26.5	5.2/13.3	607/2700	440	138

Outside Plant Arid-Core® Drop Armored Cables

Material ID	Product Number	Fiber Count	Outer Diameter inch/mm	Min. Bend Radius		Max Tensile Load lbs./Newton	Crush Resis- tance	Weight kg/km
				Loaded inch/cm	Unloaded inch/cm			
76014662	O-004-DA-5L-F04NS	4	.31/8.0	4.7/12.0	3.1/8.0	300/1334	-	69
760146670	O-004-DA-8W-F04NS	4	.31/8.0	4.7/12.0	3.1/8.0	300/1334	-	69
760135467	O-006-DA-8W-F06NS	6	.31/8.0	4.7/12.0	3.1/8.0	300/1334	-	69
760135517	O-012-DA-8W-F12NS	12	.31/8.0	4.7/12.0	3.1/8.0	300/1334	-	69



Enterprise

SYSTIMAX 360G2

Fiber Connectivity



SYSTIMAX 360G2 Modular Fiber Shelves & Panels 1U, 2U & 4U

MATERIAL ID	PRODUCT NUMBER	DESCRIPTION
760173690	360G2-4U-MOD-UHD	360G2 4U Sliding Shelf, accepts 24 modules
760173682	360G2-2U-MOD-UHD	360G2 2U Sliding Shelf, accepts 12 modules
760173674	360G2-1U-MOD-UHD	360G2 1U Sliding Shelf, accepts 4 modules
760193870	360G2-4U-MOD-FX	360G2 4U Fixed modular cassette shelf, accepts 12 360DM, 360DP or 360G2 modular cassettes
760193888	360G2-4U-MOD-FX-16	360G2 4U Fixed modular cassette shelf, accepts 16 360DM, 360DP or 360G2 modular cassettes
760193896	360G2-4U-MOD-SD	360G2 4U Sliding modular cassette shelf, accepts 12 360DM, 360DP or 360G2 modular cassettes
760193847	360G2-2U-MOD-FX	360G2 2U Fixed modular cassette shelf, accepts 8 360DM, 360DP or 360G2 modular cassettes
760193854	360G2-2U-MOD-SD	360G2 2U Sliding modular cassette shelf, accepts 8 360DM, 360DP or 360G2 modular cassettes
760193763	360G2-1U-MOD-FX	360G2 1U Fixed modular cassette shelf, accepts 4 360DM, 360DP or 360G2 modular cassettes
760193771	360G2-1U-MOD-SD	360G2 1U Sliding modular cassette shelf, accepts 4 360DM, 360DP or 360G2 modular cassettes
760193904	360G2-1U-MOD-IS	360G2 1U Fixed modular cassette shelf, accepts 4 360DM, 360DP or 360G2 modular cassettes
760193821	360G2-1U-UP-FX	SYSTIMAX 360G2 1U faceplate shelf
760193839	360G2-1U-UP-SD	SYSTIMAX 360G2 1U sliding shelf
760193755	360MP-1U-PANEL	1U Panel, accepts 4 360DM or 360DP components
760193920	360MP-2U-PANEL	2U Panel, accepts 8 360DM or 360DP components
760193862	360MP-4U-PANEL	4U Panel, accepts 16 360DM or 360DP components
760113001	360MP-1UA	Angled 360MP 1U Panel Angled, accepts 4 360DM or 360DP components

SYSTIMAX 360G2 Accessories

MATERIAL ID	PRODUCT NUMBER	DESCRIPTION
760193938	360G2-1U-TROUGH	360 1U Trough Assembly Kit
760193946	360G2-2U-TROUGH	360 2U Trough Assembly Kit
760101410	360G2-4U-FLK	360 Flip Label Kit, 4U Shelf
760105676	360G2-1U-LABEL	360G2 Flip Label Kit, 1U Trough
760110098	CMB-360MP-1U	Hardware kit for 360MP-1U and 360MP-1U-ANGLED panels for mounting to "L" shaped equipment rail



InstaPATCH 360 Modules

MATERIAL ID	PRODUCT NUMBER	DESCRIPTION	iPatch READY
760109884	360DM-24LC-LS	InstaPATCH 360 Module, 24LC-LazrSPEED	Yes
760109892	360DM-24LC-SM	InstaPATCH 360 Module, 24LC-TeraSPEED	Yes
760109900	360DM-24LC-MM	InstaPATCH 360 Module, 24LC-OptiSPEED	Yes
760109918	360DM-24LCA-SM	InstaPATCH 360 Module, 24LCA-TeraSPEED	No
760109926	360DM-12LC-LS	InstaPATCH 360 Module, 12LC-LazrSPEED	Yes
760109934	360DM-12LC-SM	InstaPATCH 360 Module, 12LC-TeraSPEED	Yes
760109942	360DM-12LC-MM	InstaPATCH 360 Module, 12LC-OptiSPEED	Yes
760109959	360DM-12LCA-SM	InstaPATCH 360 Module, 12LCA-TeraSPEED	Yes
760109967	360DM-12SC-LS	InstaPATCH 360 Module, 12SC-LazrSPEED	No
760109975	360DM-12SC-SM	InstaPATCH 360 Module, 12SC-TeraSPEED	No
760109983	360DM-12SC-MM	InstaPATCH 360 Module, 12SC-OptiSPEED	No
760109991	360DM-12SCA-SM	InstaPATCH 360 Module, 12SCA-TeraSPEED	No

SYSTIMAX 360G2



SYSTIMAX 360G2 Modular Cartridges with Pigtails

MATERIAL ID	PRODUCT NUMBER	DESCRIPTION	COLOR
Z60109470	360G2 Cartridge 12-LC-LS-AQ-Pigtails	w/Pigtails, 360G2 Cartridge 12 LC LazrSPEED, iPatch Ready	Aqua
Z60109488	360G2 Cartridge 12-LC-MM-BG-Pigtails	360G2 Cartridge 12 LC OptiSPEED, w/Pigtails, iPatch Ready	Beige
Z60109496	360G2 Cartridge 12-LC-SM-BL-Pigtails	360G2 Cartridge 12 LC TeraSPEED, w/Pigtails, iPatch Ready	Blue
Z60109504	360G2 Cartridge 12-LCA-SM-GR-Pigtails	360G2 Cartridge 12 LCA TeraSPEED, w/Pigtails, iPatch Ready	Green
Z60109512	360G2 Cartridge 6-SC-LS-AQ-Pigtails A	360G2 Cartridge 6 SC LazrSPEED, w/Pigtails A	Aqua
Z60109520	360G2 Cartridge 6-SC-LS-AQ-Pigtails B	360G2 Cartridge 6 SC LazrSPEED, w/Pigtails B	Aqua
Z60109538	360G2 Cartridge 6-SC-MM-BG-Pigtails A	360G2 Cartridge 6 SC OptiSPEED, w/Pigtails A	Beige
Z60109546	360G2 Cartridge 6-SC-MM-BG-Pigtails B	360G2 Cartridge 6 SC OptiSPEED, w/Pigtails B	Beige
Z60109553	360G2 Cartridge 6-SC-SM-BL-Pigtails A	360G2 Cartridge 6 SC TeraSPEED, w/Pigtails A	Blue
Z60109561	360G2 Cartridge 6-SC-SM-BL-Pigtails B	360G2 Cartridge 6 SC TeraSPEED, w/Pigtails B	Blue
Z60109579	360G2 Cartridge 6-SCA-SM-GR-Pigtails A	360G2 Cartridge 6 SCA TeraSPEED, w/Pigtails A	Green
Z60109587	360G2 Cartridge 6-SCA-SM-GR-Pigtails B	360G2 Cartridge 6 SCA TeraSPEED, w/Pigtails B	Green
Z60109603	360G2 Cartridge 6-ST-LS-AQ-Pigtails A	360G2 Cartridge 6 ST LazrSPEED, w/Pigtails A	Aqua
Z60109611	360G2 Cartridge 6-ST-LS-AQ-Pigtails B	360G2 Cartridge 6 ST LazrSPEED, w/Pigtails B	Aqua
Z60109629	360G2 Cartridge 6-ST-MM-BG-Pigtails A	360G2 Cartridge 6 ST OptiSPEED, w/Pigtails A	Beige
Z60109637	360G2 Cartridge 6-ST-MM-BG-Pigtails B	360G2 Cartridge 6 ST OptiSPEED, w/Pigtails B	Beige
Z60109645	360G2 Cartridge 6-ST-SM-BL-Pigtails A	360G2 Cartridge 6 ST TeraSPEED, w/Pigtails A	Blue
Z60109652	360G2 Cartridge 6-ST-SM-BL-Pigtails B	360G2 Cartridge 6 ST TeraSPEED, w/Pigtails B	Blue
Z60109462	360G2-MOD-BLANK-4PK	360G2 Mod Panel Blank (4 Panels)	

SYSTIMAX 360G2 Modular Cartridges without Pigtails

MATERIAL ID	PRODUCT NUMBER	DESCRIPTION	COLOR
Z60109256	360G2 Cartridge 12-LC-LS-AQ	360G2 Cartridge 12 LC LazrSPEED, iPatch Ready	Aqua
Z60109264	360G2 Cartridge 12-LC-MM-BG	360G2 Cartridge 12 LC OptiSPEED, iPatch Ready	Beige
Z60109272	360G2 Cartridge 12-LC-SM-BL	360G2 Cartridge 12 LC TeraSPEED, iPatch Ready	Blue
Z60109280	360G2 Cartridge 12-LCA-SM-GR	360G2 Cartridge 12 LCA TeraSPEED, iPatch Ready	Green
Z60109298	360G2 Cartridge 6-SC-LS-AQ	360G2 Cartridge 6 SC LazrSPEED	Aqua
Z60109306	360G2 Cartridge 6-SC-MM-BG	360G2 Cartridge 6 SC OptiSPEED	Beige
Z60109314	360G2 Cartridge 6-SC-SM-BL	360G2 Cartridge 6 SC TeraSPEED	Blue
Z60109322	360G2 Cartridge 6-SCA-SM-GR	360G2 Cartridge 6 SCA TeraSPEED	Green
Z60109330	360G2 Cartridge 6-ST-LS-AQ	360G2 Cartridge 6 ST LazrSPEED	Aqua
Z60109348	360G2 Cartridge 6-ST-MM-BG	360G2 Cartridge 6 ST OptiSPEED	Beige
Z60109355	360G2 Cartridge 6-ST-SM-BL	360G2 Cartridge 6 ST TeraSPEED	Blue



SYSTIMAX 360G2 Modular Distribution Panels

MATERIAL ID	PRODUCT NUMBER	DESCRIPTION
Z60115907	360DP-24LC-LS	360 Distribution Panel 24 LC LazrSPEED, iPatch Ready
Z60115923	360DP-24LC-MM	360 Distribution Panel 24 LC OptiSPEED, iPatch Ready
Z60115915	360DP-24LC-SM	360 Distribution Panel 24 LC TeraSPEED, iPatch Ready
Z60115931	360DP-24LCA-SM	360 Distribution Panel 24 LCA TeraSPEED
Z60109363	360DP-12LC-LS	360 Distribution Panel 12 LC LazrSPEED, iPatch Ready
Z60109371	360DP-12LC-MM	360 Distribution Panel 12 LC OptiSPEED, iPatch Ready
Z60109389	360DP-12LC-SM	360 Distribution Panel 12 LC TeraSPEED, iPatch Ready
Z60109751	360DP-12LCA-SM	360 Distribution Panel 12 LCA TeraSPEED, iPatch Ready
Z60109397	360DP-6SC-LS	360 Distribution Panel 6 SC LazrSPEED
Z60109405	360DP-6SC-MM	360 Distribution Panel 6 SC OptiSPEED
Z60109413	360DP-6SC-SM	360 Distribution Panel 6 SC TeraSPEED
Z60109769	360DP-6SCA-SM	360 Distribution Panel 6 SCA TeraSPEED
Z60109421	360DP-6STLS	360 Distribution Panel 6 ST LazrSPEED
Z60109439	360DP-6STMM	360 Distribution Panel 6 ST OptiSPEED
Z60109447	360DP-6STSM	360 Distribution Panel 6 ST TeraSPEED
Z60107490	360DP-2MPO	360 Distribution Panel 2 MPO
Z60107508	360DP-4MPO	360 Distribution Panel 4 MPO
Z60107516	360DP-6MPO	360 Distribution Panel 6 MPO
Z60107524	360DP-8MPO	360 Distribution Panel 8 MPO, iPatch Ready

Fiber Optic Patch Cords Configurator

1	2	3	4	5	6	7	8	9	10	11	12	13	14-16	
F	D	X	L	1	L	1	2	1	-	M	X	F	010	
Prefix FD Jumper-Plenum FE Jumper-Rise FF Jumper-LSZH	Fiber Type X LazrSPEED 550/Multimode M OptiSPEED Multimode W TeraSPEED Single-mode		Connector One LC LC Standard SC SC Standard ST STII LA LC Angled SA SC Angled L1 LC Keyed Red L2 LC Keyed Yellow L3 LC Keyed Blue L4 LC Keyed Green L5 LC Keyed Orange L6 LC Keyed Slate L7 LC Keyed Brown L8 LC Keyed Aqua L9 LC Keyed Rose LV LC Keyed Violet LU LC Uniboot			Connector Two LC LC Standard SC SC Standard ST STII LA LC Angled SA SC Angled L1 LC Keyed Red L2 LC Keyed Yellow L3 LC Keyed Blue L4 LC Keyed Green L5 LC Keyed Orange L6 LC Keyed Slate L7 LC Keyed Brown L8 LC Keyed Aqua L9 LC Keyed Rose LV LC Keyed Violet MJ MTRJ FC FC Standard FA FC Angled LU LC Uniboot			Fiber Count 1 1 Fiber 2 2 Fiber	Cordage Size 2 1.6mm Simplex 3 3.0mm Simplex 4 1.6mm Zipcord 5 3.0mm Zipcord 6 2.0mm MP IC*	Jacket Color A Blue B Orange C Green D Brown E Slate G Red H Black J Yellow K Violet L Rose M Aqua	UOM F Feet M Meter	Breakout Length X No Breakout	Length 2 - 999 Feet 1 - 999 Meters

* This for use on Uniboot Connector Assemblies only

Cord Color Options: 1=BK (Black), 2=LB (Light Blue), 3=DG (Dark Gray), 4=GN (Spring Green), 6=OR (Orange), 7=RD (Red), 8=WH (White), 9=YL (Yellow), B=L (Lilac), C=SL (Slate), Z=BL (Blue)

Fiber Optic Pigtails

Fiber Optic Pigtails Configurator

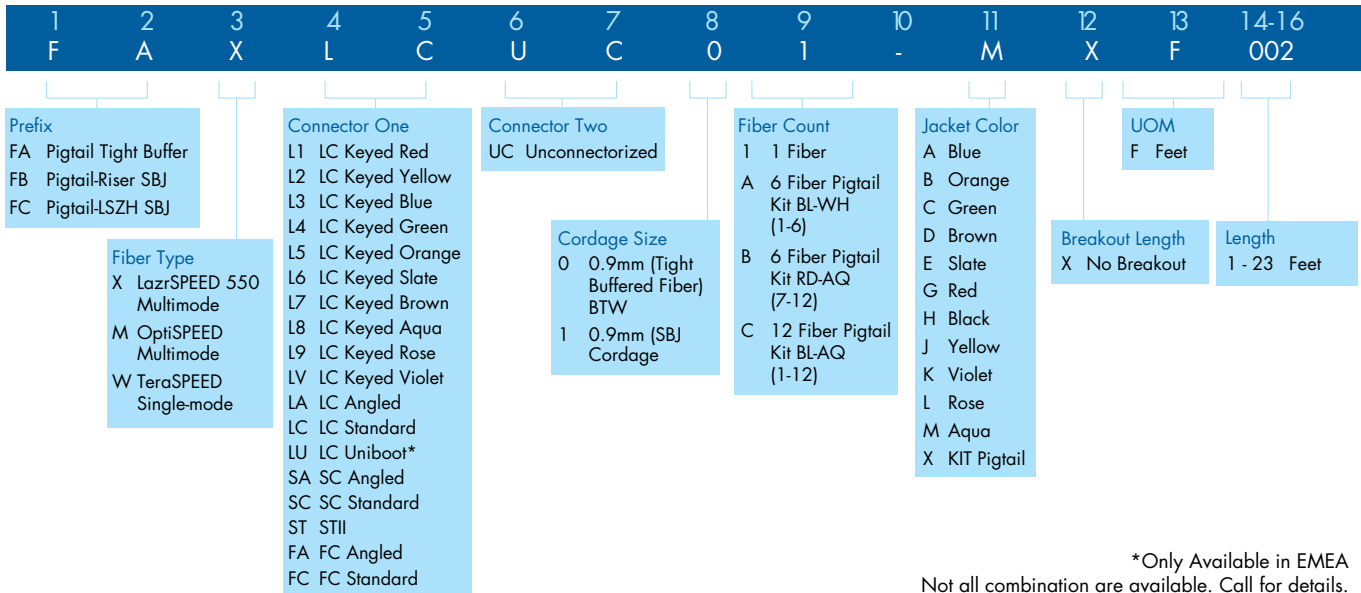

Trunk Cables and Trunk Extensions

InstaPATCH® 360 Trunk Cables and Trunk Extension Configurator

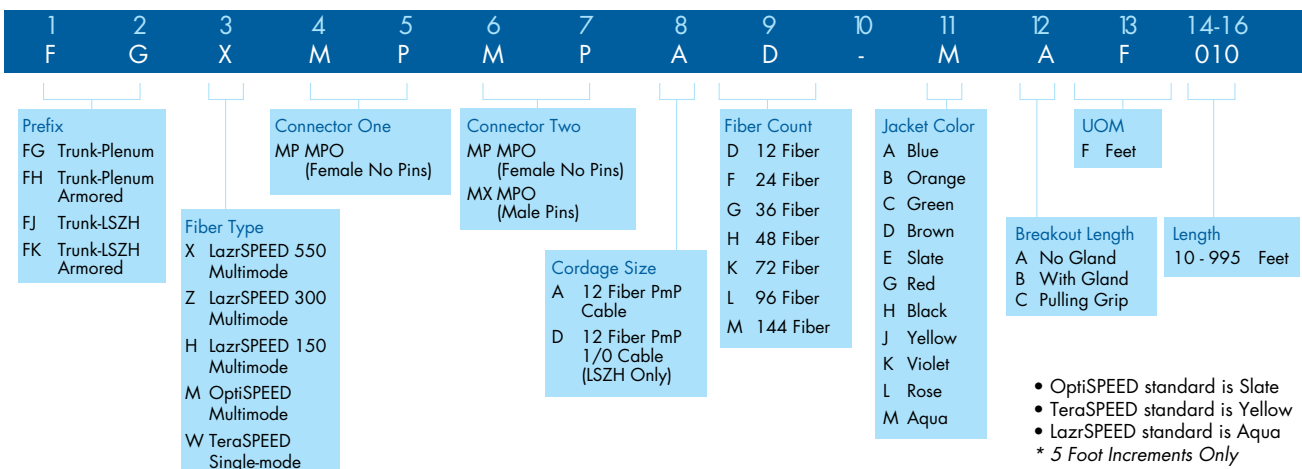

InstaPATCH® 360 Ruggedized Fanout Cable Configurator

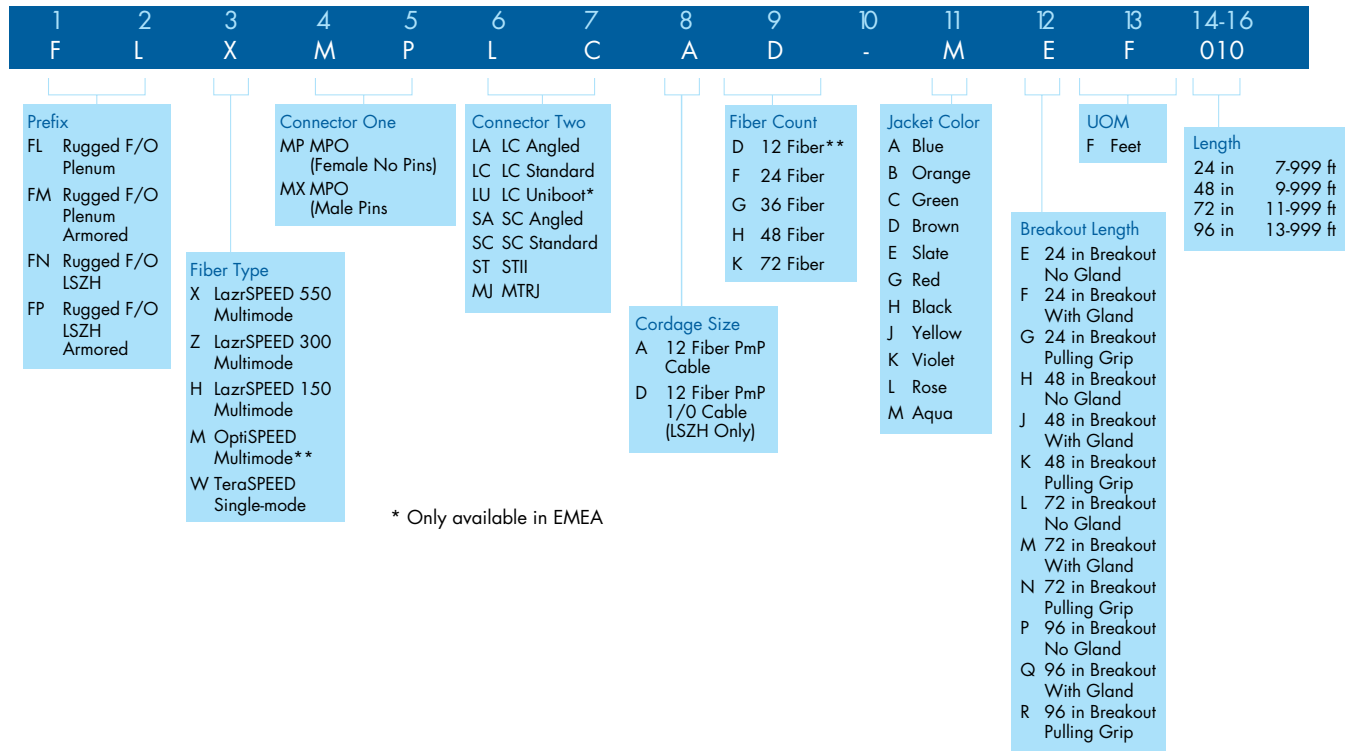

InstaPATCH® 360 Array Fanout Cables

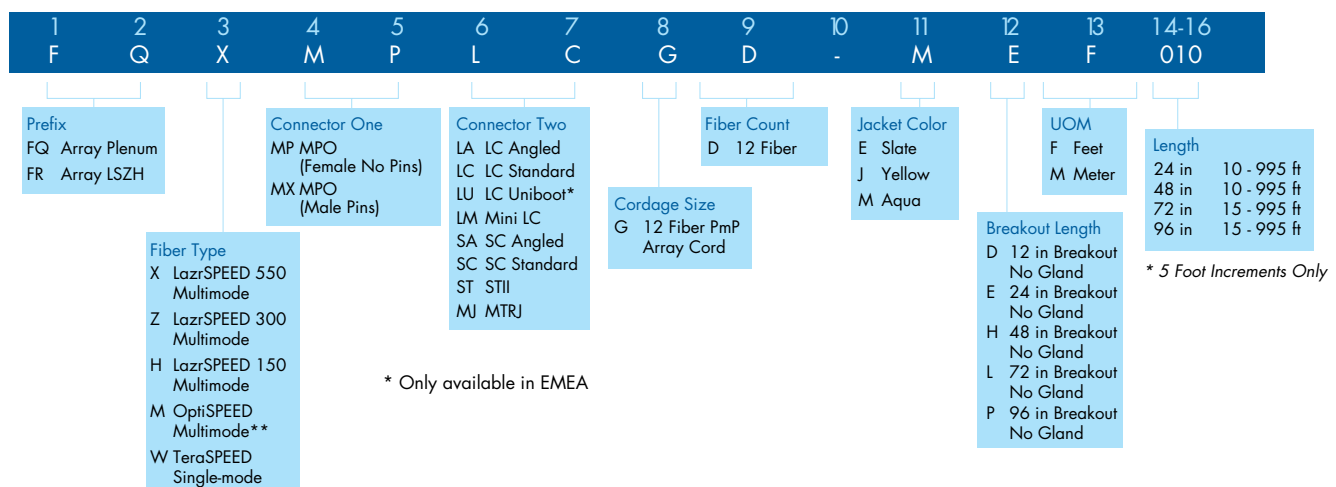

Array Cords

InstaPATCH® 360 Array Cords Configurator

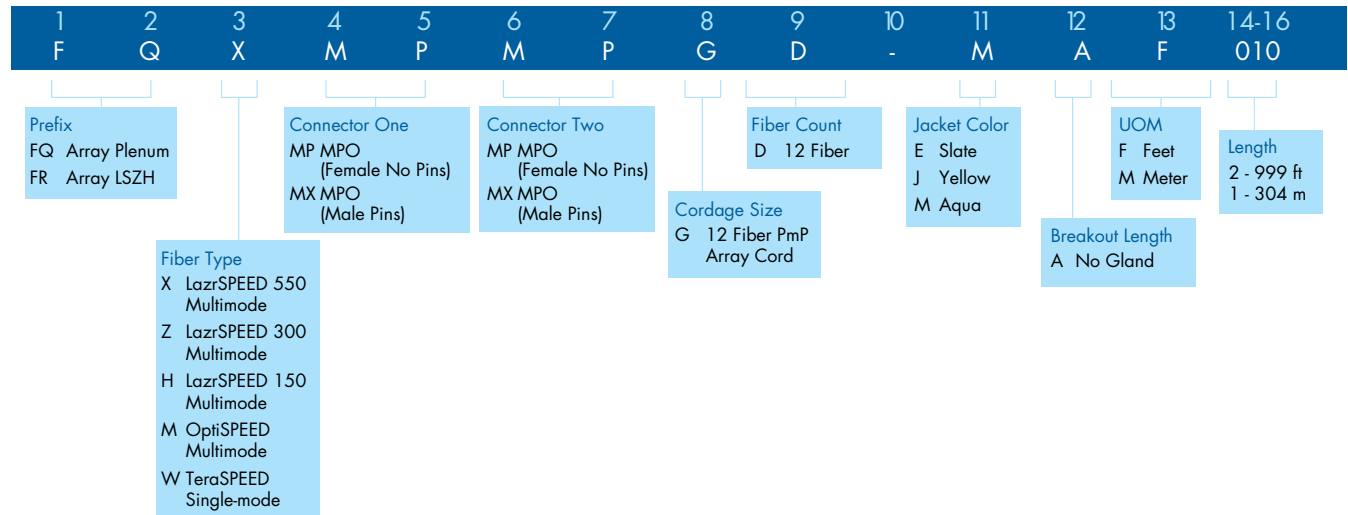



EZ-LC Connectors®

MATERIAL ID	PRODUCT NUMBER	DESCRIPTION	FIBER TYPE	COLOR	QTY./PKG.
Z60034181	MFC-LCR-09-BG	BTW LC Connector, Pre-radiused, for 0.9mm Fiber	MM	Beige	1
Z60034199	SFC-LCR-09-BL	BTW LC Connector, Pre-radiused, for 0.9mm Fiber	SM	Blue	1
Z60034140	MFC-LCR-16-BG	LC Connector, Pre-radiused, Simplex, for 1.6mm Cordage	MM	Beige	1
Z60111476	MFC-LCR-30-BG	LC Connector, Pre-radiused, Simplex, for 3.0mm Cordage	MM	Beige	1
Z60034173	SFC-LCR-16-BL	LC Connector, Pre-radiused, Simplex, for 1.6mm Cordage	SM	Blue	1
Z60111492	SFC-LCR-30-BL	LC Connector, Pre-radiused, Simplex, for 3.0mm Cordage	SM	Blue	1
Z60034157	MDC-LCR-16-BG	LC Connector, Pre-radiused, Duplex, for 1.6mm Cordage	MM	Beige	2
Z60111518	MDC-LCR-30-BG	LC Connector, Pre-radiused, Duplex, for 3.0mm Cordage	MM	Beige	2
Z60091439	SDC-LCR-16-BL	LC Connector, Pre-radiused, Duplex, for 1.6mm Cordage	SM	Blue	2
Z60111534	SDC-LCR-30-BL	LC Connector, Pre-radiused, Duplex, for 3.0mm Cordage	SM	Blue	2

EZ-SC Connectors®



MATERIAL ID	PRODUCT NUMBER	DESCRIPTION	FIBER TYPE	COLOR	QTY./PKG.
Z60007070	MFC-SCR-09-BG	BTW SC Connector, Pre-radiused, for 0.9mm Fiber	MM	Beige	1
Z60007112	SFC-SCR-09-BL	BTW SC Connector, Pre-radiused, for 0.9mm Fiber	SM	Blue	1
Z60112227	MFC-SCR-16-BG	SC Connector, Pre-radiused, Simplex, for 1.6mm Cordage	MM	Beige	1
Z60007047	MFC-SCR-30-BG	SC Connector, Pre-radiused, Simplex, for 3.0mm Cordage	MM	Beige	1
Z60112243	SFC-SCR-16-BL	SC Connector, Pre-radiused, Simplex, for 1.6mm Cordage	SM	Blue	1
Z60007096	SFC-SCR-30-BL	SC Connector, Pre-radiused, Simplex, for 3.0mm Cordage	SM	Blue	1
Z60112268	MDC-SCR-16-BG	SC Connector, Pre-radiused, Duplex, for 1.6mm Cordage	MM	Beige	2
Z60112284	MDC-SCR-30-BG	SC Connector, Pre-radiused, Duplex, for 3.0mm Cordage	MM	Beige	2
Z60112300	SDC-SCR-16-BL	SC Connector, Pre-radiused, Duplex, for 1.6mm Cordage	SM	Blue	2
Z60112326	SDC-SCR-30-BL	SC Connector, Pre-radiused, Duplex, for 3.0mm Cordage	SM	Blue	2



EZ-ST Connectors®

MATERIAL ID	PRODUCT NUMBER	DESCRIPTION	FIBER TYPE	QTY./PKG.
Z00004328	MFC-STU	ST II Connector, Pre-radiused	MM	0.9/2.4/3.0 1
Z00004310	MFC-STU-100-BULK	ST II Connector, Pre-radiused	MM	0.9/2.4/3.0 100
Z00011067	SFC-STU	ST II Connector, Pre-radiused	SM	0.9/2.4/3.0 1
Z60113241	SFC-STU-100-BULK	ST II Connector, Pre-radiused	SM	0.9/2.4/3.0 100

QWIK Connectors® II



MATERIAL ID	PRODUCT NUMBER	DESCRIPTION
Z60117887	MFC-LCF-09-5X	QWIK II-LC BTW Connector, LazrSPEED
Z60117903	MFC-LCF-09-6X	QWIK II-LC BTW Connector, OptiSPEED
Z60117945	MFC-SCF-09-5X	QWIK II-SC BTW Connector, LazrSPEED
Z60117960	MFC-SCF-09-6X	QWIK II-SC BTW Connector, OptiSPEED
Z60118000	MFC-STF-09-5X	QWIK II-ST BTW Connector, LazrSPEED
Z60118026	MFC-STF-09-6X	QWIK II-ST BTW Connector, OptiSPEED
Z60117895	SFC-LCF-09-8X	QWIK II-LC BTW Connector, TeraSPEED
Z60184697	SFC-LCF-09-8A	QWIK II-LC/APC BTW Connector, TeraSPEED
Z60117952	SFC-SCF-09-8X	QWIK II-SC BTW Connector, TeraSPEED
Z60184689	SFC-SCF-09-8A	QWIK II-SC/APC BTW Connector, TeraSPEED
Z60118018	SFC-STF-09-8X	QWIK II-ST BTW Connector, TeraSPEED



LC Adapters

MATERIAL ID	PRODUCT NUMBER	DESCRIPTION	COLOR	QTY./PKG.
108622887	MFA-LC02-AQ	LC Adapter, Duplex, LazrSPEED	Aqua	1
700002355	MFA-LC02-BG	LC Adapter, Duplex, OptiSPEED	Beige	1
700002215	SFA-LC02-BL	LC Adapter, Duplex, TeraSPEED	Blue	1
760036301	AFA-LC02-GR	LC Adapter, Duplex, APC	Green	1
760025338	MFA-LC01-AQ	LC Adapter, Simplex, LazrSPEED	Aqua	1
700002173	MFA-LC01-BG	LC Adapter, Simplex, OptiSPEED	Beige	1
700002132	SFA-LC01-BL	LC Adapter, Simplex, TeraSPEED	Blue	1
760036293	AFA-LC01-GR	LC Adapter, Simplex, APC	Green	1



SC Adapters

MATERIAL ID	PRODUCT NUMBER	DESCRIPTION	COLOR	QTY./PKG.
108622895	MFA-SC02-AQ	SC Adapter, Duplex, LazrSPEED	Aqua	1
700004880	MFA-SC02-BG	SC Adapter, Duplex, OptiSPEED	Beige	1
700004815	SFA-SC02-BL	SC Adapter, Duplex, TeraSPEED	Blue	1
760036285	AFA-SC02-GR	SC Adapter, Duplex, APC	Green	1
760115543	MFA-SC01-AQ	SC Adapter, Simplex, LazrSPEED	Aqua	1
108223181	MFA-SC01-BG	SC Adapter, Simplex, OptiSPEED	Beige	1
700004807	SFA-SC01-BL	SC Adapter, Simplex, TeraSPEED	Blue	1
760036277	AFA-SC01-GR	SC Adapter, Simplex, APC	Green	1



ST Adapters

MATERIAL ID	PRODUCT NUMBER	DESCRIPTION	FIBER TYPE	QTY./PKG.
700011133	HFA-ST01	Hybrid ST Adapter, Hex Nut	SM	1
760000638	HFA-ST01-CMN	Hybrid ST Adapter, Circular Nut	SM	1



Enterprise

SYSTIMAX imVision®



SYSTIMAX imVision® Controller

MATERIAL ID	PRODUCT NUMBER	DESCRIPTION
760161380	360-iMV-CNTRLR	imVision Controller

SYSTIMAX imVision® System Manager Software

See eCatalog for our full offering of System Manager software.

iPatch® Infrastructure Management



iPatch® Infrastructure Management Copper Panels

MATERIAL ID	PRODUCT NUMBER	DESCRIPTION
760152363	360-iP-1100-E-GS6-1U-24	360 iPatch 1100GS6 24-Port Evolve Patch Panel
760152348	360-iP-1100-E-GS6-2U-48	360 iPatch 1100GS6 48-Port Evolve Patch Panel
760158642	360-iP-1100A-E-GS6-1U-24	360 iPatch 1100GS6 24-Port Evolve Angled Patch Panel
760158659	360-iP-1100A-E-GS6-2U-48	360 iPatch 1100GS6 48-Port Evolve Angled Patch Panel
760152355	360-iP-1100-E-GS3-1U-24	360 iPatch 1100GS3 24-Port Evolve Patch Panel
760152330	360-iP-1100-E-GS3-2U-48	360 iPatch 1100GS3 48-Port Evolve Patch Panel
760158626	360-iP-1100A-E-GS3-1U-24	360 iPatch 1100GS3 24-Port Evolve Angled Patch Panel
760158634	360-iP-1100A-E-GS3-2U-48	360 iPatch 1100GS3 48-Port Evolve Angled Patch Panel
760104992	360-iP-UP-KIT-1100-24	360 iPatch Upgrade Kit for 360 1100 24-Port Panel, 10 pack
760105015	360-iP-UP-KIT-1100-48	360 iPatch Upgrade Kit for 360 1100 48-Port Panel, 5 pack
760152280	360-iP-UP-KITE-24	360 iPatch Upgrade Kit for 360 Evolve 24-Port Panel, 10 Pack
760158600	360-iP-UP-KITAE-24	360 iPatch Angled Evolve Kit, 24-Port, 10 pack
760158618	360-iP-UP-KITAE-48	360 iPatch Angled Evolve Kit, 48-Port, 5 pack
760152298	360-iP-UP-KITE+PMAx-48	360 iPatch Upgrade Kit for 360 Evolve and PATCHMAX 48-Port Panels, 5 Pack
760130393	360-iP-PMAx-GS6-24	360 iPatch PATCHMAX GS6 24-Port Panel
760130401	360-iP-PMAx-GS6-48	360 iPatch PATCHMAX GS6 48-Port Panel
760123489	360-iP-PMAx-GS3-24	360 iPatch PATCHMAX GS3 24-Port Panel
760123497	360-iP-PMAx-GS3-48	360 iPatch PATCHMAX GS3 48-Port Panel
760152306	360-iP-UP-KITPMAx-2U-24	360 iPatch Upgrade Kit, PATCHMAX 24-Port, 2U
760163766	360-iP-1100-E-1U-BLANK	360 iPatch 1100 Evolve 24 Port, blank
760163774	360-iP-1100-E-2U-BLANK	360 iPatch 1100 Evolve 48 Port, blank
760163808	360-iP-1100A-E-1U-BLANK	360 iPatch 1100 Angled Evolve 24 Port, blank
760163816	360-iP-1100A-E-2U-BLANK	360 iPatch 1100 Angled Evolve 48 Port, blank
760152371	360-iP-M-E-HD6B-1U-24	360 iPatch Evolve High Density F/UTP Modular Panel, 24-Port
760152389	360-iP-M-E-HD6B-2U-48	360 iPatch Evolve High Density F/UTP Modular Panel, 48-Port
760158667	360-iP-MFTP-A-E-HD6B-1U-24	360 iPatch Evolve High Density F/UTP Angled Modular Panel, 24-Port
760158675	360-iP-MFTP-A-E-HD6B-2U-48	360 iPatch Evolve High Density F/UTP Angled Modular Panel, 48-Port
760163782	360-iP-MFTP-E-1U-BLANK	360 iPatch F/UTP Evolve 24 Port Panel, blank
760163790	360-iP-MFTP-E-2U-BLANK	360 iPatch F/UTP Evolve 48 Port Panel, blank
760163824	360-iP-MFTP-A-E-1U-BLANK	360 iPatch F/UTP Angled Evolve 24 Port Panel, blank
760163832	360-iP-MFTP-A-E-2U-BLANK	360 iPatch F/UTP Angled Evolve 48 Port Panel, blank

iPatch® Infrastructure Management



iPatch® Infrastructure Management Fiber Optic Shelves

MATERIAL ID	PRODUCT NUMBER	DESCRIPTION
760193805	360-iP-INSTA-LC-4LS	360 iPatch G2 LC Fiber Shelf InstaPATCH 360 LazrSPEED® Slide
760193813	360-iP-INSTA-LC-4TS	360 iPatch G2 LC Fiber Shelf InstaPATCH 360 TeraSPEED® Slide
760193789	360-iP-G2-1U-LC-FX	360 iPatch G2 LC Fiber Shelf, Fixed
760193797	360-iP-G2-1U-LC-SD	360 iPatch G2 Fiber Shelf, Slide
760105148	360-iP-UP-KIT-G2-LC	360 iPatch Upgrade Kit for 360G2-1U-MOD shelves with LC Cassettes
760168419	360G2-iP 1U 96F LC DP SD	360G2 iPatch 1U 96F-LC Distribution Panel, Sliding Shelf
760168435	360G2-iP 1U 96F LC DM LS SD	360G2 iPatch 1U 96F-LC Distribution Module, LazrSPEED, Sliding Shelf
760188326	360G2-iP 1U 96F LC DM TS SD	360G2 iPatch 1U 96F-LC Distribution Module, TeraSPEED, Sliding Shelf
760188342	360G2-iP 1U 96F LC DM LS UHD	360G2 iPatch 1U 96F-LC Distribution Module, LazrSPEED, UHD Shelf
760188359	360G2-iP 1U 96F LC DM TS UHD	360G2 iPatch 1U 96F-LC Distribution Module, TeraSPEED, UHD Shelf
760188375	360G2-iP 2U 192F LC DP SD	360G2 iPatch 2U 192F-LC Distribution Panel, Sliding Shelf
760188383	360G2-iP 2U 192F LC DM LS SD	360G2 iPatch 2U 192F-LC Distribution Module, LazrSPEED, Sliding Shelf
760188391	360G2-iP 2U 192F LC DM TS SD	360G2 iPatch 2U 192F-LC Distribution Module, TeraSPEED, Sliding Shelf
760188417	360G2-iP 2U 288F LC DM LS UHD	360G2 iPatch 2U 288F-LC Distribution Module, LazrSPEED, UHD Shelf
760188425	360G2-iP 2U 288F LC DM TS UHD	360G2 iPatch 2U 288F-LC Distribution Module, TeraSPEED, UHD Shelf
760169144	360G2-iP 1U 32 MPO DP SD	360G2 iPatch 1U 32-MPO Distribution Panel, Sliding Shelf
760169177	360G2-iP 1U 32 MPO DP UHD	360G2 iPatch 1U 32-MPO Distribution Panel, UHD Shelf
760169185	360G2-iP 2U 64 MPO DP SD	360G2 iPatch 2U 64-MPO Distribution Panel, Sliding Shelf
760169193	360G2-iP 2U 96 MPO DP UHD	360G2 iPatch 2U 96-MPO Distribution Panel, UHD Shelf
760168443	360G2-iP 96F LC SD KIT-5PK	360G2 iPatch 96F-LC, Sliding Shelf 5PK Kit
760172221	360G2-iP 96F LC UHD KIT-6PK	360G2 iPatch 96F-LC, UHD Shelf 6PK Kit
760169151	360G2-iP 32 MPO SD KIT-5PK	360G2 iPatch 32-MPO, Sliding Shelf 5PK Kit
760169169	360G2-iP 32 MPO UHD KIT-6PK	360G2 iPatch 32-MPO, UHD Shelf 6PK Kit



SYSTIMAX 360™ iPatch® Fiber Shelves & Modules

MATERIAL ID	PRODUCT NUMBER	DESCRIPTION
760093336	360-iP-HD-2U-IP-SD	360 iPatch G2 HD Fiber Shelf, Slide
760093344	360-iP-HD-MOD-LC-LS	360 iPatch G2 HD LS Module
760093351	360-iP-HD-MOD-LC-LS-3	360 iPatch G2 HD LS Module (3-pack)
760093369	360-iP-HD-MOD-LC-TS	360 iPatch G2 HD TS Module
760093377	360-iP-HD-MOD-LC-TS-3	360 iPatch G2 HD TS Module (3-pack)
760093385	360-iP-HD-MOD-LC-OS	360 iPatch G2 HD OS Module
760093393	360-iP-HD-MOD-LC-OS-3	360 iPatch G2 HD OS Module (3-pack)

iPatch® Panel and Cassette Module

MATERIAL ID	PRODUCT NUMBER	DESCRIPTION
760161000	360-iP-INSTA-QTR0-24P	360 iPatch InstaPATCH QUATTRO 1U Panel, 24 port
760159905	360-iP-UP-KIT-IPQ-24P	360 iPatch 1U Panel Upgrade Kit InstaPATCH QUATTRO, 24 port, 10 pack



Enterprise

Workstation Platforms & Accessories

Faceplates

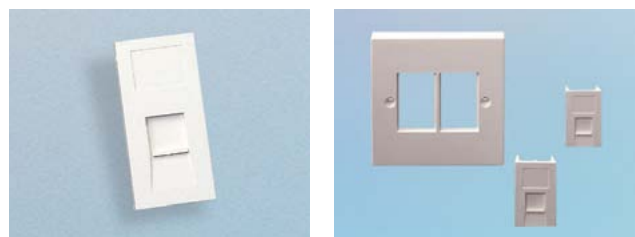

Modular Faceplates and Clips UK Applications

MATERIAL ID	DESCRIPTION	DEPTH	HEIGHT	WIDTH
Z60161067	LF80-262 Shuttered Faceplate Clip, 1-port, White	13.21 mm 0.52 in	38.35 mm 1.51 in	24.89 mm 0.98 in
Z60161109	LF80-003 Shuttered Faceplate Clip, 1-port, Black	13.21 mm 0.52 in	38.35 mm 1.51 in	24.89 mm 0.98 in
Z60161133	LF80-123 Shuttered Faceplate Clip, 1-port, Yellow	13.21 mm 0.52 in	38.35 mm 1.51 in	24.89 mm 0.98 in
Z60161117	LF80-318 Shuttered Faceplate Clip, 1-port, Blue	13.21 mm 0.52 in	38.35 mm 1.51 in	24.89 mm 0.98 in
Z60161125	LF80-226 Shuttered Faceplate Clip, 1-port, Green	13.21 mm 0.52 in	38.35 mm 1.51 in	24.89 mm 0.98 in
Z60161075	LF80-A-262 Angled Shuttered Faceplate Clip, 1-port, White	13.21 mm 0.52 in	38.35 mm 1.51 in	24.89 mm 0.98 in
Z60161224	LF00-262 Blank Faceplate Clip, 1-port, White	13.97 mm 0.55 in	37.85 mm 1.49 in	24.89 mm 0.98 in
Z60187880	4 Gang UK Faceplate-262 (White)	8.89 mm 0.35 in	86.11 mm 3.39 in	146.05 mm 5.75 in
Z60187872	2 Gang UK Faceplate-262 (White)	8.89 mm 0.35 in	85.85 mm 3.38 in	85.85 mm 3.38 in
Z60189480	M14D BACK BOX 45-262 (White)	44.96 mm 1.77 in	85.85 mm 3.38 in	145.80 mm 5.74 in
Z60189472	M12D BACK BOX 37-262 (White)	36.83 mm 1.45 in	85.85 mm 3.38 in	85.85 mm 3.38 in
Z60189464	M12D BACK BOX 45-262 (White)	44.96 mm 1.77 in	85.85 mm 3.38 in	85.85 mm 3.38 in



Modular Faceplates and Clips UK German/Benelux Applications

MATERIAL ID	PPRODUCT NUMBER	DESCRIPTION
106720212	M02714-246	Coverplate 8.0 x 8.0 x 0.55 cm Flush, Ivory
Z60123877	M18930-246	Surface Mount Modular Faceplate, Ivory
Z60123885	M18932-246	Flush Mount Modular Faceplate, 2 port, Ivory
107052359	M02714-262	M18932-262 Coverplate 8.0 x 8.0 x 0.55 cm Flush, White
Z60123901	M18930-262	Duplex 8.0 x 6.5 x 3.5 cm Surface, White
Z60123893	M18932-262	Duplex 5.0 x 5.0 x 0.55 cm Flush, White
760085993	M12GER-FTP-262	Faceplate, German 2-port (F/UTP) 8.1 x 8.1 x 2.41 cm Surface, White
106837222	M81-246	M81-246 BLANK 1 .8 x 1.3 cm, Ivory
106837230	M81-262	M81-262 BLANK 1 .8 x 1.3 cm, White
760085993	M12GER-FTP	M12GER-FTP 2-Port German Faceplate

Faceplates

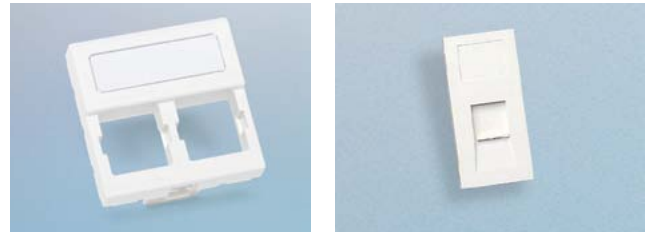

Modular Faceplates and Clips UK Applications

MATERIAL ID	DESCRIPTION	DEPTH	HEIGHT	WIDTH
760188250	LF81 BLACK-003	13.21 mm 0.52 in	50.04 mm 1.97 in	24.89 mm 0.98 in
760188243	LF81 WHITE-262	13.21 mm 0.52 in	50.04 mm 1.97 in	24.89 mm 0.98 in
760188268	LF81 IVORY-246	13.21 mm 0.52 in	50.04 mm 1.97 in	24.89 mm 0.98 in
760131417	LF81 MODULE BLANK-003, Black	13.97 mm 0.55 in	24.89 mm 0.98 in	49.78 mm 1.96 in
760189498	LF81 MODULE BLANK-262, White	13.97 mm 0.55 in	24.89 mm 0.98 in	49.78 mm 1.96 in
760193037	LF81A-262 Shuttered, White	13.97 mm 0.55 in	24.89 mm 0.98 in	49.78 mm 1.96 in
760172635	LF82-003 Shutt. Faceplate Clip, 1-port, Black	17.02 mm 0.67 in	45.21 mm 1.78 in	22.61 mm 0.89 in
760189506	LF82-262 Shutt Faceplate Clip, 1-port, White	17.02 mm 0.67 in	45.21 mm 1.78 in	22.61 mm 0.89 in



Enterprise

Racks, Shelves and Panels



2 Post Racks

MATERIAL ID	PRODUCT NUMBER	DESCRIPTION
760082479	RK3-45A	Rack, 19" RK3-45A (12-24)
760082487	RK3-52A	Rack, 19" RK3-52A (12-24)
760082495	RK6-45A	Rack, 19" RK6-45A (12-24)
760082503	RK6-52A	Rack, 19" RK6-52A (12-24)
760090118	RK3-45S	Rack, 19" RK3-45S (Sq Punched)
760090126	RK3-52S	Rack, 19" RK3-52S (Sq Punched)
760090134	RK6-45S	Rack, 19" RK6-45S (Sq Punched)
760090142	RK6-52S	Rack, 19" RK6-52S (Sq Punched)
760082511	RK12-45A	Rack, 19" RK12-45A (12-24)
760103010	RK3-17A	Rack, 19 Alum, 3 x 3ft (12-24) RK3-17A

Shelves - 2 Post Racks

MATERIAL ID	PRODUCT NUMBER	DESCRIPTION
760084178	SL50SS	Shelf, 19" SL50SS (19" deep)
760084186	SL375DS	Shelf, 19" SL375DS (19" deep)
760084194	SL3200DS	Shelf, 19" SL3200DS (19" deep)



4 Post Racks

MATERIAL ID	PRODUCT NUMBER	DESCRIPTION
760082529	RK4P45-29A	Rack, 19" RK4P45-29A (12-24)
760082537	RK4P52-29A	Rack, 19" RK4P52-29A (12-24)
760082545	RK4P45-29S	Rack, 19" RK4P45-29S is square punch
760082552	RK4P52-29S	Rack, 19" RK4P52-29S
760082560	RK4P45-36A	Rack, 19" RK4P45-36A (12-24)
760082578	RK4P52-36A	Rack, 19" RK4P52-36A (12-24)
760082586	RK4P45-36S	Rack, 19" RK4P45-36S
760082594	RK4P52-36S	Rack, 19" RK4P52-36S



Horizontal Cable Management

MATERIAL ID	PRODUCT NUMBER	DESCRIPTION
760072942	HTK-19-SS-1U	1U 19" Single Sided Horizontal Trough Kit
760072959	HTK-19-SS-2U	2U 19" Single Sided Horizontal Trough Kit
760072967	HTK-19-SS-3U	3U 19" Single Sided Horizontal Trough Kit

EMEA Patch Cord Organizers

MATERIAL ID	DESCRIPTION
760038240	1U Patchcord Management
760038257	2U Patchcord Management



Vertical Cable Management

MATERIAL ID	PRODUCT NUMBER	DESCRIPTION
760089342	VCM-DS-84-6B	Double Sided 6 X 84 VCM, black doors
760089359	VCM-DS-84-8B	Double Sided 8 X 84 VCM, black doors
760089367	VCM-DS-84-10B	Double Sided 10 X 84 VCM, black doors
760089375	VCM-DS-84-12B	Double Sided 12 X 84 VCM, black doors
760089425	VCM-SS-84-6B	Single Sided 6 X 84 VCM, black doors
760089433	VCM-SS-84-8B	Single Sided 8 X 84 VCM, black doors
760089441	VCM-SS-84-10B	Single Sided 10 X 84 VCM, black doors
760089458	VCM-SS-84-12B	Single Sided 12 X 84 VCM, black doors
760072785	VCM-DS-84-6	Double Sided 6 X 84 VCM, silver doors
760072793	VCM-DS-84-8	Double Sided 8 X 84 VCM, silver doors
760072801	VCM-DS-84-10	Double Sided 10 X 84 VCM, silver doors
760072819	VCM-DS-84-12	Double Sided 12 X 84 VCM, silver doors
760072868	VCM-SS-84-6	Single Sided 6 X 84 VCM, silver doors
760072876	VCM-SS-84-8	Single Sided 8 X 84 VCM, silver doors
760072884	VCM-SS-84-10	Single Sided 10 X 84 VCM, silver doors
760072892	VCM-SS-84-12	Single Sided 12 X 84 VCM, silver doors

CommScope, (NASDAQ: COMM)

helps companies around the world design, build and manage their wired and wireless networks. Our network infrastructure solutions help customers increase bandwidth; maximize existing capacity; improve network performance and availability; increase energy efficiency; and simplify technology migration. You will find our solutions in the largest buildings, venues and outdoor spaces; in data centers and buildings of all shapes, sizes and complexity; at wireless cell sites and in cable headends; and in airports, trains, and tunnels. Vital networks around the world run on CommScope solutions.



CommScope Certified Report Systems

WebTrak® gives you on-line factory test reports for Fiber, Hybrid Fiber, Twisted Pair Cables, Cable Assemblies and Base Station Antennas.

cTrak is our latest FREE mobile app to access factory tests on the go from your iPhone or iPad. Available on iTunes.



On-line Self Paced Training Courses

Available on our website through the CommScope Infrastructure Academy.
