

15 m (50 ft) ULM Mast

Overview

- Fully deployed heights of 10, 15, 17 & 20 m (32, 49, 56 & 65 ft).
- The ULM-G 92 is a lightweight glass composite sleeve mast capable of supporting headloads up to 40kg (88 lbs) ¹
- The mast comprises individual composite mast tube sections that fit together to give the desired height.
- The mast sections are RF invisible so omni-directional antennas can be mounted at any height using an optional mounting bracket
- The tripod support includes a lifting mechanism and hoist to raise each section.
- Telescopic tripod legs allow deployment on uneven ground.
- Tripod kneeling position for easy access to the top load.
- Central guying enables the guy tension to be maintained during erection of the mast. This enables the mast to be deployed safely in high winds.
- The mast is supplied with a ground mounting kit containing all the items required for field deployment.
- Particularly suited to supporting line-of-sight (LOS) antennas. Also suitable for supporting directional, omni-directional or wire antennas, optronic equipment and sensors.
- Azimuth rotation is possible from the ground to orientate directional top loads.
- Can be deployed by two operators in 20 minutes or three operators in 15 minutes (15m/49ft model)
- full compliancy with ANSI TIA/EIA-222-F wind standard.



Complete mast kit packs into two man-portable bags

Mechanical Specification

Model	ULM-G 92/10-1.5	ULM-G 92/15-1.5	ULM-G 92/17-1.5	ULM-G 92/20-1.5
Height	10m (32 ft)	15m (49 ft)	17m (56 ft)	20m (65 ft)
Tube diameter	92mm (3.62 ins)			
Mast section working length	1264.5mm (4 ft 2 ins)			
Maximum Headload ¹	40kg (88 lbs) , 1m ² (10 ft ²)	30kg (66 lbs) , 1m ² (10 ft ²)	30kg (66 lbs) , 1m ² (10 ft ²)	20kg (44 lbs) , 0.5m ² (5 ft ²)
Maximum wind speed: Deployment Operation Survival	40km/h (25 mph) 90km/h (56 mph) 120km/h (93 mph)			
Maximum bending deflection under operational wind	<±4°	<±4°	<±4°	<±5°
Total kit weight	85 kg (187 lbs)	95 kg (209 lbs)	102 kg (224 lbs)	110 kg (242 lbs)
Guy Radius	8 m (26 ft)	10 m (32 ft)	12 m (39 ft)	14 m (46 ft)
Top load interfaces available	40mm (1.57 in) spigot 50mm (1.97 in) spigot Vee Ring Adaptor			
Temperature range	-40°C (-40 °F) to +55°C (131 °F)			
Anchoring	3 locations at 120°	3 locations at 120°	3 locations at 120°	3 locations at 120°
Guying	Single level - Kevlar rope	Lower level - Kevlar Rope Upper level - Kevlar rope	Lower level - Kevlar Rope Upper levels - Kevlar rope	Lower level - Kevlar Rope Upper levels - Kevlar rope
Standard colour	IR-NATO 24x5 Army Green Other colours available on request			
Number of operators	2 or 3	2 or 3	2 or 3	2 or 3
Set-up time (approx.)	10 mins (3 operators) 15 mins (2 operators)	15 mins (3 operators) 20 mins (2 operators)	20 mins (3 operators) 25 mins (2 operators)	25 mins (3 operators) 30 mins (2 operators)

¹ Maximum headload weight subject to wind surface area

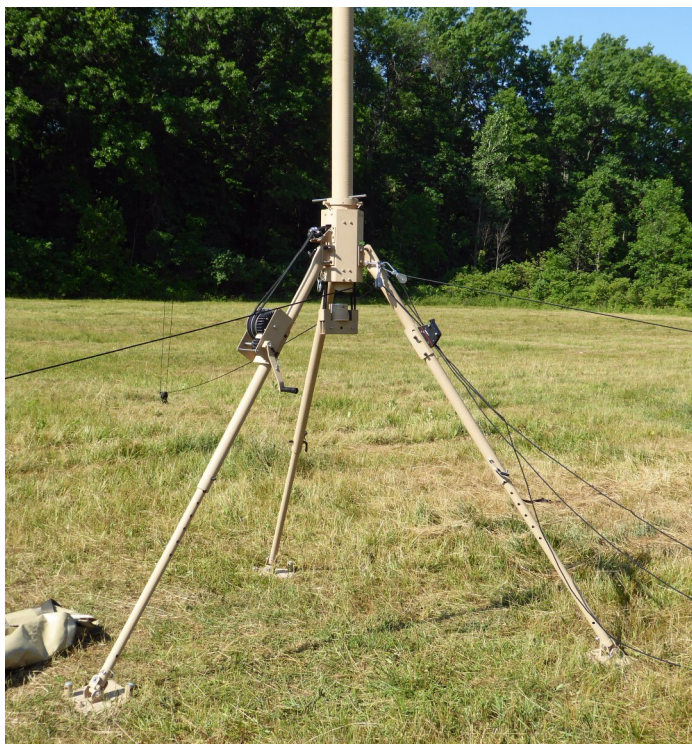

Tripod assembly
(shown with optional winch assembly)



Multiple headload
mounting options

Typical Kit Contents (15m/49ft model)



Bag 1



Bag 2

Qty : (2) Transportation bag
(1500x370x290)
Uw : 5.6kg (12.34lbs)

Description (Bag 1)	Qty
Mast section	10
Mast section with 50mm spigot	1
Transportation bag	1

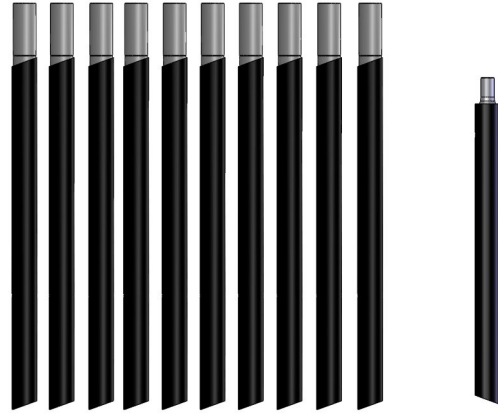

Qty : (10) ULM Mast section
Uw : 2.61kg (5.75lbs)

Qty : (1) Top section Ø50mm
Uw : 3kg (6.61lbs)

Description (Bag 2)	Qty
Tripod assembly with lifting system	1
Guy stakes 60 cm	6
Lower guy cable	3
Guying collar	2
Anchor stakes	6
Cross pin	2
Hammer 3kg	1
Cable strap	4
Radius rope	1
Safety cable for kneeling position	2
Transportation bag	1



Qty : (1) Composite Tripod Assembly
(shown with optional winch)
Uw : 30kg (66lbs)

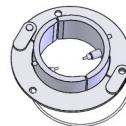

Qty : (2) Guying collar
Uw : 0.97kg (2.15lbs)



Qty : (1) Radius Rope 10m (32ft)
Uw : 0.8kg (1.76lbs)



Qty : (3) Lower guy cable
Uw : 0.8kg (1.76lbs)

Top load interface (top of mast)

The top of the mast can be supplied with a 40mm or 50mm spigot or V-ring collar. The V-ring collar can be adapted to suit many different headloads. The V-ring provides reliable, strong and tactical fixation of many available adapters.

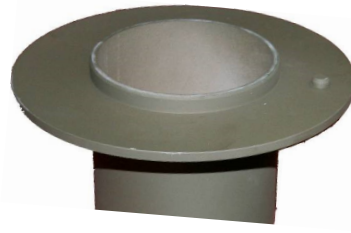

V-ring flange on top of mast

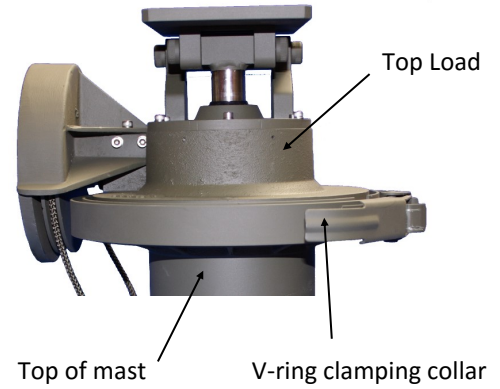

Top of mast

V-ring clamping collar

Optional Accessories

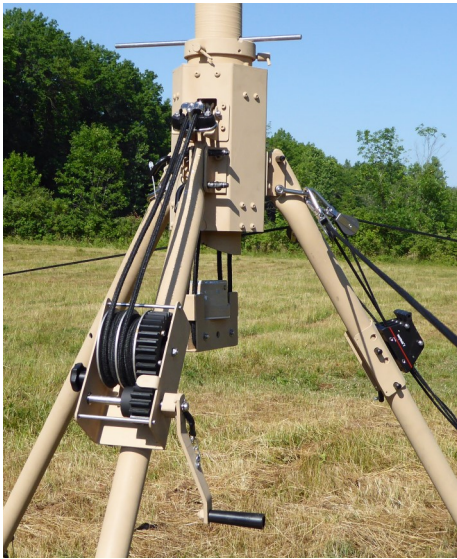

Winch Assembly

An optional winch assembly allows heavier top loads to be deployed with reduced effort.

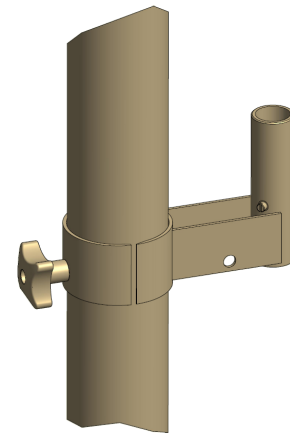

Bracket for lower antenna

A lower bracket is available with a 40mm or 50mm spigot. It is designed to fix a lower antenna on a ULM mast section.

Manual Tilters and Rotator

Manual rotators and tilters allow orientation of the antenna in azimuth over 360° and elevation over $\pm 15^\circ$. The Comrod range of rotators and tilters are particularly designed for tactical line of sight (LOS) antenna systems.

All rotators and tilters are operated from the ground using ropes.



Manual Tilter



Manual Rotator