

塑封超快速整流二极管  
反向电压 600V  
正向电流 20A

Plastic Ultra-Fast Recover Rectifier  
Reverse Voltage 600 V  
Forward Current 20 A

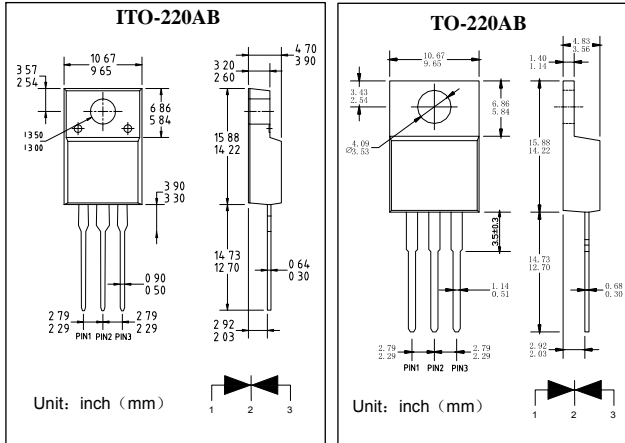

### 特征 Features

- 大电流承受能力。High Current Capability
- 正向压降低。Low Forward Voltage Drop
- 低功耗高效率。Low Power Loss, High Efficiency
- 引线 and 管体皆符合RoHS标准。  
Lead and body according with RoHS standard

### 机械数据 Mechanical Data

- 封装: 塑料封装 Case: Molded Plastic
- 极性: 标记模压或印于本体  
Polarity: Symbols molded or marked on body
- 安装位置: 任意 Mounting Position: Any
- 安装扭矩: 推荐值 0.3牛\*米 Mounting torque: Recommend 0.3 N\*m

极限值和温度特性 TA = 25℃ 除非另有规定。

Maximum Ratings & Thermal Characteristics Ratings at 25℃ ambient temperature unless otherwise specified.

	符号 Symbols	DUFF20A60CT(ITO-220AB) DUF20A60CT(TO-220AB)	单位 Unit
最大可重复峰值反向电压 Maximum repetitive peak reverse voltage	$V_{RRM}$	600	V
最大均方根电压 Maximum RMS voltage	$V_{RMS}$	420	V
最大直流阻断电压 Maximum DC blocking voltage	$V_{DC}$	600	V
最大正向平均整流电流 Maximum average forward rectified current	$I_{F(AV)}$	20	A
峰值正向浪涌电流 8.3ms单一正弦半波 Peak forward surge current 8.3 ms single half sine-wave	$I_{FSM}$	125	A
典型热阻 Typical thermal resistance	$R_{\theta JC}$	4.0	℃/W
工作结温和存储温度 Operating junction and storage temperature range	$T_j, T_{STG}$	-55---+150	℃

电特性 TA = 25℃ 除非另有规定。

Electrical Characteristics Ratings at 25℃ ambient temperature unless otherwise specified.

	符号 Symbols	DUFF20A60CT(ITO-220AB) DUF20A60CT(TO-220AB)	单位 Unit
最大正向电压 Maximum forward voltage	$I_F = 10A$ $V_F$	2.4	V
最大反向电流 Maximum reverse current	$T_A = 25^\circ C$ $T_A = 125^\circ C$ $I_R$	10 300	μA
最大反向恢复时间 MAX. Reverse Recovery Time	$I_F = 0.5A$ $I_R = 1.0A$ $I_{REC} = 0.25A$ $t_{rr}$	30	nS

特性曲线 Characteristic Curves

