

### SCHEMATIC

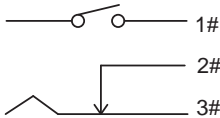

OPEN CIRCUIT

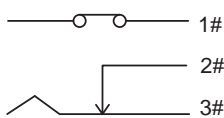

CLOSED CIRCUIT

### SPECIFICATION

**RATING :** DC 15V 2A ; DC 16V 3A

**CONTACT RESISTANCE :** 30 mΩ MAX.

**INSULATION RESISTANCE :** 100 MΩ MIN.

**MECHANICAL LIFE :** 30,000 cycles.

### MATERIALS

**CASE&HOUSING:** Glass filled Nylon 6/6,black.

**ACTUATOR :** Glass filled Nylon 6/6,gray.

**CONTACT :** Copper alloy,silver plated.

**TERMINALS :** Copper alloy,silver plated.

**PIN :** Brass,nickel plated.



### MODEL OPTIONS



SPST

Dimensions	PIN Ø A	Ø B
MODEL		
SJ-003	ø2.00	ø5.60
SJ-006	ø2.50	ø5.60

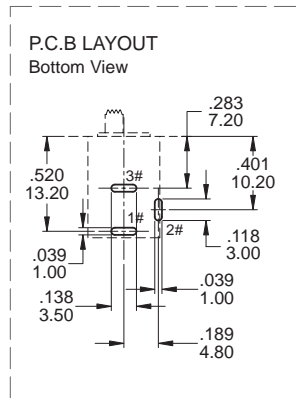
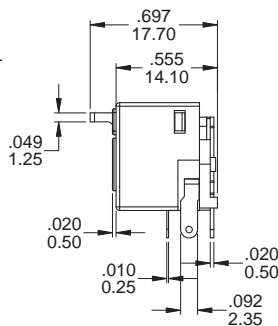
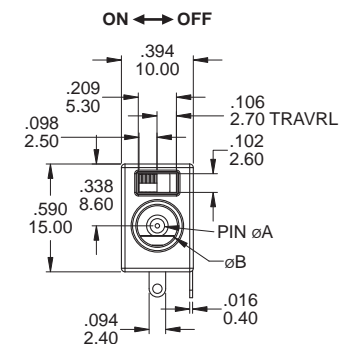

SPST

Part No. Shown : SJ-007

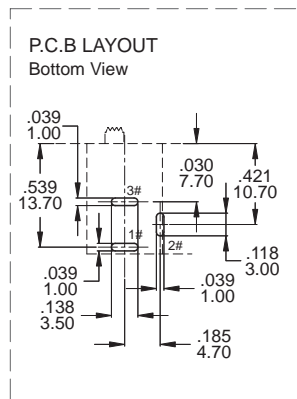
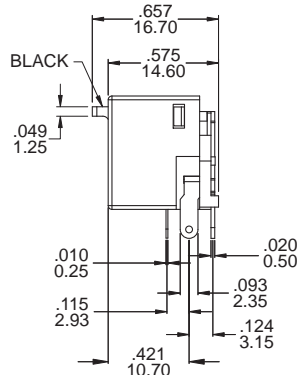
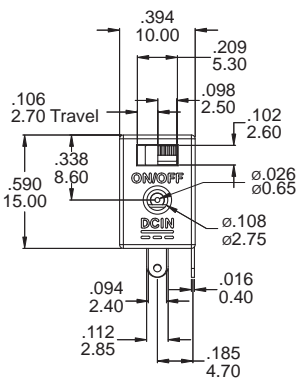

SPST

Dimensions	PIN Ø A	Ø B
MODEL		
SJ-004	ø2.00	ø6.30
SJ-005	ø2.50	ø6.50

