

SPECIFICATIONS

- CONTACT RESISTANCE:** 50mΩmax. initial .
- MECHANICAL LIFE:** 20,000 cycles.
- INSULATION RESISTANCE:** 1,000 MΩ min.
- DIELECTRIC STRENGTH:** 1,000 Vrms min. @sea level.
- OPERATING TEMPERATURE:** -40°C to 80°C.

MATERIALS

- CASE:** PBT,white.
- ACTUATOR:** PBT,black .
- HOUSING:** POM,black .
- CONTACT/TERMINALS:** Copper alloy,with silver or gold plated .
(See Page 95)



HOW TO ORDER

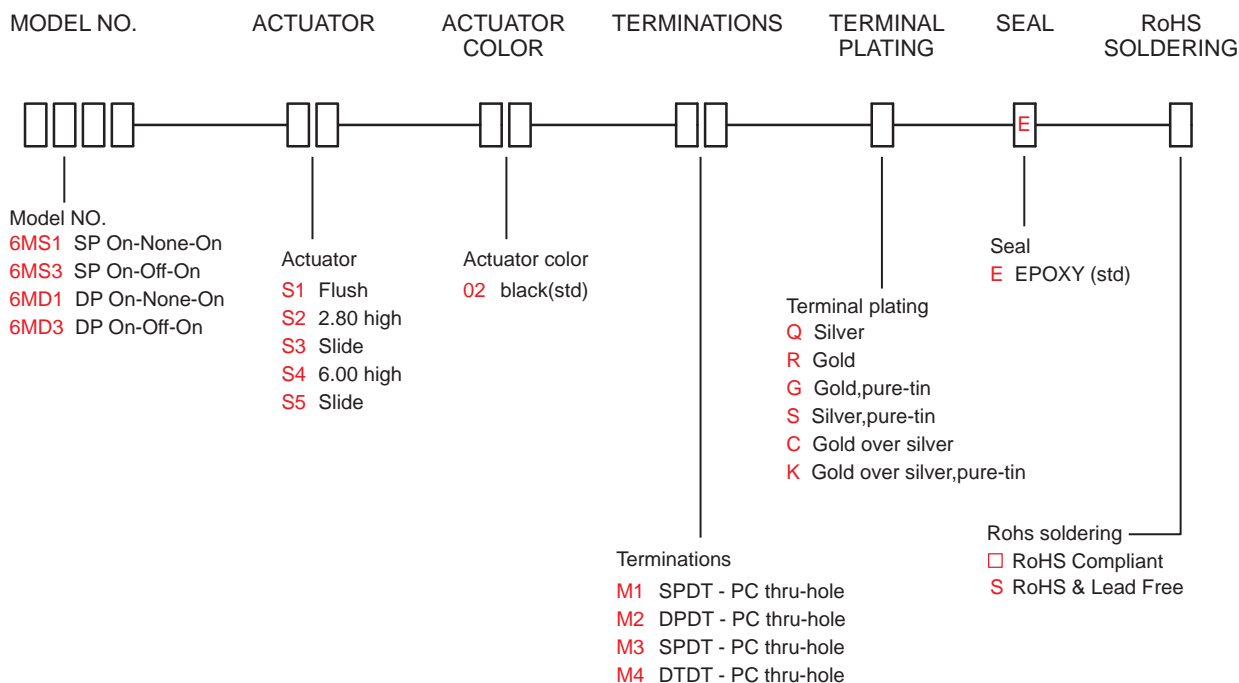

6M Series

Miniature Slide Switches for P.C. Board

SWITCH FUNCTION

NO. POLES	MODEL NO.	SWITCH FUNCTION			CONNECTED TERMINALS / SCHEMATIC		
		POS.1	POS.2	POS.3	POS.1	POS.2	POS.3
SP	6MS1	ON	NONE	ON	2-1 	OPEN	2-3
	6MS3	ON	OFF	ON			
DP	6MD1	ON	NONE	ON	2-1,5-4 	OPEN	2-3,5-6
	6MD3	ON	OFF	ON			

POLE OPTIONS



SPDT

Part No. Shown : 6MS1S202M1QE

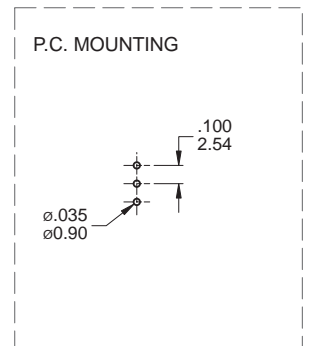
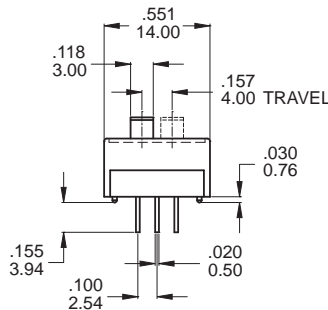
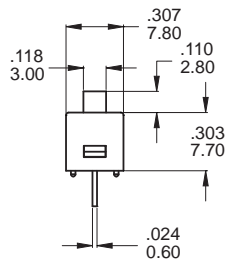

DPDT

Part No. Shown : 6MD1S202M2QE

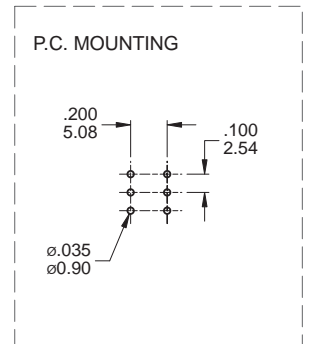
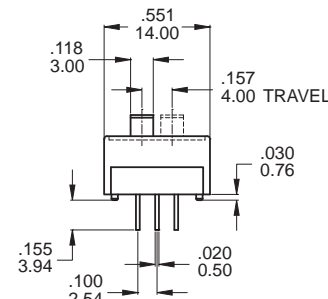
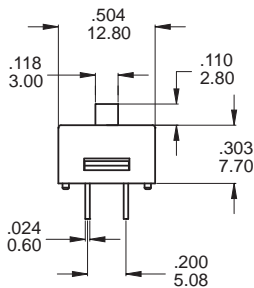

ACTUATOR OPTIONS

S1

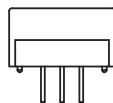

S2

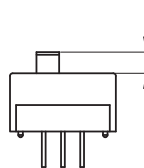
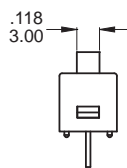

S5 Only DPDT

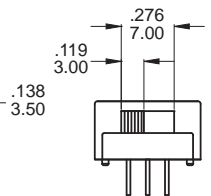
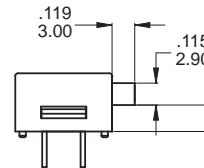

S3

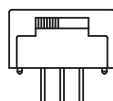
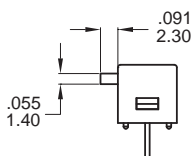

S4

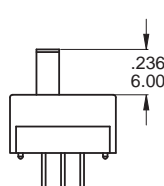
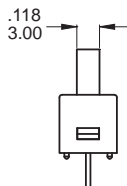

S6

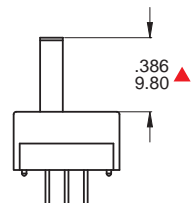
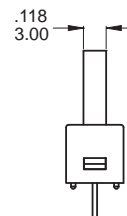

TERMINAL OPTIONS

M1

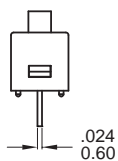

SPDT

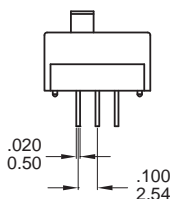

M2

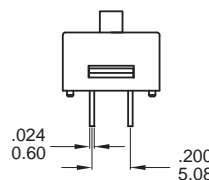

DPDT

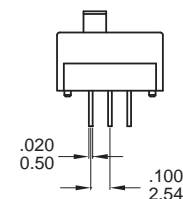

M3

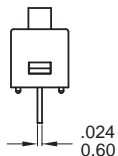

SPDT

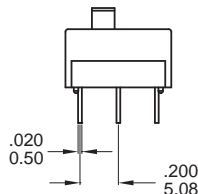

M4

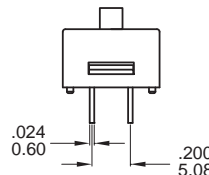

DPDT

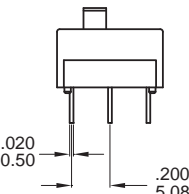

P.C.B MOUNTING

M1

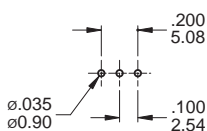

SPDT

M2

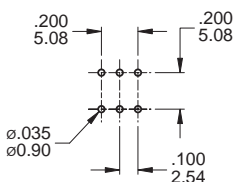

DPDT

M3

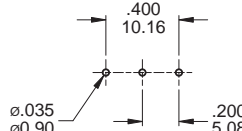

SPDT

M4

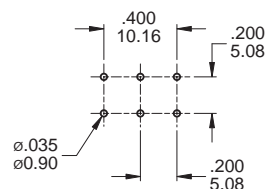

DPDT

CONTACT MATERIAL OPTIONS

	CONTACT PLATING	TERMINAL PLATING	RATINGS
Q	Silver	Q = Silver	3 Amps with resistant load @ 120VAC or 28VDC 1 Amps with resistant load @ 250VAC
S		S = Silver,pure - tin	
C	Gold over Silver	C = Gold over silver	
K		K = Gold over silver,pure - tin	
R	Gold	R = Gold	0.4 Volt - Amps (VA) max. @ 20V max. (AC or DC)
G		G = Gold,pure - tin	

SOLDERING PROCESSES

WAVE SOLDERING: Recommended Soldering Temperature: 260 ± 5°C

Duration of Solder Immersion: Max 5 sec. (PCB is 1.6mm in thickness)

