

1

2

3

4

A

A

B

B

C

C

D

D

REVISIONS				
ZONE	REV	DESCRIPTION	DATE	APPROVED

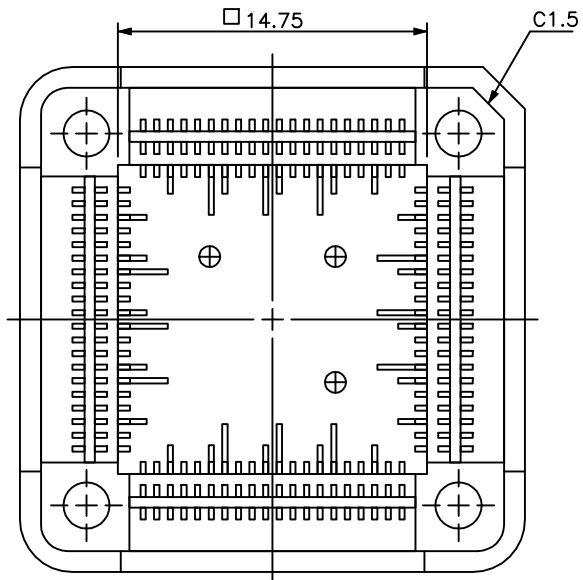
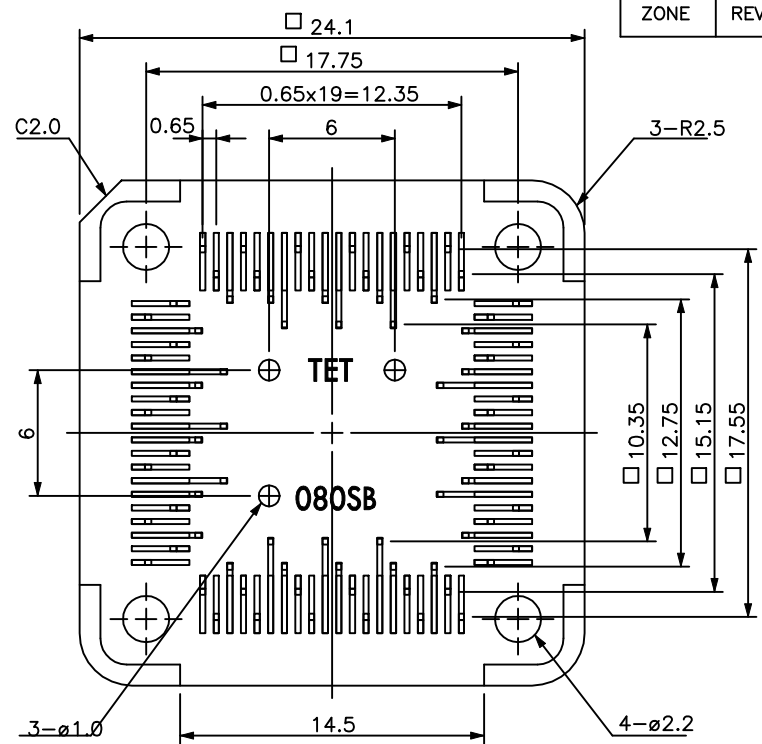

BOTTOM VIEW

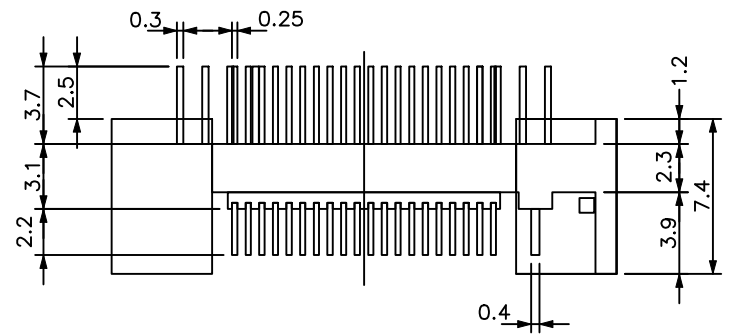

IC package	Square
Pin count	80Pin
Lead pitch	0.65mm

DRAWING NOT TO SCALE

ALL DIMENSIONS ARE IN MILLIMETERS



www.adapters.com

TEL:(408)855-8527
FAX:(408)855-8528

3024 Scott Blvd.
Santa Clara, CA 95054

adapters.com

An Embedded Systems Solutions Company

DESCRIPTION:
BASE-YQ-080Q65-EM-CVR

SIZE: **A**

DATE: 12-11-01

SCALE: 1:1

PART NO. **000-2179-00**

CHECKED: **Gabor Kardos**

DRAWN BY: **S. Barcellos**

REV

SHEET

1

2

3

4

Recommended a PWB layout of TQSOCKET/YQSOCKET080SB Series

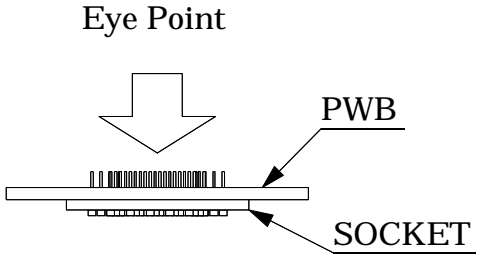
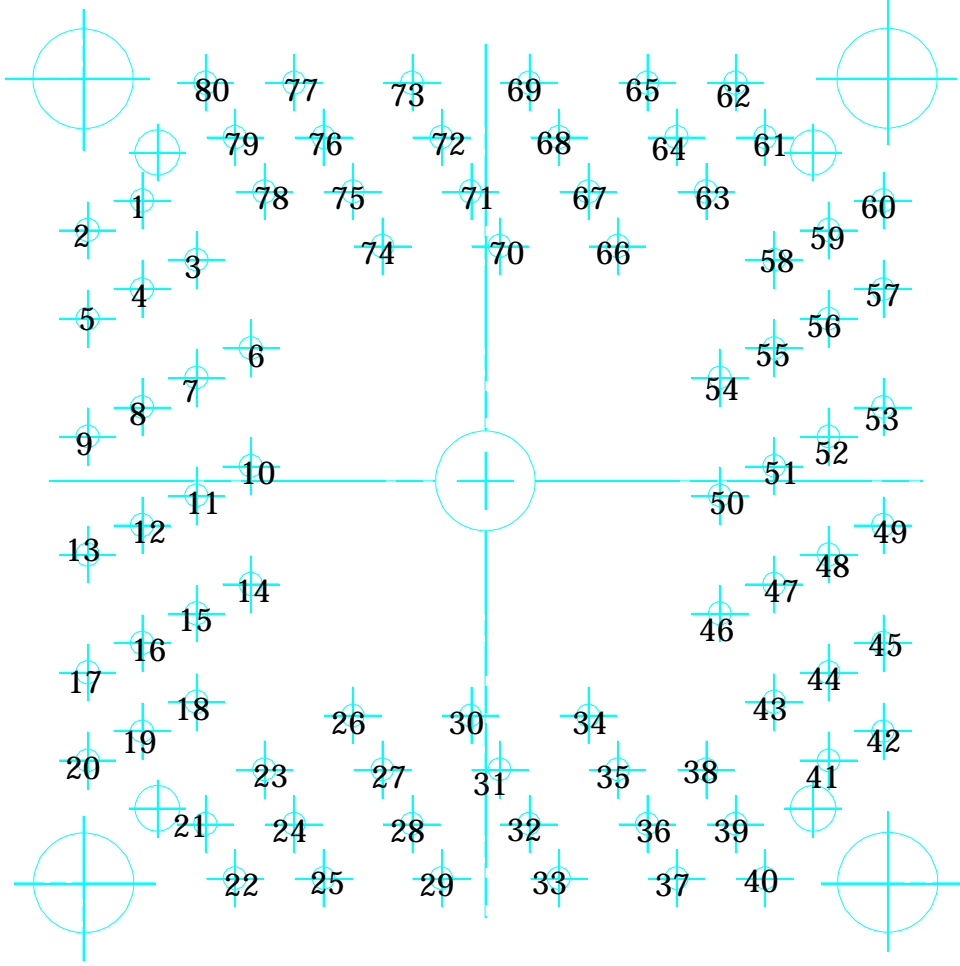

Part No.	TQ/YQSOCKET080SB	
IC package	Square	
Pin count	80	
Unit : mm	Design : M.H	
TET TOKYO ELETECH CORP.		

Recommended a PWB layout of TQSOCKET/YQSOCKET080SB Series

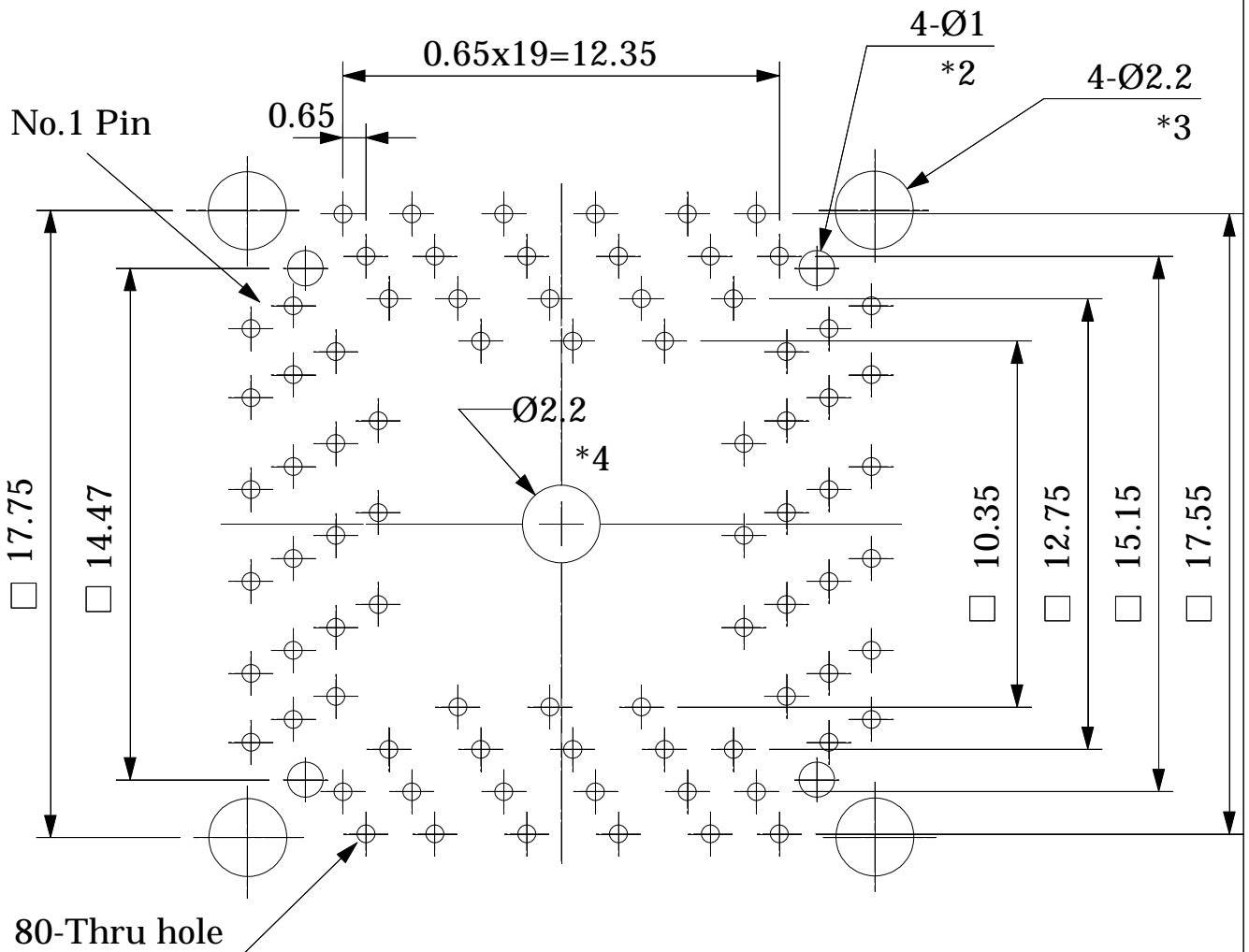

*1

NOTES:

*1 \oplus mark is through hole.

The diameter is 0.5mm after plating copper on the hole.

*2 TQSOCKET guide pin hole and location.

*3 YQSOCKET guide pin hole and location.

*4 Screw hole and location for fastening TQSOCKET.

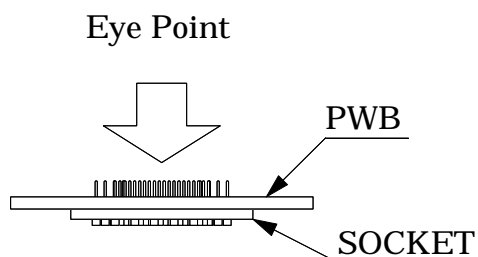

Part No.	TQ/YQ080SB	
IC package	Square	
Pin count	80Pin	
Lead pitch	0.65mm	
Unit : mm	Design : M.H	
TET TOKYO ELETECH CORP.		