



European technical approval ETA-10/0305

English translation prepared by DIBt - Original version in German language

Handelsbezeichnung <i>Trade name</i>	EJOT SDF 10V und EJOT SDF 10H <i>EJOT SDF 10V and EJOT SDF 10H</i>
Zulassungsinhaber <i>Holder of approval</i>	EJOT Baubefestigungen GmbH In der Stockwiese 35 57334 Bad Laasphe DEUTSCHLAND
Zulassungsgegenstand und Verwendungszweck <i>Generic type and use of construction product</i>	Kunststoffdübel als Mehrfachbefestigung von nichttragenden Systemen zur Verankerung im Beton und Mauerwerk <i>Plastic anchor for multiple use in concrete and masonry for non- structural applications</i>
Geltungsdauer: <i>Validity:</i>	vom <i>from</i> bis <i>to</i> 30 June 2013 30 June 2018
Herstellwerk <i>Manufacturing plant</i>	EJOT Herstellwerk 1, 2, 3 und 4

Diese Zulassung umfasst
This Approval contains

23 Seiten einschließlich 12 Anhänge
23 pages including 12 annexes

Diese Zulassung ersetzt
This Approval replaces

ETA-10/0305 mit Geltungsdauer vom 04.11.2011 bis 16.09.2015
ETA-10/0305 with validity from 04.11.2011 to 16.09.2015

I LEGAL BASES AND GENERAL CONDITIONS

- 1 This European technical approval is issued by Deutsches Institut für Bautechnik in accordance with:
 - Council Directive 89/106/EEC of 21 December 1988 on the approximation of laws, regulations and administrative provisions of Member States relating to construction products¹, modified by Council Directive 93/68/EEC² and Regulation (EC) N° 1882/2003 of the European Parliament and of the Council³;
 - *Gesetz über das In-Verkehr-Bringen von und den freien Warenverkehr mit Bauprodukten zur Umsetzung der Richtlinie 89/106/EWG des Rates vom 21. Dezember 1988 zur Angleichung der Rechts- und Verwaltungsvorschriften der Mitgliedstaaten über Bauprodukte und anderer Rechtsakte der Europäischen Gemeinschaften (Bauproduktengesetz - BauPG) vom 28. April 1998⁴, as amended by Article 2 of the law of 8 November 2011⁵;*
 - Common Procedural Rules for Requesting, Preparing and the Granting of European technical approvals set out in the Annex to Commission Decision 94/23/EC⁶;
 - Guideline for European technical approval of "Plastic Anchors for Multiple Use in Concrete and Masonry for Non-structural Applications - Part 1: General", ETAG 020-01.
- 2 Deutsches Institut für Bautechnik is authorized to check whether the provisions of this European technical approval are met. Checking may take place in the manufacturing plant. Nevertheless, the responsibility for the conformity of the products to the European technical approval and for their fitness for the intended use remains with the holder of the European technical approval.
- 3 This European technical approval is not to be transferred to manufacturers or agents of manufacturers other than those indicated on page 1, or manufacturing plants other than those indicated on page 1 of this European technical approval.
- 4 This European technical approval may be withdrawn by Deutsches Institut für Bautechnik, in particular pursuant to information by the Commission according to Article 5(1) of Council Directive 89/106/EEC.
- 5 Reproduction of this European technical approval including transmission by electronic means shall be in full. However, partial reproduction can be made with the written consent of Deutsches Institut für Bautechnik. In this case partial reproduction has to be designated as such. Texts and drawings of advertising brochures shall not contradict or misuse the European technical approval.
- 6 The European technical approval is issued by the approval body in its official language. This version corresponds fully to the version circulated within EOTA. Translations into other languages have to be designated as such.

¹ Official Journal of the European Communities L 40, 11 February 1989, p. 12
² Official Journal of the European Communities L 220, 30 August 1993, p. 1
³ Official Journal of the European Union L 284, 31 October 2003, p. 25
⁴ *Bundesgesetzblatt Teil I 1998*, p. 812
⁵ *Bundesgesetzblatt Teil I 2011*, p. 2178
⁶ Official Journal of the European Communities L 17, 20 January 1994, p. 34

II SPECIFIC CONDITIONS OF THE EUROPEAN TECHNICAL APPROVAL

1 Definition of product and intended use

1.1 Definition of the construction product

The EJOT SDF 10V and EJOT SDF 10H is a plastic anchor consisting of a plastic sleeve made of polyamide and an accompanying specific screw of galvanised steel or of stainless steel.

The plastic sleeve is expanded by screwing in the specific screw which presses the sleeve against the wall of the drilled hole.

The installed anchor is shown in Annex 1.

1.2 Intended use

The anchor is intended to be used for anchorages for which requirements for safety in use in the sense of the Essential Requirement 4 of Council Directive 89/106/EEC shall be fulfilled and failure of the fixture represents an immediate risk to human life.

The anchor is to be used only for multiple fixing for non-structural applications.

The base material may consist of use category a, b and c as given in the following Table:

Use category	Anchor type	Remarks
a	EJOT SDF 10V EJOT SDF 10H	<ul style="list-style-type: none"> • Normal weight concrete • Strength class C12/15 at minimum and C50/60 at maximum according to EN 206-1:2000-12 • Cracked and non-cracked concrete • The anchor EJOT SDF 10V (with $h_{nom,2} \geq 50$ mm) and EJOT SDF 10H may also be used with requirements related to resistance to fire according 4.2.2.
	EJOT SDF 10H ($h_{nom} \geq 70$ mm)	<ul style="list-style-type: none"> • Thin skins (weather resistant skins of external wall panels) • $100 \text{ mm} > h \geq 50 \text{ mm}$ • Strength class C12/15 at minimum and C50/60 at maximum according to EN 206-1:2000-12
b	EJOT SDF 10V ($h_{nom,2} \geq 50$ mm) EJOT SDF 10H ($h_{nom} \geq 70$ mm)	<ul style="list-style-type: none"> • Masonry walls according to Annex 7 and 8 • Mortar strength class $\geq M 2,5$ according to EN 998-2:2003
c	EJOT SDF 10H ($h_{nom} = 70$ mm)	<ul style="list-style-type: none"> • Masonry walls according to Annex 9 • Mortar strength class $\geq M 2,5$ according to EN 998-2:2003

Specific screws of galvanised steel:

The specific screws made of galvanised steel may only be used in structures subject to dry internal conditions.

These screws with exception of the stair bolt according Annex 2 may also be used in structures subject to external atmospheric exposure, if the area of the head of the screw is protected against moisture and driving rain after mounting of the fixing unit in this way, that intrusion of moisture into the anchor shaft is prevented. Therefore there shall be an external cladding or a ventilated rainscreen mounted in front of the head of the screw and the head of the screw itself shall be coated with a soft plastic, permanently elastic bitumen-oil-combination coating (e. g. undercoating or body cavity protection for cars).

Specific screws of stainless steel:

The specific screw made of stainless steel may be used in structures subject to dry internal conditions and also in structures subject to external atmospheric exposure (including industrial and marine environment), or exposure in permanently damp internal conditions, if no particular aggressive conditions exist. Such particular aggressive conditions are e. g. permanent, alternating immersion in seawater or the splash zone of seawater, chloride atmosphere of indoor swimming pools or atmosphere with extreme chemical pollution (e. g. in desulphurization plants or road tunnels where de-icing materials are used).

The anchor may be used in the following temperature range:

Temperature range b):	-40 °C to +80 °C	(max long term temperature +50 °C and max short term temperature +80 °C)
Temperature range c):	-40 °C to +50 °C	(max long term temperature +30 °C and max short term temperature +50 °C)

The provisions made in this European technical approval are based on an assumed working life of the anchor of 50 years. The indications given on the working life cannot be interpreted as a guarantee given by the producer, but are to be regarded only as a means for choosing the right products in relation to the expected economically reasonable working life of the works.

2 Characteristics of the product and methods of verification

2.1 Characteristics of the product

The anchor corresponds to the drawings and information given in Annex 2 and 3. The characteristic material values, dimensions and tolerances of the anchor not given in these Annexes shall correspond to the respective values laid down in the technical documentation⁷ of this European technical approval.

The characteristic values for the design of the anchorages are given in Annex 4 to 10.

Each anchor is to be marked with the identifying mark, the type, the diameter and the length of the anchor according to Annex 2.

The minimum embedment depths shall be marked.

The anchor shall only be packaged and supplied as a complete unit.

In addition to the specific clauses relating to dangerous substances contained in this European technical approval, there may be other requirements applicable to the products falling within its scope (e. g. transposed European legislation and national laws, regulations and administrative provisions). In order to meet the provisions of the Construction Products Directive, these requirements need also to be complied with, when and where they apply.

⁷ The technical documentation of this European technical approval is deposited at the Deutsches Institut für Bautechnik and, as far as relevant for the tasks of the approved bodies involved in the attestation of conformity procedure, is handed over to the approved bodies.

2.2 Methods of verification

The assessment of the fitness of the anchor for the intended use in relation to the requirements for safety in use in the sense of the Essential Requirement 4 has been made in compliance with the Guideline for European technical approval of "Plastic Anchors for Multiple Use in Concrete and Masonry for Non-structural Applications", ETAG 020,

- Part 1: "General",
 - Part 2: "Plastic Anchors for Use in Normal Weight Concrete",
 - Part 3: "Plastic Anchors for Use in Solid Masonry Materials" and
 - Part 4: "Plastic Anchors for Use in Hollow or Perforated Masonry",
- based on the use categories a, b and c.

3 Evaluation and attestation of conformity and CE marking

3.1 System of attestation of conformity

According to the decision 97/463/EG of the European Commission⁸ the system 2(ii) (referred to as system 2+) of attestation of conformity applies.

This system of attestation of conformity is defined as follows.

System 2+: Declaration of conformity of the product by the manufacturer on the basis of:

- (a) Tasks for the manufacturer:
 - (1) initial type-testing of the product;
 - (2) factory production control;
 - (3) testing of samples taken at the factory in accordance with a prescribed control plan.
- (b) Tasks for the approved body:
 - (4) certification of factory production control on the basis of:
 - initial inspection of factory and of factory production control;
 - continuous surveillance, assessment and approval of factory production control.

3.2 Responsibilities

3.2.1 Tasks of the manufacturer

3.2.1.1 Factory production control

The manufacturer shall exercise permanent internal control of production. All the elements, requirements and provisions adopted by the manufacturer shall be documented in a systematic manner in the form of written policies and procedures, including records of results performed. This production control system shall insure that the product is in conformity with this European technical approval.

The manufacturer may only use raw materials stated in the technical documentation of this European technical approval.

The factory production control shall be in accordance with the control plan which is part of the technical documentation of this European technical approval. The control plan is laid down in the context of the factory production control system operated by the manufacturer and deposited at Deutsches Institut für Bautechnik.⁹

⁸ Official Journal of the European Communities L 198 of 25.07.1997.

⁹ The control plan is a confidential part of the documentation of the European technical approval, but not published together with the ETA and only handed over to the approved body involved in the procedure of attestation of conformity. See section 3.2.2.

The results of factory production control shall be recorded and evaluated in accordance with the provisions of the control plan.

3.2.1.2 Other tasks of manufacturer

The manufacturer shall, on the basis of a contract, involve a body which is approved for the tasks referred to in section 3.1 in the field of anchors in order to undertake the actions laid down in section 3.2.2. For this purpose, the control plan referred to in sections 3.2.1.1 and 3.2.2 shall be handed over by the manufacturer to the approved body involved.

The manufacturer shall make a declaration of conformity, stating that the construction product is in conformity with the provisions of this European technical approval.

3.2.2 Tasks of approved bodies

The approved body shall perform the

- initial inspection of factory and of factory production control,
 - continuous surveillance, assessment and approval of factory production control,
- in accordance with the provisions laid down in the control plan.

The approved body shall retain the essential points of its actions referred to above and state the results obtained and conclusions drawn in a written report.

The approved certification body involved by the manufacturer shall issue an EC certificate of conformity of the factory production control stating the conformity with the factory production control of this European technical approval.

In cases where the provisions of the European technical approval and its control plan are no longer fulfilled the certification body shall withdraw the certificate of conformity and inform Deutsches Institut für Bautechnik without delay.

3.3 CE marking

The CE marking shall be affixed on each packaging of the anchor. The letters "CE" shall be followed by the identification number of the approved certification body, where relevant, and be accompanied by the following additional information:

- the name and address of the producer (legal entity responsible for the manufacturer),
- the last two digits of the year in which the CE marking was affixed,
- the number of the EC certificate for the factory production control,
- the number of the European technical approval,
- the number of the guideline for European technical approval,
- use category a, b and c.

4 Assumptions under which the fitness of the product for the intended use was favourably assessed

4.1 Manufacturing

The European technical approval is issued for the product on the basis of agreed data/information, deposited with Deutsches Institut für Bautechnik, which identifies the product that has been assessed and judged. Changes to the product or production process, which could result in this deposited data/information being incorrect, should be notified to Deutsches Institut für Bautechnik before the changes are introduced. Deutsches Institut für Bautechnik will decide whether or not such changes affect the ETA and consequently the validity of the CE marking on the basis of the ETA and if so whether further assessment or alterations to the ETA shall be necessary.

4.2 Design of anchorages

4.2.1 General

Fitness for the intended use of the anchor is given under the following conditions:

- The design of anchorages is carried out in compliance with ETAG 020, Guideline for European technical approval of "Plastic Anchors for Multiple Use in Concrete and Masonry for Non-structural Applications", Annex C under the responsibility of an engineer experienced in anchorages.
- Verifiable calculation notes and drawings shall be prepared taking account of the loads to be anchored, the nature and strength of the base materials and the dimensions of the anchorage members as well as of the relevant tolerances.
- The anchor is to be used only for multiple fixing for non-structural applications.

Therefore the design of the fixture may specify the number n_1 of fixing points to fasten the fixture and the number n_2 of anchors per fixing point. Furthermore the design value of actions N_{Sd} on a fixing point to a value $\leq n_3$ (kN) is specified up to which the strength and stiffness of the fixture are fulfilled and the load transfer in the case of excessive slip or failure of one anchor need not be taken into account in the design of the fixture.

The following default values for n_1 , n_2 and n_3 may be taken:

$$\begin{array}{l} n_1 \geq 4; \quad n_2 \geq 1 \quad \text{and} \quad n_3 \leq 4,5 \text{ kN} \quad \text{or} \\ n_1 \geq 3; \quad n_2 \geq 1 \quad \text{and} \quad n_3 \leq 3,0 \text{ kN}. \end{array}$$

- Shear loads acting on an anchor may be assumed to act without lever arm if both of the following conditions are fulfilled:
 - The fixture shall be made of metal and in the area of the anchorage be fixed directly to the base material either without an intermediate layer or with a levelling layer of mortar with a thickness ≤ 3 mm.
 - The fixture shall be in contact with the anchor over its entire thickness. (Therefore the diameter of clearance hole in the fixture d_f has to be equal or smaller than the value given in Annex 3, Table 3.)

If these two conditions are not fulfilled the lever arm is calculated according to ETAG 020, Annex C. The characteristic bending moment is given in Annex 4, Table 4.

4.2.2 Resistance in concrete (use category "a")

The characteristic values of resistance of the anchor for use in concrete are given in Annex 4, 5 and 6. The design method is valid for cracked and non-cracked concrete.

According to the Technical Report TR 020 "Evaluation of anchorages in concrete concerning resistance to fire" it can be assumed that for fastening of facade systems the load bearing behaviour of the EJOT SDF 10V with $h_{nom,2} \geq 50$ mm and EJOT SDF 10H has a sufficient resistance to fire at least 90 minutes (R90) if the admissible load $[F_{Rk} / (\gamma_M \cdot \gamma_F)]$ is $\leq 0,8$ kN (no permanent centric tension load).

4.2.3 Resistance in solid masonry (use category "b")

The characteristic values of resistance of the anchor for use in solid masonry are given in Annex 8 and 9. These values are independent of the load direction (tension, shear or combined tension and shear) and the mode of failure.

The characteristic resistances given in Annex 8 and 9 for use in solid masonry are only valid for the base material and the bricks according this table or larger brick sizes and larger compressive strength of the masonry unit.

If smaller brick sizes are present on the construction site or if the mortar strength is smaller than the required value, the characteristic resistance of the anchor may be determined by job site tests according to 4.4.

4.2.4 Resistance in hollow or perforated masonry (use category "c")

The characteristic resistances for use in hollow or perforated masonry given in Annex 10 are only valid for the bricks and blocks according this table regarding base material, size of the units, compressive strength and configuration of the voids.

These values are independent of the load direction (tension, shear or combined tension and shear) and the mode of failure and are valid for $h_{nom} = 70$ mm only.

The influence of larger embedment depths ($h_{nom} > 70$ mm) and/or different bricks and blocks (according Annex 10 regarding base material, size of the units, compressive strength and configuration of the voids) has to be detected by job site tests according to 4.4.

4.2.5 Specific conditions for the design method in solid masonry and hollow or perforated masonry

The mortar strength class of the masonry has to be M 2,5 according to EN 998-2:2003 at minimum.

The characteristic resistance F_{Rk} for a single plastic anchor may also be taken for a group of two or four plastic anchors with a spacing equal or larger than the minimum spacing s_{min} .

The distance between single plastic anchors or a group of anchors should be $a \geq 250$ mm.

If the vertical joints of the wall are designed not to be filled with mortar then the design resistance N_{Rd} has to be limited to 2,0 kN to ensure that a pull-out of one brick out of the wall will be prevented. This limitation can be omitted if interlocking units are used for the wall or when the joints are designed to be filled with mortar.

If the joints of the masonry are not visible the characteristic resistance F_{Rk} has to be reduced with the factor $\alpha_j = 0,5$.

If the joints of the masonry are visible (e.g. unplastered wall) following has to be taken into account:

- The characteristic resistance F_{Rk} may be used only, if the wall is designed such that the joints are to be filled with mortar.
- If the wall is designed such that the joints are not to be filled with mortar then the characteristic resistance F_{Rk} may be used only, if the minimum edge distance c_{min} to the vertical joints is observed. If this minimum edge distance c_{min} can not be observed then the characteristic resistance F_{Rk} has to be reduced with the factor $\alpha_j = 0,5$.

4.2.6 Characteristic values, spacing and dimensions of anchorage member

The minimum spacing and dimensions of anchorage member according to Annex 7 and Annex 11 shall be observed depending on the base material.

4.2.7 Displacement behaviour

The displacements under tension and shear loading in concrete and masonry are given in Annex 6, Table 8.

4.3 Installation of anchor

The fitness for use of the anchor can only be assumed if the following conditions of installation are met:

- Anchor installation carried out by appropriately qualified personnel under the supervision of the person responsible for technical matters on site.
- Use of the anchor only as supplied by the manufacturer without exchanging any component of the anchor.

- Anchor installation in accordance with the manufacturer's specifications and drawings using the tools indicated in this European technical approval.
- Checks before placing the anchor, to ensure that the characteristic values of the base material in which the anchor is to be placed, is identical with the values, which the characteristic loads apply for.
- Observation of the drill method according Annex 10 (Drill holes in hollow or perforated masonry may only be drilled using the rotary drill. Other drilling methods may also be used if job-site tests according to 4.4 evaluate the influence of hammer or impact drilling.).
- Placing drill holes without damaging the reinforcement.
- Observation of the different overall plastic anchor embedment depths:

EJOT SDF 10V	$h_{nom,1} \geq 40$ mm [only for concrete]
	$h_{nom,2} \geq 50$ mm [for concrete and solid masonry]
EJOT SDF 10H:	$h_{nom} \geq 70$ mm [for concrete and solid masonry]
	$h_{nom} = 70$ mm [for hollow or perforated masonry – compare 4.2.4]
- Holes to be cleaned of drilling dust.
- In case of aborted hole: New drilling at a minimum distance away of twice the depth of the aborted hole or smaller distance if the aborted drill hole is filled with high strength mortar.
- The plastic sleeve is inserted through the fixture by slight hammer blows and the special screw is screwed in until the head of the screw touches the sleeve. The anchor is correct mounted, if there is no turn-through of the plastic sleeve in the drill hole and if slightly move on turning of the screw is impossible after the complete turn-in of the screw.
- Temperature during installation of the anchor ≥ -10 °C (plastic sleeve and base material).

4.4 Job site tests according to ETAG 020, Annex B

4.4.1 General

In the absence of national requirements the characteristic resistance of the plastic anchor may be determined by job site tests, if the plastic anchor has already characteristic values given in Annex 6 and 8 to 10 for the same base material as it is present on the construction works.

Furthermore job site tests for use in different concrete, solid masonry and hollow or perforated masonry are possible only if the plastic anchor has already characteristic values given in Annex 6 and 8 to 10 for use in the equivalent base material.

Job site tests are also possible, if another drill method is been used as it is given in Annex 10.

The characteristic resistance to be applied to a plastic anchor should be determined by means of at least 15 pull-out tests carried out on the construction work with a centric tension load acting on the plastic anchor. These tests may also performed in a laboratory under equivalent conditions as used on construction work

Execution and evaluation of the tests as well as issue of the test report and determination of the characteristic resistance should be supervised by the person responsible for execution of works on site and be carried out by a competent person.

Number and position of the plastic anchors to be tested should be adapted to the relevant special conditions of the construction work in question and, for example, in the case of blind and larger areas be increased such that a reliable information about the characteristic resistance of the plastic anchor embedded in the base material in question can be derived. The tests should take account of the unfavourable conditions of practical execution.

4.4.2 Assembly

The plastic anchor to be tested shall be installed (e. g. preparation of drill hole, drilling tool to be used, drill bit, type of drilling hammer or rotation, thickness of fixture) and as far as spacing and edge distances are concerned be distributed in the same way as foreseen for the intended use.

Depending on the drilling tool hard metal hammer drill bits or hard metal percussion drill bits, respectively, according to ISO 5468 should be used. New drill bits should be used for one test series or drill bits with $d_{\text{cut,m}} = 10,25 \text{ mm} < d_{\text{cut}} \leq 10,45 \text{ mm} = d_{\text{cut,max}}$.

4.4.3 Execution of test

The test rig used for the pull-out tests shall provide a continuous slow increase of the load, controlled by a calibrated load cell. The load shall apply perpendicular to the surface of the base material and shall be transmitted to the anchor via a hinge. The reaction forces shall be transmitted into the base material such that possible breakout of the masonry is not restricted. This condition is considered as fulfilled, if the support reaction forces are transmitted either in adjacent masonry units or at a distance of at least 150 mm from the plastic anchors. The load shall be increased continuously in a way that the ultimate load is reached after about 1 minute. The load is measured when the ultimate load (N_1) is achieved.

If no pull-out failure occurs, other test methods are needed, e.g. proof-loading.

4.4.4 Test report

The test report shall include all information necessary to assess the resistance of the tested anchor. It shall be given to the person responsible for the design of the fastening and shall be included in the construction dossier.

The minimum data required are:

- Name of product
- Construction site, owner of building; date and location of the tests, air temperature
- Test rig
- Type of structure to be fixed
- Base material (e.g. type of brick, strength class, all dimensions of bricks, mortar group if possible); visual assessment of masonry (flush joints, joint clearance, regularity)
- Plastic anchor and special screw
- value of the cutting diameter of hard metal hammer-drill bits, measured before and after drilling if no new drill bits are used
- Results of tests including the indication of value N_1 ; mode of failure
- Tests carried out or supervised by ...; signature

4.4.5 Evaluation of test results

The characteristic resistance F_{RK1} is derived from the measured values N_1 as follows

$$F_{RK1} = 0,5 \cdot N_1$$

The characteristic resistance F_{RK1} has to be equal or smaller than the characteristic resistance F_{RK} which is given in the ETA for the equivalent base material

$$N_1 = \text{the mean value of the five smallest measured values at ultimate load}$$

In absence of national regulations the partial safety factors for the resistance of the plastic anchor may be taken as $\gamma_{Mc} = 1,8$ for use in concrete and $\gamma_{Mm} = 2,5$ for use in masonry.

5 Indications to the manufacturer

5.1 Responsibility of the manufacturer

It is in the responsibility of the manufacturer to ensure that the information on the specific conditions according to 1 and 2 including Annexes referred to 4 is given to those who are concerned. This information may be made by reproduction of the respective parts of the European technical approval. In addition, all installation data shall be shown clearly on the packaging and/or on an enclosed instruction sheet, preferably using illustrations.

The minimum data required are:

- base material for the intended use,
- ambient temperature of the base material during installation of the anchor,
- drill bit diameter (d_{cut}),
- overall anchor embedment depth in the base material (h_{nom}),
- minimum hole depth (h_0),
- information on the installation procedure,
- identification of the manufacturing batch.

All data shall be presented in a clear and explicit form.

5.2 Packaging, transport and storage

The anchor shall only be packaged and supplied as a complete unit.

The anchor shall be stored under normal climatic conditions in its original light-proof packaging. Before installation, it shall not be extremely dried nor frozen.

Uwe Bender
Head of Department

beglaubigt:
Bürger

SDF-10V

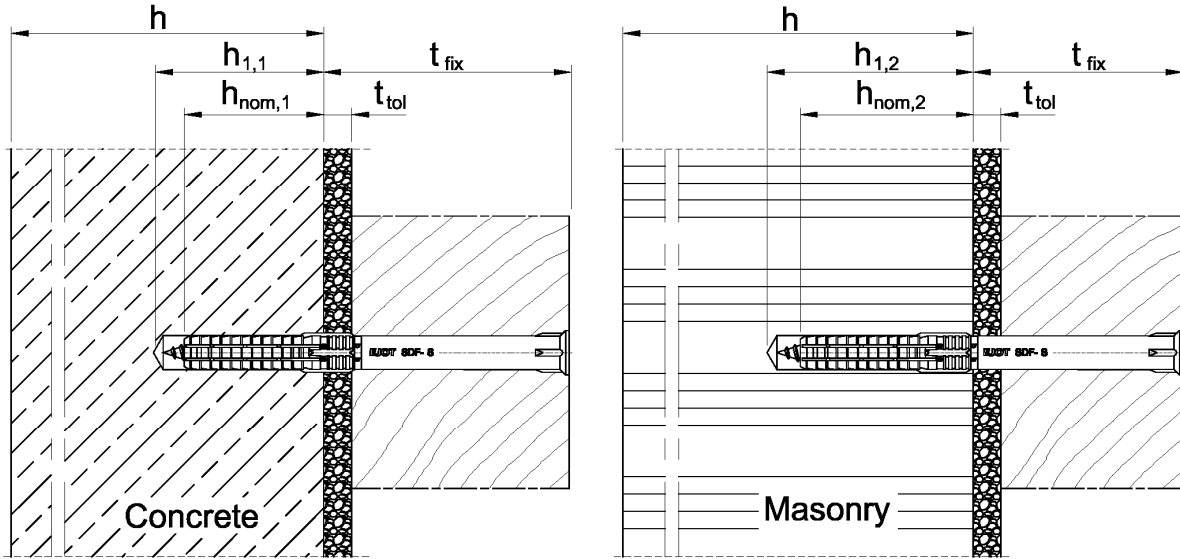

SDF-10H

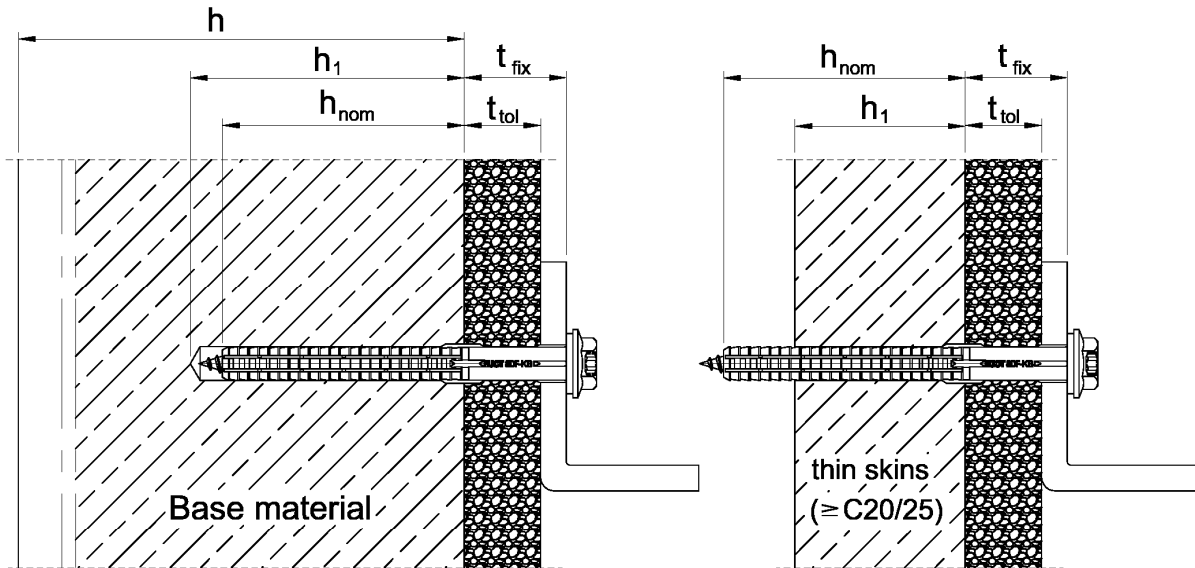

Intended use

- Anchorage in concrete [including thin skins (weather resistant skins of external wall panels)] and masonry

- Legend:** $h_{nom,1}$, $h_{nom,2}$ = overall plastic anchor embedment depth in the base material SDF 10V
 h_{nom} = overall plastic anchor embedment depth in the base material SDF 10H
 h = thickness of member (wall)
 h_1 = depth of drilled hole to deepest point
 t_{fix} = t_{tol} + thickness of fixture
 t_{tol} = thickness of equalizing layer or non-load-bearing coating

EJOT SDF 10V and EJOT SDF 10H

Intended use

Annex 1





SDF-KB Ø10V x L	SDF-S Ø10V x L
Plastic sleeve	
Special screw	
Stair bolt	
SDF-KB Ø10H x L	SDF-S Ø10H x L
Plastic sleeve	
Special screw	
Stair bolt	
Marking:	
<p>Anchor: Identifying mark (EJOT) Anchor type (e.g. SDF-KB) Diameters of anchor (Ø10) and Type (e.g. V) Length of anchor (e.g. 100) Marking the category of use (e.g. a) in the embedment zone of the plastic sleeve</p>	
Screw: Length of anchor (e.g. 100)	
EJOT SDF 10V and EJOT SDF 10H	Annex 2
Marking - Anchor type, special screw	

Table 1: Dimensions

Measure in mm

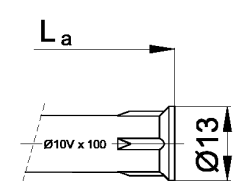
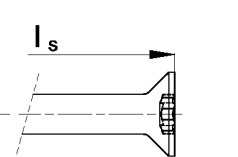
Anchor Type	Colour	Anchor sleeve					accompanying specific screw		
		d_{nom}	$h_{nom,1}$	$h_{nom,2}$	min L_a	max L_a	d_s	c_1	c
SDF-KB Ø10V	blue	10	40	50	50	220	7,0	--	35
SDF-S Ø10V	blue	10	40	50	50	220	7,0	--	35
			h_{nom}						
SDF-KB Ø10H	orange	10	70		80	300	7,0	55	80
SDF-S Ø10H	orange	10	70		80	300	7,0	55	80

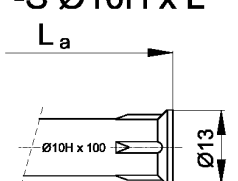
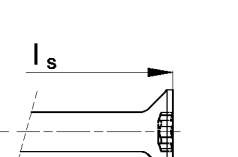
Table 2: Materials

Name	Materials
Anchor sleeve	Polyamide, PA6, Colour see Table 1
Specific screw	Steel, electrogalvanized $\geq 5 \mu\text{m}$ according to EN ISO 4042,
	stainless steel, material number 1.4401 or 1.4571 according to ISO 3506

Table 3: Installation parameters

Anchor type	SDF-KB Ø10V SDF-S Ø10 V		SDF-KB Ø10H SDF-S Ø10H
	a	b	a, b, c
Use category ¹⁾			
Drill hole diameter	d_0 [mm] =	10	10
Cutting diameter of drill bit	d_{cut} [mm] \leq	10,45	10,45
Depth of drilled hole to deepest point	$h_{1,1}$ [mm] \geq	50	—
Overall plastic anchor embedment depth in the base material	$h_{nom,1}$ [mm] \geq	40	—
Depth of drilled hole to deepest point	$h_{1,2}$ [mm] \geq	—	60
Overall plastic anchor embedment depth in the base material	$h_{nom,2}$ [mm] \geq	—	50
Depth of drilled hole to deepest point	h_1 [mm] \geq	—	—
Overall plastic anchor embedment depth in the base material	$h_{nom}^{2)}$ [mm] \geq	—	—
Diameter of the clearance hole in the fixture	d_f [mm] \leq	10,5	10,5

¹⁾ Use category: a - concrete; b - solid block; c - hollow block

²⁾ For hollow or perforated masonry the influence of $h_{nom} > 70$ mm has to be detected by job site tests according 4.4

EJOT SDF 10V and EJOT SDF 10H

Dimensions, materials, installation parameters

Annex 3

Table 4: Characteristic bending resistance of the screw in concrete and masonry

Anchor Type	SDF-KB Ø10V SDF-S Ø10 V		SDF-KB Ø10H SDF-S Ø10H	
	galvanised steel	stainless steel	galvanised steel	stainless steel
Material				
Characteristic bending resistance $M_{Rk,s}$ [Nm]	13,80 ²⁾ 23,01 ³⁾	16,09 ²⁾ 26,62 ³⁾	17,67	20,62
Partial safety factor γ_{Ms} ¹⁾	1,25	1,56	1,25	1,56

¹⁾ In absence of other national regulations

²⁾ In case of $h_{nom,1}$

³⁾ In case of $h_{nom,2}$

Table 5: Characteristic resistance of the screw for use in concrete (use category "a")

Failure of expansion element (special screw)	SDF-KB Ø10V SDF-S Ø10 V		SDF-KB Ø10H SDF-S Ø10H	
	galvanised steel	stainless steel	galvanised steel	stainless steel
Characteristic tension resistance $N_{Rk,s}$ [kN]	15,85	18,49	18,70	21,82
Partial safety factor γ_{Ms} ¹⁾	1,5	1,87	1,5	1,87
Characteristic shear resistance $V_{Rk,s}$ [kN]	7,93 ²⁾ 11,09 ³⁾	9,12 ²⁾ 12,94 ³⁾	9,35	10,91
Partial safety factor γ_{Ms} ¹⁾	1,25	1,56	1,25	1,56

¹⁾ In absence of other national regulations

²⁾ In case of $h_{nom,1}$

³⁾ In case of $h_{nom,2}$

EJOT SDF 10V and EJOT SDF 10H

Characteristic resistance of the screw

Annex 4

**Table 6: Characteristic resistance for pull-out failure (plastic sleeve)
for use in concrete (use category "a")**

Pull-out failure in standard concrete slabs		SDF-KB Ø10V SDF-S Ø10 V		SDF-KB Ø10H SDF-S Ø10H	
Embedment depth	h_{nom} [mm] \geq	40		70	
Temperature range		30/50 °C	50/80 °C	30/50 °C	50/80 °C
Concrete \geq C12/15					
Characteristic resistance	$N_{Rk,p}$ [kN]	4,50	4,00	4,50	4,00
Partial safety factor	γ_{Mc} ¹⁾	1,8			
Pull-out failure in thin skins (h = 50 to 100 mm)		SDF-KB Ø10V SDF-S Ø10 V		SDF-KB Ø10H SDF-S Ø10H	
Embedment depth	h_{nom} [mm] \geq	—		70	
Temperature range		30/50 °C	50/80 °C	30/50 °C	50/80 °C
Concrete \geq C20/25					
Characteristic resistance	$N_{Rk,p}$ [kN]	—	—	3,00	3,00
Partial safety factor	γ_{Mc} ¹⁾	1,8			

¹⁾ In absence of other national regulations

EJOT SDF 10V and EJOT SDF 10H

Characteristic resistance in concrete (use category "a")

Annex 5

Table 7: Characteristic resistance for use in concrete (use category "a")

<p>Tension load ²⁾</p> $N_{Rk,c} = 7,2 \times \sqrt{f_{ck, \text{cube}}} \times h_{ef}^{1,5} \times \frac{C}{C_{cr,N}} = N_{Rk,p} \times \frac{C}{C_{cr,N}} \quad \text{mit: } h_{ef}^{1,5} = \frac{N_{Rk,p}}{7,2 \times \sqrt{f_{ck, \text{cube}}}}$ $\frac{C}{C_{cr,N}} \leq 1$	
<p>Shear load ²⁾³⁾</p> $V_{Rk,c} = 0,45 \times \sqrt{d_{nom}} \times \left(\frac{h_{nom}}{d_{nom}}\right)^{0,2} \times \sqrt{f_{ck, \text{cube}}} \times c_1^{1,5} \times \left(\frac{c_2}{1,5c_1}\right)^{0,5} \times \left(\frac{h}{1,5c_1}\right)^{0,5} \quad \text{with: } \left(\frac{c_2}{1,5c_1}\right)^{0,5} \leq 1$ <p> c_1 Edge distance closed to the edge in loading direction c_2 Edge distance perpendicular to direction 1 $f_{ck, \text{cube}}$ Nominal characteristic concrete compression strength (based on cubes) value for C50/60 at maximum $\left(\frac{h}{1,5c_1}\right)^{0,5} \leq 1$ </p>	
Partial safety factor	γ_{Mc} ¹⁾ 1,8

¹⁾ In absence of other national regulations

²⁾ The design method according to ETAG 020, Annex C, is to be used

³⁾ Only for thin skins: Due to concrete break out during the drilling process " h_{nom} " and " h " have to be replaced by " $(h - 10 \text{ mm})$ " in the formulas. $h = \text{thickness of thin skin} \geq 50 \text{ mm}$

Table 8: Displacements under tension and shear loading in concrete ¹⁾, masonry ¹⁾

Anchor Type	Tension load			Shear load		
	F [kN]	δ_{NO} [mm]	$\delta_{N\infty}$ [mm]	F [kN]	δ_{VO} [mm]	$\delta_{V\infty}$ [mm]
SDF-S Ø10V / SDF-KB Ø10V	1,8	0,36	0,72	1,8	0,41	0,82
SDF-S Ø10H / SDF-KB Ø10H	1,8	0,37	0,74	1,8	0,41	0,82

¹⁾ Valid for all ranges of temperatures

EJOT SDF 10V and EJOT SDF 10H

Characteristic resistance in concrete (use category "a")
Displacements

Annex 6

Table 9: Minimum thickness of member, edge distance and spacing in concrete

SDF Ø10V/ In case a fixing point consists of more than one anchor with spacing of $a \leq 80$ mm, SDF Ø10H: this fixing point is considered as a group with a max. characteristic resistance $N_{Rk,p}$ acc. to Table 6. For $a > 80$ mm, the anchors are always considered as single anchors, each with a characteristic resistance $N_{Rk,p}$ acc. to Table 6.

Anchor Type		Minimum thickness of member h_{min} [mm]	Characteristic edge distance $c_{Cr,N}$ [mm]	Minimum allowable spacing and edge distances [mm]
SDF Ø10V	Concrete \geq C16/20	100	80	$s_{min} = 60$ for $c_{min} \geq 50$
	Concrete C12/15		110	$s_{min} = 85$ for $c_{min} \geq 70$
SDF Ø10H	Concrete \geq C16/20	100	80	$s_{min} = 60$ for $c_{min} \geq 50$
	Concrete C12/15		110	$s_{min} = 85$ for $c_{min} \geq 70$
	Concrete C20/25 (thin skins)	50	160	$s_{min} = 80$ for $c_{min} \geq 160$

Scheme of distances and spacing in concrete

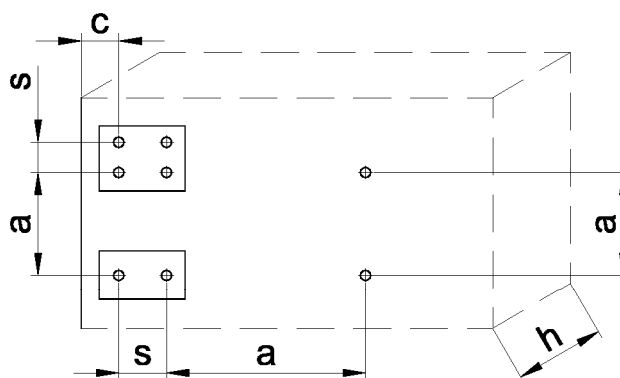

EJOT SDF 10V and EJOT SDF 10H

Minimum thickness of member
Minimum spacing and distance in concrete

Annex 7

Table 10: SDF 10V - characteristic resistance $F_{RK}^{1)}$ in [kN] in solid masonry
(use category "b") with $h_{nom,2} \geq 50$ mm

Base material [Supplier / Title]	Min. DF or min. size (L x W x H) [mm]	Bulk density class ρ [kg/dm ³]	Minimum compressive strength f_b [N/mm ²]	Drill method	Characteristic resistance $F_{RK}^{1)}$ in kN SDF 10V	
					30/50°C	50/80°C
Clay brick, Mz DIN 105 - 100 EN 771-1 e.g. Schlagmann, Mz	2 DF (240x115x113)	$\cong 1,8$	20	H ²⁾	2,50	2,50
			10		2,00	1,50
Sand-lime solid blocks, KS DIN V 106 EN 771-2 e.g. Unika	NF (240x115x71)	$\cong 2,0$	36	H ²⁾	4,00	4,00
			20		2,00	2,00
			10		1,50	1,50
Sand-lime solid blocks, KS DIN V 106 EN 771-2 e.g. Unika see Annex 12 , Fig. 1	8 DF (248x240x238)	$\cong 1,8$	20	H ²⁾	4,50	4,50
			10		3,00	3,00
Lightweight concrete solid block, V DIN V 18152 - 100 EN 771-3 Fa. Nütling, Liapor V6	2 DF (240x115x113)	$\cong 1,2$	6	H ²⁾	0,30	0,30
Partial safety factor		$\gamma_{Mm}^{3)}$	2,5			

1) Characteristic resistance F_{RK} for tension, shear or combined tension and shear loading.
The characteristic resistance is valid for single anchor or for a group of two or four plastic anchors with a spacing equal or larger than the minimum spacing s_{min} according to Table 13.
The specific conditions for the design method have to be considered according to chapter 4.2.5 of the ETA.

2) H = Hammer drilling, R = Rotary drilling

3) In absence of other national regulations

EJOT SDF 10V and EJOT SDF 10H

Anchor type SDF 10V with $h_{nom,2} \geq 50$ mm:
characteristic resistance in solid masonry (use category "b")

Annex 8

Table 11: SDF 10H - characteristic resistance $F_{Rk}^{1)}$ in [kN] in solid masonry
(use category "b") with $h_{nom} \geq 70$ mm

Base material [Supplier / Title]	Min. DF or min. size (L x W x H) [mm]	Bulk density class ρ [kg/dm ³]	Minimum compressive strength f_b [N/mm ²]	Drill method	Characteristic resistance $F_{Rk}^{1)}$ in kN SDF 10H	
					30/50°C	50/80°C
Clay brick, Mz DIN 105 - 100 EN 771-1 e.g. Schlagmann	2 DF (240x115x113)	$\geq 1,8$	20	H ²⁾	4,00	4,00
			10		3,00	3,00
Sand-lime solid blocks, KS DIN V 106 EN 771-2 e.g. Unika	NF (240x115x71)	$\geq 2,0$	36	H ²⁾	4,50	4,50
			20		2,50	2,50
			10		1,50	1,50
Sand-lime solid blocks, KS DIN V 106 EN 771-2 e.g. Unika see Annex 12 , Fig. 1	8 DF (248x240x238)	$\geq 1,8$	20	H ²⁾	4,50	4,50
			10		3,50	3,50
Lightweight concrete solid brick, V DIN V 18152 - 100 EN 771-3 Fa. Nütling, Liapor V6	2 DF (240x115x113)	$\geq 1,2$	6	H ²⁾	2,00	2,00
			4		1,20	1,20
Lightweight concrete solid block, Vbl DIN V 18152 - 100 EN 771-3 Fa. Nüdling, FCN Liapor	(1200x800x200)	$\geq 1,0$	4	H ²⁾	2,00	2,00
			2		0,90	0,90
Partial safety factor		$\gamma_{Mm}^{3)}$	2,5			

1) Characteristic resistance F_{Rk} for tension, shear or combined tension and shear loading.
The characteristic resistance is valid for single anchor or for a group of two or four plastic anchors with a spacing equal or larger than the minimum spacing s_{min} according to Table 13. The specific conditions for the design method have to be considered according to chapter 4.2.5 of the ETA.

2) H = Hammer drilling, R = Rotary drilling

3) In absence of other national regulations

EJOT SDF 10V and EJOT SDF 10H

Anchor type SDF 10H with $h_{nom} \geq 70$ mm:
characteristic resistance in solid masonry (use category "b")

Annex 9

**Table 12: SDF 10H - characteristic resistance $F_{RK}^{1)}$ in [kN] in hollow or perforated masonry (use category "c") with $h_{nom} = 70$ mm
(The influence of $h_{nom} > 70$ mm has to be detected by job-site tests according 4.4)**

Base material [Supplier / Title]	Min. DF or min. size (L x W x H) [mm]	Bulk density class ρ [kg/dm ³]	Minimum compressive strength f_b [N/mm ²]	Drill method	Characteristic resistance $F_{RK}^{1)}$ in kN SDF 10H	
					30/50°C	50/80°C
Vertically perforated clay brick, HLz DIN 105 - 100 EN 771-1 e.g. Unipor see Annex 12 , Fig. 4	2 DF (240x115x113)	$\geq 1,2$	20	R ²⁾	1,50	1,50
			12		0,90	0,90
Vertically perforated clay brick, HLz DIN 105 - 100 EN 771-1 e.g. Unipor see Annex 12 , Fig. 6	NF (240x115x71)	$\geq 0,9$	12	R ²⁾	2,00	2,00
			8		1,50	1,50
			6		0,90	0,90
Sand-lime perforated bricks, KSL DIN V 106 EN 771-2 e.g. Unika see Annex 12 , Fig. 3	4DF (248x115x238)	$\geq 1,6$	12	R ²⁾	2,50	2,50
			10		2,00	2,00
			8		1,50	1,50
Sand-lime perforated bricks, KSL DIN V 106 EN 771-2 e.g. Unika see Annex 12 , Fig. 2	8DF (248x240x238)	$\geq 1,4$	16	R ²⁾	1,50	1,50
			12		1,20	1,20
			8		0,90	0,90
			6		0,60	0,60
Lightweight concrete hollow block, Hbl DIN 18151 EN 771-3 Nüdling see Annex 12 , Fig. 5	12DF (375x240x238)	$\geq 1,2$	10	R ²⁾	1,20	1,20
			8		0,90	0,90
			6		0,75	0,75
			4		0,50	0,50
Partial safety factor		$\gamma_{Mm}^{3)}$	2,5			

For footnotes 1), 2), 3) see Annex 8

EJOT SDF 10V and EJOT SDF 10H

Anchor type SDF 10V with $h_{nom} = 70$ mm:
characteristic resistance in hollow or perforated masonry (use category "c")

Annex 10

Table 13: Minimum distances and dimensions in masonry

Anchor type		SDF 10V	SDF 10H
Minimum thickness of member	h_{\min} [mm]	100	100
Single anchor			
Minimum allowable spacing	a_{\min} [mm]	250	250
Minimum allowable edge distance	c_{\min} [mm]	100	100
Anchor group			
Minimum allowable spacing perpendicular to free edge	$s_{1, \min}$ [mm]	100	100
Minimum allowable spacing parallel to free edge	$s_{2, \min}$ [mm]	100	100
Minimum allowable edge distance	c_{\min} [mm]	100	100

Scheme of distances and spacing in masonry

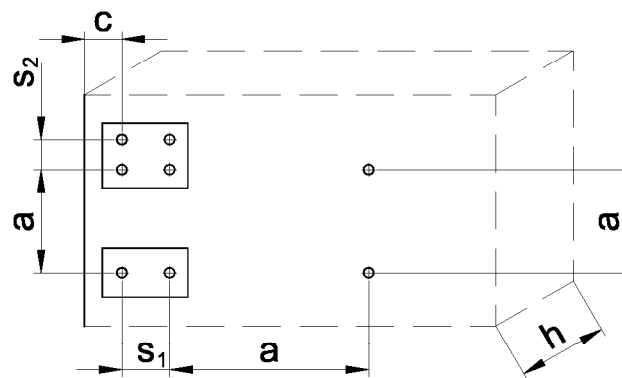

EJOT SDF 10V and EJOT SDF 10H

Minimum thickness of member
Minimum spacing and distance in masonry

Annex 11

Table 14: Geometry of stones

Figure 1

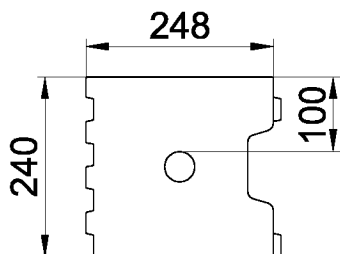

Figure 2

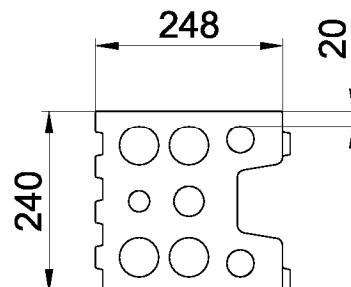

Figure 3

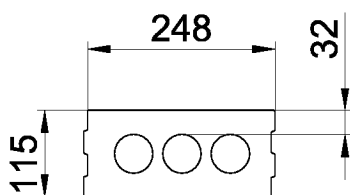

Figure 4

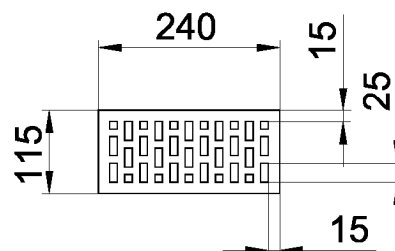

Figure 5

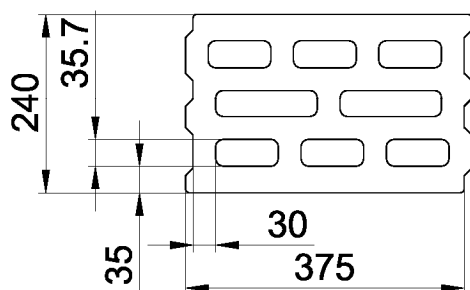
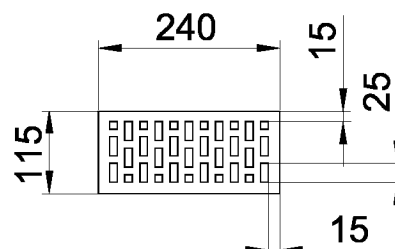

Figure 6



EJOT SDF 10V and EJOT SDF 10H

Geometry of stones

Annex 12