

ET3362 Cermet Trimming Potentiometer

ELECSOUND®

Features:

Square/Single-Turn/ Cermet/ Industrial/ Sealed
10 Terminal Styles
RoHS Compliant

Electrical Characteristics

Standard Resistance Range: 10Ω - 2MΩ
Resistance Tolerance: ±10% std.
Absolute Minimum Resistance: ≤1% or 2Ω
Contact Resistance Variation: ≤3% or 3Ω
Insulation Resistance : R1 ≥1,000 MegΩ
Withstand Voltage : 700VAC
Effective Travel: 250° normal

Environmental Characteristics

Power Rating:(315V max)0.5W@70°C,0W@125°C
Temperature Range: -55°C to +125°C
Temperature Coefficient: ±100ppm/°C
Vibration:10-500Hz,0.75mm,6Hour:ΔR≤±5%
Shock: 390m/s, 4000cycles, ΔR≤±5%
Endurance:0.5W@70°C,1000H,ΔR≤10%
Rotational Life: 200Cycles,ΔR≤±5%

How to order:

ET3362 P - 1 - 502

Model _____
Style _____
Standard or Modified _____
Product Indicator _____
-1 = Standard Product
Resistance Code _____

Physical Characteristics

Starting Torque: ≤30mN·m
Flammability: UL.94V-0
Marking: Resistance code, Model
Standard Packaging: 50pcs per tube

Standard Resistance Table:

Resistance (Ohms)	Resistance Code
10	100
20	200
50	500
100	101
200	201
500	501
1000	102
2000	202
5000	502
10000	103
20000	203
25000	253
50000	503
100000	104
200000	204
250000	254
500000	504
1000000	105
2000000	205



Common Dimensions Top Adjust

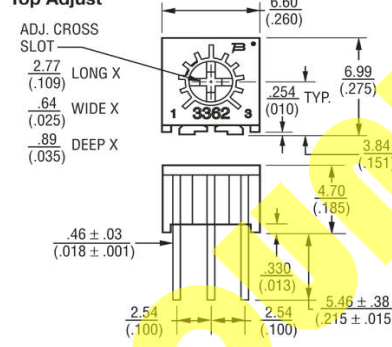

3362F

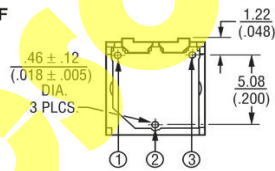

3362H

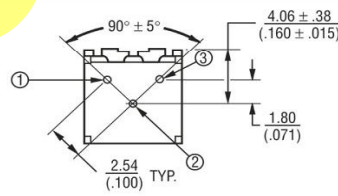

3362P

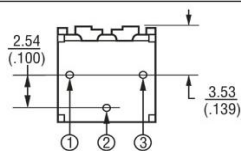

3362R

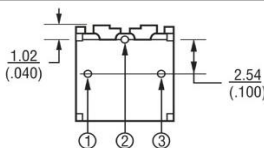

3362U

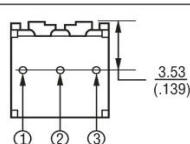

Common Dimensions Side Adjust

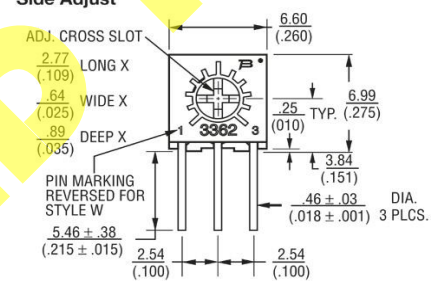

3362M

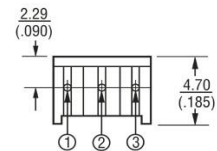

3362S

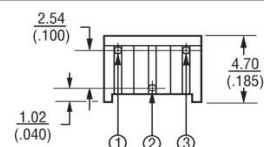

3362W

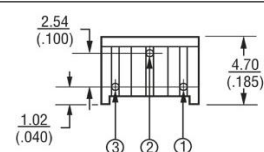

3362X

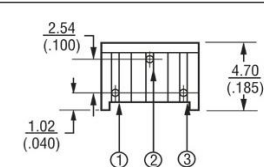

3362Z

