

ELM75xxxxC CMOS Small package voltage detector

<http://www.elm-tech.com>

■ General description

ELM75xxxxC is CMOS voltage detector provides lower current consumption-Typ.0.4 μ A(Vdd=VdetN+1V) and high accuracy ($\pm 2.0\%$) of detection voltage. It consists of very low-power-consumption reference voltage source, hysteresis comparator, output driver and detection voltage setting resistor. The output is positive logic; therefore, the output becomes low level when Vdd is lower than detection voltage. There are two output styles of ELM75 series: N-ch opendrain and CMOS output. The standard detection voltages are 1.1V, 2.2V, 2.4V, 2.7V, 3.0V and 4.0V; ELM75 series can also be made as semi-custom IC within the range of 0.9 to 5.5V by 0.1V step.

■ Features

- Detection voltage range : 0.9V to 5.5V (by 0.1V)
- Low current consumption : Typ.0.4 μ A(Vdd=VdetN+1V)
- Accuracy of detection voltage : $\pm 2.0\%$
- Low temperature coefficient : Typ.+100ppm/ $^{\circ}$ C
- Package : SOT-89, SOT-23, SC-70-5(SOT-353), SC-82AB(SOT-343)

■ Application

- Reset for microcomputers
- Voltage power shortage detectors
- Switch of back up power source
- Battery checkers

■ Maximum absolute ratings

Parameter	Symbol	Limit	Unit
Power supply voltage	Vdd	Vss-0.3 to 8.0	V
Output voltage	Vout	N-ch : Vss-0.3 to +8.0	V
		CMOS : Vss-0.3 to Vdd+0.3	
Output current	Iout	100	mA
Power dissipation	Pd	500 (SOT-89)	mW
		250 (SOT-23)	
		150 (SC-70-5)(SOT-353)	
		150 (SC-82AB)(SOT-343)	
Operating temperature	Top	-40 to +85	$^{\circ}$ C
Storage temperature	Tstg	-55 to +125	$^{\circ}$ C

ELM75xxxxC CMOS Small package voltage detector

<http://www.elm-tech.com>

■ Selection guide

ELM75xxxxC-x

Symbol		
a, b	Detection voltage	e.g. : 11: VdetN=1.1V, 22: VdetN=2.2V 24: VdetN=2.4V, 27: VdetN=2.7V 30: VdetN=3.0V, 40: VdetN=4.0V
c	Output form	C: CMOS output N: N-ch open-drain output
d	Package	A: SOT-89 B: SOT-23 C: SC-70-5(SOT-353), SC-82AB(SOT-343)
e	Pin configuration type	1: Type1 2: Type2(ELM75xxxC2C only) 3: Type3(ELM75xxxC3C only) 4: Type4(ELM75xxxC4C only)
f	Product version	C
g	Taping direction	S, N: Refer to PKG file

ELM75 x x x x x C - x
 ↑ ↑ ↑ ↑ ↑ ↑ ↑
 a b c d e f g

■ Pin configuration

SOT-89(TOP VIEW)

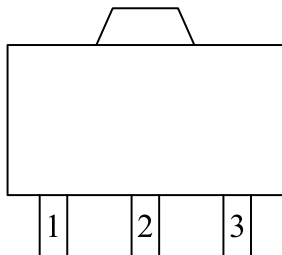

Pin No.	Pin name
	(75xxxA1C)
1	OUT
2	VDD
3	VSS

SOT-23(TOP VIEW)

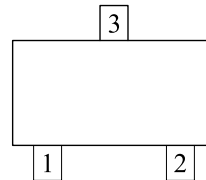

Pin No.	Pin name
	(75xxxB1C)
1	OUT
2	VSS
3	VDD

SC-70-5(TOP VIEW)

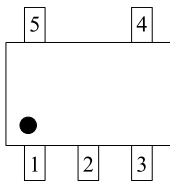

Pin No.	Pin name		
	(75xxxC1C)	(75xxxC2C)	(75xxxC3C)
1	NC	OUT	NC
2	VDD	NC	VDD
3	NC	VDD	NC
4	OUT	NC	VSS
5	VSS	VSS	OUT

SC-82AB(TOP VIEW)

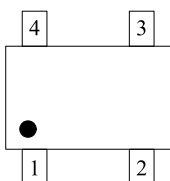

Pin No.	Pin name
	(75xxxC4C)
1	OUT
2	VDD
3	NC
4	VSS

ELM75xxxxC CMOS Small package voltage detector

<http://www.elm-tech.com>

■ Standard circuit

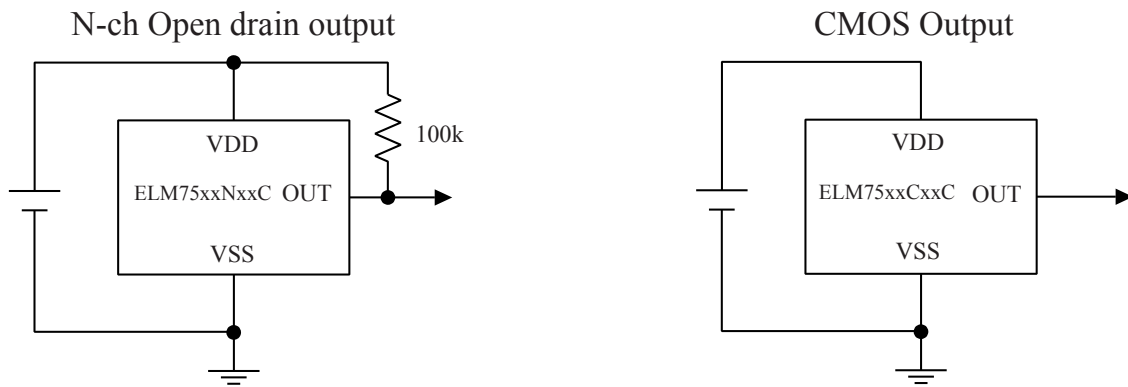

■ Block diagram

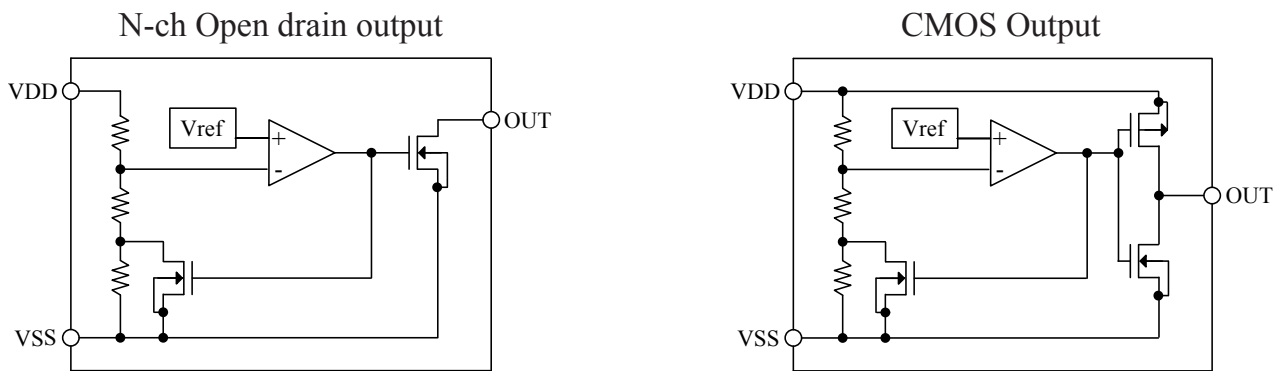

■ Timing chart

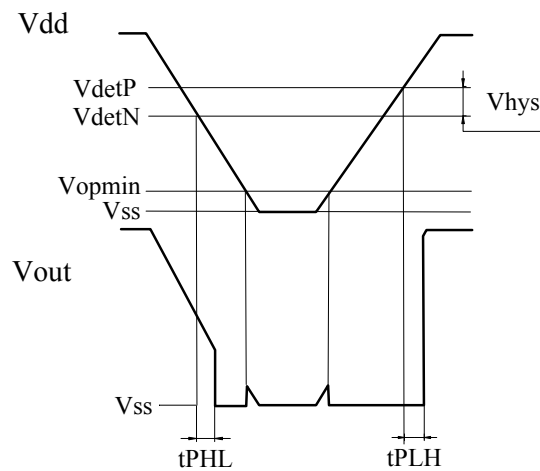

ELM75xxxxC CMOS Small package voltage detector

<http://www.elm-tech.com>

■Electrical characteristics

VdetN=1.1V(ELM7511xxxC)

Top=25°C

Parameter	Symbol	Condition	Min.	Typ.	Max.	Unit	Note*
Detection voltage	VdetN		1.078	1.100	1.122	V	2
Hysteresis width	Vhys		VdetN× 0.02	VdetN× 0.04	VdetN× 0.08	V	2
Current consumption	I _{ss}	Vdd=2.1V		0.4	1.8	μA	1
Power voltage	Vdd		0.8		6.0	V	2
Output current	IoutN1	Vdd=0.8V, Vds=0.4V	0.01	0.50		mA	3-(1)
	IoutN2	Vdd=1.0V, Vds=0.4V	0.50	2.70			
	IoutP*	Vdd=1.5V, Vds=0.4V	0.10	0.30		mA	3-(2)
Delay time	tPLH	Vdd=0.8V to 1.5V		20		μs	4
	tPHL	Vdd=1.5V to 0.8V		60			
Temperature characteristic of VdetN	$\frac{\Delta V_{detN}}{\Delta T_{op}}$	Top=-40°C to +85°C		±100		ppm/°C	

* Note: test circuit No., IoutP is applied only for CMOS output products.

VdetN=2.2V(ELM7522xxxC)

Top=25°C

Parameter	Symbol	Condition	Min.	Typ.	Max.	Unit	Note*
Detection voltage	VdetN		2.156	2.200	2.244	V	2
Hysteresis width	Vhys		VdetN× 0.02	VdetN× 0.05	VdetN× 0.08	V	2
Current consumption	I _{ss}	Vdd=3.2V		0.4	1.8	μA	1
Power voltage	Vdd		0.8		6.0	V	2
Output current	IoutN1	Vdd=0.8V, Vds=0.4V	0.01	0.50		mA	3-(1)
	IoutN2	Vdd=1.0V, Vds=0.4V	0.50	2.70			
	IoutP*	Vdd=3.0V, Vds=0.4V	0.60	1.20		mA	3-(2)
Delay time	tPLH	Vdd=0.8V to 3.0V		60		μs	4
	tPHL	Vdd=3.0V to 0.8V		150			
Temperature characteristic of VdetN	$\frac{\Delta V_{detN}}{\Delta T_{op}}$	Top=-40°C to +85°C		±100		ppm/°C	

* Note: test circuit No., IoutP is applied only for CMOS output products.

VdetN=2.4V(ELM7524xxxC)

Top=25°C

Parameter	Symbol	Condition	Min.	Typ.	Max.	Unit	Note*
Detection voltage	VdetN		2.352	2.400	2.448	V	2
Hysteresis width	Vhys		VdetN× 0.02	VdetN× 0.05	VdetN× 0.08	V	2
Current consumption	I _{ss}	Vdd=3.4V		0.4	1.8	μA	1
Power voltage	Vdd		0.8		6.0	V	2
Output current	IoutN1	Vdd=0.8V, Vds=0.4V	0.01	0.50		mA	3-(1)
	IoutN2	Vdd=1.0V, Vds=0.4V	0.50	2.70			
	IoutP*	Vdd=3.0V, Vds=0.4V	0.60	1.20		mA	3-(2)
Delay time	tPLH	Vdd=0.8V to 3.0V		60		μs	4
	tPHL	Vdd=3.0V to 0.8V		150			
Temperature characteristic of VdetN	$\frac{\Delta V_{detN}}{\Delta T_{op}}$	Top=-40°C to +85°C		±100		ppm/°C	

* Note: test circuit No., IoutP is applied only for CMOS output products.

ELM75xxxxC CMOS Small package voltage detector

<http://www.elm-tech.com>

VdetN=2.7V(ELM7527xxxC)

Top=25°C

Parameter	Symbol	Condition	Min.	Typ.	Max.	Unit	Note*
Detection voltage	VdetN		2.646	2.700	2.754	V	2
Hysteresis width	Vhys		VdetN× 0.02	VdetN× 0.06	VdetN× 0.08	V	2
Current consumption	I _{ss}	Vdd=3.7V		0.4	1.8	μA	1
Power voltage	Vdd		0.8		6.0	V	2
Output current	IoutN1	Vdd=0.8V, Vds=0.4V	0.01	0.50		mA	3-(1)
	IoutN2	Vdd=1.0V, Vds=0.4V	0.50	2.70			
	IoutP*	Vdd=4.5V, Vds=0.4V	0.80	1.60		mA	3-(2)
Delay time	tPLH	Vdd=0.8V to 4.5V		70		μs	4
	tPHL	Vdd=4.5V to 0.8V		150			
Temperature characteristic of VdetN	$\frac{\Delta V_{detN}}{\Delta T_{op}}$	Top=-40°C to +85°C		+100		ppm/°C	

* Note: test circuit No., IoutP is applied only for CMOS output products.

VdetN=3.0V(ELM7530xxxC)

Top=25°C

Parameter	Symbol	Condition	Min.	Typ.	Max.	Unit	Note*
Detection voltage	VdetN		2.940	3.000	3.060	V	2
Hysteresis width	Vhys		VdetN× 0.02	VdetN× 0.06	VdetN× 0.08	V	2
Current consumption	I _{ss}	Vdd=4.0V		0.4	1.8	μA	1
Power voltage	Vdd		0.8		6.0	V	2
Output current	IoutN1	Vdd=0.8V, Vds=0.4V	0.01	0.50		mA	3-(1)
	IoutN2	Vdd=1.0V, Vds=0.4V	0.50	2.70			
	IoutP*	Vdd=4.5V, Vds=0.4V	0.80	1.60		mA	3-(2)
Delay time	tPLH	Vdd=0.8V to 4.5V		70		μs	4
	tPHL	Vdd=4.5V to 0.8V		150			
Temperature characteristic of VdetN	$\frac{\Delta V_{detN}}{\Delta T_{op}}$	Top=-40°C to +85°C		±100		ppm/°C	

* Note: test circuit No., IoutP is applied only for CMOS output products.

VdetN=4.0V(ELM7540xxxC)

Top=25°C

Parameter	Symbol	Condition	Min.	Typ.	Max.	Unit	Note*
Detection voltage	VdetN		3.920	4.000	4.080	V	2
Hysteresis width	Vhys		VdetN× 0.02	VdetN× 0.06	VdetN× 0.08	V	2
Current consumption	I _{ss}	Vdd=5.0V		0.4	1.8	μA	1
Power voltage	Vdd		0.8		6.0	V	2
Output current	IoutN1	Vdd=0.8V, Vds=0.4V	0.01	0.50		mA	3-(1)
	IoutN2	Vdd=1.0V, Vds=0.4V	0.50	2.70			
	IoutP*	Vdd=4.5V, Vds=0.4V	0.80	1.60		mA	3-(2)
Delay time	tPLH	Vdd=0.8V to 4.5V		70		μs	4
	tPHL	Vdd=4.5V to 0.8V		150			
Temperature characteristic of VdetN	$\frac{\Delta V_{detN}}{\Delta T_{op}}$	Top=-40°C to +85°C		±100		ppm/°C	

* Note: test circuit No., IoutP is applied only for CMOS output products.

ELM75xxxxxC CMOS Small package voltage detector

<http://www.elm-tech.com>

■ Test circuits

1) Current consumption

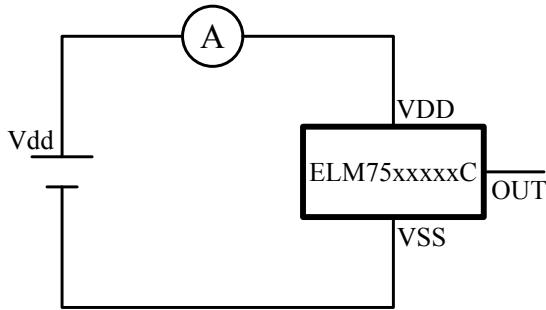

2) Detection voltage

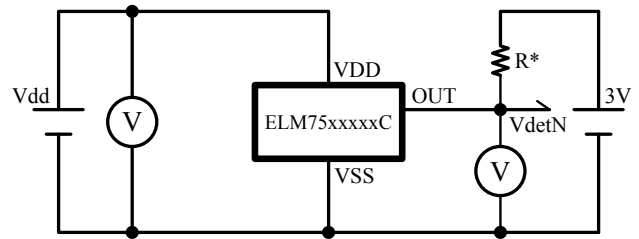

* Pull up circuit is necessary for N-ch output only.
* $R=100k\Omega$ ($R=1M\Omega$ for Vdd min measurement.)

3)-(1) Output current (N-ch)

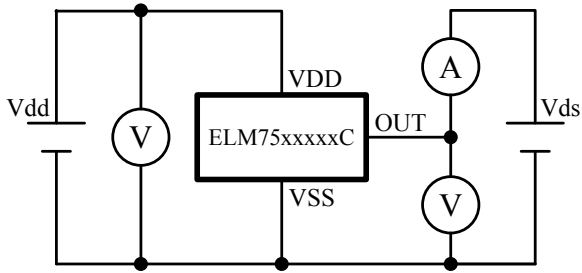

3)-(2) Output current (P-ch)

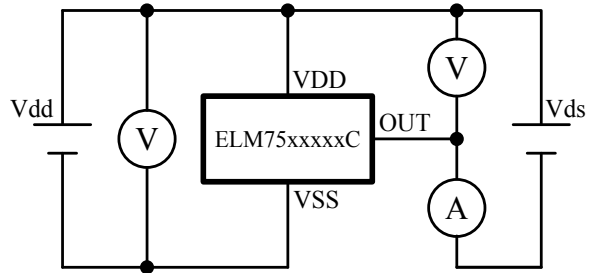

4) Delay time

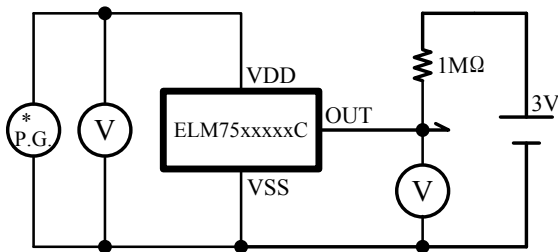

* Pull up circuit is necessary for N-ch output only.

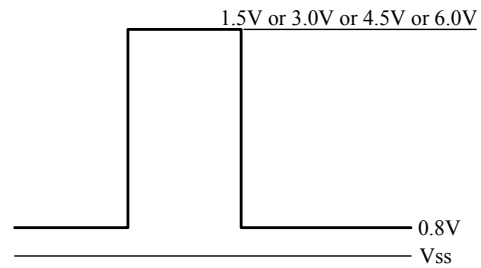

** Input pulse

ELM75xxxxxC CMOS Small package voltage detector

<http://www.elm-tech.com>

■ Marking

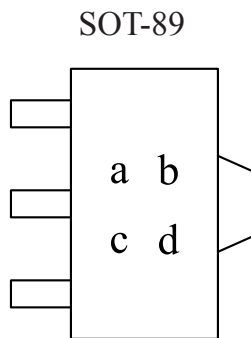

• SOT-89 package

a : Represents the integer of the detection voltage.

Symbol	VdetN	Symbol	VdetN
Y	0.*V	7	3.*V
9	1.*V	8	4.*V
6	2.*V	X	5.*V

b : Represents the decimal point of the detection voltage.

Symbol	VdetN	Symbol	VdetN
0	*.0V	5	*.5V
1	*.1V	6	*.6V
2	*.2V	7	*.7V
3	*.3V	8	*.8V
4	*.4V	9	*.9V

c : Represents the assembly lot number.

Symbol	Output form
A to Z repeated (I, O, X excepted)	N-ch
0 to 9 repeated	CMOS

d : Represents the assembly lot number.

Symbol	Output form
0 to 9 repeated	N-ch
A to Z repeated (I, O, X excepted)	CMOS

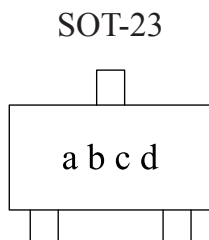

• SOT-23 package

a : Represents the integer of the detection voltage.

Symbol	VdetN	Symbol	VdetN
Y	0.*V	8	3.*V
0	1.*V	9	4.*V
7	2.*V	X	5.*V

b : Represents the decimal point of the detection voltage.

Symbol	VdetN	Symbol	VdetN
0	*.0V	5	*.5V
1	*.1V	6	*.6V
2	*.2V	7	*.7V
3	*.3V	8	*.8V
4	*.4V	9	*.9V

c : Represents the assembly lot number.

Symbol	Output form
A to Z repeated (I, O, X excepted)	N-ch
0 to 9 repeated	CMOS

d : Represents the assembly lot number.

Symbol	Output form
0 to 9 repeated	N-ch
A to Z repeated (I, O, X excepted)	CMOS

ELM75xxxxxC CMOS Small package voltage detector

<http://www.elm-tech.com>

• SC-70-5, SC-82AB package

a : Represents the detection voltage

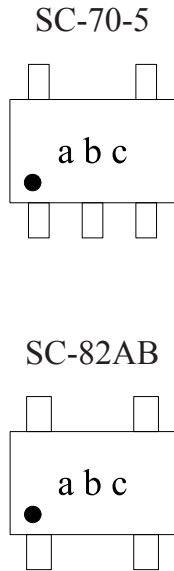

Symbol	VdetN	Symbol	VdetN
0	0.9V	M	3.3V
2	1.0V	N	3.4V
6	1.1V	P	3.5V
9	1.2V	Q	3.6V
*	1.3V	R	3.7V
Y	1.4V	S	3.8V
Z	1.5V	T	3.9V
1	1.6V	U	4.0V
÷	1.7V	#	4.1V
3	1.8V	5	4.2V
4	1.9V	%	4.3V
V	2.0V	=	4.4V
W	2.1V	7	4.5V
A	2.2V	▪	4.6V
B	2.3V	+	4.7V
C	2.4V	-	4.8V
D	2.5V	>	4.9V
E	2.6V	8	5.0V
F	2.7V	?	5.1V
G	2.8V	¥	5.2V
H	2.9V	<	5.3V
J	3.0V	/	5.4V
K	3.1V	X	5.5V
L	3.2V		

b : Represents the assembly lot number.

Symbol	Output form
A to Z repeated (I, O, X excepted)	N-ch
0 to 9 repeated	CMOS

c : Represents the assembly lot number.

Symbol	Output form
0 to 9 repeated	N-ch
A to Z repeated (I, O, X excepted)	CMOS

ELM75xxxxC CMOS Small package voltage detector

<http://www.elm-tech.com>

■ Current consumption characteristics

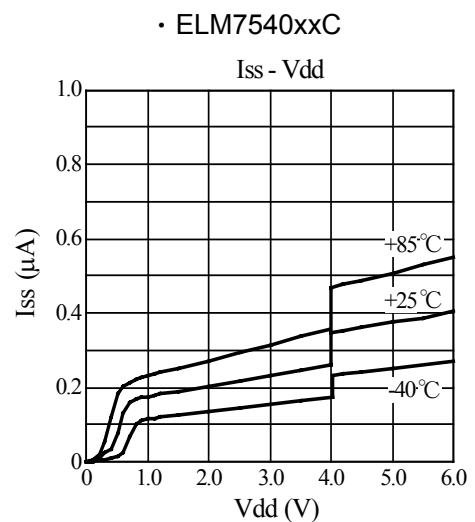
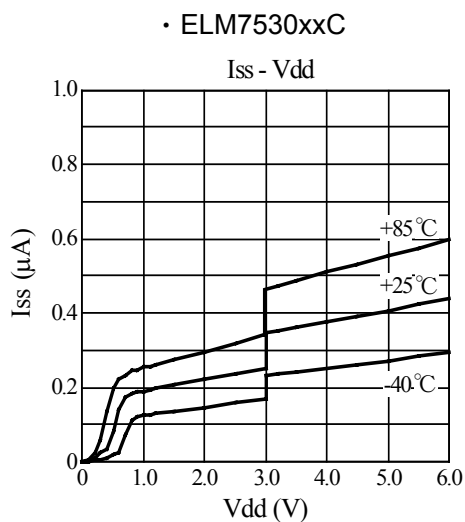
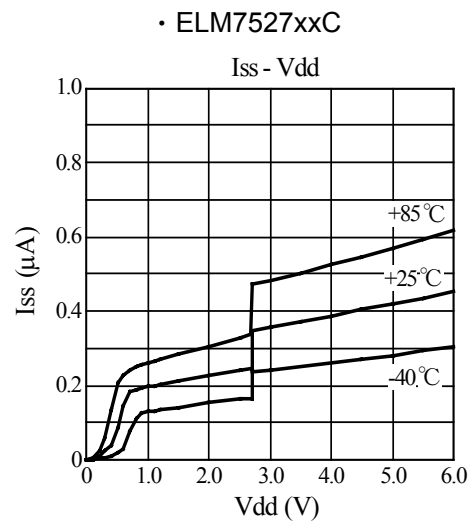
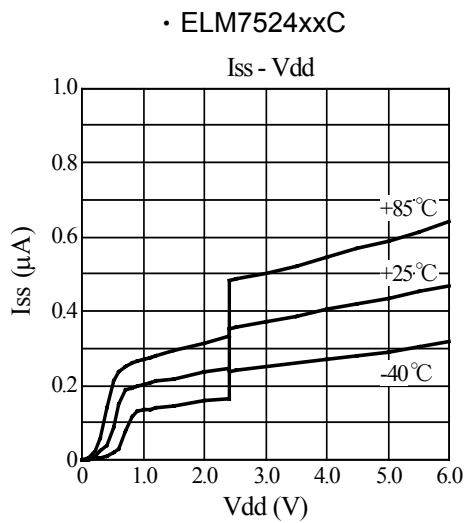
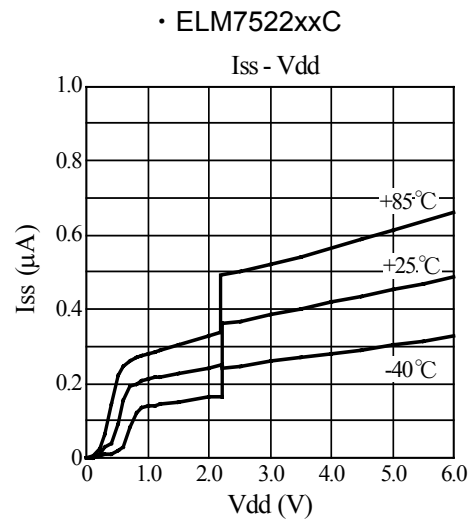
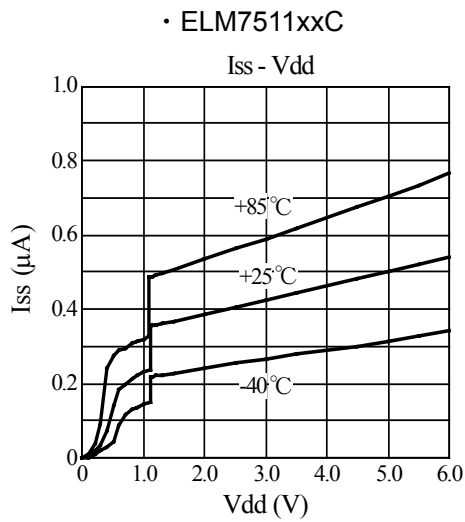

ELM75xxxxC CMOS Small package voltage detector

<http://www.elm-tech.com>

■ Detection voltage characteristics

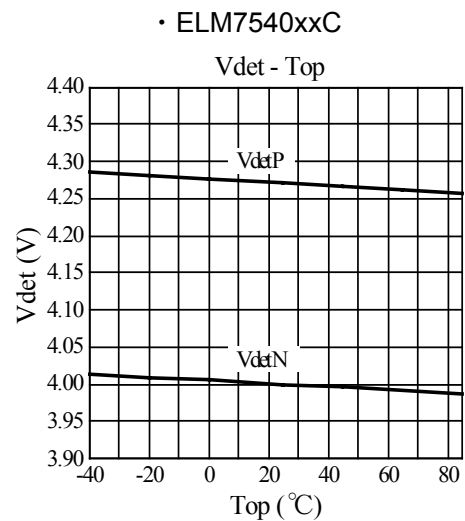
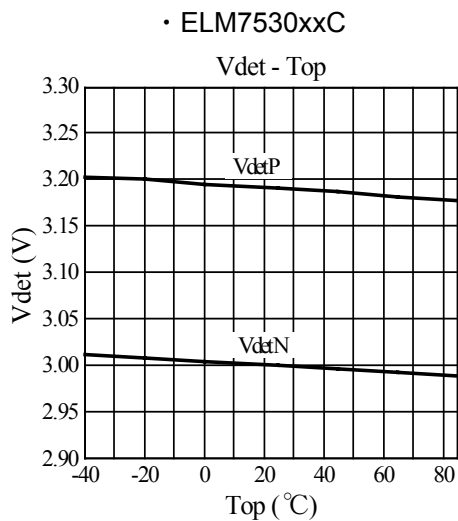
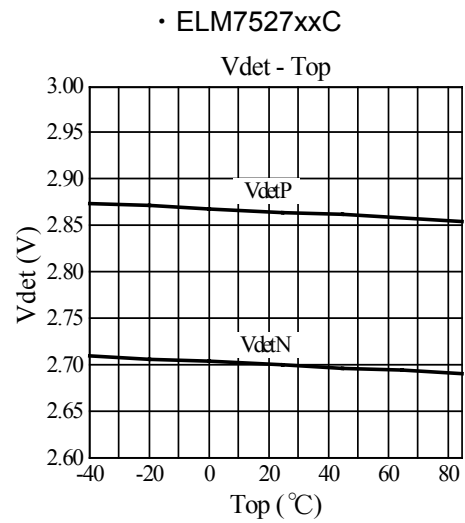
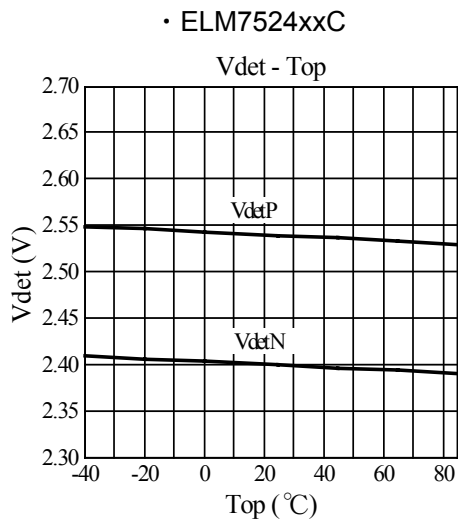
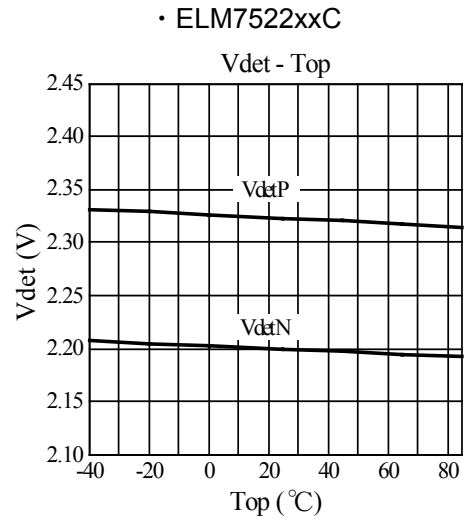
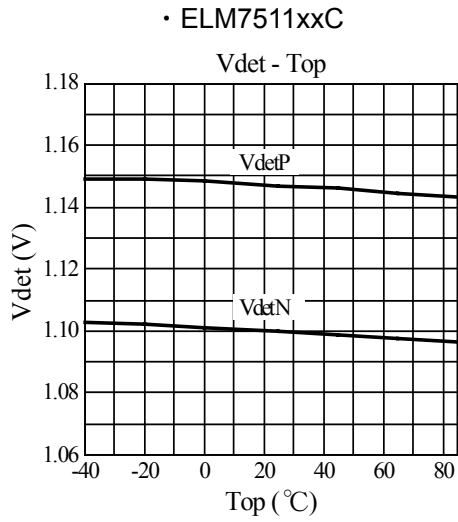

ELM75xxxxC CMOS Small package voltage detector

<http://www.elm-tech.com>

■ Output voltage characteristics

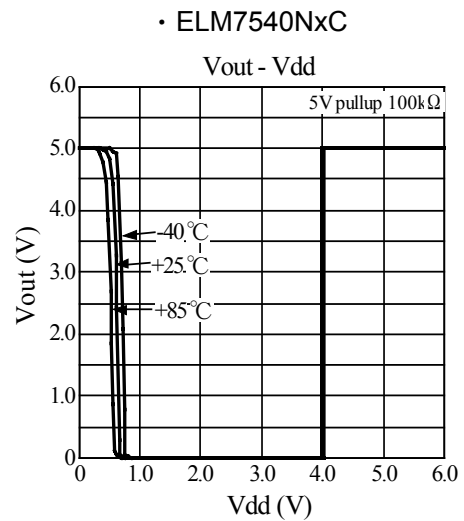
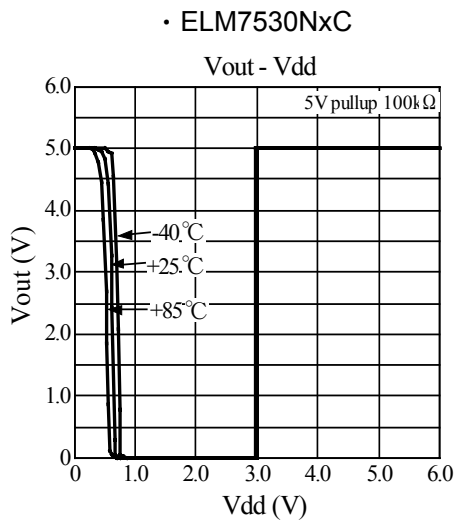
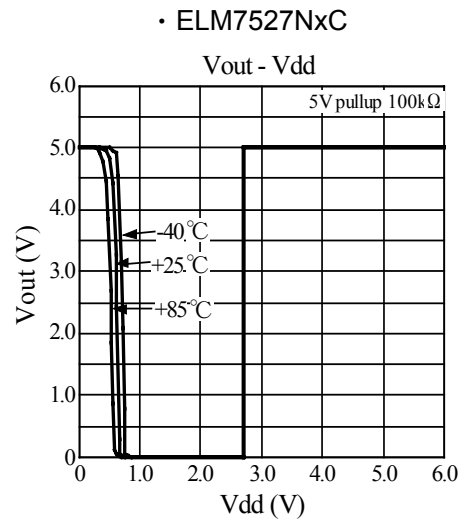
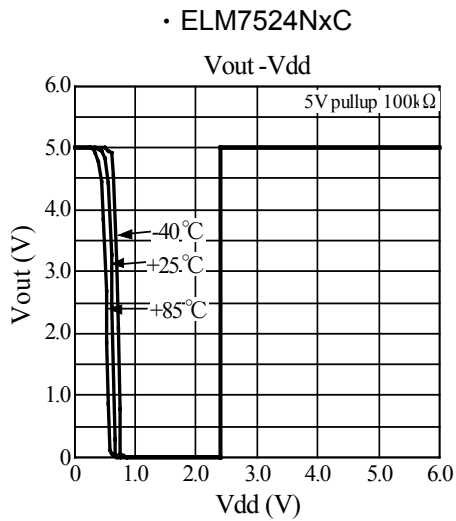
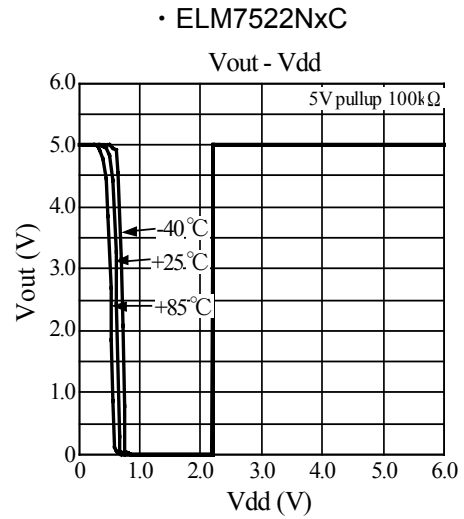
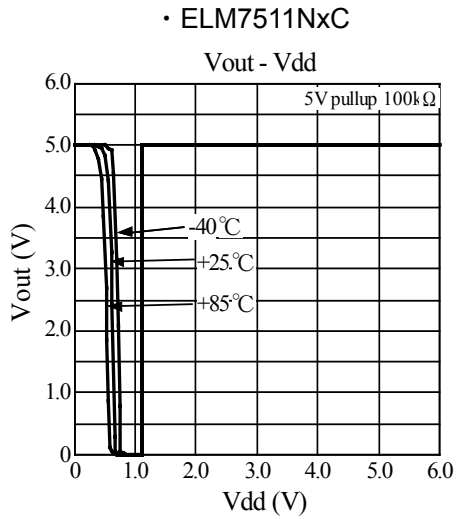

ELM75xxxxC CMOS Small package voltage detector

<http://www.elm-tech.com>

■ Output current characteristics

• ELM75xxxxC

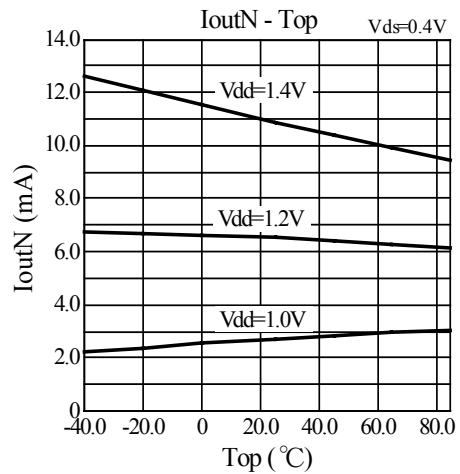
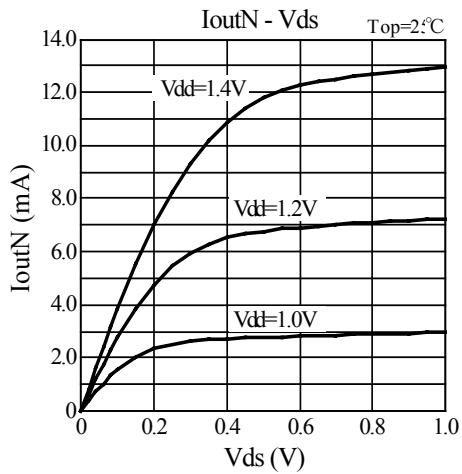
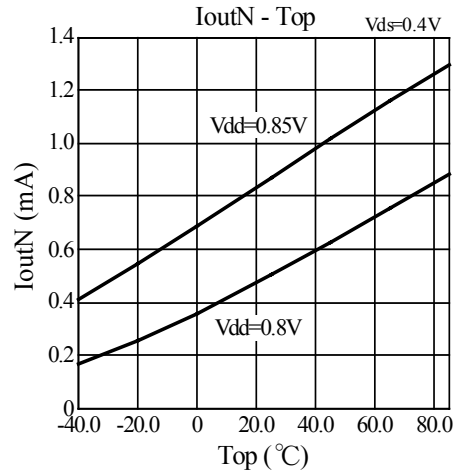
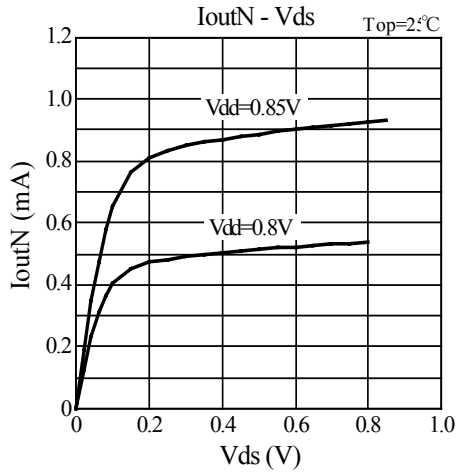

• ELM75xxCx

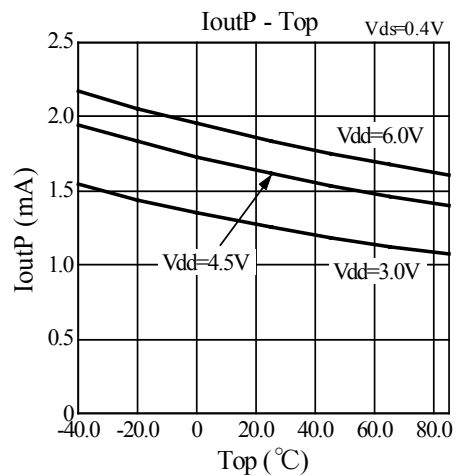
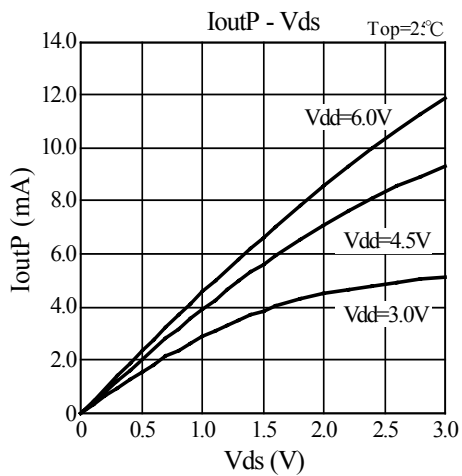

ELM75xxxxC CMOS Small package voltage detector

<http://www.elm-tech.com>

■ Delay time characteristics

- ELM7511xxC

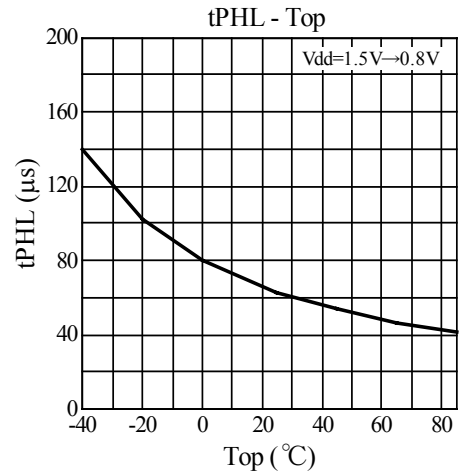
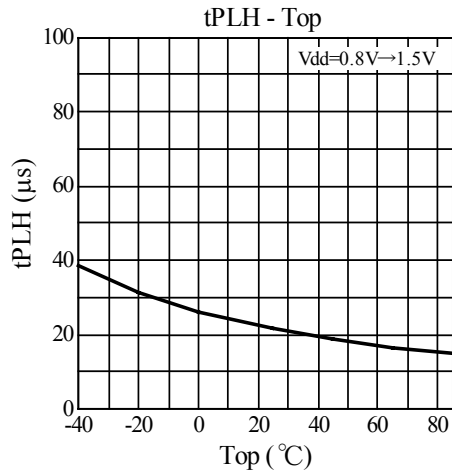

- ELM7522xxC, ELM7524xxC

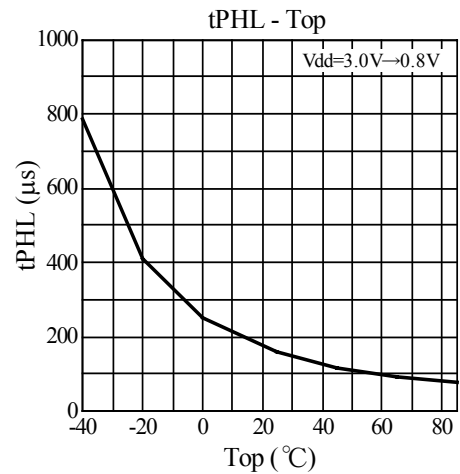
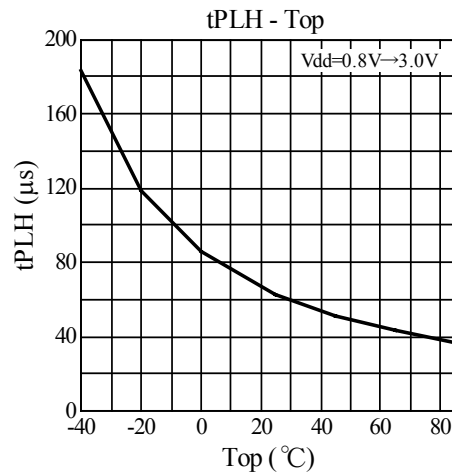

- ELM7527xxC, ELM7530xxC, ELM7540xxC

