

ELM92xxxx CMOS 600kHz High output current PWM step-up DC/DC converter

http://www.elm-tech.com

■General description

ELM92xxxx is CMOS PWM step-up DC/DC converter which consists of reference voltage source, error amplifier, oscillation circuit, start-up circuit, output voltage setting resistor, LX transistor and switching current limiter. For external parts, coil, diode and capacitor are possible choices; with external parts, ELM92 series is able to acquire constant output voltage higher than input voltage. The standard output voltages are 2.7V, 3.0V, 3.3V, and 5.0V; ELM92 series can also be designed as semi-custom IC within the range of 2.5V to 5.5V by 0.1V step. Meanwhile, 600kHz high frequency PWM control scheme makes it easy to design DC/DC converter which can generate large output current with high stability and small ripples by only using small external inductor. With newly developed intermittent operation control scheme, ELM92 series is able to work with high efficiency under wide range of load conditions.

■Features

- Output voltage range : 2.5V to 5.5V (by 0.1V)
- Low voltage operation : $V_{in} \geq 0.9V$
- Oscillating frequency : Typ.600kHz
- Output current(e.g.) : 250mA($V_{in}=1.5V, V_{out}=3.0V$)
- CE(Chip-enable pin) available
: Max.0.5 μ A(ELM92xx2x Iss at shutdown)
- High efficiency : Typ.85%
- Switching current limiter
- Package : SOT-89, SOT-89-5

■Application

- Constant voltage source for battery-operated devices
- Constant voltage source for PDAs, cameras, portable communications equipments and videos
- Local regulator

■Maximum absolute ratings

Parameter	Symbol	Limit	Unit
Apply voltage to LX pin	Vlx	Vss-0.3 to 8.0	V
Apply voltage to VOUT pin	Vout	Vss-0.3 to 8.0	V
Apply voltage to CE pin	Vce	Vss-0.3 to 8.0	V
Power dissipation	Pd	500 (SOT-89)	mW
		500 (SOT-89-5)	
Operating temperature	Top	-40 to +85	°C
Storage temperature	Tstg	-55 to +125	°C

■Selection guide

ELM92xxxx-x

Symbol		
a, b	Output voltage	e.g. : 27: Vout=2.7V 30: Vout=3.0V 33: Vout=3.3V 50: Vout=5.0V
c	CE selection	1: No CE type (SOT-89) 2: CE type (SOT-89-5)
d	Package	B: SOT-89, SOT-89-5
e	Taping direction	S: Refer to PKG file N: Refer to PKG file

ELM92 x x x x - x
 ↑ ↑ ↑ ↑ ↑
 a b c d e

ELM92xxxx CMOS 600kHz High output current PWM step-up DC/DC converter

<http://www.elm-tech.com>

■ Pin configuration

SOT-89(TOP VIEW)

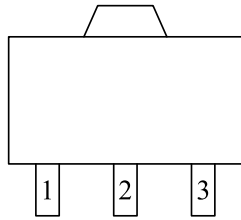

Pin No.	Pin name
1	VOUT
2	VSS
3	LX

SOT-89-5(TOP VIEW)

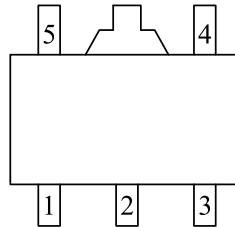

Pin No.	Pin name
1	VOUT
2	VSS
3	LX
4	NC
5	CE ("H"=active, "L"=shutdown)

■ Standard circuit

- ELM92xx1x

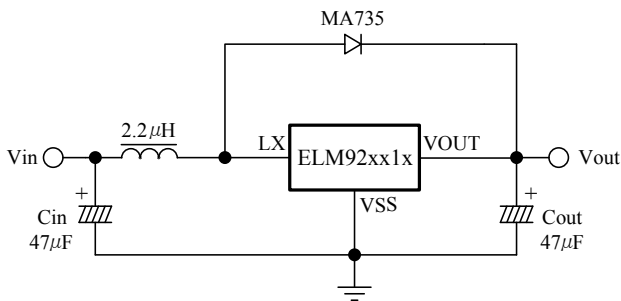

- ELM92xx2x

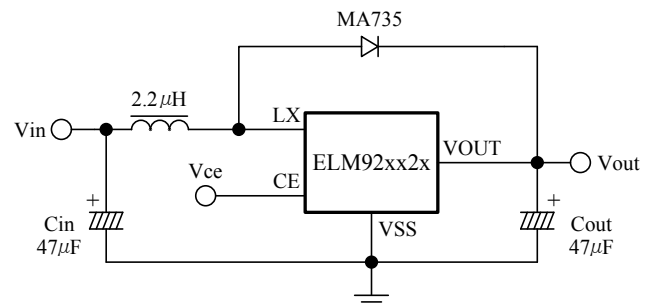

■ Block diagram

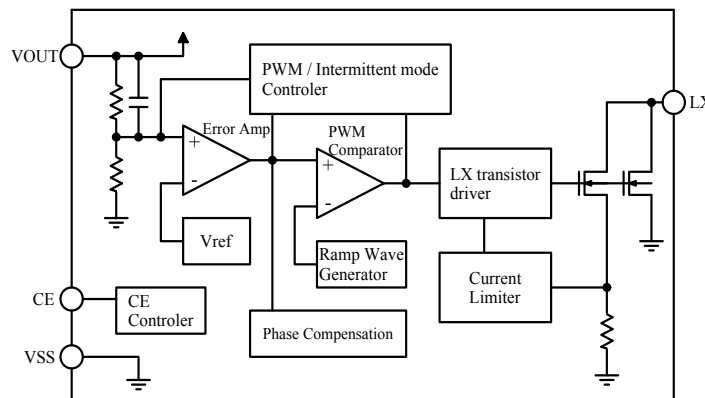

ELM92xxxx CMOS 600kHz High output current PWM step-up DC/DC converter

<http://www.elm-tech.com>

■Electrical characteristics (ELM92xx1x)

Vout=2.7V(ELM92271x)

L=2.2μH, Cout=47μF, D=MA735, Vss=0V, Top=25°C

Parameter	Symbol	Condition	Min.	Typ.	Max.	Unit	Note
Input voltage	Vin				7	V	
Starting voltage	Vst	No-load			0.9	V	1
Output voltage1	Vout1	Iout=60mA, Vin=1.5V	2.633	2.700	2.767	V	1
Output voltage2	Vout2	Iout=0.1mA, Vin=1.5V	Vout1 ×1.005	Vout1 ×1.010	Vout1 ×1.020	V	1
Current consumption1	Iss1	Vout=Vout(T)×0.95		280	450	μA	2
Current consumption2	Iss2	Vout=Vout(T)+0.5V		70	110	μA	2
Oscillating frequency	Fosc	Vout=Vout(T)×0.95	510	600	690	kHz	3
Duty ratio	Duty	Vout=Vout(T)×0.95	80	88	95	%	3
Frequency of intermittent control	Fimt			12	17	kHz	3
On-resistance of LX switch	Ron	Vout=Vout(T)×0.95		270	370	mΩ	4
Leakage current of LX switch	Ilx1	Vout=Vlx=7V			1	μA	5

* Vout: input voltage to VOUT pin

* Vout(T): typical value of Vout1

* Remarks: test circuit No

Vout=3.0V(ELM92301x)

L=2.2μH, Cout=47μF, D=MA735, Vss=0V, Top=25°C

Parameter	Symbol	Condition	Min.	Typ.	Max.	Unit	Note
Input voltage	Vin				7	V	
Starting voltage	Vst	No-load			0.9	V	1
Output voltage1	Vout1	Iout=60mA, Vin=1.5V	2.925	3.000	3.075	V	1
Output voltage2	Vout2	Iout=0.1mA, Vin=1.5V	Vout1 ×1.005	Vout1 ×1.010	Vout1 ×1.020	V	1
Current consumption1	Iss1	Vout=Vout(T)×0.95		300	480	μA	2
Current consumption2	Iss2	Vout=Vout(T)+0.5V		75	120	μA	2
Oscillating frequency	Fosc	Vout=Vout(T)×0.95	510	600	690	kHz	3
Duty ratio	Duty	Vout=Vout(T)×0.95	80	88	95	%	3
Frequency of intermittent control	Fimt			12	17	kHz	3
On-resistance of LX switch	Ron	Vout=Vout(T)×0.95		250	340	mΩ	4
Leakage current of LX switch	Ilx1	Vout=Vlx=7V			1	μA	5

* Vout: input voltage to VOUT pin

* Vout(T): typical value of Vout1

* Remarks: test circuit No

ELM92xxxx CMOS 600kHz High output current PWM step-up DC/DC converter

<http://www.elm-tech.com>

Vout=3.3V(ELM92331x)

L=2.2μH, Cout=47μF, D=MA735, Vss=0V, Top=25°C

Parameter	Symbol	Condition	Min.	Typ.	Max.	Unit	Note
Input voltage	Vin				7	V	
Starting voltage	Vst	No-load			0.9	V	1
Output voltage1	Vout1	Iout=60mA, Vin=1.5V	3.218	3.300	3.382	V	1
Output voltage2	Vout2	Iout=0.1mA, Vin=1.5V	Vout1 ×1.005	Vout1 ×1.010	Vout1 ×1.020	V	1
Current consumption1	Iss1	Vout=Vout(T)×0.95		320	510	μA	2
Current consumption2	Iss2	Vout=Vout(T)+0.5V		80	130	μA	2
Oscillating frequency	Fosc	Vout=Vout(T)×0.95	510	600	690	kHz	3
Duty ratio	Duty	Vout=Vout(T)×0.95	80	88	95	%	3
Frequency of intermittent control	Fimt			12	17	kHz	3
On-resistance of LX switch	Ron	Vout=Vout(T)×0.95		245	330	mΩ	4
Leakage current of LX switch	Ilx1	Vout=Vlx=7V			1	μA	5

* Vout: input voltage to VOUT pin

* Vout(T): typical value of Vout1

* Remarks: test circuit No

Vout=5.0V(ELM92501x)

L=2.2μH, Cout=47μF, D=MA735, Vss=0V, Top=25°C

Parameter	Symbol	Condition	Min.	Typ.	Max.	Unit	Note
Input voltage	Vin				7	V	
Starting voltage	Vst	No-load			0.9	V	1
Output voltage1	Vout1	Iout=60mA, Vin=3V	4.875	5.000	5.125	V	1
Output voltage2	Vout2	Iout=0.1mA, Vin=3V	Vout1 ×1.005	Vout1 ×1.010	Vout1 ×1.020	V	1
Current consumption1	Iss1	Vout=Vout(T)×0.95		550	880	μA	2
Current consumption2	Iss2	Vout=Vout(T)+0.5V		90	145	μA	2
Oscillating frequency	Fosc	Vout=Vout(T)×0.95	510	600	690	kHz	3
Duty ratio	Duty	Vout=Vout(T)×0.95	80	88	95	%	3
Frequency of intermittent control	Fimt			12	17	kHz	3
On-resistance of LX switch	Ron	Vout=Vout(T)×0.95		220	300	mΩ	4
Leakage current of LX switch	Ilx1	Vout=Vlx=7V			1	μA	5

* Vout: input voltage to VOUT pin

* Vout(T): typical value of Vout1

* Remarks: test circuit No

ELM92xxxx CMOS 600kHz High output current PWM step-up DC/DC converter

<http://www.elm-tech.com>

■Electrical characteristics (ELM92xx2x)

Vout=2.7V(ELM92272x)

Vce=Vout, L=2.2μH, Cout=47μF, D=MA735, Vss=0V, Top=25°C

Parameter	Symbol	Condition	Min.	Typ.	Max.	Unit	Note
Input voltage	Vin				7	V	
Starting voltage	Vst	No-load			0.9	V	1
Output voltage1	Vout1	Iout=60mA, Vin=1.5V	2.633	2.700	2.767	V	1
Output voltage2	Vout2	Iout=0.1mA, Vin=1.5V	Vout1 ×1.005	Vout1 ×1.010	Vout1 ×1.020	V	1
Current consumption1	Iss1	Vout=Vout(T)×0.95		280	450	μA	2
Current consumption2	Iss2	Vout=Vout(T)+0.5V		70	110	μA	2
Current consumption in Shutdown	Isd	Vout=Vout(T)×0.95, Vce=0			0.5	μA	2
Oscillating frequency	Fosc	Vout=Vout(T)×0.95	510	600	690	kHz	3
Duty ratio	Duty	Vout=Vout(T)×0.95	80	88	95	%	3
Frequency of Intermittent control	Fimt			12	17	kHz	3
On-resistance of LX switch	Ron	Vout=Vout(T)×0.95		270	370	mΩ	4
Leakage current of LX switch	Ilxl	Vout=Vlx=7V			1	μA	5
CE Input voltage "H"	Vceh		0.8			V	6
CE Input voltage "L"	Vcel				0.25	V	6
CE Input current "H"	Iceh	Vout=Vout(T)×0.95, Vce=Vout(T)×0.95			0.1	μA	6
CE Input current "L"	Icel	Vout=Vout(T)×0.95, Vce=0			-0.1	μA	6

* 1.Vout: input voltage to VOUT pin. 2.Vout(T): typical value of Vout1. 3.Vce: input voltage to CE pin. 4.Remarks: test circuit No

Vout=3.0V(ELM92302x)

Vce=Vout, L=2.2μH, Cout=47μF, D=MA735, Vss=0V, Top=25°C

Parameter	Symbol	Condition	Min.	Typ.	Max.	Unit	Note
Input voltage	Vin				7	V	
Starting voltage	Vst	No-load			0.9	V	1
Output voltage1	Vout1	Iout=60mA, Vin=1.5V	2.925	3.000	3.075	V	1
Output voltage2	Vout2	Iout=0.1mA, Vin=1.5V	Vout1 ×1.005	Vout1 ×1.010	Vout1 ×1.020	V	1
Current consumption1	Iss1	Vout=Vout(T)×0.95		300	480	μA	2
Current consumption2	Iss2	Vout=Vout(T)+0.5V		75	120	μA	2
Current consumption in Shutdown	Isd	Vout=Vout(T)×0.95, Vce=0			0.5	μA	2
Oscillating frequency	Fosc	Vout=Vout(T)×0.95	510	600	690	kHz	3
Duty ratio	Duty	Vout=Vout(T)×0.95	80	88	95	%	3
Frequency of Intermittent control	Fimt			12	17	kHz	3
On-resistance of LX switch	Ron	Vout=Vout(T)×0.95		250	340	mΩ	4
Leakage current of LX switch	Ilxl	Vout=Vlx=7V			1	μA	5
CE Input voltage "H"	Vceh		0.8			V	6
CE Input voltage "L"	Vcel				0.25	V	6
CE Input current "H"	Iceh	Vout=Vout(T)×0.95, Vce=Vout(T)×0.95			0.1	μA	6
CE Input current "L"	Icel	Vout=Vout(T)×0.95, Vce=0			-0.1	μA	6

* 1.Vout: input voltage to VOUT pin. 2.Vout(T): typical value of Vout1. 3.Vce: input voltage to CE pin. 4.Remarks: test circuit No

ELM92xxxx CMOS 600kHz High output current PWM step-up DC/DC converter

<http://www.elm-tech.com>

Vout=3.3V(ELM92332x)

Vce=Vout, L=2.2μH, Cout=47μF, D=MA735, Vss=0V, Top=25°C

Parameter	Symbol	Condition	Min.	Typ.	Max.	Unit	Note
Input voltage	Vin				7	V	
Starting voltage	Vst	No-load			0.9	V	1
Output voltage1	Vout1	Iout=60mA, Vin=1.5V	3.218	3.300	3.382	V	1
Output voltage2	Vout2	Iout=0.1mA, Vin=1.5V	Vout1 ×1.005	Vout1 ×1.010	Vout1 ×1.020	V	1
Current consumption1	Iss1	Vout=Vout(T)×0.95		320	510	μA	2
Current consumption2	Iss2	Vout=Vout(T)+0.5V		80	130	μA	2
Current consumption in Shutdown	Isd	Vout=Vout(T)×0.95, Vce=0			0.5	μA	2
Oscillating frequency	Fosc	Vout=Vout(T)×0.95	510	600	690	kHz	3
Duty ratio	Duty	Vout=Vout(T)×0.95	80	88	95	%	3
Frequency of Intermittent control	Fimt			12	17	kHz	3
On-resistance of LX switch	Ron	Vout=Vout(T)×0.95		245	330	mΩ	4
Leakage current of LX switch	Ilxl	Vout=Vlx=7V			1	μA	5
CE Input voltage "H"	Vceh		0.8			V	6
CE Input voltage "L"	Vcel				0.25	V	6
CE Input current "H"	Iceh	Vout=Vout(T)×0.95, Vce=Vout(T)×0.95			0.1	μA	6
CE Input current "L"	Icel	Vout=Vout(T)×0.95, Vce=0			-0.1	μA	6

* 1.Vout: input voltage to VOUT pin. 2.Vout(T): typical value of Vout1. 3.Vce: input voltage to CE pin. 4.Remarks: test circuit No

Vout=5.0V(ELM92502x)

Vce=Vout, L=2.2μH, Cout=47μF, D=MA735, Vss=0V, Top=25°C

Parameter	Symbol	Condition	Min.	Typ.	Max.	Unit	Note
Input voltage	Vin				7	V	
Starting voltage	Vst	No-load			0.9	V	1
Output voltage1	Vout1	Iout=60mA, Vin=3V	4.875	5.000	5.125	V	1
Output voltage2	Vout2	Iout=0.1mA, Vin=3V	Vout1 ×1.005	Vout1 ×1.010	Vout1 ×1.020	V	1
Current consumption1	Iss1	Vout=Vout(T)×0.95		550	880	μA	2
Current consumption2	Iss2	Vout=Vout(T)+0.5V		90	145	μA	2
Current consumption in Shutdown	Isd	Vout=Vout(T)×0.95, Vce=0			0.5	μA	2
Oscillating frequency	Fosc	Vout=Vout(T)×0.95	510	600	690	kHz	3
Duty ratio	Duty	Vout=Vout(T)×0.95	80	88	95	%	3
Frequency of Intermittent control	Fimt			12	17	kHz	3
On-resistance of LX switch	Ron	Vout=Vout(T)×0.95		220	300	mΩ	4
Leakage current of LX switch	Ilxl	Vout=Vlx=7V			1	μA	5
CE Input voltage "H"	Vceh		0.8			V	6
CE Input voltage "L"	Vcel				0.25	V	6
CE Input current "H"	Iceh	Vout=Vout(T)×0.95, Vce=Vout(T)×0.95			0.1	μA	6
CE Input current "L"	Icel	Vout=Vout(T)×0.95, Vce=0			-0.1	μA	6

* 1.Vout: input voltage to VOUT pin. 2.Vout(T): typical value of Vout1. 3.Vce: input voltage to CE pin. 4.Remarks: test circuit No

ELM92xxxx CMOS 600kHz High output current PWM step-up DC/DC converter

<http://www.elm-tech.com>

■ Test circuits

1. Vout1, Vout2, Vst

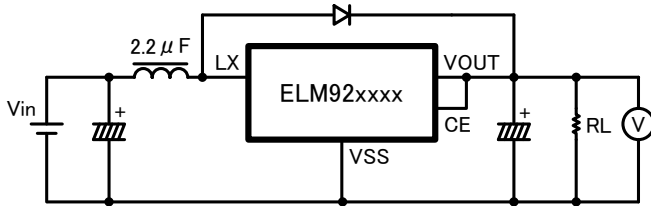

2. Iss1, Iss2, Isd

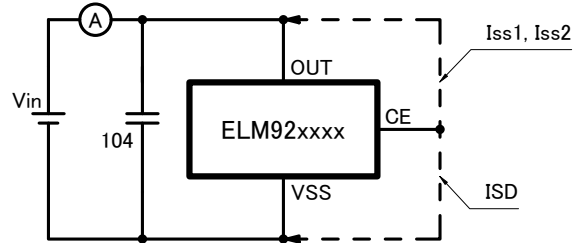

3. Fosc, Duty, Fimt (LX pin)

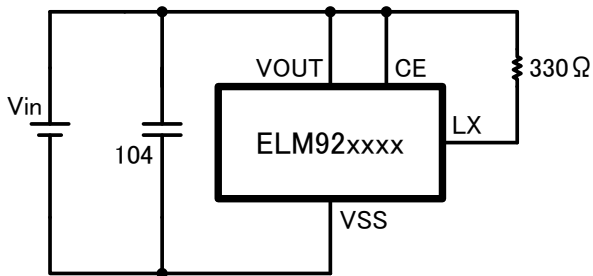

* Fosc, Duty : $V_{in} = V_{out}(T) \times 0.95$
 * Fimt : $V_{in} = V_{out}1(1.005 \text{ to } 1.020)$

4. RON

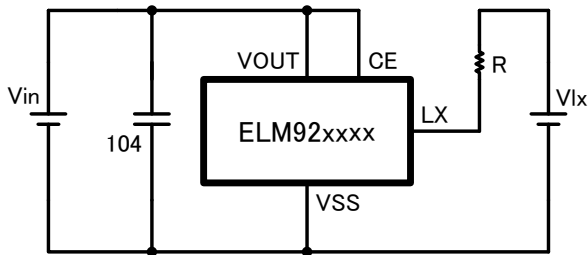

* $V_{lx} = 3V, R = 30\Omega$
 * $R_{on} = \frac{R \cdot V_{on}}{V_{lx} - V_{on}} \Omega$

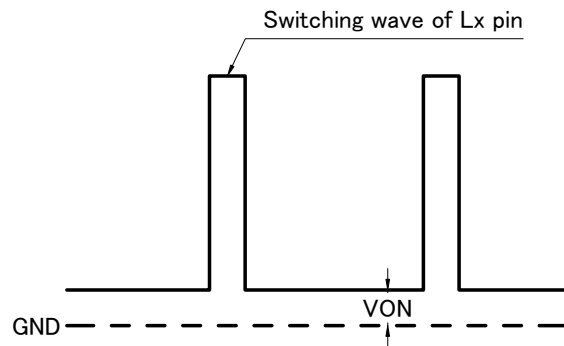

5. I_{lx}

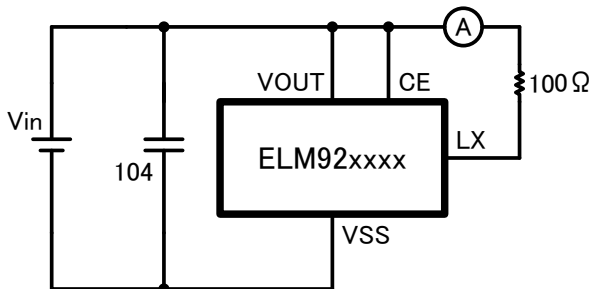

6. V_{ceh}, V_{cel}, I_{ceh}, I_{cel}

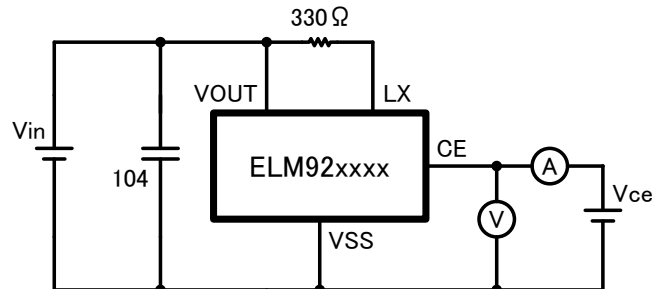

Remarks) CE pin : ELM92xx2x series

ELM92xxxx CMOS 600kHz High output current PWM step-up DC/DC converter

<http://www.elm-tech.com>

External parts

To design DC/DC converters using ELM92 series, coil, diode, and capacitor are necessary.
(Refer to the standard circuit configuration.)

1) Coil

When choosing choke coil, please select that whose core is not magnetically saturated, DC resistance is low, and which has sufficient margin for rated current.

ELM recommends to use inductance around $2.2\mu\text{H}$. It is possible that output voltage ripple form may reach over 10mV when using high inductance. If ripple can be ignored, it is possible to acquire high efficiency with high inductance.

The examples using $4.7\mu\text{H}$ are shown as follows.

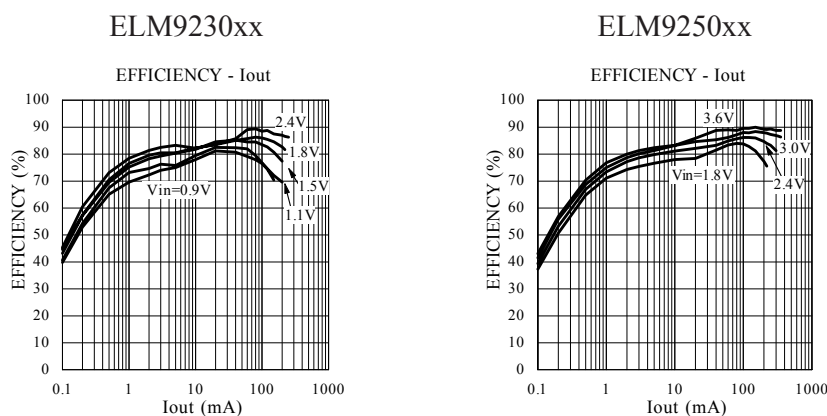

* CR43/CD43/CR54/CD54 : Sumida Electric Co., Ltd are recommended.

2) Diode

When choosing diode, please select that whose forward voltage is small, switching speed is high and which has sufficient margin for rated current.

ELM recommends diode which is around 1A class.

3) Capacitor

* Cout

When choosing capacitor, please select that which is generally used for smoothing power supply circuit, with comparatively large capacity and whose rated voltage is at least three times larger than rated output voltage of used ELM92 series. ELM recommends capacitor which is $47\mu\text{F}$ to $220\mu\text{F}$. When V_{in} is high ($V_{in} > V_{out} \times 0.7$), it is possible that large ripple of I_{out} may happen because of intermittent operation; ELM recommends to use larger capacitor under such circumstance.

* Cin

Using C_{in} in the circuit can lower feedback noise to Input; this method is also effective in improving efficiency because input voltage drop during switching can be eased. To gain this effect, please connect tantalum capacitor of $47\mu\text{F}$ to $220\mu\text{F}$ to coil as close as possible.

ELM92xxxx CMOS 600kHz High output current PWM step-up DC/DC converter

4) Remedies for noise

This DC/DC converter may cause electromagnetic noise due to switching of coil under large current. Solution is necessary especially when the IC is used in wireless devices.

To reduce noise, this IC is designed in consideration of coil switching characteristics. The following methods are also effective to reduce noise.

- Use shield-type, or magnetic shield coil.
- Locate coil and diode to the LX terminal of IC as close as possible.
- Select ground wire as thick and short as possible.
- Connect ground wire of circuit to one point.

■Marking

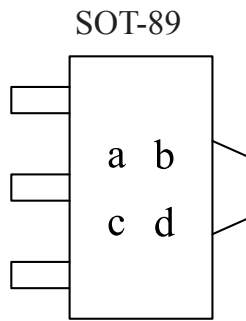

- SOT-89 package : ELM92xx1B
- SOT-89-5 package : ELM92xx2B(with CE)

a : Assembly lot No. ——
B to Z (I, O, X excepted)

b : Assembly lot No. ——
A to Z (I, O, X excepted)

c : the integer digit of the output voltage

Mark	Vout	Mark	Vout
2	2.*V	4	4.*V
3	3.*V	5	5.*V

d : the decimal digit of the output voltage

Mark	Vout	Mark	Vout
0	*.0V	5	*.5V
1	*.1V	6	*.6V
2	*.2V	7	*.7V
3	*.3V	8	*.8V
4	*.4V	9	*.9V

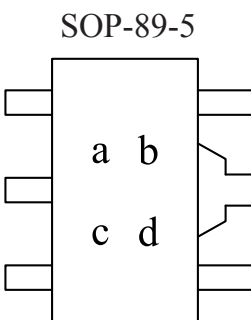

ELM92xxxx CMOS 600kHz High output current PWM step-up DC/DC converter

<http://www.elm-tech.com>

■ Typical characteristics

- $V_{out}=2.7V$ (ELM9227xx) ($L=2.2\mu H$, $C_{out}=47\mu F$, $D=MA735$, $T_{op}=25^{\circ}C$)

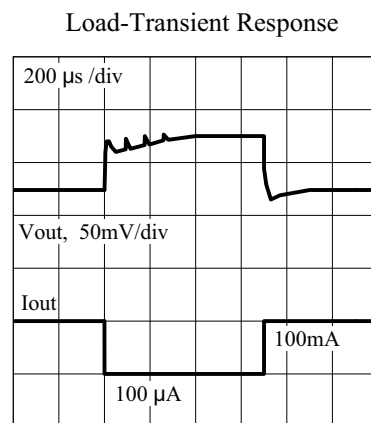
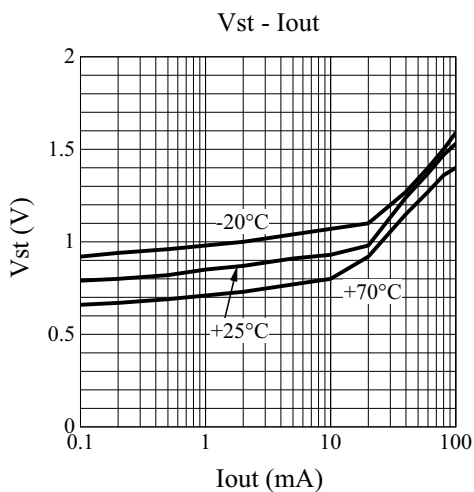
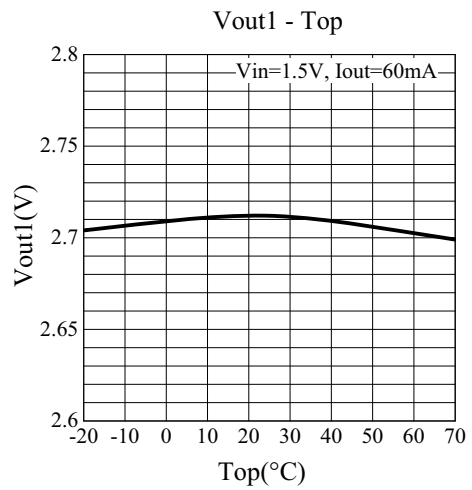
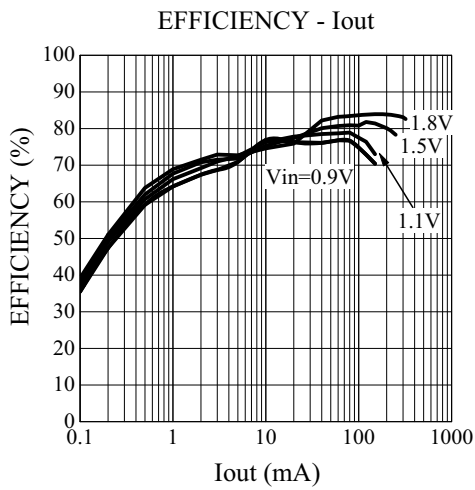
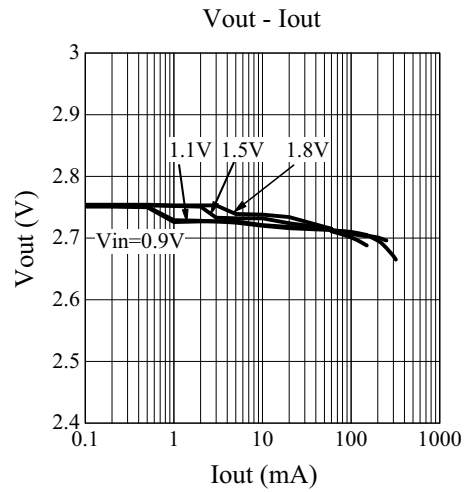
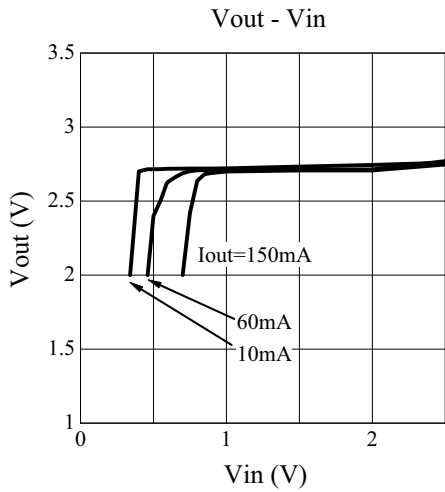

ELM92xxxx CMOS 600kHz High output current PWM step-up DC/DC converter

<http://www.elm-tech.com>

- $V_{out}=3.0V$ (ELM9230xx) ($L=2.2\mu H$, $C_{out}=47\mu F$, $D=MA735$, $T_{op}=25^{\circ}C$)

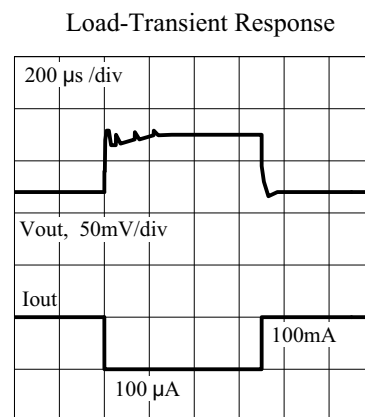
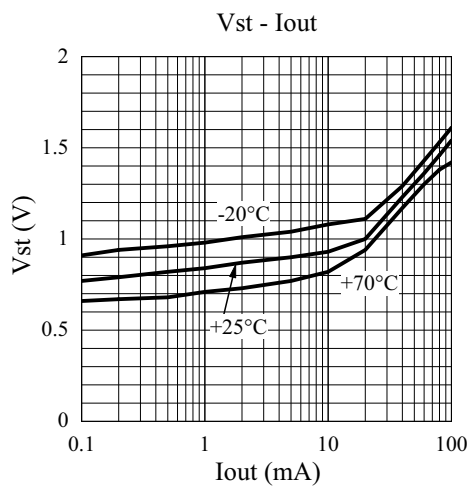
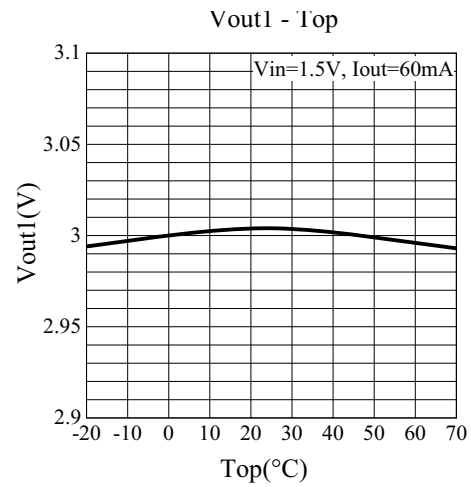
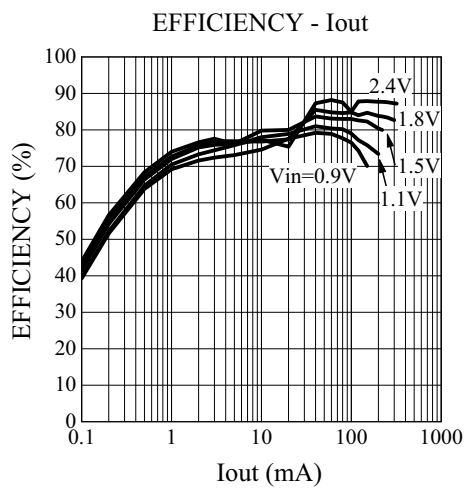
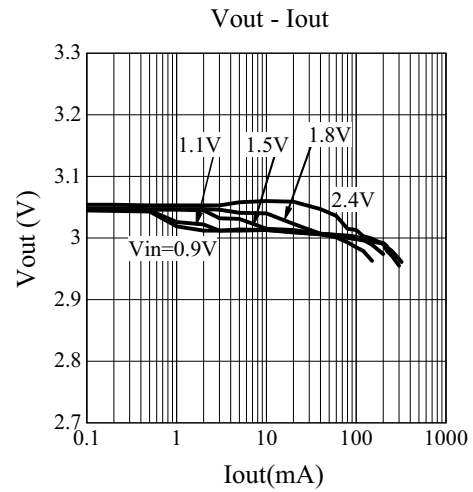
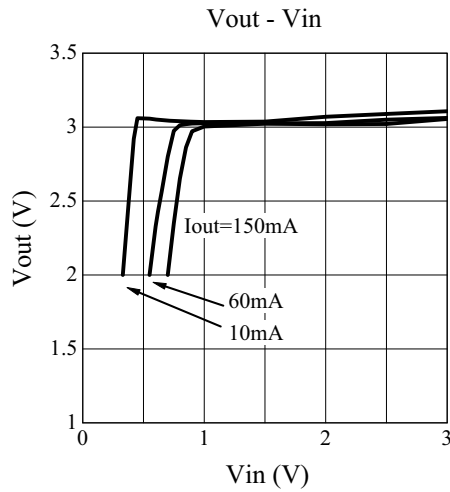

ELM92xxxx CMOS 600kHz High output current PWM step-up DC/DC converter

<http://www.elm-tech.com>

- $V_{out}=3.3V$ (ELM9233xx) ($L=2.2\mu H$, $C_{out}=47\mu F$, $D=MA735$, $T_{op}=25^{\circ}C$)

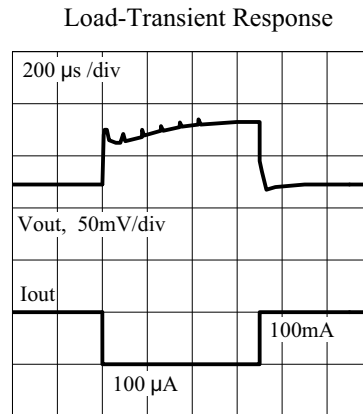
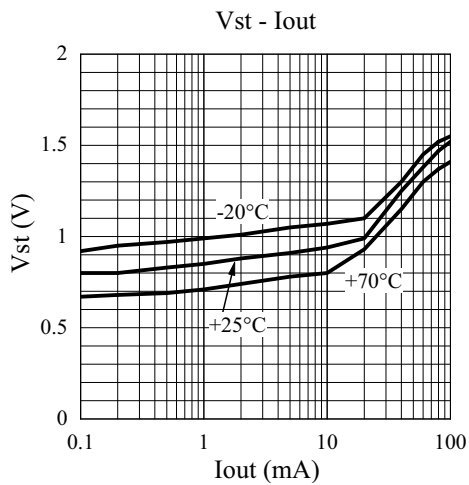
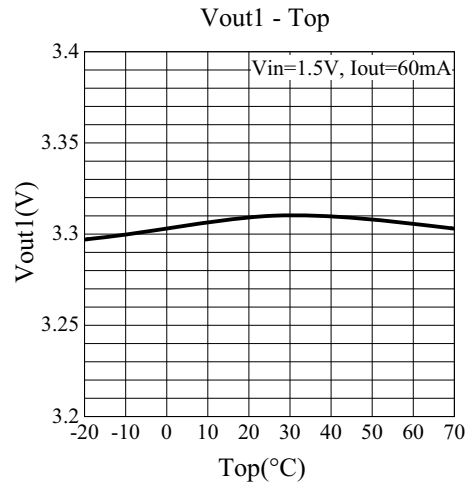
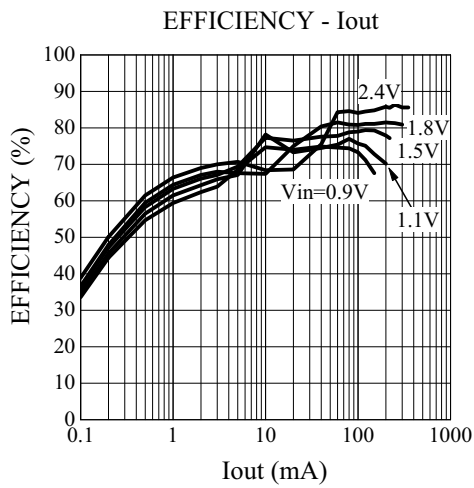
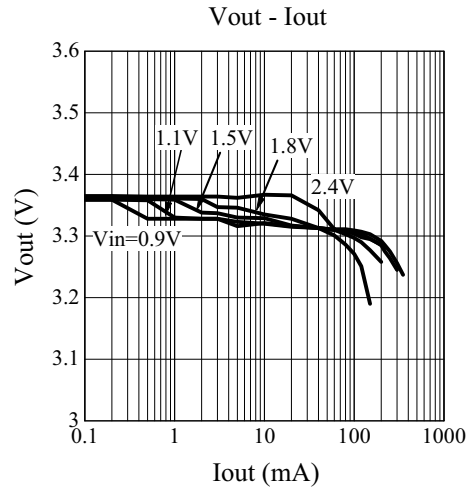
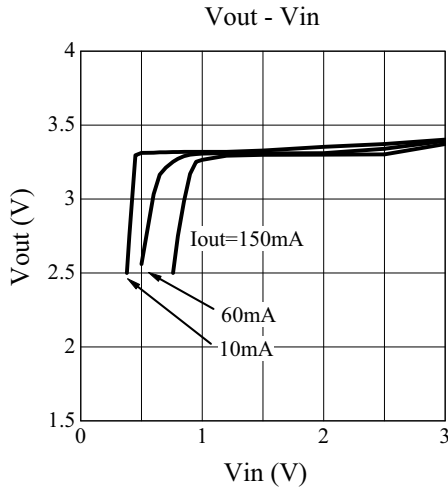

ELM92xxxx CMOS 600kHz High output current PWM step-up DC/DC converter

<http://www.elm-tech.com>

- $V_{out}=5.0V$ (ELM9250xx) ($L=2.2\mu H$, $C_{out}=47\mu F$, $D=MA735$, $T_{op}=25^{\circ}C$)

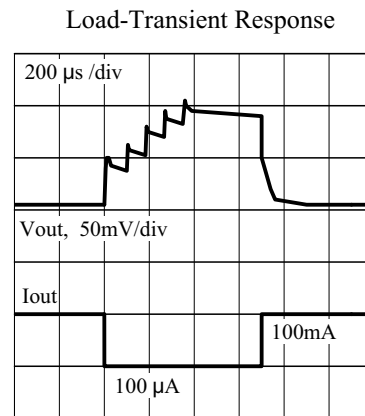
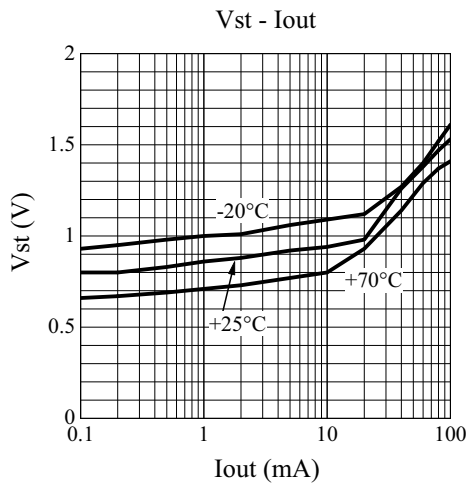
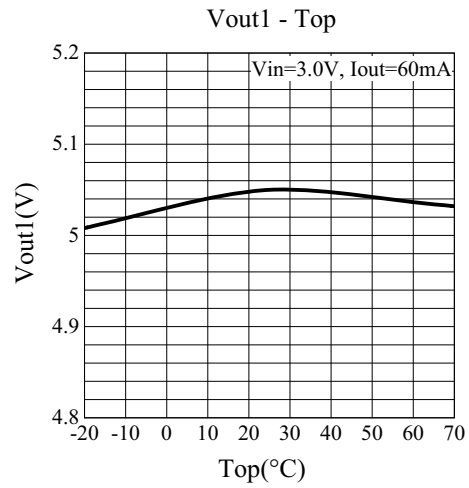
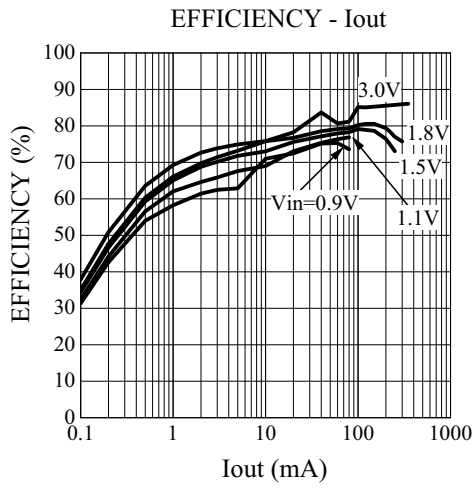
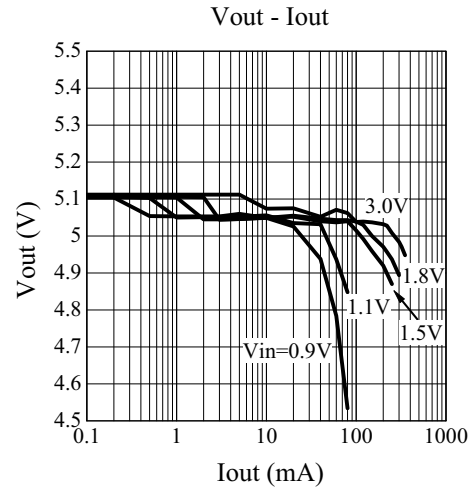
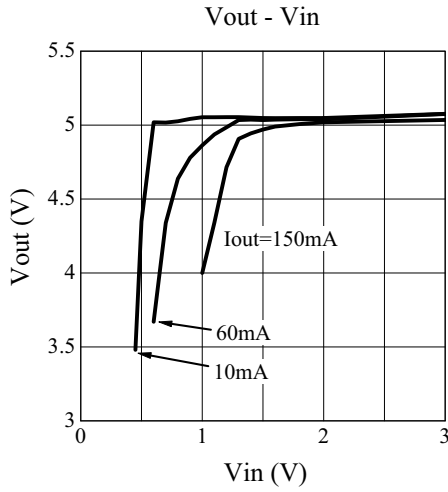

ELM92xxxx CMOS 600kHz High output current PWM step-up DC/DC converter

<http://www.elm-tech.com>

- ELM9227xx, ELM9230xx, ELM9233xx, ELM9250xx
(L=2.2μH, Cout=47μF, D=MA735, Top=25°C)

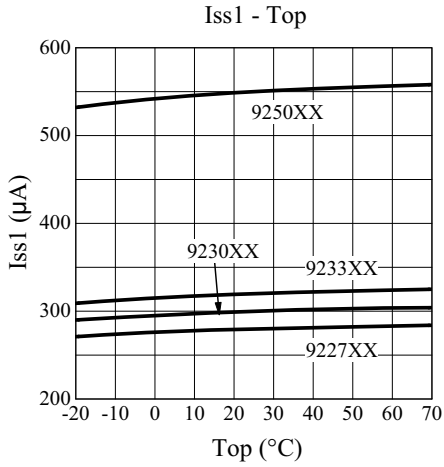

- ELM92xxxx (L=2.2μH, Cout=47μF, D=MA735, Top=25°C)

