

ELM94xxB CMOS PFM step-up DC/DC converter

<http://www.elm-tech.com>

■General description

ELM94xxB is CMOS step-up DC/DC converter which consists of reference voltage source, error amplifier, oscillation circuit, start-up circuit, PFM control circuit, switching transistor and output voltage setting resistor. For external parts, coil, diode and capacitor are possible choices; with external parts, ELM94 series is able to acquire constant output voltage higher than input voltage. The standard output voltages are 2.7V, 3.0V, 3.3V, and 5.0V; ELM94 series can also be designed as semi-custom IC within the range of 2.5V to 5.5V by 0.1V step.

■Features

- Output voltage range : 2.5V to 5.5V (by 0.1V)
- Low voltage operation : $V_{in} \geq 0.98V (R_L = 30k\Omega)$
- Low power operation : Typ. $12\mu W$ (ELM9430B)
- High efficiency : Typ. 80%
- High output voltage accuracy : $\pm 2.5\%$
- Output current(e.g.) : 20mA ($V_{in} = 1.5V, V_{out} = 3.0V$)
- Package : SOT-89

■Application

- Constant voltage source for battery-operated devices
- Constant voltage source for cameras
- Portable communication equipments
- Local regulator

■Maximum absolute ratings

Parameter	Symbol	Limit	Unit
Apply voltage to LX pin	V_{Lx}	12	V
Apply voltage to VOUT pin	V_{out}	12	V
Output current of LX pin	I_{Lx}	200	mA
Power dissipation	P_d	500	mW
Operating temperature	T_{op}	-40 to +85	°C
Storage temperature	T_{stg}	-55 to +125	°C

■Selection guide

ELM94xxB-x

Symbol		
a, b	Output voltage	e.g. : 27: $V_{out} = 2.7V$ 30: $V_{out} = 3.0V$ 33: $V_{out} = 3.3V$ 50: $V_{out} = 5.0V$
c	Product version	B
d	Taping direction	S: Refer to PKG file N: Refer to PKG file

ELM94 x x B - x
 $\begin{matrix} \uparrow & \uparrow & \uparrow & \uparrow \\ a & b & c & d \end{matrix}$

■Pin configuration

SOT-89(TOP VIEW)

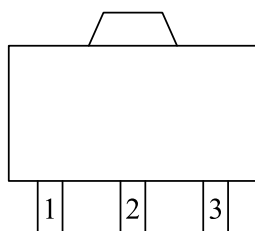

Pin No.	Pin name
1	VSS
2	VOUT
3	LX

ELM94xxB CMOS PFM step-up DC/DC converter

<http://www.elm-tech.com>

■Standard circuit

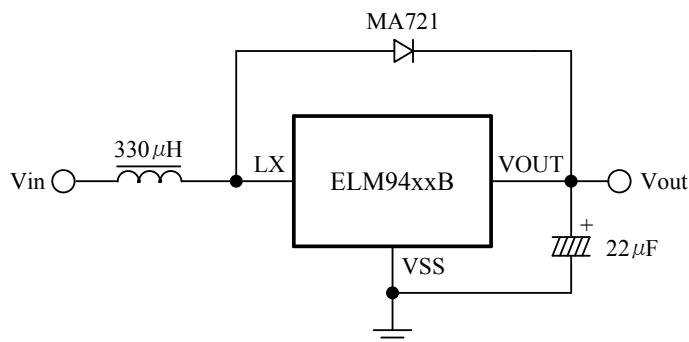

■Block diagram

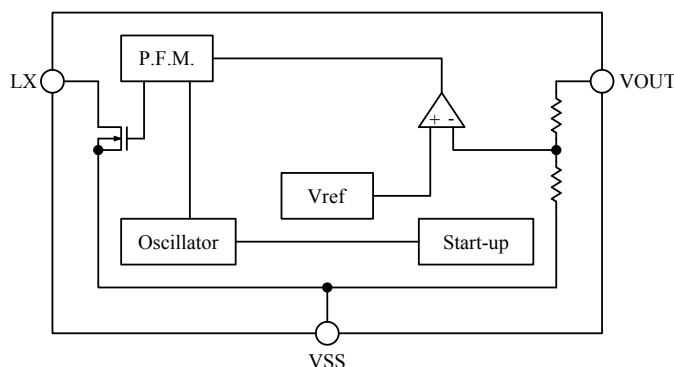

■Electrical characteristics

Vout=2.7V(ELM9427B)

L=330μH, D=MA721, C=22μF, Vss=0V, Top=25°C

Parameter	Symbol	Condition	Min.	Typ.	Max.	Unit
Input voltage	Vin				10	V
Starting voltage	Vst	RL=27kΩ			0.98	V
Holding voltage	Vhold	Iout=1mA			0.7	V
Current consumption	Iss	Iout=100μA, Vin=1.5V		3.5	7.0	μA
Output voltage	Vout	Iout=1mA, Vin=1.5V	2.63	2.70	2.77	V
Output current of LX pin	Ilx	Vout=2.6V, Vlx=0.4V	80			mA
Leakage current of LX pin	Ilxl	Vout=Vlx=10V			1.0	μA
Oscillating frequency	Fosc	Vout=2.6V	22	35	55	kHz
Maximum duty ratio	Duty	Vout=2.6V, Switch"ON"	45	55	65	%

Vout=3.0V(ELM9430B)

L=330μH, D=MA721, C=22μF, Vss=0V, Top=25°C

Parameter	Symbol	Condition	Min.	Typ.	Max.	Unit
Input voltage	Vin				10	V
Starting voltage	Vst	RL=30kΩ			0.98	V
Holding voltage	Vhold	Iout=1mA			0.7	V
Current consumption	Iss	Iout=100μA, Vin=1.5V		4.0	8.0	μA
Output voltage	Vout	Iout=1mA, Vin=1.5V	2.92	3.00	3.08	V
Output current of LX pin	Ilx	Vout=2.9V, Vlx=0.4V	90			mA
Leakage current of LX pin	Ilxl	Vout=Vlx=10V			1.0	μA
Oscillating frequency	Fosc	Vout=2.9V	22	35	55	kHz
Maximum duty ratio	Duty	Vout=2.9V, Switch"ON"	45	55	65	%

ELM94xxB CMOS PFM step-up DC/DC converter

http://www.elm-tech.com

Vout=3.3V(ELM9433B)

L=330μH, D=MA721, C=22μF, Vss=0V, Top=25°C

Parameter	Symbol	Condition	Min.	Typ.	Max.	Unit
Input voltage	Vin				10	V
Starting voltage	Vst	RL=33kΩ			0.98	V
Holding voltage	Vhold	Iout=1mA			0.7	V
Current consumption	Iss	Iout=100μA, Vin=1.5V		4.5	9.0	μA
Output voltage	Vout	Iout=1mA, Vin=1.5V	3.21	3.30	3.39	V
Output current of LX pin	Ilx	Vout=3.2V, Vlx=0.4V	100			mA
Leakage current of LX pin	Ilxl	Vout=Vlx=10V			1.0	μA
Oscillating frequency	Fosc	Vout=3.2V	22	35	55	kHz
Maximum duty ratio	Duty	Vout=3.2V, Switch"ON"	45	55	65	%

Vout=5.0V(ELM9450B)

L=330μH, D=MA721, C=22μF, Vss=0V, Top=25°C

Parameter	Symbol	Condition	Min.	Typ.	Max.	Unit
Input voltage	Vin				10	V
Starting voltage	Vst	RL=50kΩ			0.98	V
Holding voltage	Vhold	Iout=1mA			0.9	V
Current consumption	Iss	Iout=100μA, Vin=3V		7.0	14.0	μA
Output voltage	Vout	Iout=1mA, Vin=3V	4.87	5.00	5.13	V
Output current of LX pin	Ilx	Vout=4.8V, Vlx=0.4V	130			mA
Leakage current of LX pin	Ilxl	Vout=Vlx=10V			1.0	μA
Oscillating frequency	Fosc	Vout=4.8V	22	35	58	kHz
Maximum duty ratio	Duty	Vout=4.8V, Switch"ON"	50	60	70	%

■ Marking

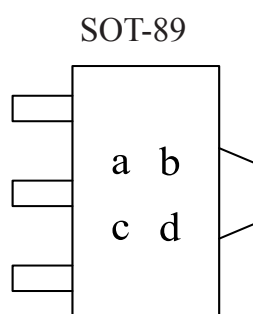

a : the integer digit of the output voltage

Mark	Vout	Mark	Vout
2	2.*V	4	4.*V
3	3.*V	5	5.*V

b : the decimal digit of the output voltage

Mark	Vout	Mark	Vout
0	*.0V	5	*.5V
1	*.1V	6	*.6V
2	*.2V	7	*.7V
3	*.3V	8	*.8V
4	*.4V	9	*.9V

c : Assembly lot No. ——— 0 to 9

d : Assembly lot No. ——— A to Z (excepted I, O, X)

ELM94xxB CMOS PFM step-up DC/DC converter

<http://www.elm-tech.com>

■ External parts

To design DC/DC converter with ELM94 series, coil, diode, and capacitor are necessary.
(Refer to standard circuit configuration.)

1) Coil

When choosing choke coil, please select that whose core is not magnetically saturated, DC resistance is low, and which has sufficient margin for rated current.

For ELM94 series, ELM recommends following coil.

- CM-5/CM-5N (Sumida Electric Co., Ltd.)

2) Diode

When choosing diode, please select that whose forward voltage is small, switching speed is high and which has sufficient margin for rated current.

For ELM94 series, ELM recommends schottoky diodes.

3) Capacitor

When choosing capacitor, please select that which is generally used for smoothing power supply circuit, with comparatively large capacity and whose rated voltage is at least three times larger than rated output voltage of used ELM94 series.

For ELM94 series, ELM recommends Aluminum electrolytic or Tantalum capacitor.

■ Design of DC/DC converter

In DC/DC converter which consists of ELM94 series and above-mentioned external parts, the output is acquired as follows:

1) Output current of DC/DC converter

The current from output terminal (VO_{UT}) of the circuit is:

$$I_{out} = K \frac{V_{in}^2}{8 \cdot L \cdot F_{osc} \cdot (V_{out} - V_{in})} \quad * \text{Duty}=50\%$$

K: the efficiency of whole circuit (≈75% to ≈85%)

2) Remedies for noise

This DC/DC converter may cause electromagnetic noise due to switching of coil under large current. Solution is necessary especially when the IC is used in wireless devices.

To reduce noise, this IC is designed in consideration of coil switching characteristics. The following methods are also effective to reduce noise.

- Use shield-type, or magnetic shield coil.
- Locate coil and diode to the LX terminal of IC as close as possible.
- Select ground wire as thick and short as possible.
- Connect ground wire of circuit to one point.

ELM94xxB CMOS PFM step-up DC/DC converter

<http://www.elm-tech.com>

■ Typical characteristics

- $V_{out}=2.7V$ (ELM9427B) ($T_{op}=25^{\circ}C$, $L=330\mu H$, $D=MA721$, $C=22\mu F$)

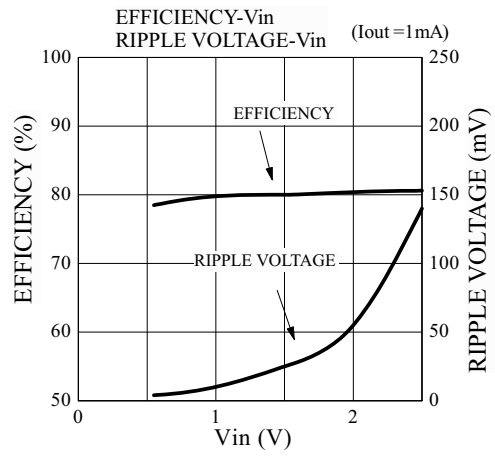
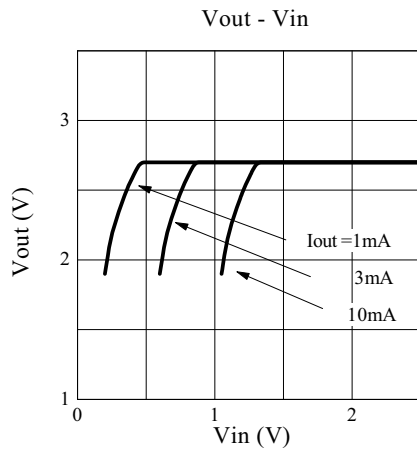

- $V_{out}=3.0V$ (ELM9430B) ($T_{op}=25^{\circ}C$, $L=330\mu H$, $D=MA721$, $C=22\mu F$)

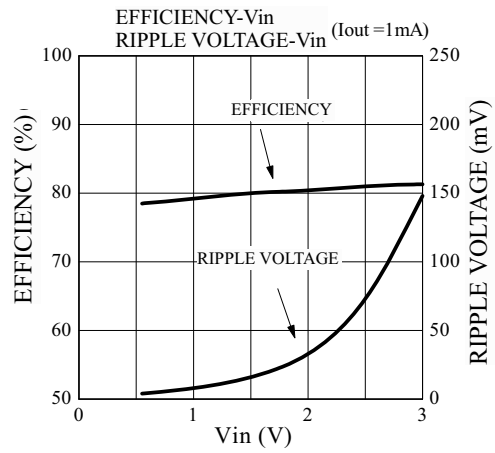
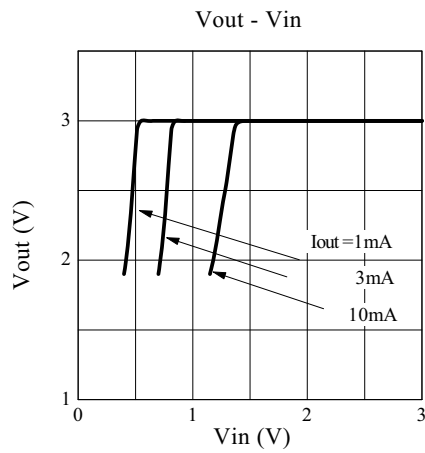

ELM94xxB CMOS PFM step-up DC/DC converter

<http://www.elm-tech.com>

- Vout=3.3V (ELM9433B) (Top=25°C, L=330μH, D=MA721, C=22μF)

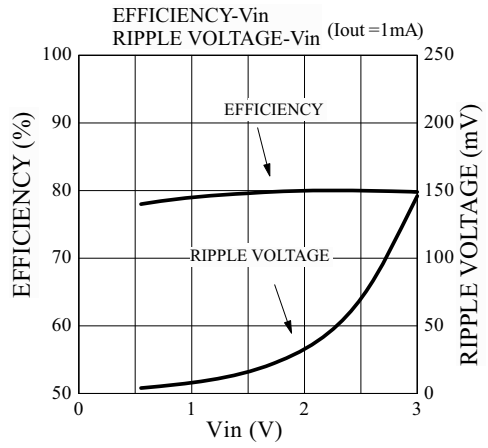
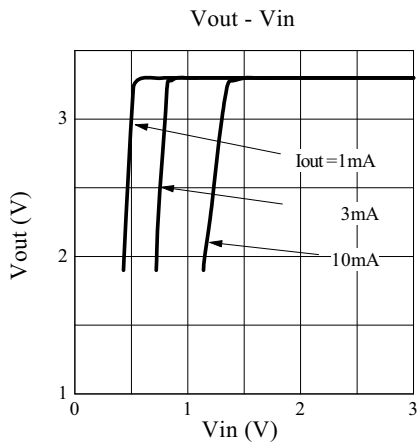

- Vout=5.0V (ELM9450B) (Top=25°C, L=330μH, D=MA721, C=22μF)

