

IR MODEL

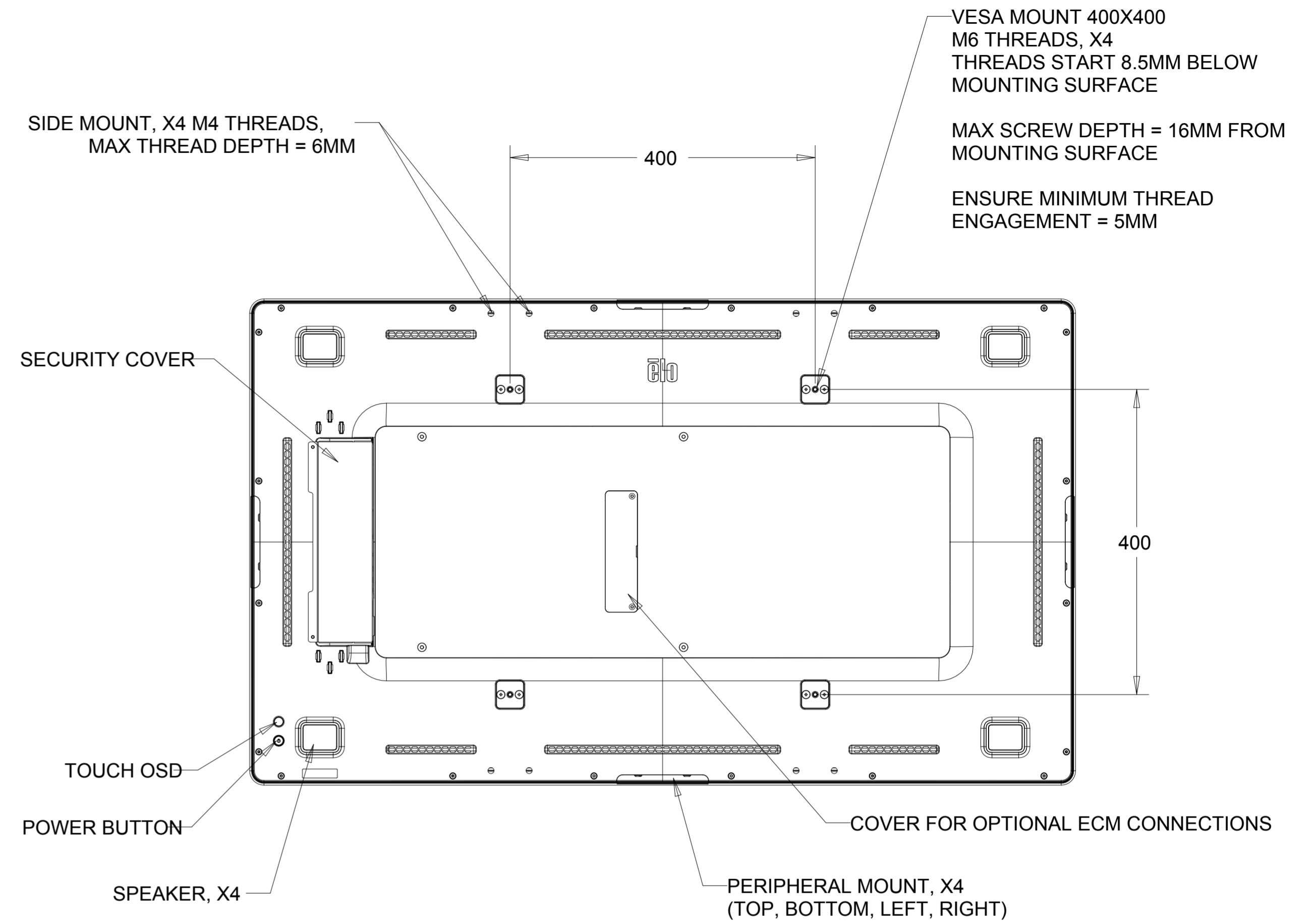

I/O CONNECTIONS
(UNDER SECURITY COVER)

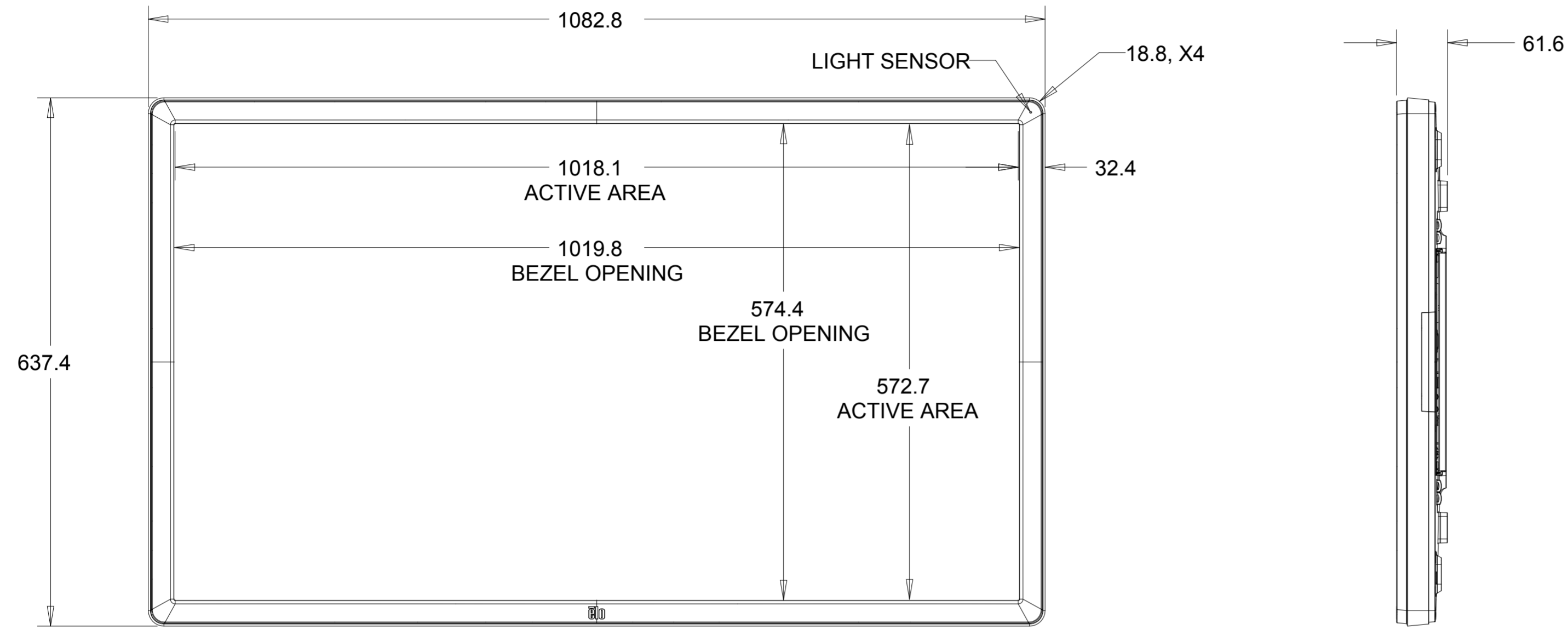
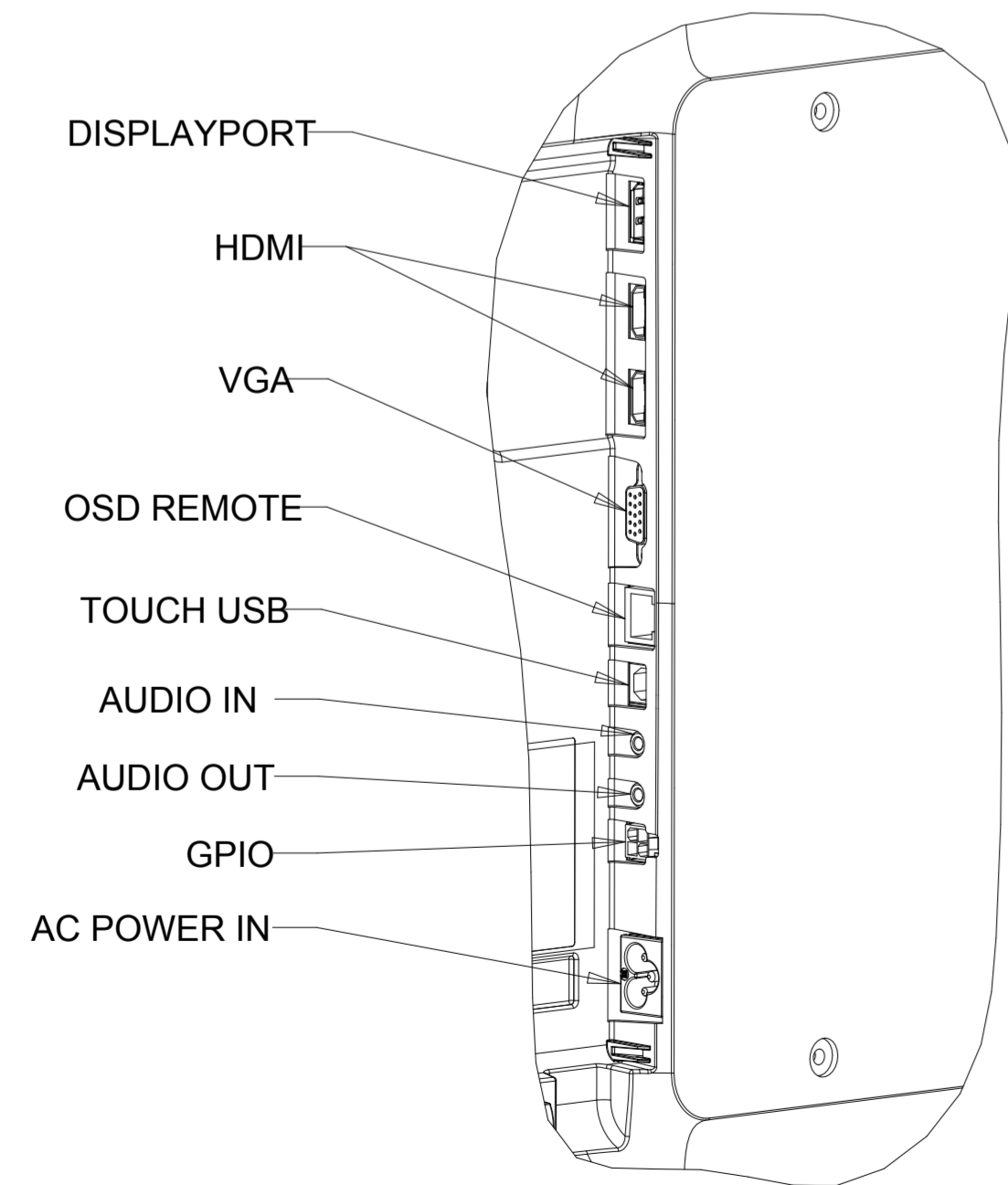

IR MODEL WITH OPTIONAL ECM KIT

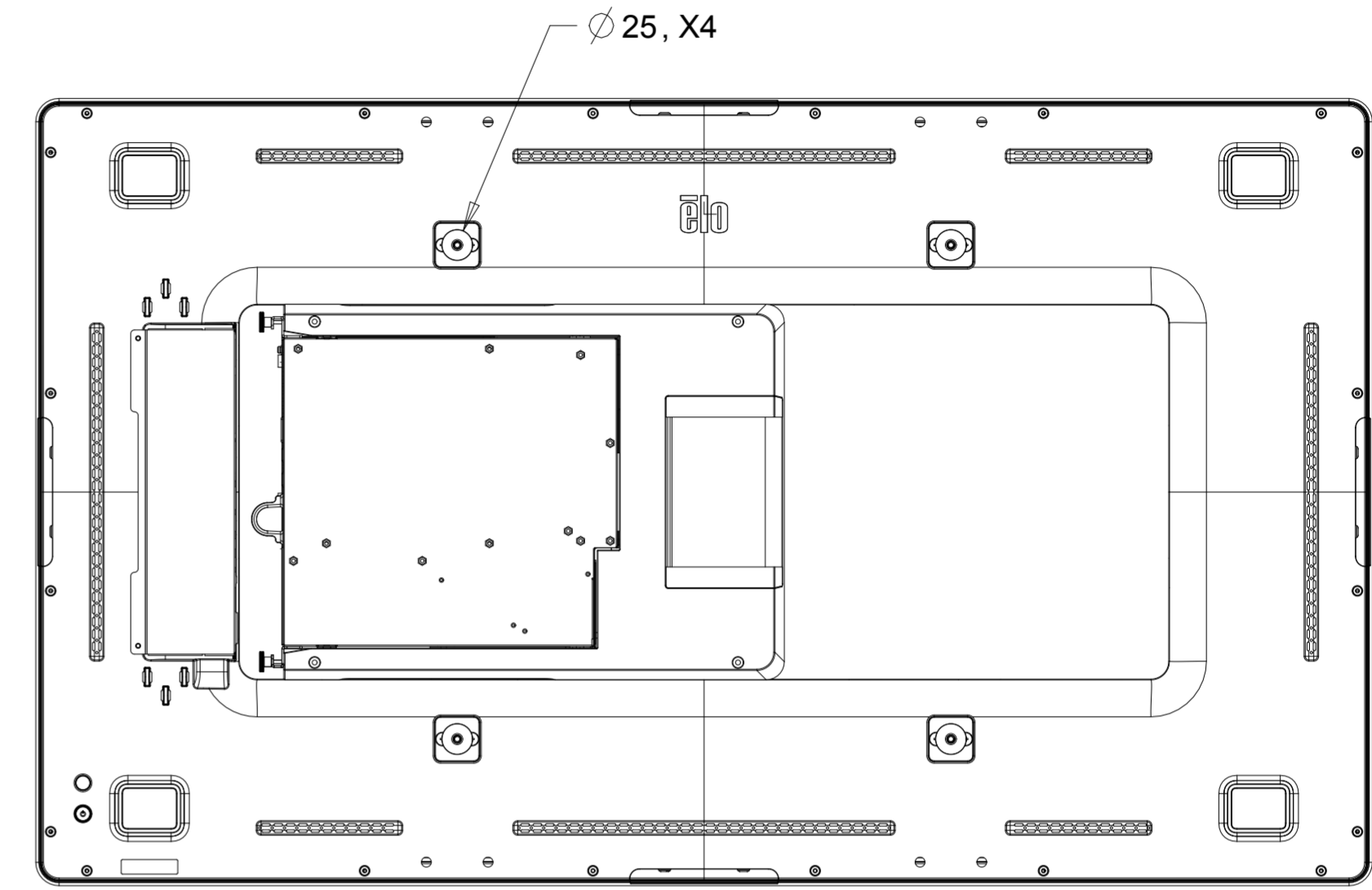
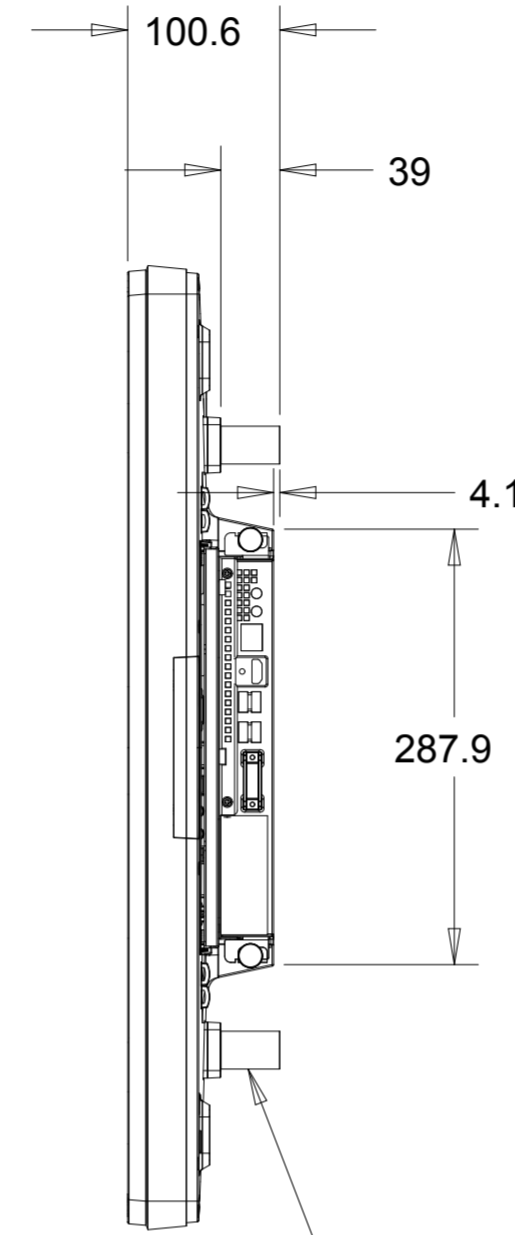
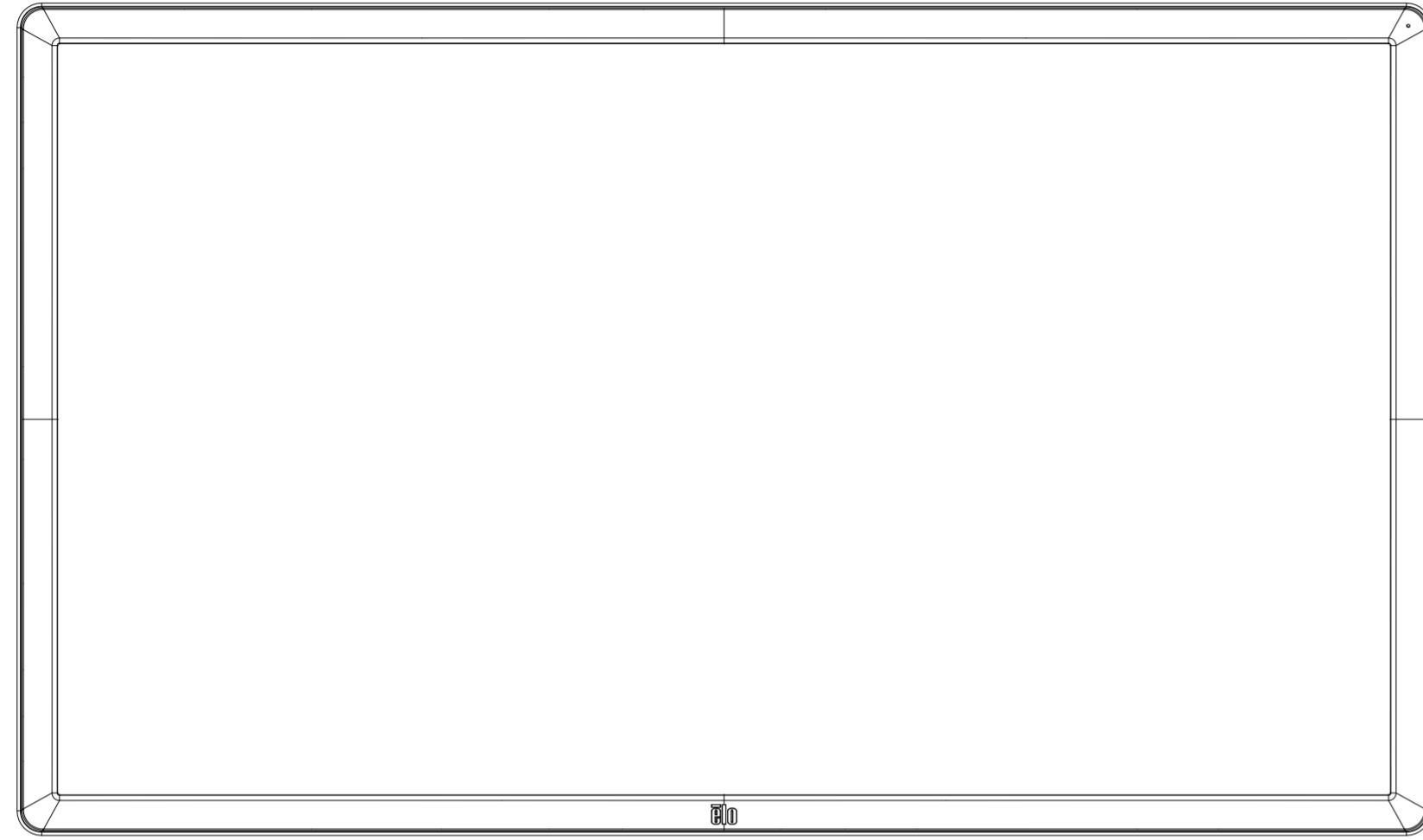

OPTIONAL EXTENSION SPACERS AND SCREWS (X4)
INCLUDED WITH ECM KIT

ECM CONNECTIONS ON SAME SIDE
AS IDS I/O CONNECTIONS

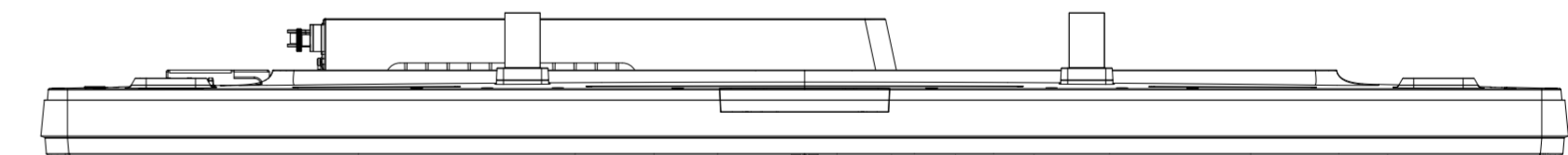
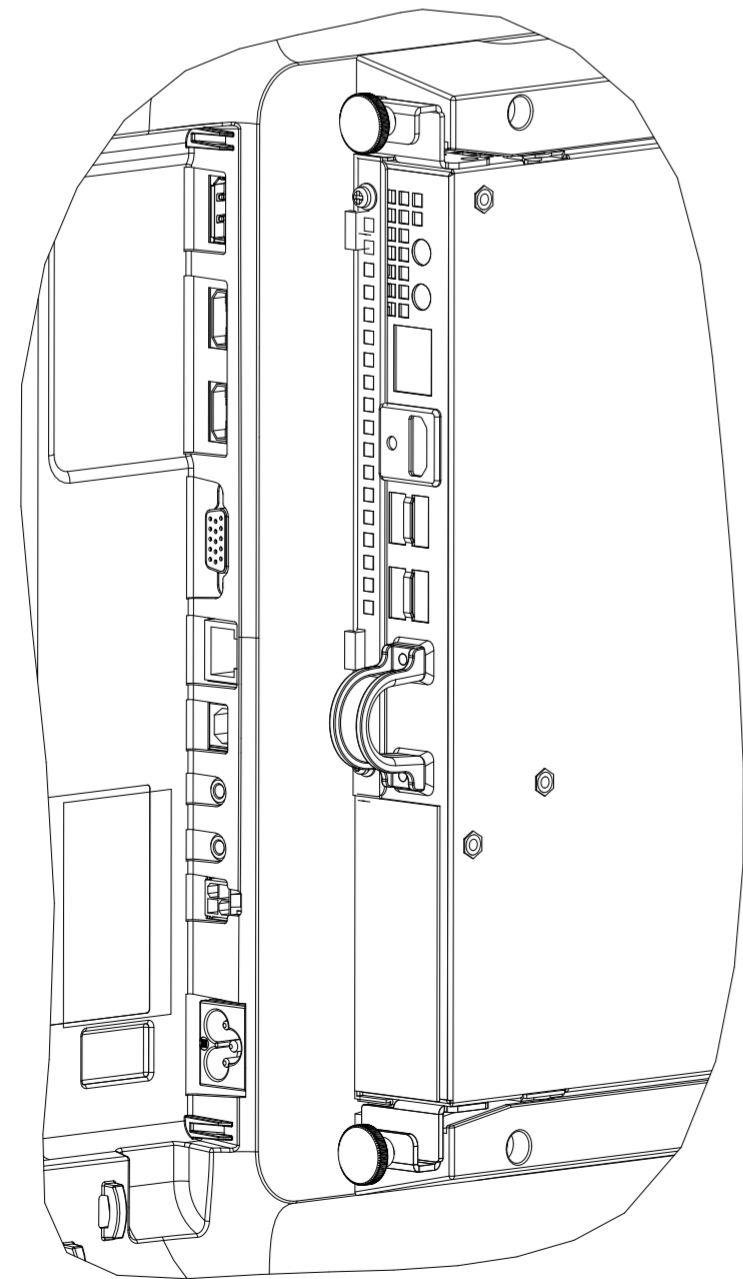

PROJECTED CAPACITIVE MODEL

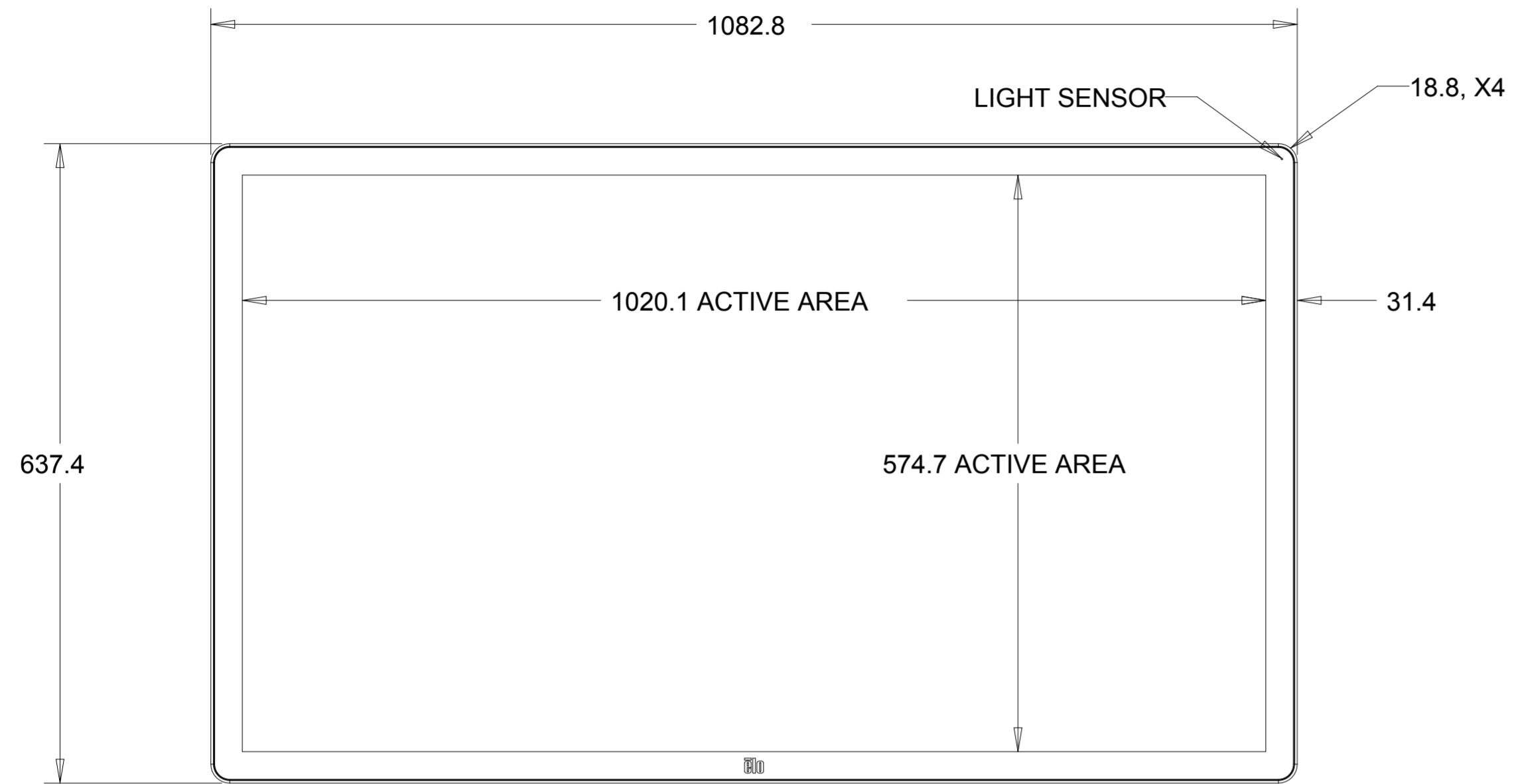

I/O CONNECTIONS
(UNDER SECURITY COVER)

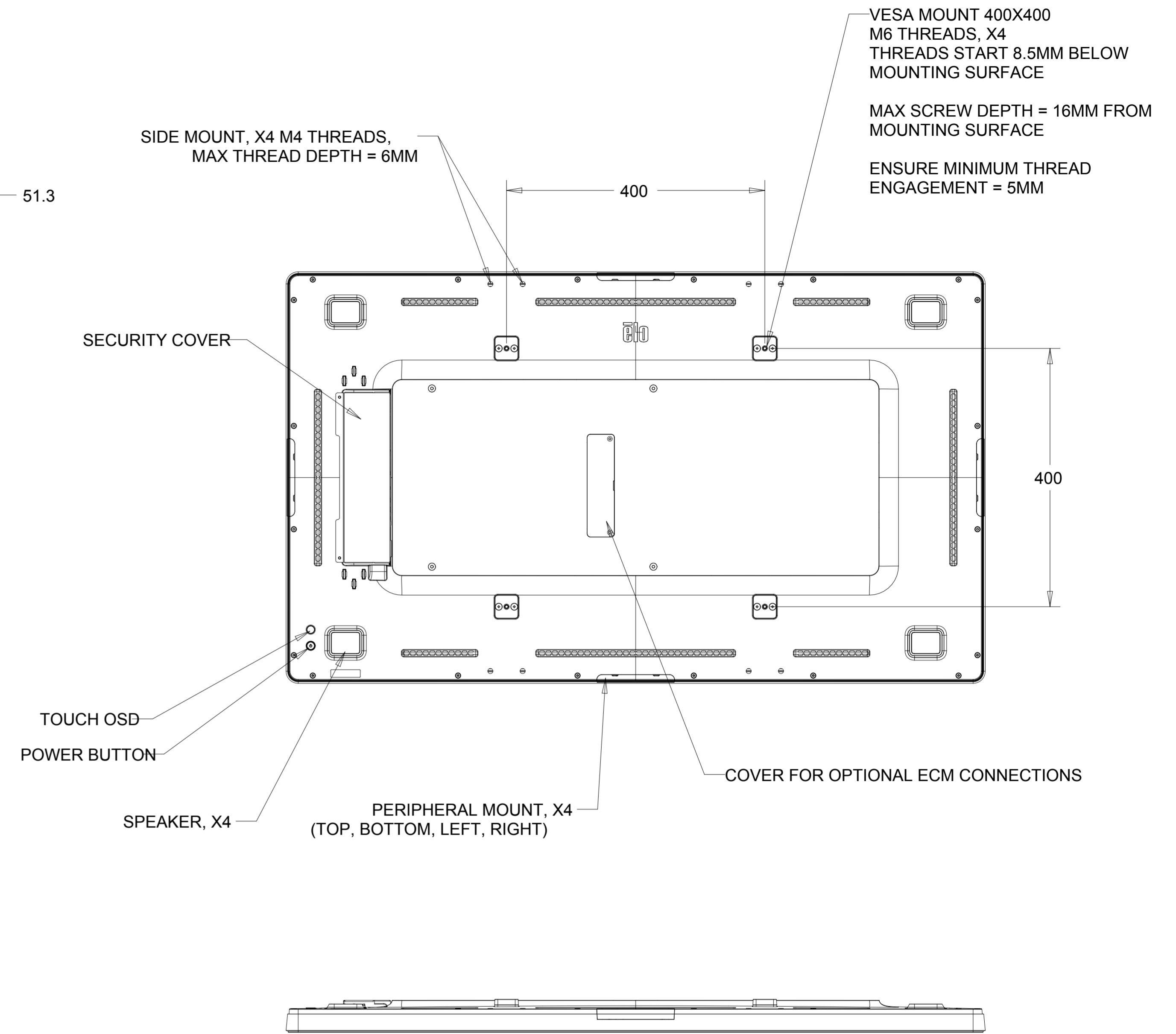
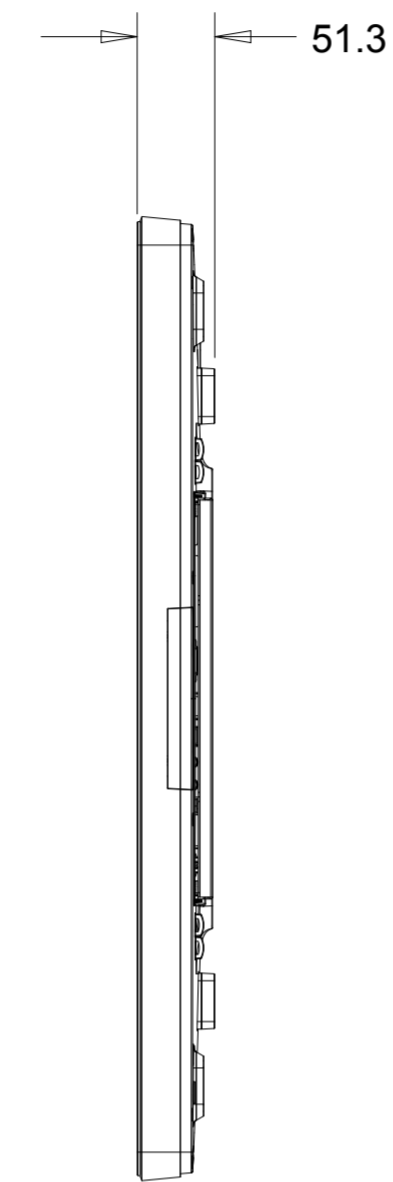
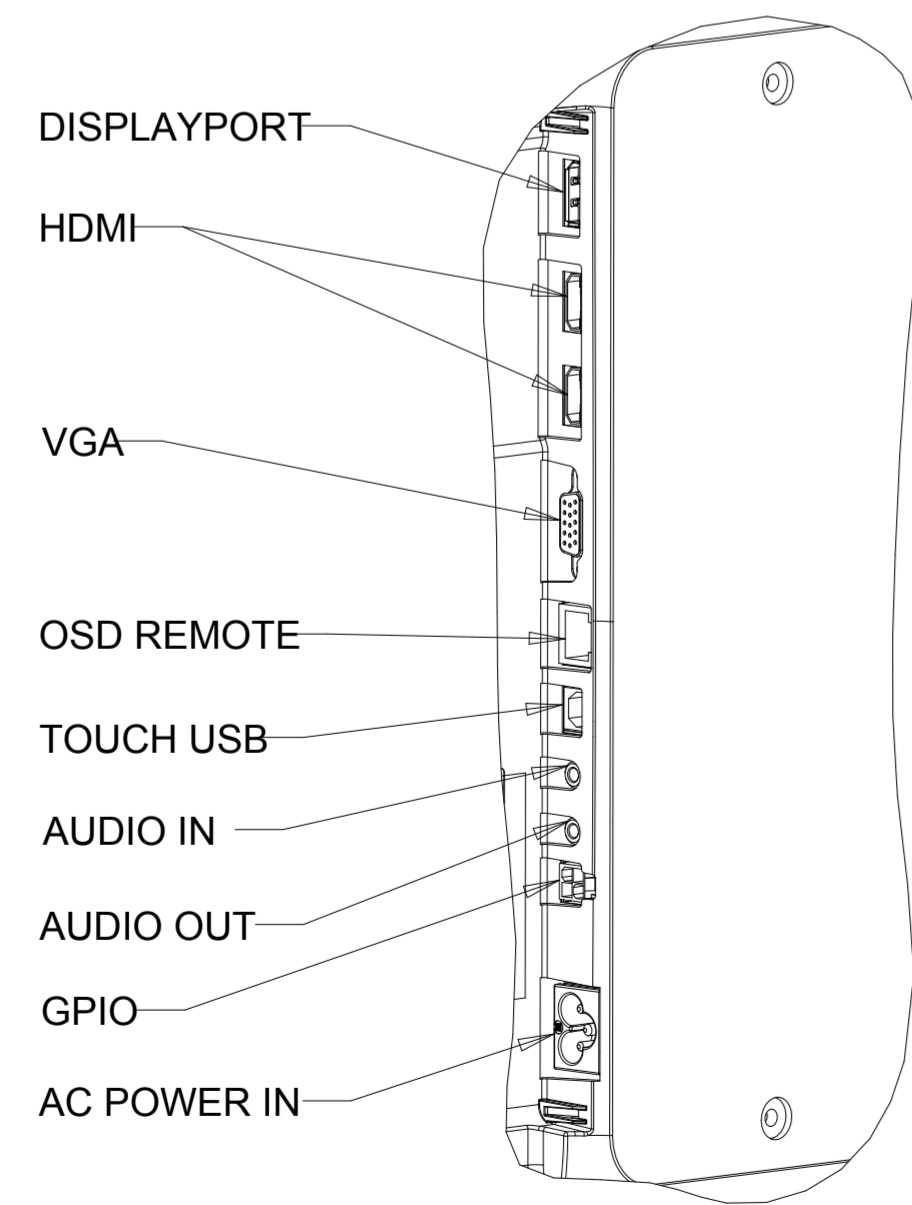

PROJECTED CAPACITIVE MODEL WITH OPTIONAL ECM KIT

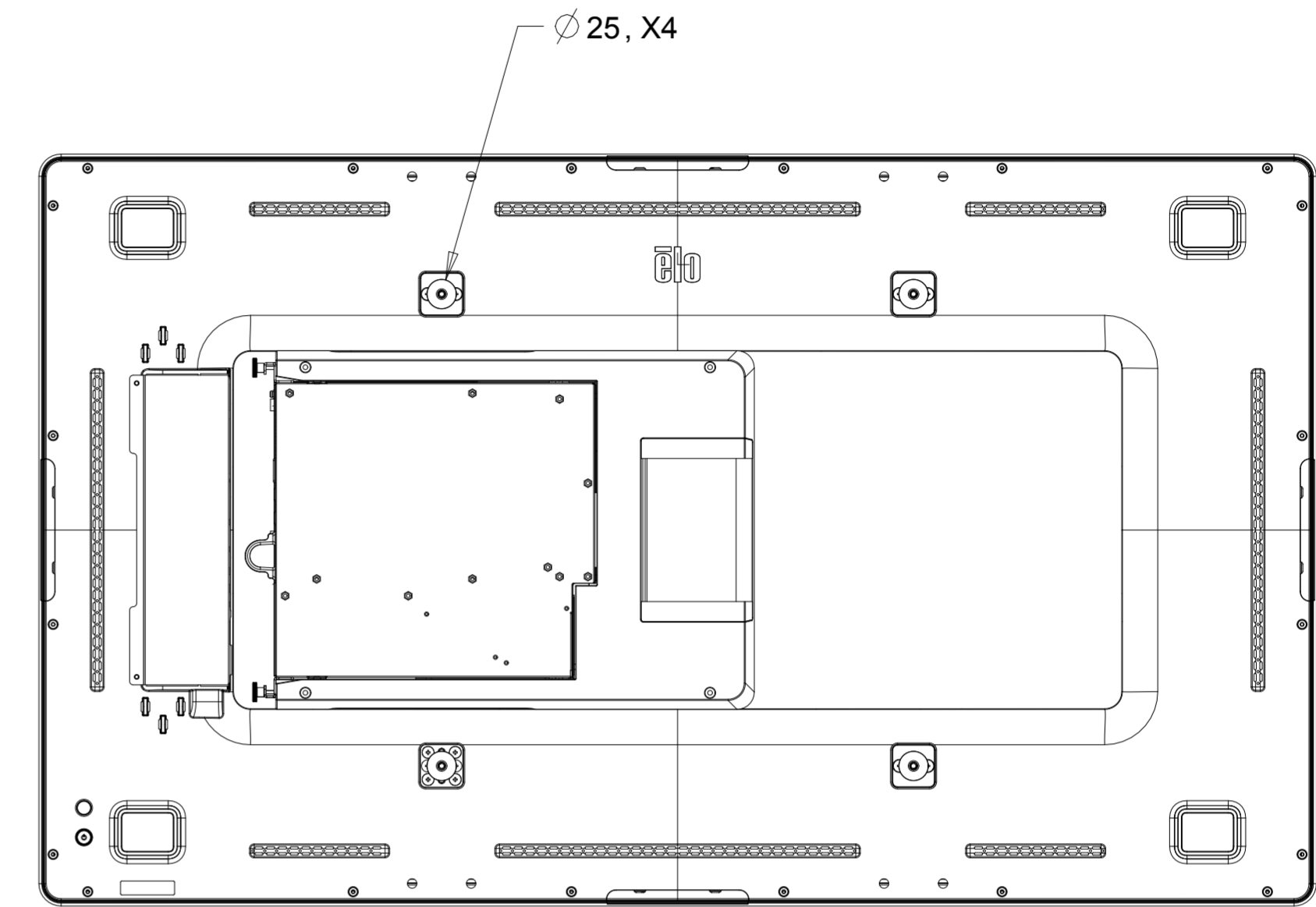
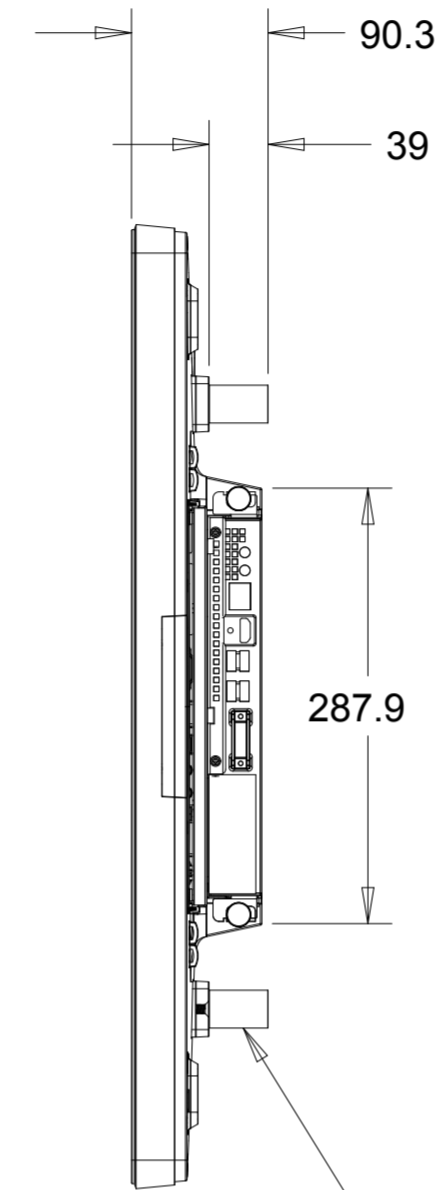
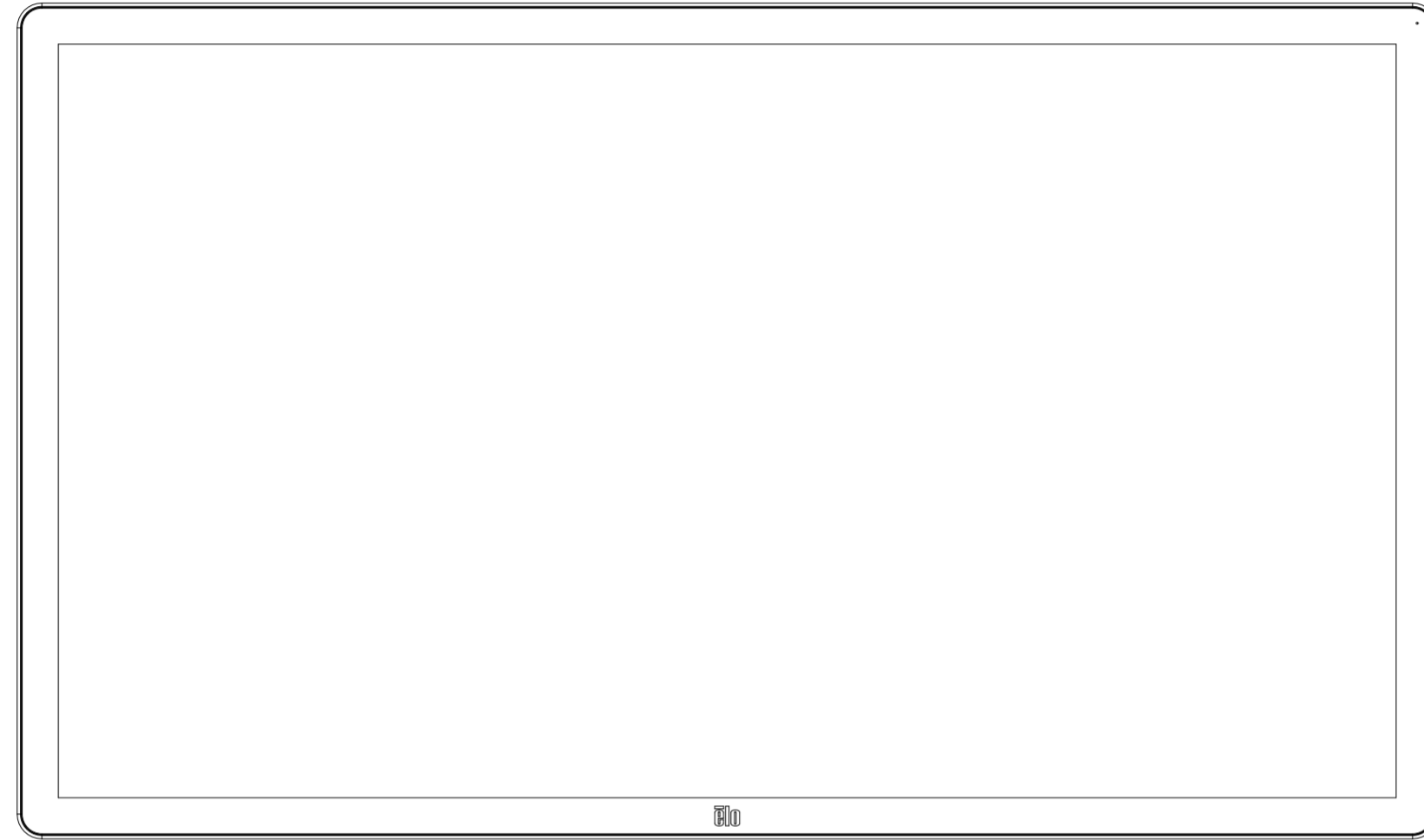

OPTIONAL EXTENSION SPACERS AND SCREWS (X4)
INCLUDED WITH ECM KIT

ECM CONNECTIONS ON SAME SIDE
AS IDS I/O CONNECTIONS

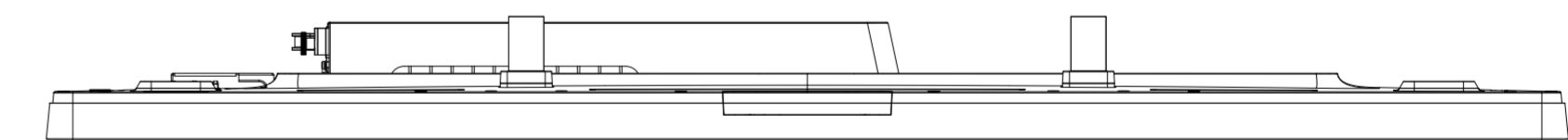
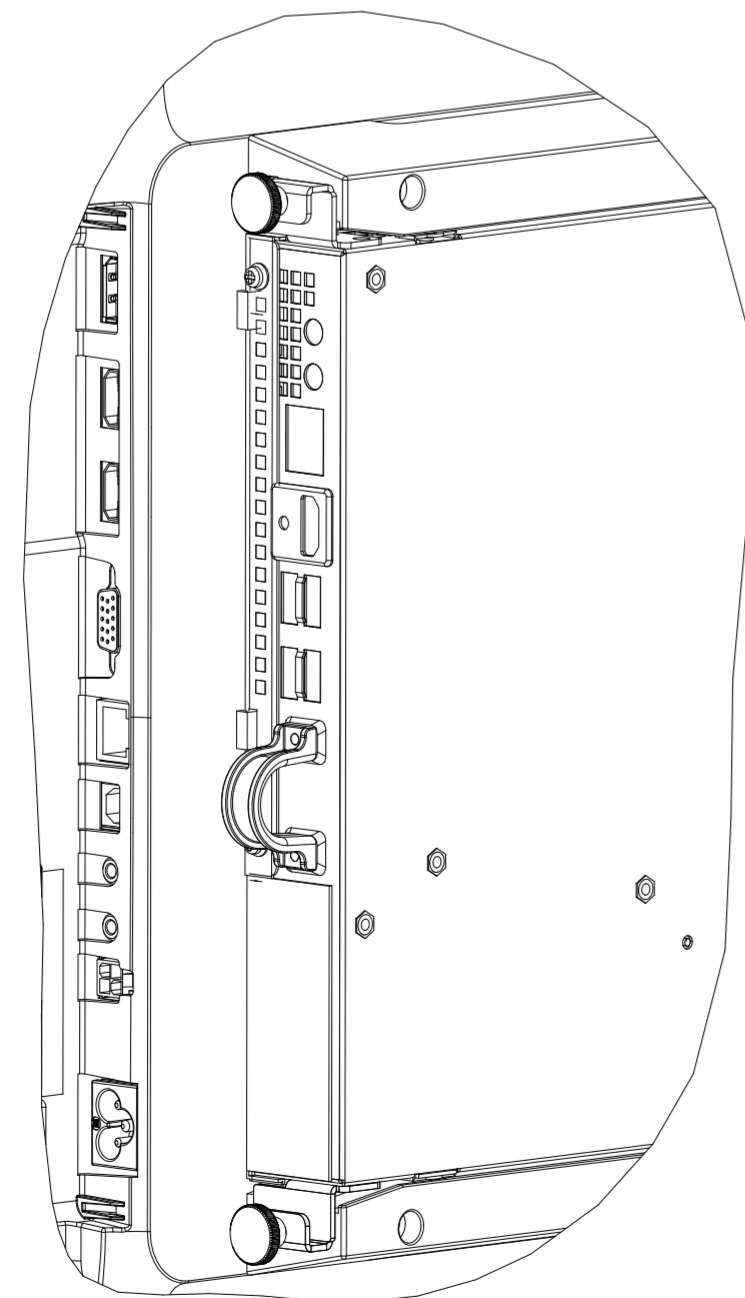

OPTIONAL STAND KIT P/N E275623

LANDSCAPE ORIENTATION
(PORTRAIT ORIENTATION NOT SUPPORTED)

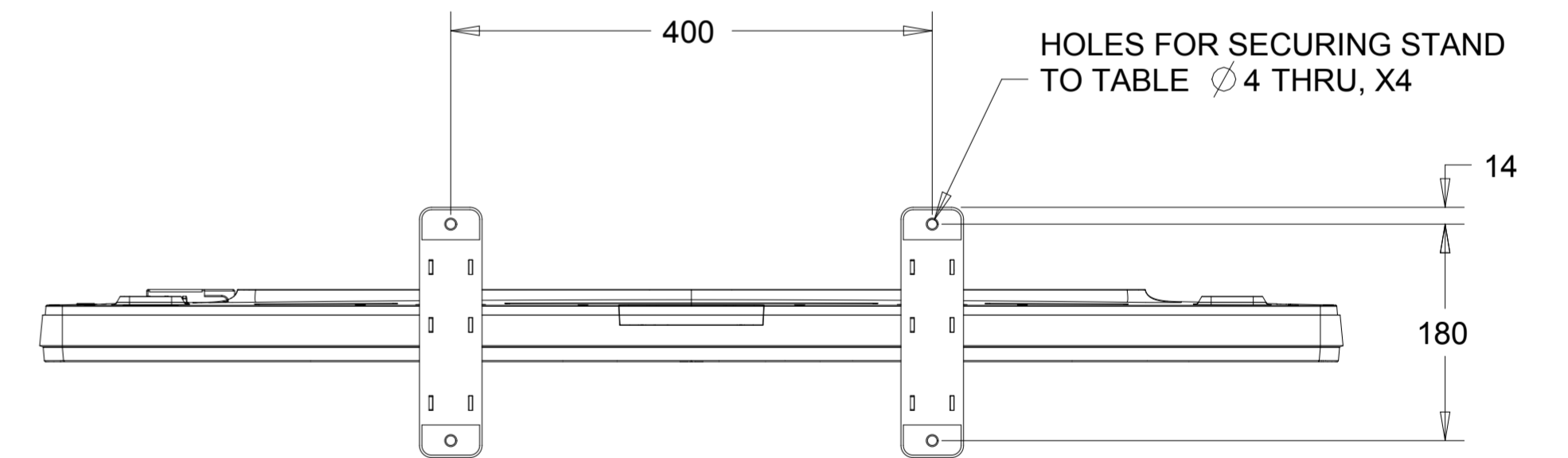
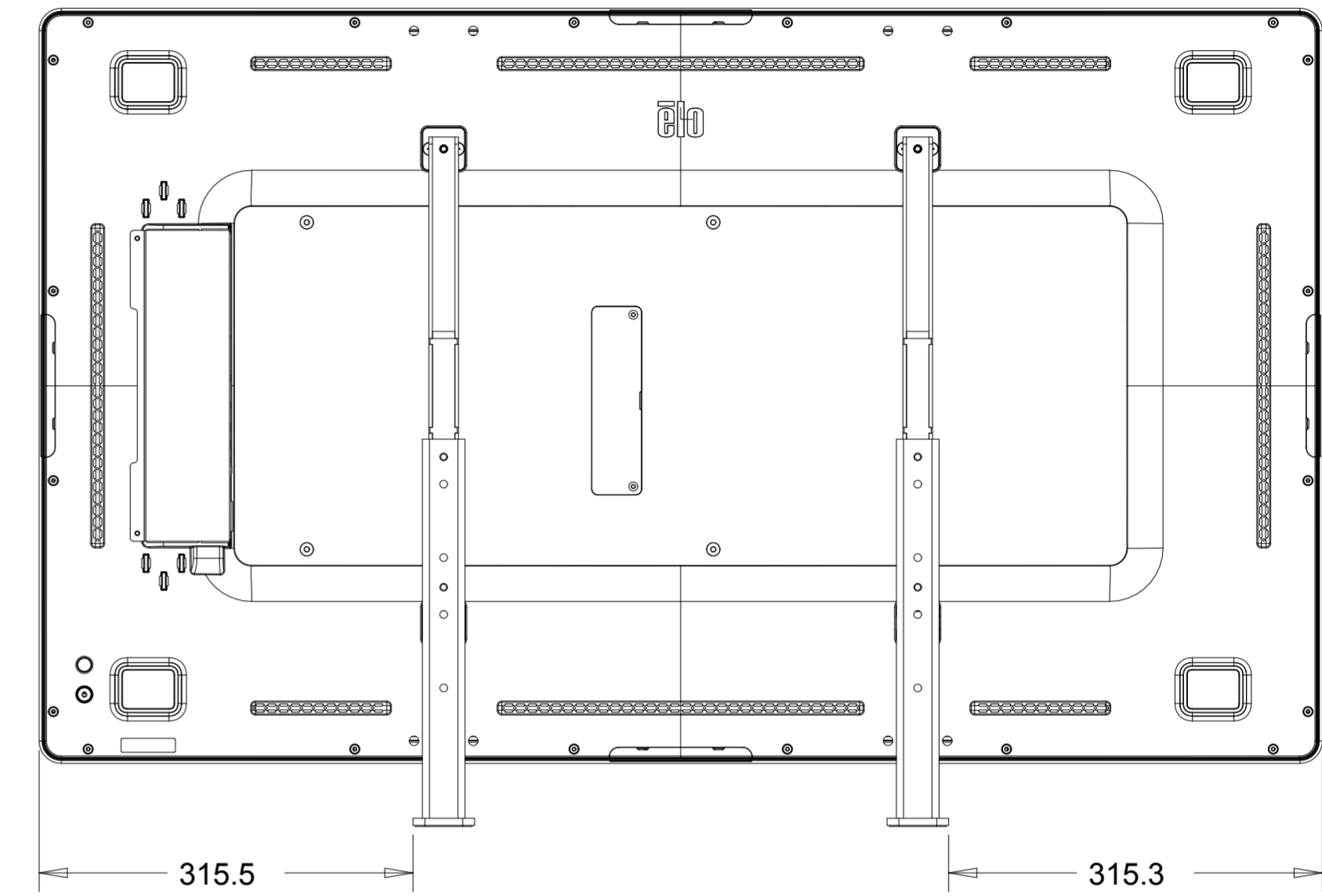
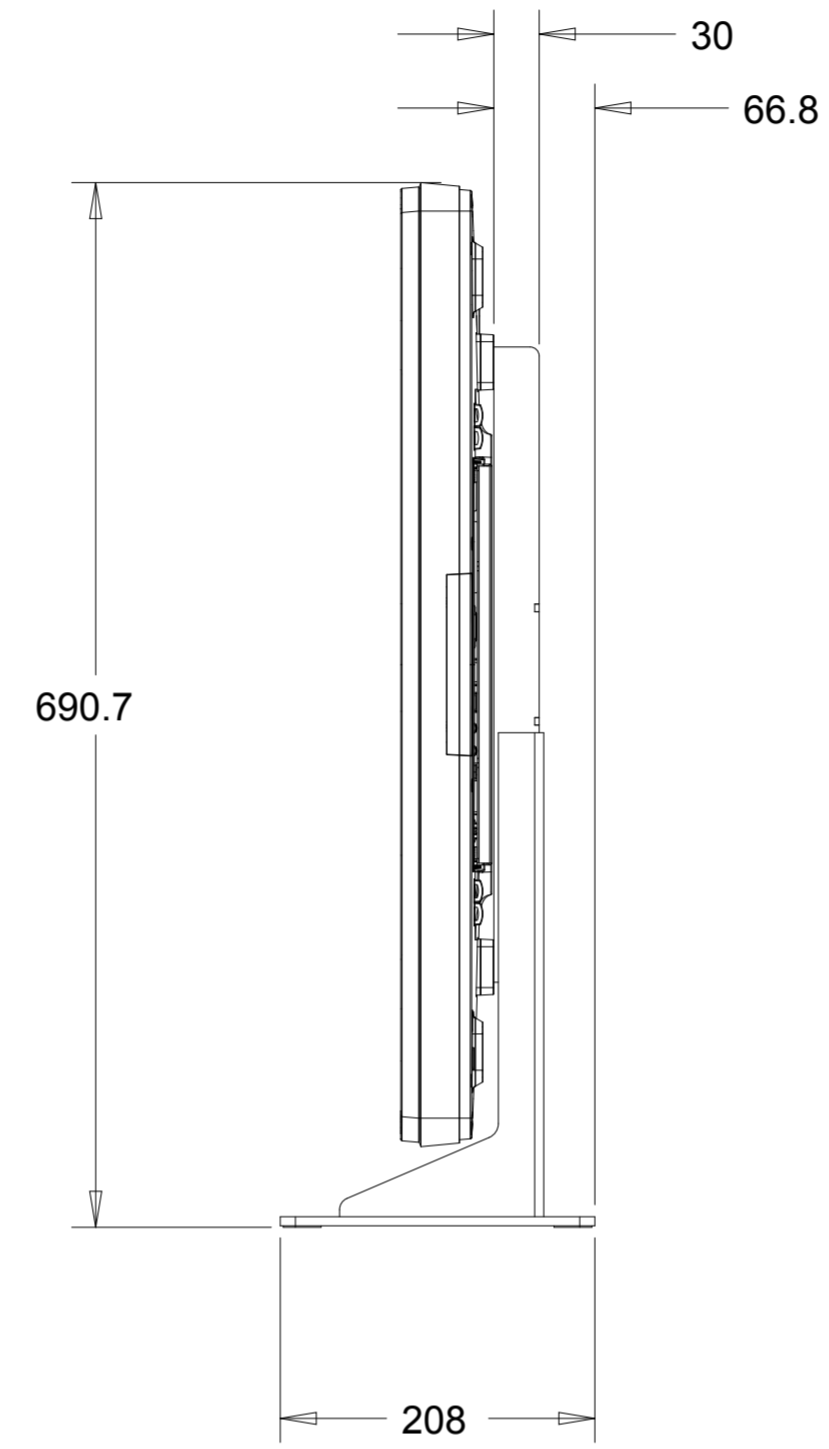
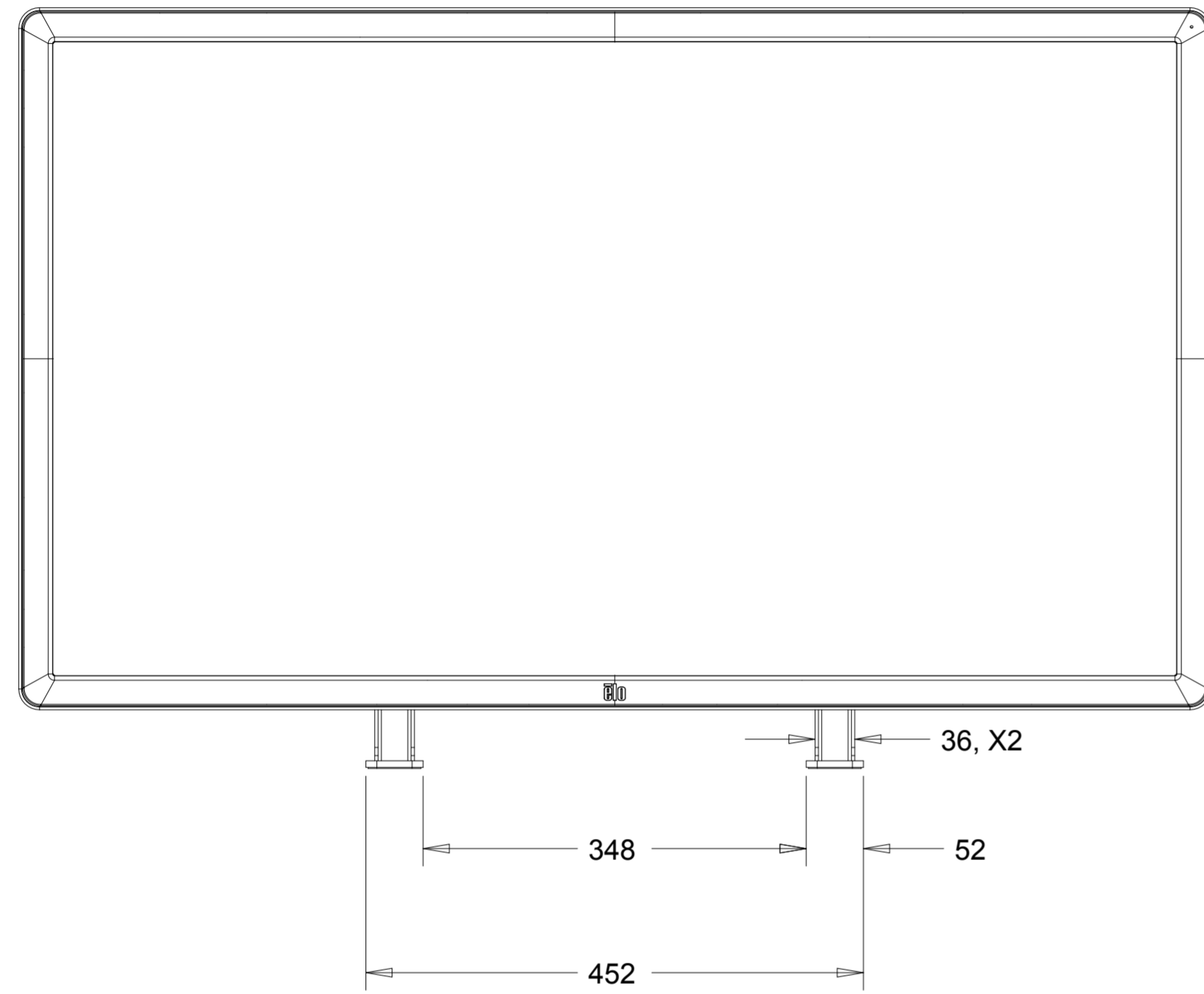

OPTIONAL LOW PROFILE WALLMOUNT KIT P/N E275050
SEE NEXT PAGE FOR DIMENSIONS WITH ECM KIT

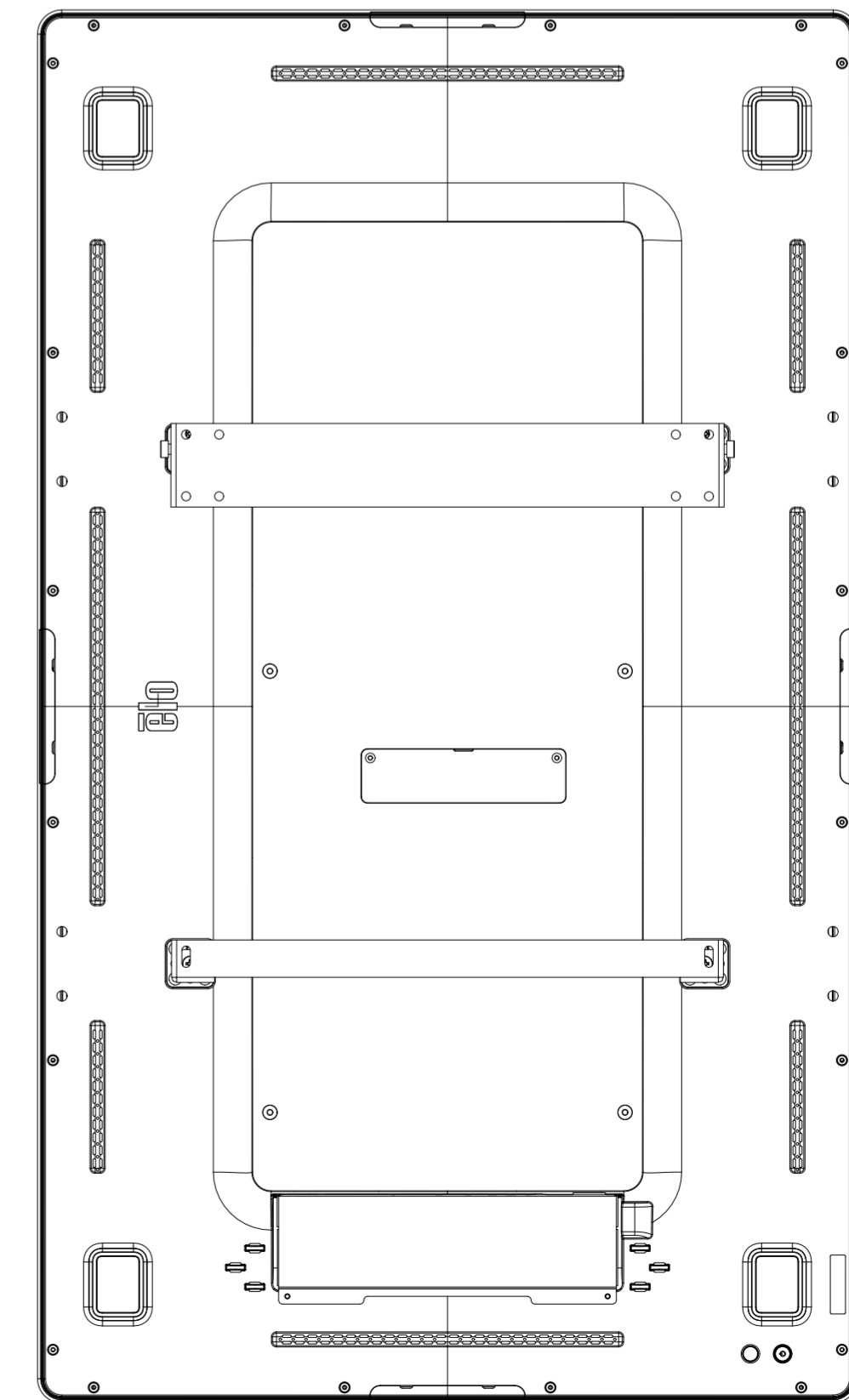
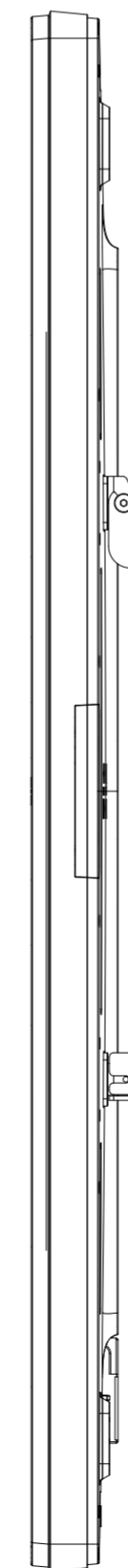
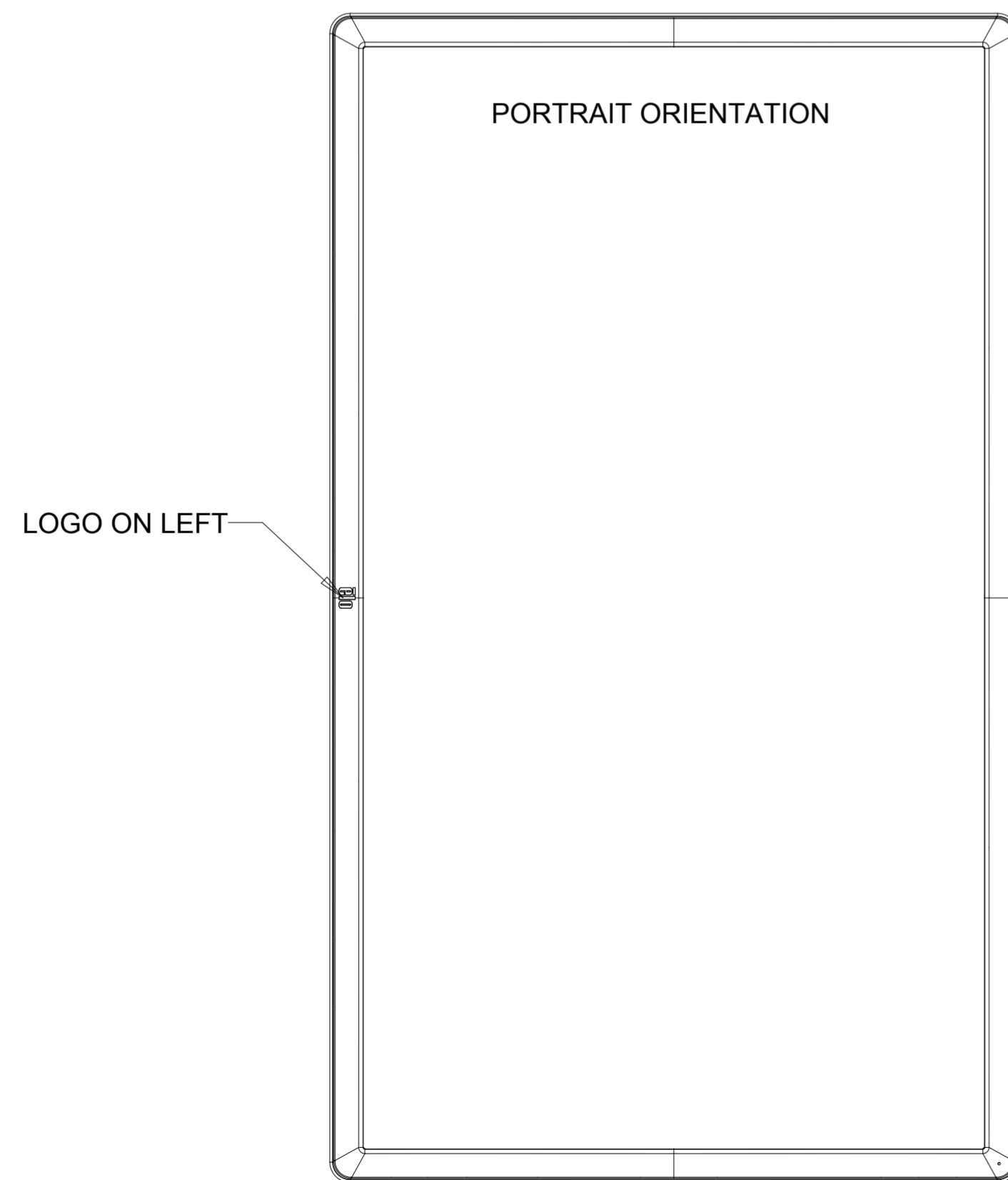
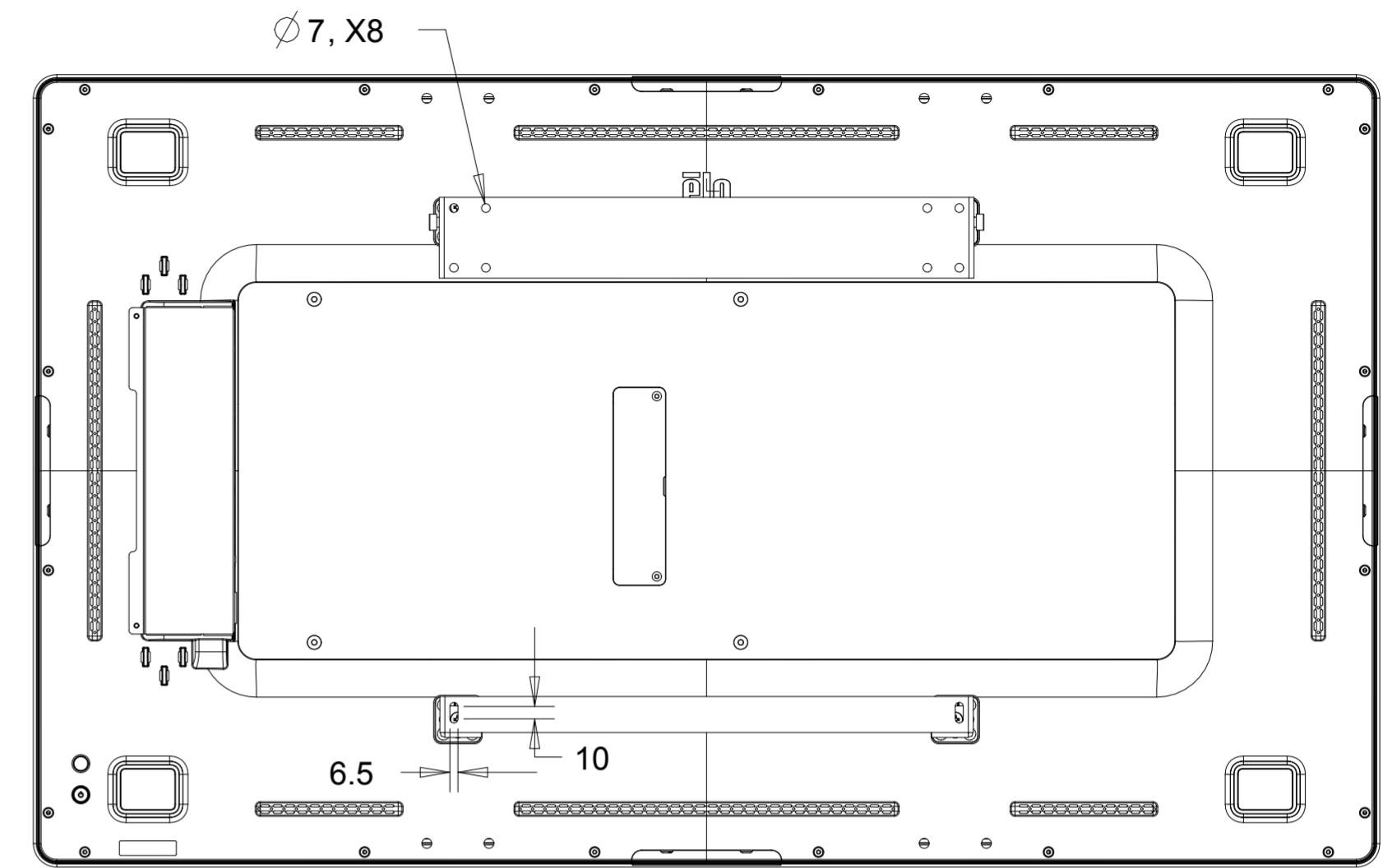
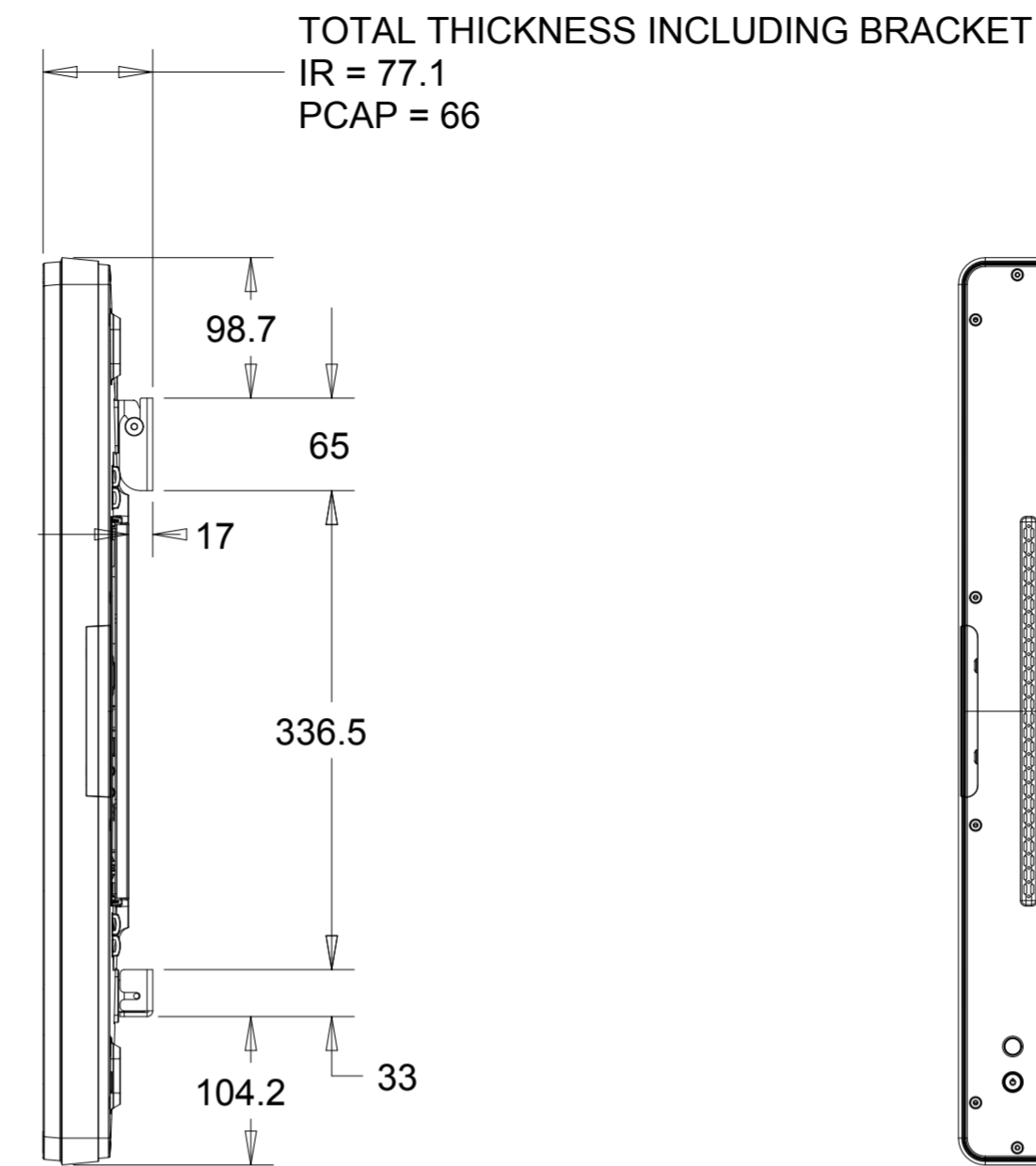
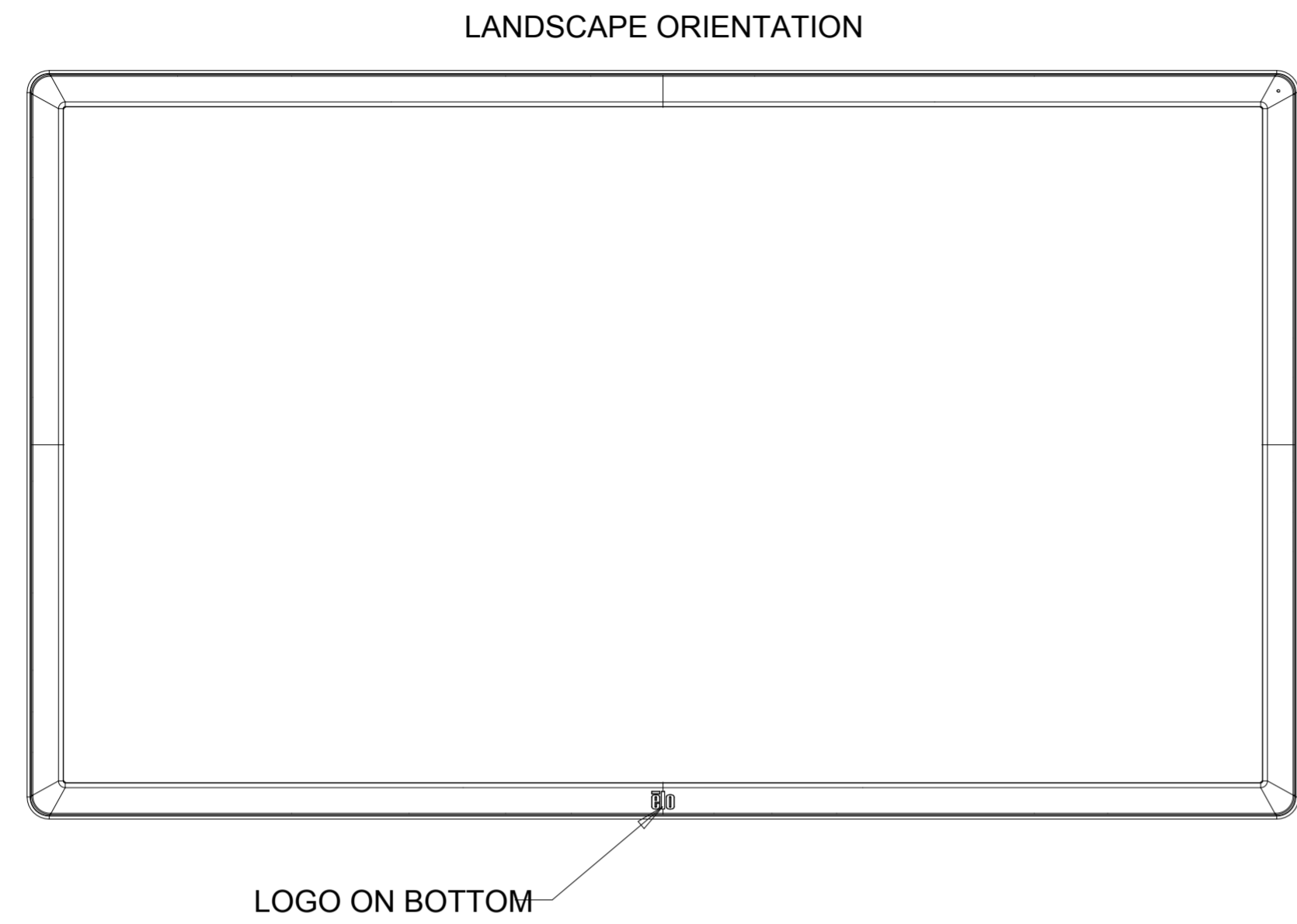

OPTIONAL LOW PROFILE WALLMOUNT KIT P/N E275050
WITH OPTIONAL ECM KIT.

SEE PREVIOUS PAGE FOR DIMENSIONS WITHOUT ECM KIT

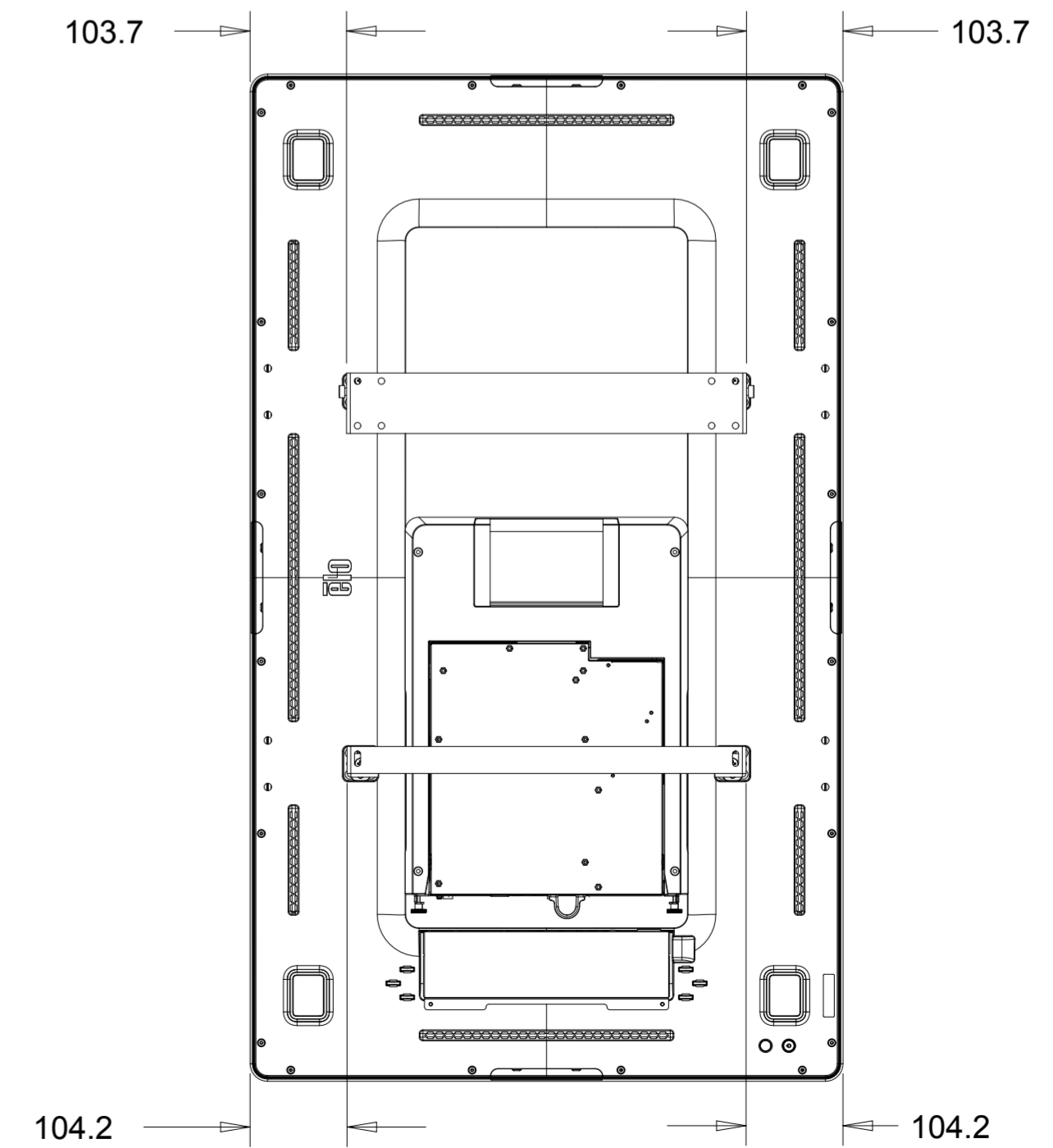
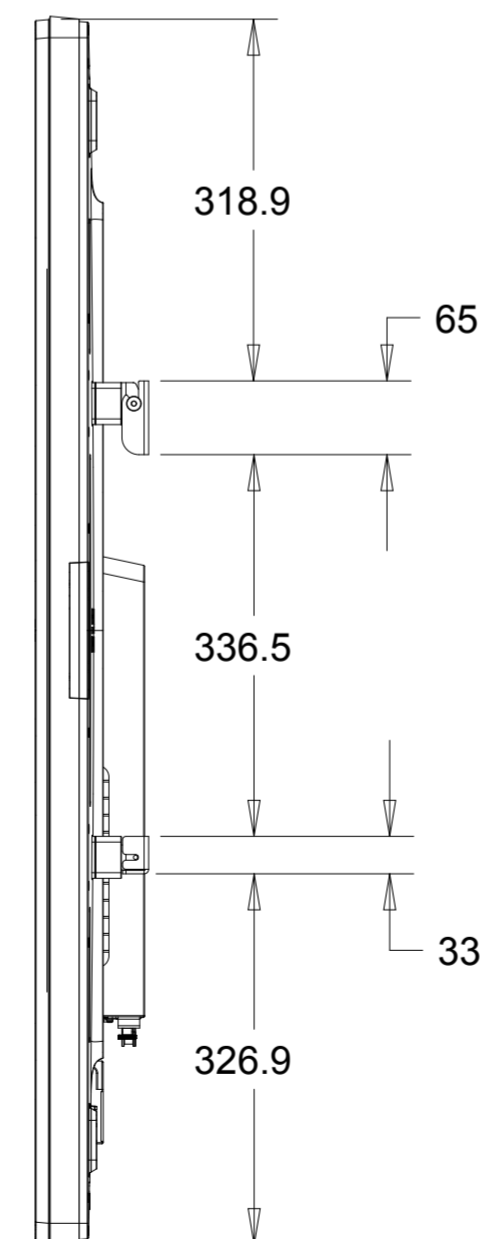
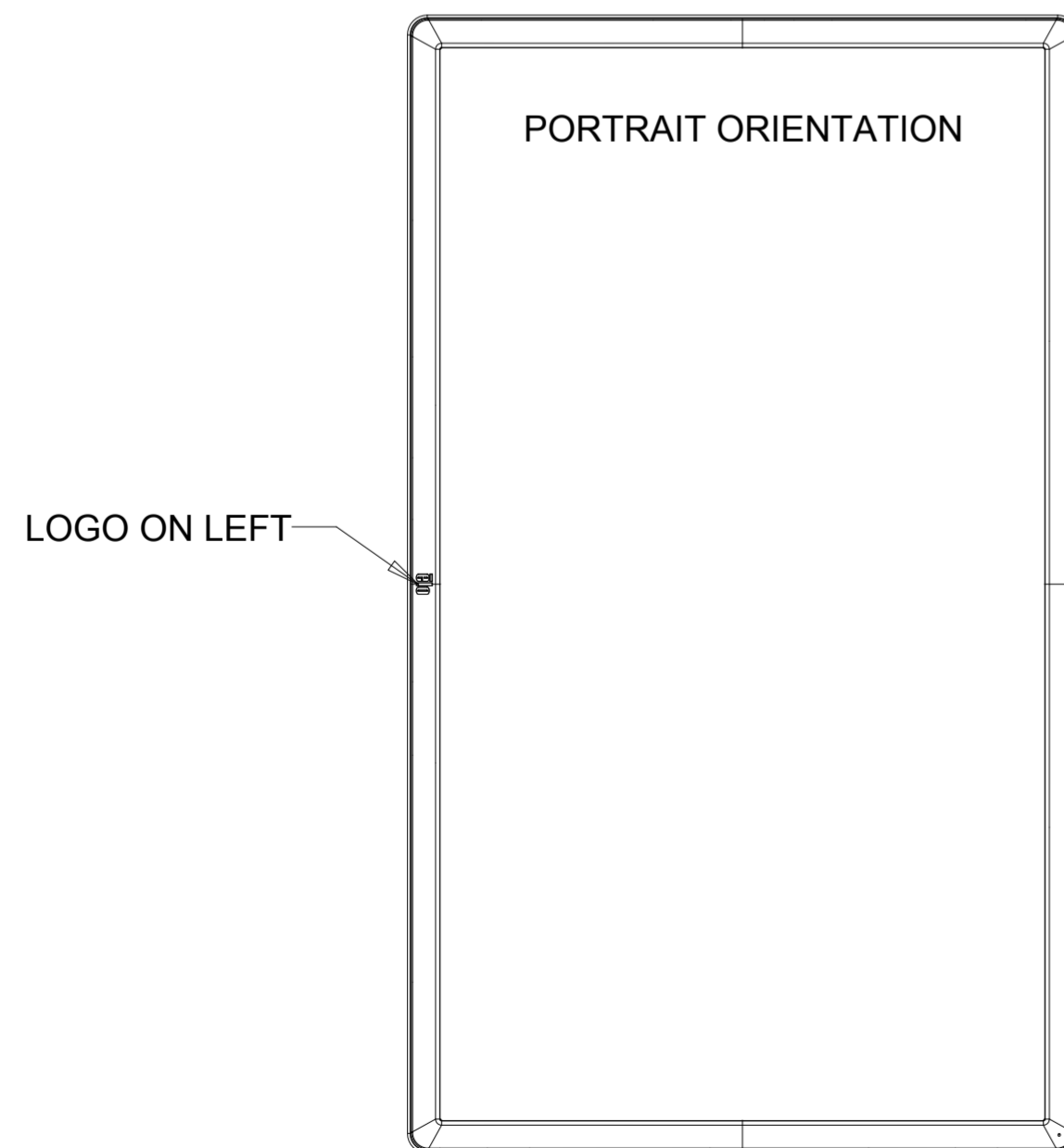
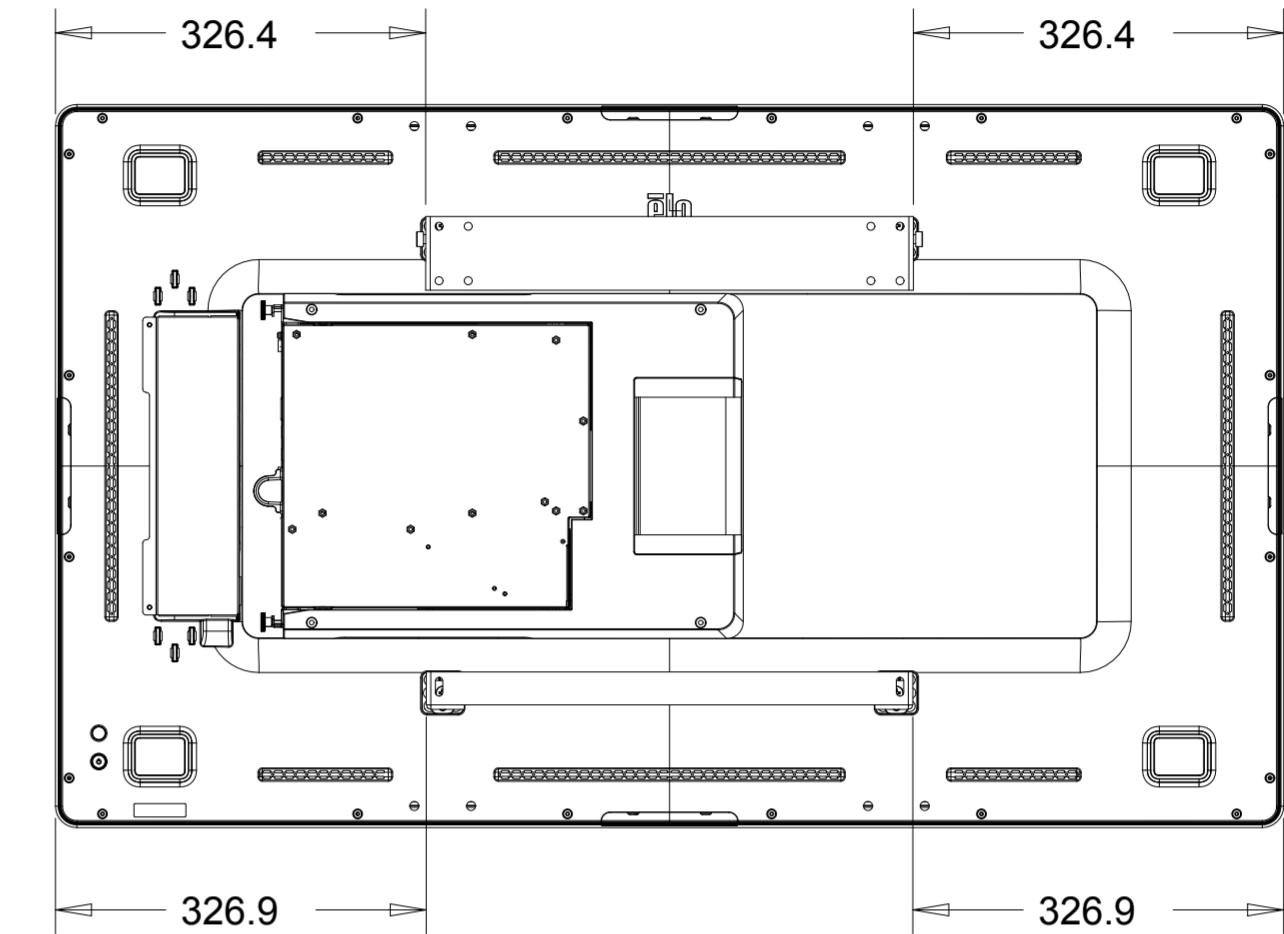
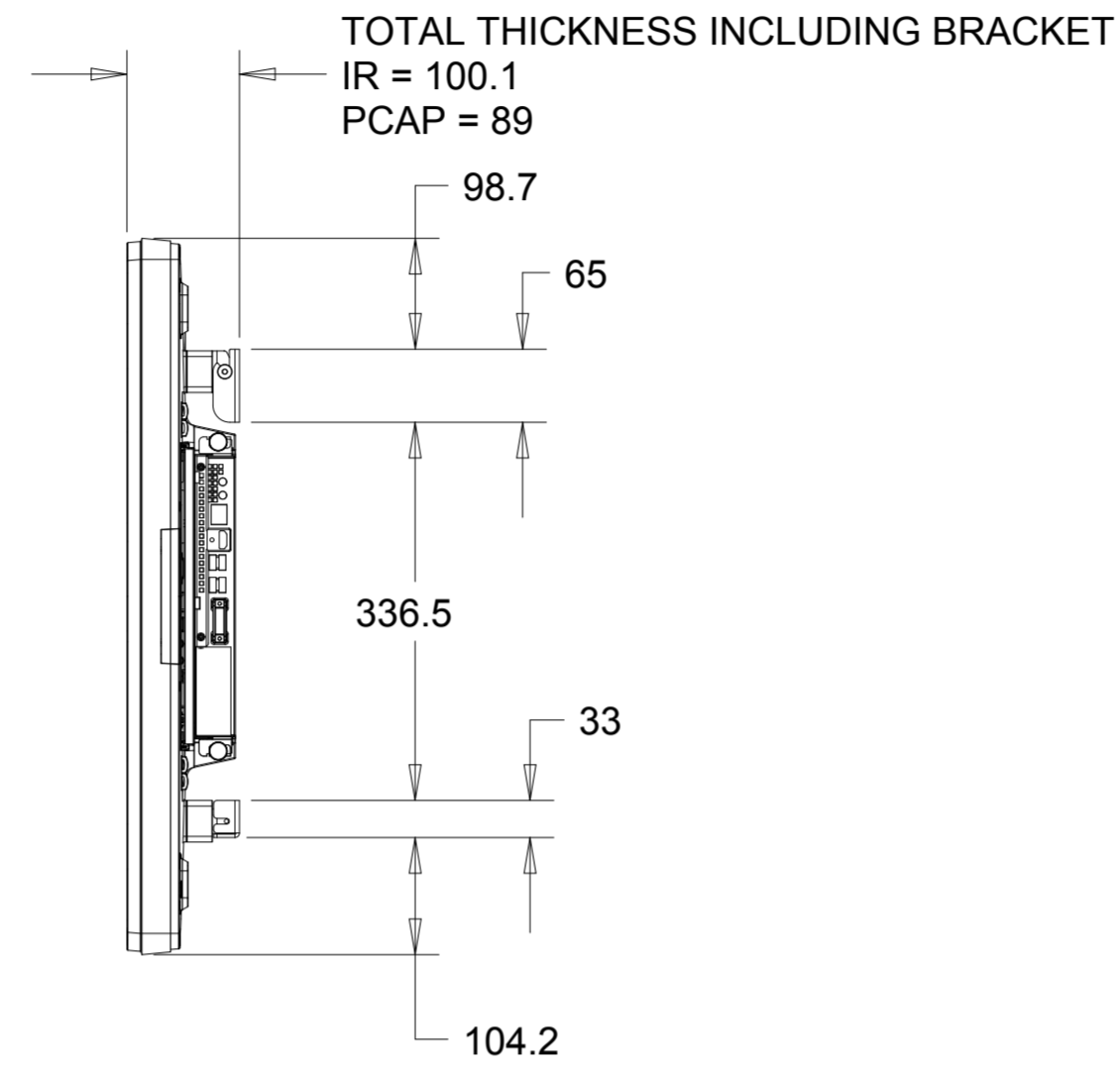
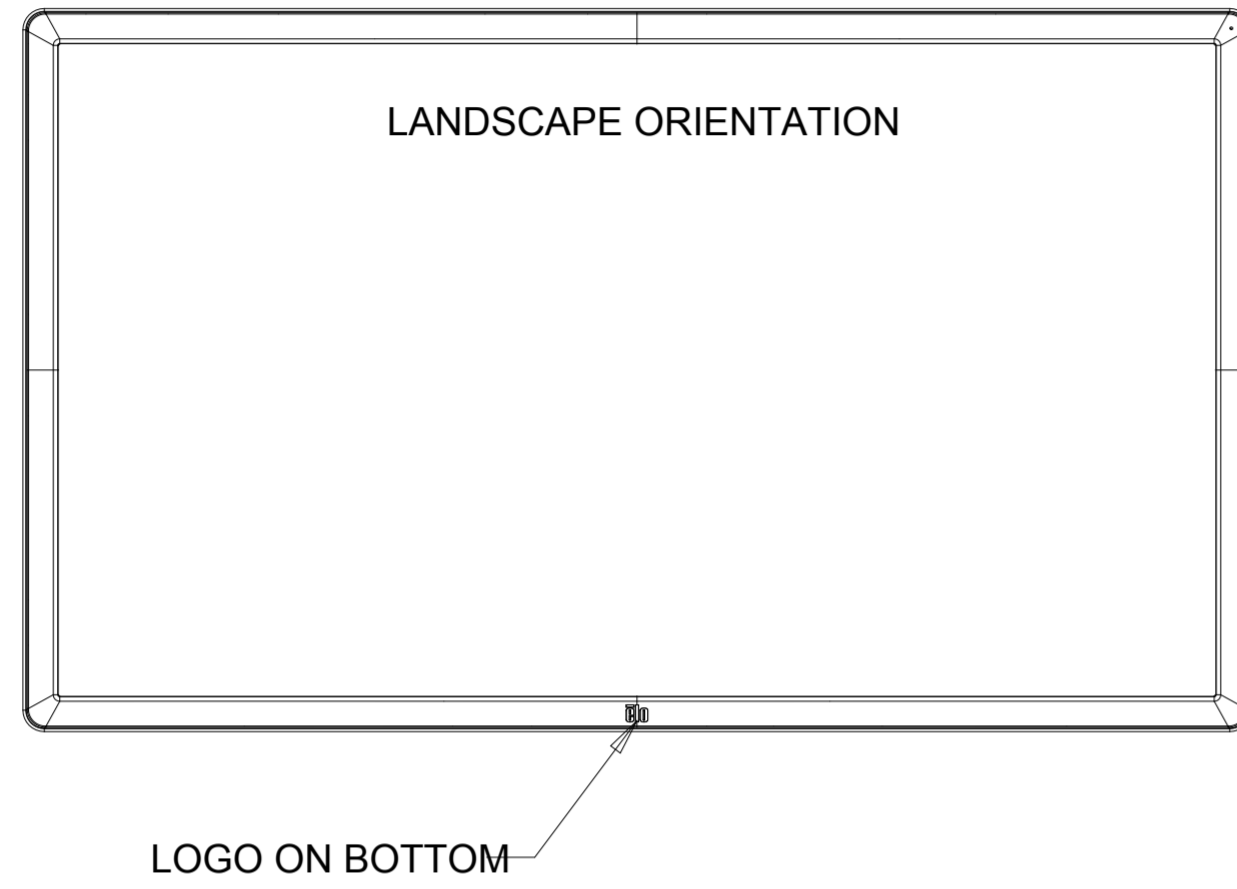

MOUNTING HOLE LOCATIONS FOR
 OPTIONAL LOW PROFILE WALLMOUNT KIT P/N E275050

LANDSCAPE ORIENTATION

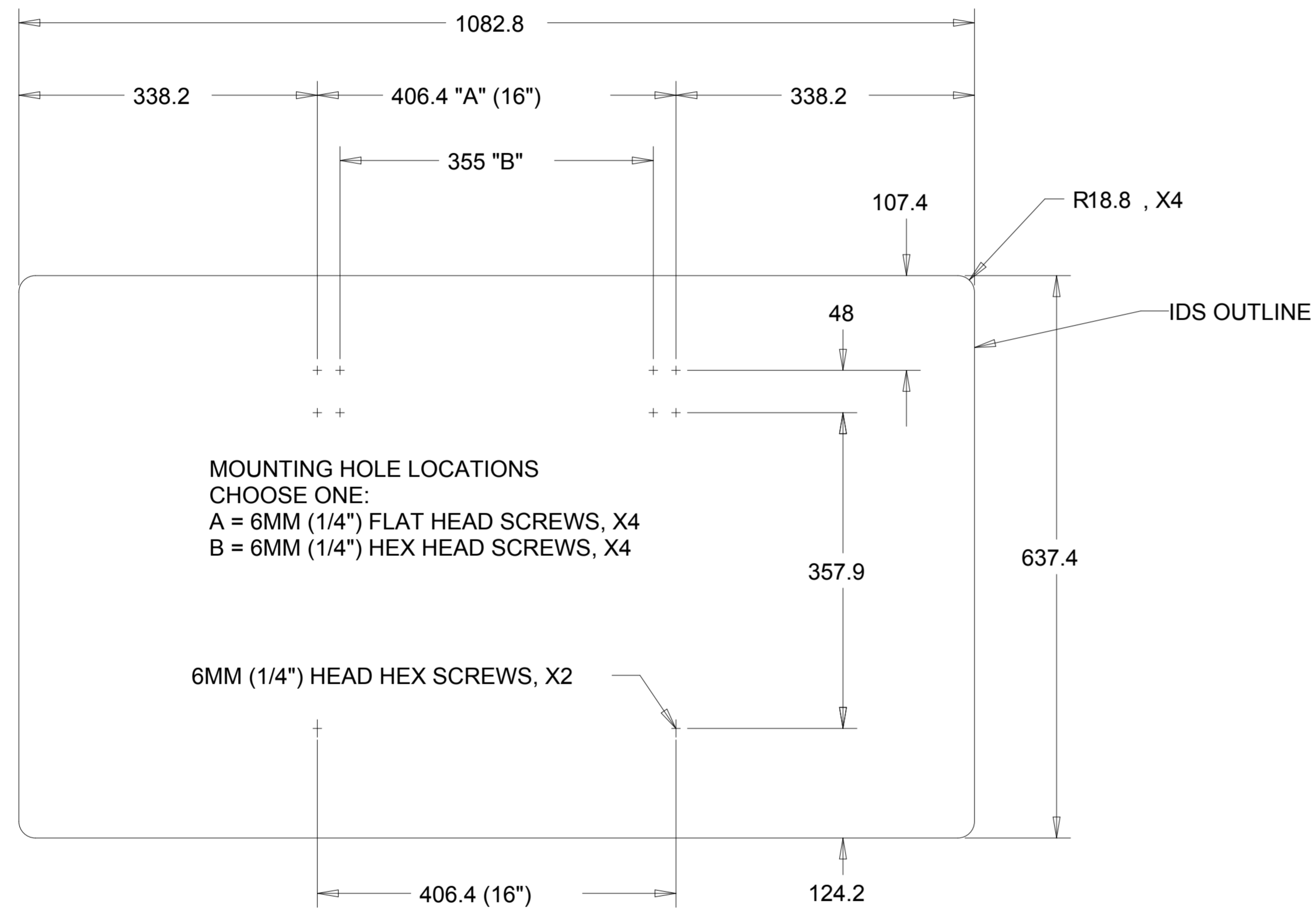

PORTRAIT ORIENTATION

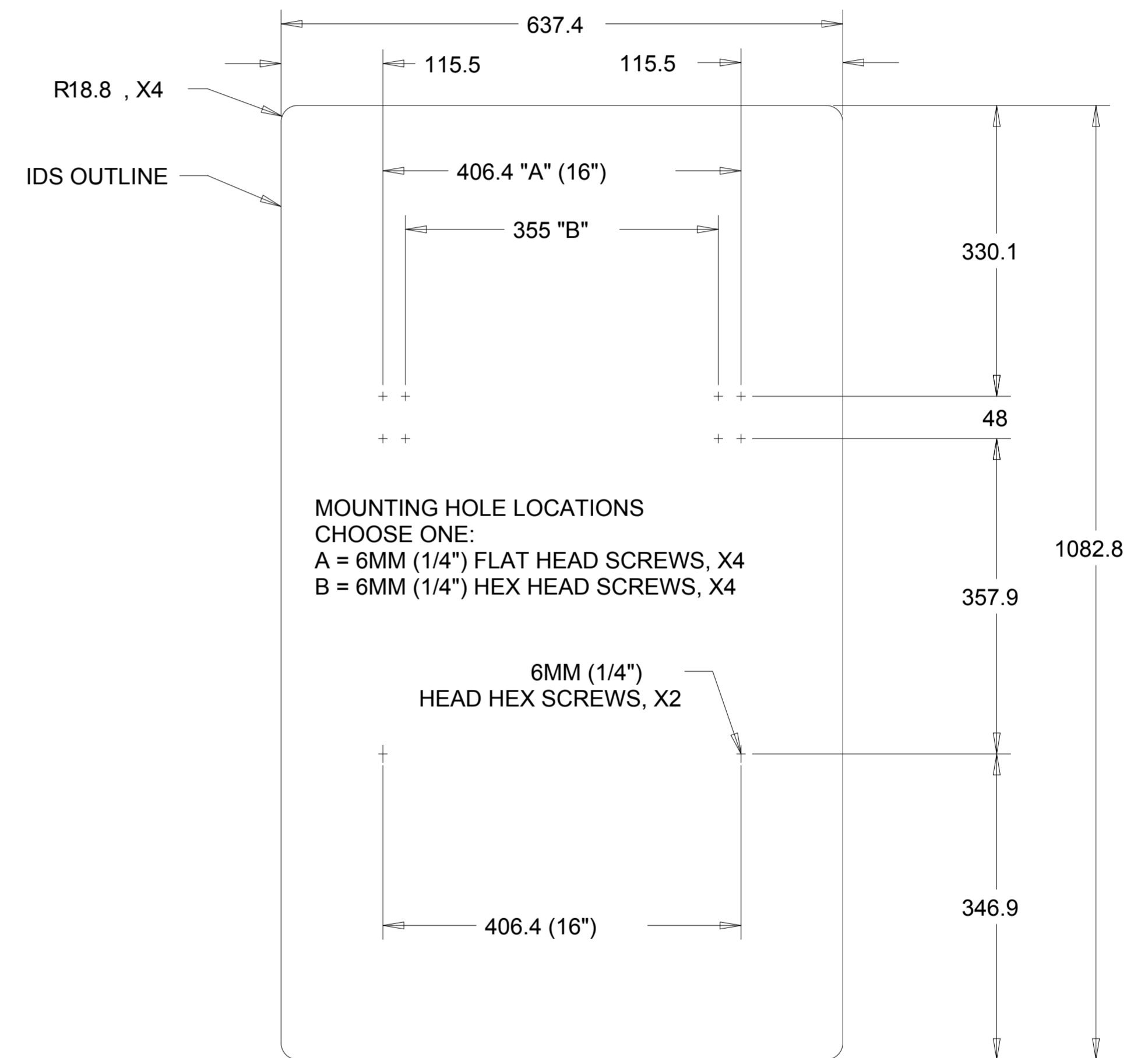

OPTIONAL SIDE MOUNT BRACKET KIT P/N E329508
4 ADJUSTABLE BRACKETS INCLUDED IN KIT
CUSTOMER ASSEMBLED

