

25-pin female / 25-pin male

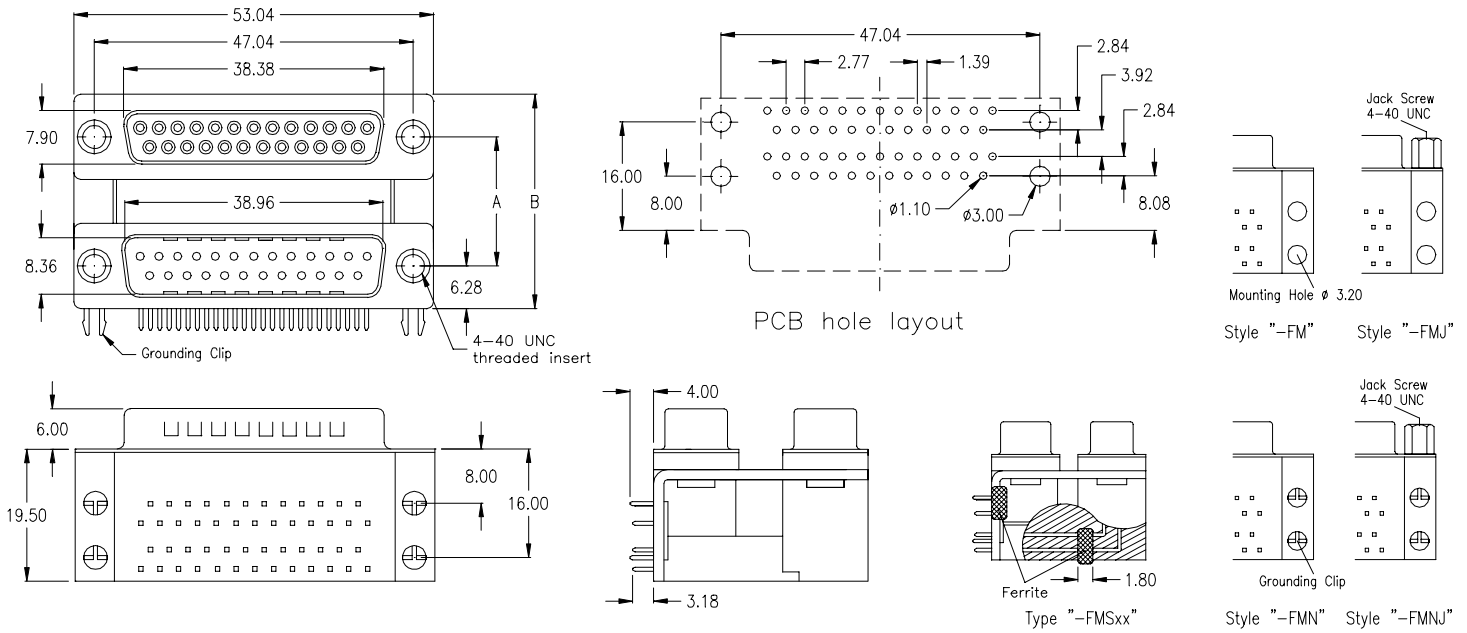

without grounding clips just 4 mounting holes	without grounding clips, just 4 mounting holes; 4 jack screws 4-40 UNC mounted	with 4 grounding clips (as above drawing)	with 4 grounding clips; 4 jack screws 4-40 UNC mounted	Distance Dimensions
SDD-2525-1-95-FM	SDD-2525-1-95-FMJ	SDD-2525-1-95-FMN	SDD-2525-1-95-FMNJ	„A“ = 22.86 „B“ = 35.41
SDD-2525-2-95-FM	SDD-2525-2-95-FMJ	SDD-2525-2-95-FMN	SDD-2525-2-95-FMNJ	„A“ = 19.05 „B“ = 31.60
SDD-2525-3-95-FM	SDD-2525-3-95-FMJ	SDD-2525-3-95-FMN	SDD-2525-3-95-FMNJ	„A“ = 15.87 „B“ = 28.42
if with Ferrite Filter: -FMS	if with Ferrite Filter: -FMSJ	if with Ferrite Filter: -FMSN	if with Ferrite Filter: -FMSNJ	

25-pin male / 25-pin female

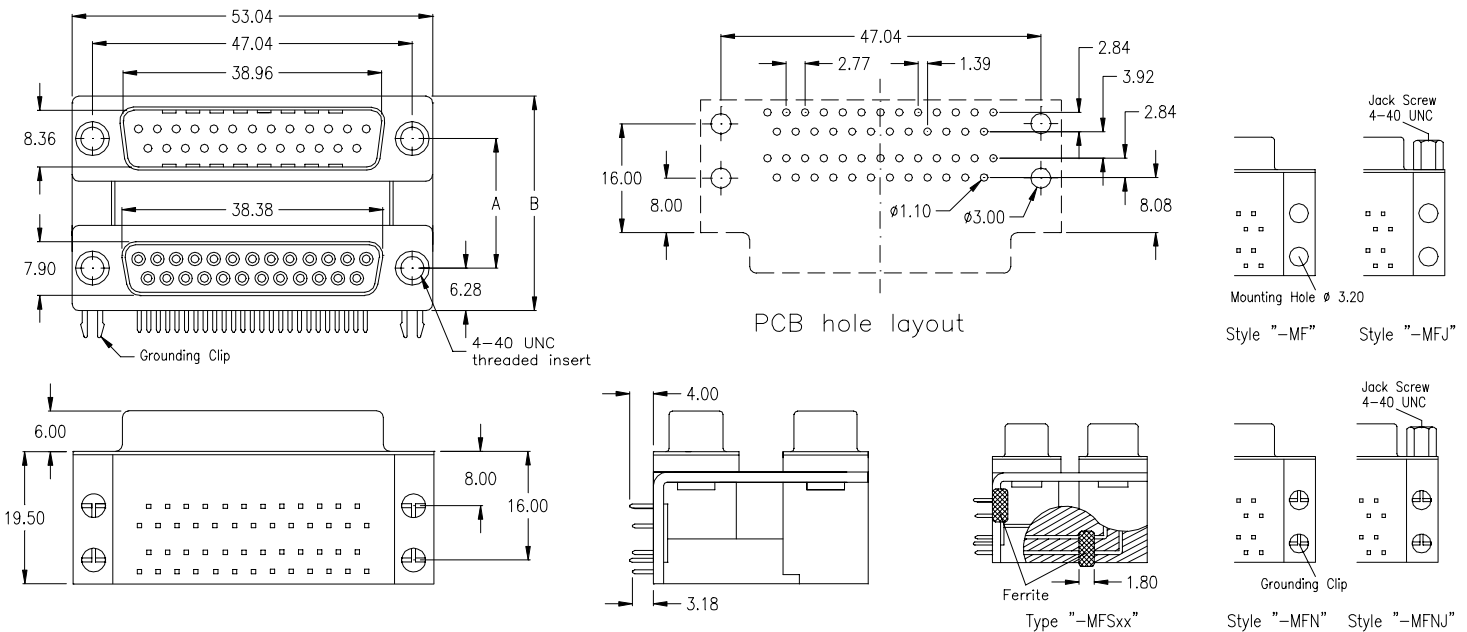

without grounding clips just 4 mounting holes	without grounding clips, just 4 mounting holes; 4 jack screws 4-40 UNC mounted	with 4 grounding clips (as above drawing)	with 4 grounding clips; 4 jack screws 4-40 UNC mounted	Distance Dimensions
SDD-2525-1-95-MF	SDD-2525-1-95-MFJ	SDD-2525-1-95-MFN	SDD-2525-1-95-MFNJ	„A“ = 22.86 „B“ = 35.41
SDD-2525-2-95-MF	SDD-2525-2-95-MFJ	SDD-2525-2-95-MFN	SDD-2525-2-95-MFNJ	„A“ = 19.05 „B“ = 31.60
SDD-2525-3-95-MF	SDD-2525-3-95-MFJ	SDD-2525-3-95-MFN	SDD-2525-3-95-MFNJ	„A“ = 15.87 „B“ = 28.42
if with Ferrite Filter: -MFS	if with Ferrite Filter: -MFSJ	if with Ferrite Filter: -MFSN	if with Ferrite Filter: -MFSNJ	