

FABRIMEX

the company you trust



Standard



Customized

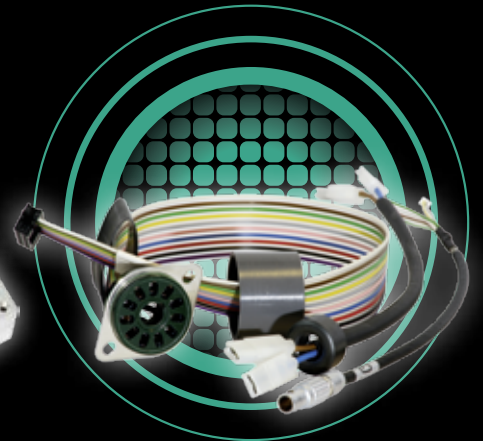

Cabling

Collection valid after November 2015

www.fabrimex.com

Power Supplies – the star behind the scenes in everyday life

Even if it doesn't receive any awards or design prizes, the power supply is the everyday star in our private and industrial environments. It performs its task, specifically providing a constant source of electricity to power virtually every area of contemporary life, doing so unobtrusively and as something we simply take for granted.

The fact is, high reliability in the supply of power is decisive in making certain our complex systems are always available. At Fabrimex, for many years it has been both a driving force and our passion to continually develop and perfect power supplies. For us, power supplies are the heart that provide the lifeblood for all electrical circuits. But what makes for a good power supply, and what are the features of a good brand? From a technical standpoint, today's power supplies are generally quite good across the board. As a result, various other developments are much more important in distinguishing among them; these include compact design (weight, size), efficiency (economical, ecological) and even reliability (long operating life).

We are proud of our products and our many years of expertise, and indeed to such a degree that we provide a 3-5-year guarantee on all our standard products. Place your trust in us.

Fabrimex – the company you trust!



Andreas Rüegg
Managing Director



Think globally – act locally

Fabrimex is a Swiss manufacturer and marketer of DC/DC converters, DC/DC regulators and AC/DC power supplies for industry in the small to mid-level power area with a focus on the range 1 to 600 watts. We supply customers in the automotive, transport, communication, consumer goods, laboratory and medical sectors. Typical applications are in control and monitoring systems, portable instruments and data-processing systems.

We are also active internationally with a global sales network and partnerships going back many years. In industrial electronics, we already established an excellent reputation back in the 1970s. Our company, with its long-standing tradition, has been doing its own development and manufacturing since 1977.

We know our customers’ needs precisely. We also realise that for maximum operating capabilities you need an optimal power supply, one which functions continuously and reliably over the longest possible time. Of course, all our products meet international norms and standards regarding safety and EMC.

Think globally – act locally. With our global sales network and relationships in the Far East spanning decades, combined with our local manufacturing and a firmly established R&D department which enjoys taking on all technical challenges, we are a reliable partner for our customers.

from page 6

from page 90

from page 92

Standard

Customized

Cabling

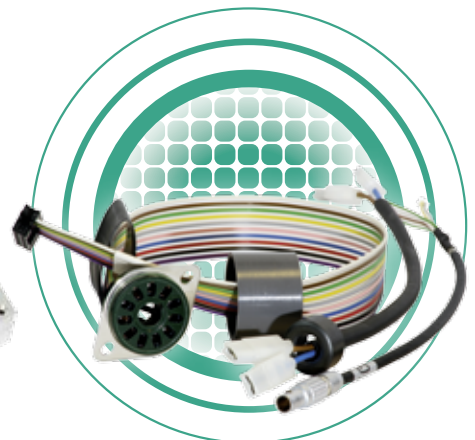
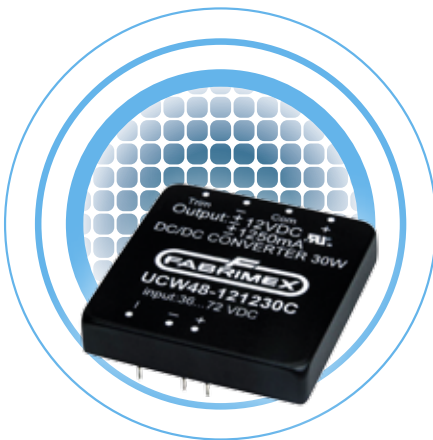

	SERIES	POWER	PAGE
Standard			6-7
LED PRODUCTS			8-13
LED Power Supply	LDP25	25 Watt Output	8
	LDP40	40 Watt Output	8
	LDP60	60 Watt Output	9
	CLD50D	50 Watt Dual Output	9
	LDA 100S	100 Watt	10
	LDA 150S	150 Watt	10
DC LED Driver	DIM01	DALI Interface Module	11
	DLD	57 Watt Buck LED Driver	11
	ALD	57 Watt Buck LED Driver	11
	MLD	Multi-Channel LED Driver	12
LED Light Controller	DRD-S1-A/DRD-S1-E/DRD-M1-A/DRD-M1-E/DTP-A	DALI	13
DC/DC Converter			14-63
Non Isolated	ERL 1.6 - 2A	0.7-3.0 Amp	14
	ERL 1.6 - 2A SMD	0.7-3.0 Amp	14
	SRL 1A	1 Amp	14
	SRL 2A	2.0 Amp	15
	SRL 3A	3.0 Amp	15
	ERS 5A, SIL-11	5.0 Amp	15
	ERS 5A SMD	5.0 Amp	16
	SRL 5A	5.0 Amp	16
	ERS-Series, SIL-11	10 Amp	16
	ERS-Series, SMD	10 Amp	17
	ERS-Series, SIL-11/SMD Adjustable	10 Amp	17
	ERW-Series, SIL-12/SMD	10 Amp	18
	ERS-Series, SIL-11/SMD	15 Amp	18
	ERS-Series, SIL-11/SMD	16 Amp	19
	ERW-Series, SIL-12/SMD	16 Amp	19
	ERW-Series, SIL-12/SMD	16 Amp	20
Converter Unregulated	SC-Series	1 Watt	21
	SC-Series, NST	1 Watt	21
	SC-Series, SMD	1 Watt	22
	SC-Series	2 Watt	22
Converter Regulated	EC-Series, DIL-24	1.5 Watt	23
	EC-Series, SMD	1.5 Watt	23
	SCW-Series, SIL-8	2 Watt	24
	ECU-Series, DIL-24	3 Watt	24
	ECU-Series, SMD	3 Watt	25
	ECW-Series, DIL-24 (Class A/Class B)	3 Watt	26
	ECW-Series, SMD	3 Watt	27
	SCU-Series	3 Watt	28
	SCW-Series, SIL-8	3 Watt	28
	UCW-Series, DIL-24 (Class A/Class B)	3 Watt	29
	ECU-Series, DIL-24 (Class A/Class B)	5-6 Watt	29
	ECU-Series, SMD	5-6 Watt	30
	ECW-Series, DIL-24	5-6 Watt	30
	ECW-Series, SMD	5-6 Watt	31
	HCW-Series, DIL-24	5-6 Watt	32
	HCW-Series, SMD	5-6 Watt	32
	UCW-Series, DIL-24 (Class A/Class B)	5-6 Watt	33
	ECW-Series, 2x1"	7.5 Watt	33
	ECW-Series, DIL-24	7.5 Watt	34
	ECW-Series, SMD	7.5 Watt	34
	ECU-Series	8 Watt	35
	ECU-Series, SMD	8 Watt	35
	ECU-Series	10 Watt	36
	ECU-Series, 1x1"	10 Watt	36
	ECW-Series	10 Watt	37
	ECW-Series, 1x1"	10 Watt	38
	ECW-Series, 1x1" SMD	10 Watt	39
	ECW-Series, DIL-24	10 Watt	40
	ECW-Series, SMD	10 Watt	40
	UCW-Series	10 Watt	41
	ECU-Series, 1x1"	15 Watt	41
	ECU-Series, 1x1" SMD	15 Watt	42
	ECU-Series, 2x2"	15 Watt	42
	ECW-Series, 1x1"	15 Watt	43
	ECW-Series, 1x1" SMD	15 Watt	43
	ECW-Series, 2x1"	15 Watt	44
	ECW-Series, 2x2"	15 Watt	44
	OCW-Series, 1x1"	15 Watt	45
	OCW-Series, 1x1" SMD	15 Watt	45

	OCW-Series, 2x1"	15 Watt	46
	UCU-Series, 2x2"	15 Watt	46
	UCW-Series, 2x1"	15 Watt	47
	ECU-Series	20 Watt	47
	ECU 'B'-Series	20 Watt	48
	ECW-Series	20 Watt	48
	ECW-Series, 2x1.6"	25 Watt	49
	OCW-Series	25 Watt	49
	ECU-Series	30 Watt	50
	ECW-Series	25-30 Watt	50
	ECW 'C'-Series	25-30 Watt	51
	ECW 'B'-Series	30 Watt	52
	UCW 'C'-Series	25-30 Watt	53
	ECW 'C'-Series	40 Watt	54
	ECU-Series	50 Watt	55
	ECW-Series	50 Watt	55
	ECU-Series	75 Watt	56
	ECW-Series	75 Watt	56
	EQU-Series	75 Watt	57
	EQW-Series	75 Watt	57
	ECU-Series	100 Watt	58
	ECW-Series	100 Watt	58
	EQU-Series	100 Watt	59
	ECU-Series	150 Watt	59
	ECW-Series	150 Watt	60
	ECU-Series	200 Watt	60
	ECW-Series	200 Watt	61
	ECW-Series	350 Watt	61
	ECW-Series	600 Watt	62
	VCU-Series	75 Watt	63
	UPS-Series	Vehicle UPS	63
	Vehicle Converter		
	AC/DC Power Supplies		64-79
	Open Frame		
	CFM-Series	5-6 Watt	64
	CFM-Series	10 Watt	64
	CFM-Series	15 Watt	64
	CFM-Series	20 Watt	65
	CFM-Series	40 Watt	65
	CFM-Series, Dual	40 Watt	65
	CFM-Series, Triple	40 Watt	66
	CFM-Series	60 Watt	66
	CFM-Series	100 Watt	67
	CFM-Series	200 Watt	67
	CFM-Series	350 Watt	67
	Open Frame Medical		
	CFM medical-Series	5-6 Watt	68
	CFM medical-Series	40 Watt	68
	CFM medical-Series	60 Watt	68
	CFM medical-Series	100 Watt	69
	CFM medical-Series	350 Watt	69
	Enclosed		
	CFM 750-Series	750 Watt	70
	CFM 1600-Series	1600 Watt	70
	Desktop		
	TRG36-Series	36 Watt	71
	TRG45-Series	45 Watt	71
	TRG70-Series	70 Watt	72
	TRG70E-Series	70 Watt	72
	TRG100A-Series	100 Watt	73
	TRG150A-Series	150 Watt	73
	Desktop Medical		
	TRG21-Series	21 Watt	74
	TR30M-Series	30 Watt	74
	TR60M-Series	60 Watt	75
	Wall Mount		
	TRG10R-Series	10 Watt	76
	TRG15-Series	15 Watt	76
	TRG15RA-Series	15 Watt	76
	TRG25-Series	25 Watt	77
	TRG30RAV-Series	30 Watt	77
	TRG30RV-Series	30 Watt	78
	Wall Mount Medical		
	TR15RAM-Series	15 Watt	79
	TR30RAM-Series	30 Watt	79
	AC ADAPTER PART NUMBER CONFIGURATION		80-81
	HEATSINKS		82-83
	PINNING		84-89
	Customized		90-91
	Cabling		92-93
	DISTRIBUTOR LIST		94-95

Standard

Successfully put to use – with a guarantee

Our well-engineered standard products have been put to use for many years and have proven themselves time and again, and this has made them exceptionally popular.

- DC/DC converters
- AC/DC power supplies

We supply customers in the automotive, transport, communication, consumer goods, laboratory, medical as well as aerospace and defence sectors. Typical applications are in control and monitoring systems, portable instruments and data-processing systems. Of course, our products meet international norms and standards regarding safety and EMC.

Fabrimex offers also a wide range of LED drivers, power supplies and DALI controllers to give you the ability to tailor your lightning system to exacting requirements.



Thanks the high reliability of all our standard products, we provide a **3-5-year guarantee** on every one of them.

YOUR BENEFITS AS OUR CUSTOMER ARE EXTENSIVE

Comprehensive

As a Swiss manufacturer and marketer of DC/DC converters, DC/DC regulators and AC/DC power supplies, Fabrimex offers a comprehensive product range:

- Regulated DC/DC converters
- Unregulated DC/DC converters
- Non-isolated DC/DC converters
- DC/DC converters for vehicles
- Programmable
- High voltage
- AC/DC adapters
- ATX AC/DC power supplies
- ATX medical AC/DC power supplies
- Desktop AC/DC power supplies
- Desktop medical AC/DC power supplies
- Enclosed AC/DC power supplies
- Open-frame AC/DC power supplies
- Open-frame medical AC/DC power supplies
- Wall-mount AC/DC power supplies
- Wall-mount medical AC/DC power supplies

Also exclusive at Fabrimex:
• GLASSMAN HIGH VOLTAGE INC.

Experienced

When it comes to industrial electronics, Fabrimex already established an excellent reputation back in the 1970s. Our company, with its long-standing tradition, has been doing its own development and manufacturing since 1977. We know our customers' needs precisely. We also realise that for maximum operating capabilities you need an optimal power supply, one which functions continuously and reliably over the longest possible time.

Certified

Our company is certified to DIN EN ISO9001:2008.



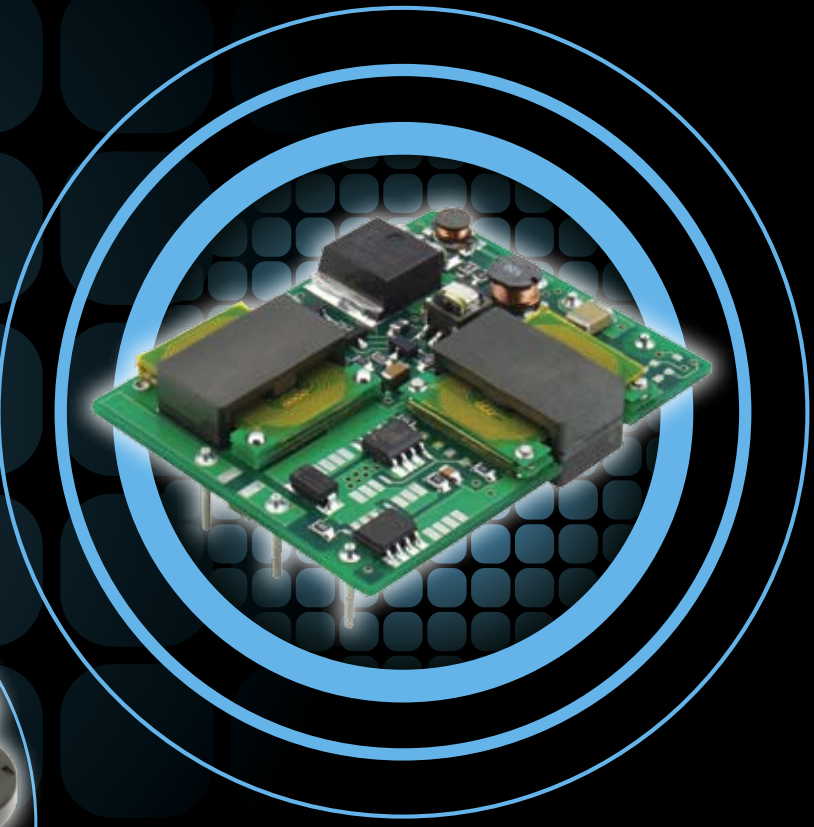

25 Watt Output

LDP25



- AC Input Range 90–305 VAC
- Constant Current Output
- Active PFC > 0.9
- Low Inrush Current < 5 A
- Low Profile, Height of 20 mm and Width of 30 mm
- Low Ripple and Noise
- Short Circuit / Over Voltage / Over Temperature Protection
- Fully Isolated Plastic Case
- Safety UL8750, IEC/EN61347-1, IEC/EN61347-2-13
- IP 67 (Optional)
- Dimming Function: 1-10 V / PWM (Optional)
- **Dimensions (L x W x H):** 140 x 30 x 20 mm



LDP Series	Output Power	ID Code	Out Voltage	ID Code	Output Current (set when ordering)	Input Voltage	ID Code
LDP	25	X S: Single O/P A: Single O/P with IP 67	X 240 : 24 V 360 : 36 V 480 : 48 V	X C: No dimming P: with PWM 1-10 V dimming	X 110 : 1100 mA 070 : 700 mA 053 : 530 mA	X A: 100-240 VAC labelled B: 100-277 VAC labelled	X R: 1% output ripple or Blank: 10% output ripple

Model	Input Voltage Range	Output Rated Voltage	Output Rated Current	No load Output Voltage	Output Rated Power	Ripple and Noise	% Eff. Typ.
Single Output	VAC	VDC	mA	VDC	W	Vpp	%
LDP25S240-xxxxxx	90-264/305 ¹	9/16-24 ³	1100	29	26.4	0.24/2.0 ³	86
LDP25S360-xxxxxx	90-264/305 ¹	9/24-36 ³	700	43	25.2	0.36/2.7 ³	86
LDP25S480-xxxxxx	90-264/305 ¹	9/32-48 ³	530	56	25.44	0.48/4.8 ³	86

NOTE: 1. Nominal Input Voltage: 115 VAC, 230/277 VAC
LDP25XXXX-XXXXAX for 90–264 VAC
LDP25XXXX-XXXXBX for 90–305 VAC

2. Ripple and Noise are measured at 20 MHz bandwidth with a 0.1 uF ceramic capacitor and 10 uF aluminum capacitor.

3. LDP25XXXX-XXXXXR for the models with Low Ripple: Vout min 9V Typ.
Ripple Noise = Max Output Rated Voltage * 1% (Vpp) Eff. = 84% Typ.

40 Watt Output

LDP40



- AC Input Range 90 – 305 VAC
- Constant Current Output
- Active PFC > 0.9
- Low Inrush Current < 5 A
- Low Profile, Height of 25.4 mm and Width of 40 mm
- Low Ripple and Noise
- Short Circuit / Over Voltage / Over Temperature Protection
- Fully Isolated Plastic Case
- Safety UL8750, IEC/EN61347-1, IEC/EN61347-2-13
- IP 67 (Optional)
- Dimming Function: 1-10 V / PWM / DALI (Optional)
- **Dimensions (L x W x H):** 168 x 40 x 25.2 mm



LDP Series	Output Power	ID Code	Out Voltage	ID Code	Output Current (set when ordering)	Input Voltage	ID Code
LDP	40	X S: Single O/P A: Single O/P with IP 67 D: Dual O/P B: Dual O/P with IP 67	X 240 : 24 V 360 : 36 V 480 : 48 V	X C: No dimming D: with DALI dimming P: with PWM dimming 1-10 V/potentiometer	X 170 : 1700 mA 084 : 840 mA	X A: 100-240 VAC labelled B: 100-277 VAC labelled	X R: 1% output ripple or Blank: 10% output ripple

Model	Input Voltage Range	Output Rated Voltage	Output Rated Current	No load Output Voltage	Output Rated Power	Ripple and Noise	% Eff. Typ.
Single Output	VAC	VDC	mA	VDC	W	Vpp	%
LDP40S240-xxxxxx	100-240/277 ¹	9/16-24 ³	1700	29	40.8	0.24/2.0 ³	86
LDP40S480-xxxxxx	100-240/277 ¹	9/32-48 ³	840	56	40.32	0.48/4.8 ³	86

NOTE: 1. Nominal Input Voltage: 115 VAC, 230/277 VAC
LDP40XXXX-XXXXAX for 90–264 VAC Input (100–240 VAC labelled)
LDP40XXXX-XXXXBX for 90–305 VAC Input (100–277 VAC labelled)

2. Ripple and Noise are measured at 20 MHz bandwidth with a 0.1 uF ceramic capacitor and 10 uF aluminum capacitor.

3. LDP40XXXX-XXXXXR for the models with Low Ripple: Vout min 9V Typ.
Ripple Noise = Max Output Rated Voltage * 1% (Vpp) Eff. = 84% Typ.

60 Watt Output

LDP60



- AC Input Range 90–305 VAC
- 30 W Dual Outputs / 60 W Single Output By Paralleling
- Constant Current Output
- Active PFC > 0.9
- Low Inrush Current < 5 A
- Low Profile, Height of 25.4 mm and Width of 40 mm
- Low Ripple and Noise
- Short Circuit / Over Voltage / Over Temperature Protection
- Fully Isolated Plastic Case
- Safety UL8750, IEC/EN61347-1, IEC/EN61347-2-13
- IP 67 (Optional)
- Dimming Function: 1-10 V / PWM / DALI (Optional)

• Dimensions (L x W x H):
262 x 40 x 25.4 mm



LDP Series	Output Power	ID Code	Out Voltage	ID Code	Output Current (set when ordering)	Input Voltage	ID Code
LDP	60	X	X	X	X	X	X
		S: Single O/P A: Single O/P with IP 67 D: Dual O/P B: Dual O/P with IP 67	240 : 24 V 360 : 36 V 480 : 48 V	C: No dimming D: with DALI dimming P: with PWM dimming 1-10 V / Po-tentiometer	062 : 625 mA 083 : 833 mA 125 : 1250 mA 166 : 1666 mA 250 : 2500 mA	A: 100-240 VAC labelled B: 100-277 VAC labelled	R: 1 % out-put ripple or Blank: 10 % output ripple

Model	Input Voltage Range	Output Rated Voltage	Output Rated Current	No load Output Voltage	Output Rated Power	Ripple and Noise	% Eff. Typ.
Single Output	VAC	VDC	mA	VDC	W	Vpp	%
LDP60D240-XXXXXX	90-264/305 ¹	9/16-24 ³	V1 1250 V2 1250	29	30	0.24/2.2 ³	86
LDP60D360-XXXXXX	90-264/305 ¹	9/24-36 ³	V1 833 V2 833	43	30	0.36/2.7 ³	86
LDP60D480-XXXXXX	90-264/305 ¹	9/32-48 ³	V1 625 V1 625	56	30	0.48/4.8 ³	86
LDP60S240-XXXXXX	90-264/305 ¹	9/16-24 ³	2500	29	60	0.24/2.2 ³	86
LDP60S360-XXXXXX	90-264/305 ¹	9/24-36 ³	1666	43	60	0.36/2.7 ³	86
LDP60S480-XXXXXX	90-264/305 ¹	9/32-48 ³	1250	56	60	0.48/4.8 ³	86

NOTE: 1. Nominal Input Voltage: 115 VAC, 230/277 VAC
LDP60XXXX-XXXXAX for the models 90–264 VAC Input (100–240 VAC labelled)
LDP40XXXX-XXXXBX for the models 90–305 VAC Input (100–277 VAC labelled)

2. Ripple and Noise are measured at 20 MHz bandwidth with a 0.1 uF ceramic capacitor and 10 uF aluminum capacitor.

3. LDP40XXXX-XXXXXR for the models with Low Ripple: Vout min 9 V Typ. Ripple Noise = Max Output Rated Voltage * 1 % (Vpp) Eff. = 84 % Typ.

50 Watt Dual Output

CLD50D



- AC Input Range 90–264 VAC
- Constant Current Output
- Active PFC > 0.9
- Low Inrush Current < 5 A
- Low Profile, Height of 24.5 mm and Width of 36.1 mm
- Low Ripple and Noise
- Short Circuit / Over Voltage Protection
- Fully Isolated Plastic Case
- Safety UL8750, IEC/EN61347-1, IEC/EN61347-2-13 and PSE Mark

• Dimensions (L x W x H):
300 x 36.1 x 24.5 mm



Model	Input Voltage Range	Output Rated Voltage	Output Rated Current	Output Rated Power	Output Voltage Maximum	Ripple and Noise (max.) Note 2	Efficiency Typical Note 3
Single Output	VAC	VDC	mA	W	W	Vpp	%
LDP40S240-xxxxxx	90-264	V1 8-24 V2 8-24	1000	24	30	300	85
LDP40S480-xxxxxx	90-264	V1 18-42 V2 18-42	600	25.2	48	300	85

NOTE: 1. Nominal Input Voltage: 100 VAC, 230 VAC
2. Ripple and Noise are measured at rated current, 100 VAC, Vo = 36 VDC (CLD50D420), 21 V (CLD50D240) and 20 MHz bandwidth with a 0.1 uF ceramic capacitor.
3. Measured at rated current, 100 VAC, Vo = 36 VDC (CLD50D420), 21 VDC (CLD50D240)

100 Watt Single Output

LDA100S



- AC Input Range 90 – 305 VAC
- Active PFC Function
- Short Circuit / Over Voltage / Over Current / Over Temperature Protection
- Safety UL8750, IEC/EN61347-1, IEC/EN61347-2-13
- IP 67
- Dimming Function: 1-10V / Resistance / PWM / DALI (Optional)
- Dimming Input Range 1 – 100 %
- 5 Years Warranty



Model	Output Voltage	Rated Current	Ripple and Noise Note 1	Voltage Accuracy Note 2	Line Regulation Note 4	Load Regulation	Constant Current Region	Efficiency Note 5
Single Output	V	A	%	%	%	V _{pp}	V	%
LDA100S24	24	4.16	1	±1	±1	±2	18-24	90
LDA100S36	36	2.77	1	±1	±1	±2	27-36	91
LDA100S48	48	2.08	1	±1	±1	±2	36-48	91
LDA100S60	60	1.66	1	±1	±1	±2	48-60	92
LDA100S107	107	0.93	1	±1	±1	±2	75-107	92
LDA100S142	142	0.70	1	±1	±1	±2	107-142	92
LDA100S214	214	0.47	1	±1	±1	±2	150-214	92

150 Watt Single Output

LDA150S



- AC Input Range 90 – 305 VAC
- Active PFC Function
- Short Circuit / Over Voltage / Over Current / Over Temperature Protection
- Safety UL8750, IEC/EN61347-1 IEC/EN61347-2-13
- IP 67
- Dimming Function: 1-10V / Resistance / PWM / DALI (Optional)
- Dimming Input Range 1 – 100 %
- 5 Years Warranty



Model	Output Voltage	Rated Current	Ripple and Noise Note 1	Voltage Accuracy Note 2	Line Regulation Note 4	Load Regulation	Constant Current Region	Efficiency Note 5
Single Output	V	A	%	%	%	V _{pp}	V	%
LDA150S240	24	6.25	1	±1	±1	±2	18-24	90
LDA150S480	48	3.125	1	±1	±1	±2	36-48	91
LDA150S107	107	1.4	1	±1	±1	±2	75-107	91
LDA150S142	142	1.05	1	±1	±1	±2	107-142	92
LDA150S214	214	0.7	1	±1	±1	±2	150-214	92

DALI Interface Module

DIM01



- For DALI systems
- Provides Two Sets of LED Lighting Synchronization Controls
- Adjustable Output Current
- Waterproof Design
- **Dimensions (L x W x H):**
84 x 48 x 17.8 mm



Model	Input Voltage Range Note 1	Output Operating Voltage Note 1	Output Rated Current	Output Rated Power (max.)	Ripple and Noise (max.) Note 5	Efficiency Typical Note 6
	VDC	VDC	mA	W	V _{pp}	%
DIM01L	12-30	Vout 1=10-28 Vout 2=10-28	1000 or 700 or 550 Note 7	28	500	95
DIM01H	12-60	Vout 1=10-58 Vout 2=10-58	700 or 550 or 350 Note 7	40.6	500	95
DIM01H100W	12-60	Vout 1=10-58 Vout 2=10-58	1000	58	500	95
DIM01H070W	12-60	Vout 1=10-58 Vout 2=10-58	700	40.6	500	95
DIM01H055W	12-60	Vout 1=10-58 Vout 2=10-58	550	31.9	500	95
DIM01H035W	12-60	Vout 1=10-58 Vout 2=10-58	350	20.3	500	95

NOTE: 1. Nominal Input Voltage: 48 VDC (DIM01H), 24 VDC (DIM01L) Nominal output Voltage: 36 VDC (DIM01H), 12 VDC (DIM01L)
5. Ripple and Noise are measured at rated current, Nominal Input and Nominal output And 20 MHz bandwidth with a 0.1uF ceramic capacitor.
6. Measured at rated current, Nominal Input and Nominal output.

Specifications are subject to change without notice

57 Watt Buck LED Driver

DLD



- Output Rated Current from 350 – 1400 mA
- Constant Current Output
- DIP16 Package/Wire End
- IP 67
- Short Circuit Protection
- Dimming Function: 1-10 V / PWM / DALI (Optional)
- **Dimensions (L x W x H):**
32.5 x 16.8 x 10.1 mm



Model Number	Input Voltage Range	Output Operating Voltage	Output Rated Current	Output Rated Power	Ripple and Noise (max.) Note 2	Efficiency Typical Note 3
	VDC	VDC	mA	W	V _{pp}	%
DLD-C035	4.5-60	2-57	350	20	300	96
DLD-C070	4.5-60	2-57	700	40	500	96
DLD-C100	4.5-60	2-57	1000	57	500	96
DLD-C140	10-36	8-33	1400	46.2	500	96

NOTE: 1. $3 V < V_{in} - V_{out} < 30$ VDC, to keep current accuracy. Nominal Input Voltage: 48 VDC, 28 VDC (C140 models)
2. Ripple and Noise are measured at rated current, Nominal Input and 36 VDC or 24 VDC (C140 models) output and 20 MHz bandwidth with a 0.1 uF ceramic capacitor.
3. Measured at rated current, Nominal Input and 36 VDC or 24 VDC (C140 models) output

57 Watt Buck LED Driver

ALD



- For DALI Systems
- Constant Current Output
- Output Rated Current from 350 mA – 1'400 mA
- DIP24 Package
- IP 67
- Short Circuit Protection
- **Dimensions (L x W x H):**
31.8 x 20.3 x 12.7 mm



Model	Input Voltage Range	Output Operating Voltage	Output Rated Current	Output Rated Power	Ripple and Noise (max.) Note 2	Efficiency Typical Note 3
	VDC	VDC	mA	W	V _{pp}	%
ALD-C035	4.5-60	2-57	350	20	300	96
ALD-C070	4.5-60	2-57	700	40	500	96
ALD-C100	4.5-60	2-57	1000	57	300	96
ALD-C140	10-36	8-33	1400	46.2	500	96

NOTE: 1. $3 V < V_{in} - V_{out} < 30$ VDC, to keep current accuracy. Nominal Input Voltage: 48 VDC, 28 VDC (C140 models)
2. Ripple and Noise are measured at rated current, Nominal Input and 36 VDC or 24 VDC (C140 models) output and 20 MHz bandwidth with a 0.1 uF ceramic capacitor.
3. Measured at rated current, Nominal Input and 36 VDC or 24 VDC (C140 models) output

Multi-Channel LED DRIVER

MLD



- For DALI Systems
- Input Range 10 – 36 VDC & 4.5 – 60 VDC
- Output Rated Current from 700 mA – 1400 mA
- Provides Multi-Channels of LED Lighting Synchronization Controls
- Dimming Function: PWM
- Auxiliary Power for DALI Dimmers (Optional)
- **Dimensions (L x W x H):**
128.3 x 58.4 x 20.3 mm



Model	Input Voltage Range	Output Operating Voltage	Output Rated Current	Output Rated Power/Channel	Ripple and Noise (max.) Note 2	Efficiency Typical Note 3
	VDC	VDC	mA	W	Vpp	%
MLD4-C070	4.5-60	2-54 x 4	700 x 4	40	500	96
MLD4-C100	4.5-60	2-57 x 4	1000 x 4	57	500	96
MLD4-C140	10-36	8-33 x 4	1400 x 4	46.2	500	96
MLD6-C070	4.5-60	2-54 x 6	700 x 6	40	500	96
MLD6-C100	4.5-60	2-57 x 6	1000 x 6	57	500	96
MLD6-C140	10-36	8-33 x 6	1400 x 6	46.2	500	96

NOTE: 1. Nominal Input Voltage: 100 VAC, 230 VAC

2. Ripple and Noise are measured at rated current, 100 VAC, $V_o = 36$ VDC (CLD50D420), 21 V (CLD50D240) and 20 MHz bandwidth with a 0.1 μ F ceramic capacitor.3. Measured at rated current, 100 VAC, $V_o = 36$ VDC (CLD50D420), 21 VDC (CLD50D240)

DALI Digital Rotary Dimmer

DRD-S1-A



- For DALI systems
- On/Off switchable function
- Green LED locator light
- Designed as master controller or slave controller
- DRD-S1 serves as master controller and power supply for 2 slave controllers
- Automatic synchronization makes it possible to change the control location without disturbing effects (Brightness/ONOFF)
- Capable of individually addressing (1–64 addresses) or Broadcast mode
- **Dimensions (L x W x H): 120 x 70 x 48.2 mm**



DALI Digital Rotary Dimmer

DRD-S1-E



- Input Voltage: 18 V ~ 20 V
- Minimum Watt: 3 W
- Output Current: 150 mA max.
- Maximum length of signal line: 300 m
- Operating Temperature: 0 ~ 50 °C
- DRD-S1-E Connection:
 1. Active DRD-S1-E*1 Max connection: 45 Ballast or LED Device
 2. Active DRD-S1-E*2 Max connection: 90 Ballast or LED Device
 3. Active DRD-S1-E*1 Max connection: 2 Passive DRD-S1-E
 4. Active DRD-S1-E*2 Max connection: 4 Passive DRD-S1-E
- **Dimensions (L x W x H): 81 x 81 x 48.3 mm**



DALI Multiple Dimmer

DRD-M1-A



- For DALI systems
- On/Off switchable function
- Green LED locator light
- DRD-M1 serves as master controller and power supply for 2 DRD-S1 slave controllers
- Automatic synchronization makes it possible to change the control location without disturbing effects (Brightness/ONOFF)
- 1–6 Individual DALI addresses can be addressed and controlled independently
- Recall and store up to 6 lighting scenes
- Readdressing of individual DALI addresses possible
- **Dimensions (L x W x H): 120 x 70 x 52.3 mm**



DALI Multiple Dimmer

DRD-M1-E



- For DALI systems
- On/Off switchable function
- DRD-M1 serves as master controller and power supply for 2 DRD-S1 slave controllers
- Automatic synchronization makes it possible to change the control location without disturbing effects (Brightness/ONOFF)
- 1–4 Individual DALI addresses can be addressed and controlled independently
- Recall and store up to 4 lighting scenes
- Readdressing of individual DALI addresses possible
- **Dimensions (L x W x H): 81 x 81 x 34.1 mm**



DALI Touch panel controller

DTP-A



- For DALI systems
- On/Off switchable function
- DTP-A serves as master controller and power supply for 2 DRD-S1 slave controllers
- Automatic synchronization makes it possible to change the control location without disturbing effects (Brightness/ONOFF)
- 1–6 Individual DALI addresses can be addressed and controlled independently
- Recall and store up to 4 lighting scenes
- Readdressing of individual DALI addresses possible
- 2.8" LCD display



0.7-3.0 Amp**ERL 1.6 - 2A****2:1 input voltage range DC/DC converters without galvanic isolation**

- No input/output isolation
- High reliability
- High efficiency up to 94 %
- No derating up to 71 °C
- Pi-filter at input
- Over current protection
- Metal case with non conductive base plate, six sides shielded or non conductive plastic case
- **Dimensions (L x W x H): 32 x 20 x 10.2 mm**

Model	Uin	Uout	Iout	No load	η typ.	Ripple	Pinning
Single Output	VDC	VDC	mA	mA	%	mVpp	
ERL0510-10	9.0...32.0	5.0	2000	15	88	100	A8
ERL1210-10	9.0...32.0	12.0	830	15	87	120	A8
ERL1220-10	16.0...32.0	12.0	1600	15	93	120	A8
ERL1510-10	9.0...32.0	12.0	666	15	87	150	A8
ERL1524-10	19.0...32.0	15.0	1600	15	94	150	A8
ERL3V307-10	4.7...6.0	3.3	2000	15	85	100	A8
ERL3V307-10	9.0...32.0	3.3	2000	15	84	100	A8

0.7-3.0 Amp**ERL 1.6 - 2A SMD****2:1 input voltage range DC/DC converters without galvanic isolation**

- No input/output isolation
- High reliability
- High efficiency up to 94 %
- No derating up to 71 °C
- Pi-filter at input
- Over current protection
- Metal case with non conductive base plate, six sides shielded or non conductive plastic case
- **Dimensions (L x W x H): 32 x 20 x 11.4 mm**

Model	Uin	Uout	Iout	No load	η typ.	Ripple	Pinning
Single Output	VDC	VDC	mA	mA	%	mVpp	
ERL1510-10-S	9.0...32.0	12.0	666	15	87	150	AS8
ERL1210-10-S	9.0...32.0	12.0	830	15	87	120	AS8
ERL1220-10-S	16.0...32.0	12.0	1600	15	93	120	AS8
ERL1524-10-S	19.0...32.0	15.0	1600	15	94	150	AS8
ERL0510-10-S	9.0...32.0	5.0	2000	15	88	100	AS8
ERL3V307-10-S	4.7...6.0	3.3	2000	15	85	100	AS8
ERL3V307-10-S	9.0...32.0	3.3	2000	15	84	100	AS8

1 Amp**SRL 1A****Wide input voltage range DC/DC regulators without galvanic isolation**

- High efficiency up to 90 %
- High reliability
- Fast action feedback module
- No derating up to 71 °C
- Very low output ripple and noise
- Burn-in at full load
- EMC according to EN55022 class B
- **Dimensions (L x W x H): 32 x 20 x 12 mm**

Model	Uin	Uout	Iout	No load	η typ.	Ripple	Pinning
Single Output	VDC	VDC	mA	mA	%	mVpp	
SRL5005-12	7.0...40.0	5.1	1000	10	82	60	A1
SRL3303-12	4.8...40.0	3.3	1000	10	75	60	A1
SRL1515-12	17.0...40.0	15.0	1000	10	90	60	A1
SRL1212-12	14.0...40.0	12.0	1000	10	88	60	A1

2.0 Amp

SRL 2A



2:1 input voltage range DC/DC converters without galvanic isolation

- High efficiency up to 86 %
- High reliability
- Fast action feedback module
- No derating up to 71 °C
- Very low output ripple and noise
- Burn-in at full load
- EMC according to EN55022 class B
- **Dimensions (L x W x H): 32 x 20 x 12 mm**

Model	U _{in}	U _{out}	I _{out}	No load	η typ.	Ripple	Pinning
Single Output	VDC	VDC	mA	mA	%	mVpp	
SRL0306-12	8.0...40.0	3.3	2000	10	80	40	A1
SRL0510-12	8.0...40.0	5.1	2000	10	80	40	A1

3.0 Amp

SRL 3A



Wide input voltage range DC/DC regulators without galvanic isolation

- High efficiency up to 93 %
- High reliability
- Fast action feedback module
- No derating up to 71 °C
- Very low output ripple and noise
- Burn-in at full load
- EMC according to EN55022 class B
- **Dimensions (L x W x H): 50.8 x 25.4 x 10.2 mm**

Model	U _{in}	U _{out}	I _{out}	No load	η typ.	Ripple	Pinning
Single Output	VDC	VDC	mA	mA	%	mVpp	
SRL0310-S	8.0...40.0	3.3	3000	5	80	60	B1
SRL0515-S	8.0...40.0	5.1	3000	5	85	60	B1
SRL1236-S	15.0...40.0	12.0	3000	10	91	60	B1
SRL1545-S	18.0...40.0	15.0	3000	15	93	60	B1

5.0 Amp

ERS 5A, SIL-11



Highly adjustable DC/DC modules without galvanic isolation

- POLA standard pinning
- High reliability
- High efficiency up to 94 %
- Continuous short circuit protection
- Over temperature protection
- Remote on/off control
- UL and cUL1950 certified
- **Dimensions (L x W x H): 22.9 x 10.16 x 5.6 mm**

Model	U _{in}	U _{out}	I _{out}	No load	η typ.	Ripple	Pinning
Single Output	VDC	VDC	A	mA	%	mVpp	
ERS05-3V317A	3.0...5.5	0.75-3.63	5	35	94	50	S9-1
ERS12-0525A	8.3...14.0	0.75-5.00	5	45	92	75	S9-1

5.0 Amp**ERS 5A SMD****Highly adjustable DC/DC modules without galvanic isolation**

- POLA standard pinning
- High reliability
- High efficiency up to 94 %
- Continuous short circuit protection
- Over temperature protection
- Remote on/off control
- UL and cUL1950 certified
- **Dimensions (L x W x H): 20.3 x 11.43 x 6.09 mm**

Model	U _{in}	U _{out}	I _{out}	No load	η typ.	Ripple	Pinning
Single Output	VDC	VDC	A	mA	%	mVpp	
ERS05-3V317A-S	3.0...5.5	0.75-3.63	5	35	94	50	P-SMD2
ERS12-0525A-S	8.3...14.0	0.75-5.00	5	45	92	75	P-SMD2

5.0 Amp**SRL 5A****Wide input voltage range DC/DC regulators without galvanic isolation**

- With Inhibit and adjustment pins (Suffix "S2")
- High efficiency up to 93 %
- High reliability
- Fast action feedback module
- No derating up to 71 °C
- Very low output ripple and noise
- Burn-in at full load
- EMC according to EN55022 class B
- **Dimensions (L x W x H): 70 x 50 x 22 mm**

Model	U _{in}	U _{out}	I _{out}	No load	η typ.	Ripple	Pinning
Single Output	VDC	VDC	A	mA	%	mVpp	
SRL0315-S	8.0...40.0	3.3	5	5	80	50	F1
SRL0315-S2	8.0...40.0	3.3	5	5	80	50	F2
SRL0525-S	8.0...40.0	5.1	5	5	85	50	F1
SRL0525-S2	8.0...40.0	5.1	5	5	85	50	F2
SRL1260-S	15.0...40.0	12.0	5	5	91	50	F1
SRL1260-S2	15.0...40.0	12.0	5	5	91	50	F2
SRL1575-S	18.0...40.0	15.0	5	15	93	50	F1
SRL1575-S2	18.0...40.0	15.0	5	15	93	50	F2

10.0 Amp**ERS-Series, SIL-11****Power-On-Point DC/DC modules without galvanic isolation**

- POLA standard pinning
- High reliability
- High efficiency up to 95 %
- Continuous short circuit protection
- Over temperature protection
- Remote on/off control
- Negative remote on/off logic optional
- UL and cUL1950 certified

- **Dimensions (L x W x H): 51 x 8 x 12.7 mm**



Model	U _{in}	U _{out}	I _{out}	No load	η typ.	Ripple	Pinning
Single Output	VDC	VDC	A	mA	%	mVpp	
ERS05-1V010	3.0...5.5	1.0	10	50	85	50	S11
ERS05-1V212	3.0...5.5	1.2	10	50	86	50	S11
ERS05-1V515	3.0...5.5	1.5	10	50	88	50	S11
ERS05-1V818	3.0...5.5	1.8	10	50	90	50	S11
ERS05-2V020	3.0...5.5	2.0	10	50	91	50	S11
ERS05-2V525	3.0...5.5	2.5	10	60	93	50	S11
ERS05-3V333	4.5...5.5	3.3	10	60	95	50	S11
ERS12-0550	9.0...14.0	5.0	10	70	95	50	S11
ERS12-1V010	9.0...14.0	1.0	10	50	85	50	S11
ERS12-1V212	9.0...14.0	1.2	10	50	86	50	S11
ERS12-1V515	9.0...14.0	1.5	10	50	89	50	S11
ERS12-1V818	9.0...14.0	1.8	10	50	90	50	S11
ERS12-2V020	9.0...14.0	2.0	10	50	91	50	S11
ERS12-2V525	9.0...14.0	2.5	10	60	92	50	S11
ERS12-3V333	9.0...14.0	3.3	10	60	93	50	S11

Alternative: ERS...N N = negative remote on/off logic

10.0 Amp**ERS-Series, SMD****Power-On-Point DC/DC modules without galvanic isolation**

- POLA standard pinning
- High reliability
- High efficiency up to 95 %
- Continuous short circuit protection
- Over temperature protection
- Remote on/off control
- Negative remote on/off logic optional
- UL and cUL1950 certified

- **Dimensions (L x W x H):**
33 x 14 x 9.3 mm



Model	U _{in}	U _{out}	I _{out}	No load	η typ.	Ripple	Pinning
Single Output	VDC	VDC	A	mA	%	mVpp	
ERS05-1V010-S	3.0...5.5	1.0	10	50	85	50	P-SMD2
ERS05-1V212-S	3.0...5.5	1.2	10	50	86	50	P-SMD2
ERS05-1V515-S	3.0...5.5	1.5	10	50	88	50	P-SMD2
ERS05-1V818-S	3.0...5.5	1.8	10	50	90	50	P-SMD2
ERS05-2V020-S	3.0...5.5	2.0	10	50	91	50	P-SMD2
ERS05-2V525-S	3.0...5.5	2.5	10	60	93	50	P-SMD2
ERS05-3V333-S	4.5...5.5	3.3	10	60	95	50	P-SMD2
ERS12-0550-S	9.0...14.0	5.0	10	60	95	50	P-SMD2
ERS12-1V010-S	9.0...14.0	1.0	10	50	84	50	P-SMD2
ERS12-1V212-S	9.0...14.0	1.2	10	50	86	50	P-SMD2
ERS12-1V515-S	9.0...14.0	1.5	10	50	89	50	P-SMD2
ERS12-1V818-S	9.0...14.0	1.8	10	50	90	50	P-SMD2
ERS12-2V020-S	9.0...14.0	2.0	10	50	91	50	P-SMD2
ERS12-2V525-S	9.0...14.0	2.5	10	60	92	50	P-SMD2
ERS12-3V333-S	9.0...14.0	3.3	10	60	93	50	P-SMD2
Alternative:	ERS...-N	N = negative remote on/off logic					

10.0 Amp**ERS-Series, SIL-11/SMD Adjustable****Power-On-Point DC/DC modules without galvanic isolation**

- POLA standard pinning
- High reliability
- High efficiency up to 95 %
- Continuous short circuit protection
- Over temperature protection
- Remote on/off control
- Negative remote on/off logic optional
- UL and cUL1950 certified

- **Dimensions (L x W x H):**
33 x 14 x 9.3 mm



Model	U _{in}	U _{out}	I _{out}	No load	η typ.	Ripple	Pinning
Single Output	VDC	VDC	A	mA	%	mVpp	
ERS12-0550A	8.3...14.0	0.75-5.0	10	70	93	50	S11
ERS12-0550A-S	8.3...14.0	0.75-5.0	10	60	93	50	P-SMD2

10.0 Amp**ERW-Series, SIL-12/SMD****Power-On-Point DC/DC modules without galvanic isolation**

- POLA standard pinning
- High reliability
- High efficiency up to 95 %
- Wide output voltage range 0.75-5.0 VDC
- No derating up to 50 °C
- Continuous short circuit protection
- Over temperature protection
- Remote on/off control
- Negative on/off remote logic optional
- "Power Good" Signal
- UL and cUL1950 certified

- **Dimensions (L x W x H):**
SIL-12: 50.8 x 8.3 x 13 mm
SMD: 33 x 13.5 x 8.8 mm

Model	U _{in}	U _{out}	I _{out}	No load	η typ.	Ripple	Pinning
Single Output	VDC	VDC	A	mA	%	mVpp	
ERW12-0550A	6...14	0.75...5.0	10	40	95	75	S12
ERW12-0550A-S	6...14	0.75...5.0	10	40	95	75	P-SMD3

15.0 Amp**ERS-Series, SIL-11/SMD****Power-On-Point DC/DC modules without galvanic isolation**

- POLA standard pinning
- High reliability
- High efficiency of 94 %
- Continuous short circuit protection
- Over temperature protection
- Remote on/off control
- Negative on/off remote logic optional
- UL and cUL1950 certified

- **Dimensions (L x W x H):**
SIL-11: 51 x 8 x 12.7 mm
SMD: 33 x 13.5 x 9.3 mm

Model	U _{in}	U _{out}	I _{out}	No load	η typ.	Ripple	Pinning
Single Output	VDC	VDC	A	mA	%	mVpp	
ERS05-3V350	3.0...5.5	0.9...3.63	15	60	94	50	S11
ERS05-3V350-S	3...5.5	0.9...3.63	15	60	94	50	P-SMD2

16.0 Amp**ERS-Series, SIL-11/SMD****Surface mounted, power-on-point (POP®) DC/DC modules without galvanic separation**

- High efficiency up to 94 %
- Wide output voltage range 0.75 – 5.0 VDC
- No derating up to 30 °C ambient temperature
- Very low output ripple and noise
- Remote on/off control
- Short circuit protection
- Over temperature protection

- **Dimensions (L x W x H):**
SIL-11: 50.8 x 8.3 x 12.95 mm
SMD: 33 x 13.5 x 9.3 mm



Model	U _{in}	U _{out}	I _{out}	No load	η typ.	Ripple	Pinning
Single Output	VDC	VDC	A	mA	%	mVpp	
ERS12-0580A	9.0...14.0	0.75...5.0	16	95	94	75	S11
ERS12-0580A-S	9.0...14.0	0.75...5.0	16	95	94	75	P-SMD2
Alternative:	ERW...N	N = negative remote on/off logic					
	ERW...P	P = power good function					

16.0 Amp**ERW-Series, SIL-12/SMD****Power-On-Point DC/DC modules without galvanic isolation**

- POLA standard pinning
- High reliability
- High efficiency up to 94 %
- Wide output voltage range 0.75 – 5.0 VDC
- No derating up to 30 °C
- "Power Good" Signal
- Continuous short circuit protection
- Over temperature protection
- Remote on/off control
- UL and cUL1950 certified

- **Dimensions (L x W x H):**
SIL-12: 50.8 x 8.3 x 13 mm
SMD: 33 x 13.5 x 8.8 mm



Model	U _{in}	U _{out}	I _{out}	No load	η typ.	Ripple	Pinning
Single Output	VDC	VDC	A	mA	%	mVpp	
ERW12-0580A	6.0...14.0	0.75...5.0	16	95	94	75	S12
ERW12-0580A-S	6.0...14.0	0.75...5.0	16	95	94	75	P-SMD3
Alternative:	ERW...N	N = negative remote on/off logic					
	ERW...P	P = power good function					

20.0 Amp**ERW-Series, SIL-12/SMD****Power-On-Point DC/DC modules without galvanic isolation**

- POLA standard pinning
- High reliability
- High efficiency up to 94 %
- Wide output voltage range 0.75–5.0 VDC
- No derating up to 30 °C
- Continuous short circuit protection
- Over temperature protection
- Remote on/off control
- "Power Good" Signal
- UL and cUL1950 certified

Dimensions (L x W x H):**SIL-12: 61.0 x 8.3 x 13 mm****SMD: 43.2 x 13.5 x 9.3 mm**

Model	U _{in}	U _{out}	I _{out}	No load	η typ.	Ripple	Pinning
Single Output	VDC	VDC	A	mA	%	mVpp	
ERW12-05100A	6.0...14.0	0.75...5.0	20	95	94	75	S12
ERW12-05100A-S	6.0...14.0	0.75...5.0	20	95	94	75	P-SMD4
Alternative:	ERW...N	N = negative remote on/off logic					
	ERW...P	P = power good function					

1 Watt**SC-Series****Single inline, unregulated DC/DC modules**

- I/O isolation of 1'000 VDC
- 1 s short circuit protection
- **Dimensions (L x W x H): 19.5 x 6.1 x 10.2 mm**

Model	U _{in}	U _{out}	I _{out}	No load	η typ.	Ripple	Pinning
Single Output	VDC	VDC	mA	mA	%	mVpp	
SC05-0501NS	4.5...5.5	5.0	200	40	79	75	S7-1
SC05-1201NS	4.5...5.5	12.0	84	40	79	75	S7-1
SC05-1501NS	4.5...5.5	15.0	67	40	79	75	S7-1
SC12-0501NS	10.8...13.2	5.0	200	15	80	75	S7-1
SC12-1201NS	10.8...13.2	12.0	84	15	81	75	S7-1
SC12-1501NS	10.8...13.2	15.0	67	15	81	75	S7-1
SC24-0501NS	21.6...26.4	5.0	200	7	80	75	S7-1
SC24-1201NS	21.6...26.4	12.0	84	7	83	75	S7-1
SC24-1501NS	21.6...26.4	15.0	67	7	81	75	S7-1
Dual Output	VDC	VDC	mA	mA	%	mVpp	
SC05-0501ND	4.5...5.5	±5.0	±100	40	74	75	S7-5
SC05-1201ND	4.5...5.5	±12.0	±42	40	78	75	S7-5
SC05-1501ND	4.5...5.5	±15.0	±33	40	78	75	S7-5
SC12-0501ND	10.8...13.2	±5.0	±100	15	77	75	S7-5
SC12-1201ND	10.8...13.2	±12.0	±42	15	80	75	S7-5
SC12-1501ND	10.8...13.2	±15.0	±33	15	81	75	S7-5
SC24-0501ND	21.6...26.4	±5.0	±100	7	79	75	S7-5
SC24-1201ND	21.6...26.4	±12.0	±42	7	81	75	S7-5
SC24-1501ND	21.6...26.4	±15.0	±33	7	82	75	S7-5

Option: SC...-...NST SMD Pinning

1 Watt**SC-Series, NST****Single inline, unregulated DC/DC converter**

- I/O isolation of 1'000 VDC
- Multiple input voltages
- No derating up to 85 °C ambient temperature
- Industry standard pinout
- Short circuit protection 1 sec.
- **Dimensions (L x W x H): 11.6 x 6.0 x 10.2 mm**

Model	U _{in}	U _{out}	I _{out}	No load	η typ.	Ripple	Pinning
Single Output	VDC	VDC	mA	mA	%	mVpp	
SC05-0501NST	4.5...5.5	5.0	200	40	79	100	S4-1
SC05-1201NST	4.5...5.5	12.0	84	40	79	100	S4-1
SC05-1501NST	4.5...5.5	15.0	67	40	80	100	S4-1
SC12-0501NST	10.8...13.2	5.0	200	15	81	100	S4-1
SC12-1201NST	10.8...13.2	12.0	84	15	81	100	S4-1
SC12-1501NST	10.8...13.2	15.0	67	15	82	100	S4-1
SC24-0501NST	10.8...13.2	5.0	200	7	80	100	S4-1
SC24-1201NST	10.8...13.2	12.0	84	7	80	100	S4-1
SC24-1501NST	10.8...13.2	15.0	67	7	81	100	S4-1

1 Watt**SC-Series, SMD****Single inline, unregulated DC/DC modules**

- I/O isolation of 1'000 VDC
- 1 s short circuit protection
- **Dimensions (L x W x H):**
SMD single: 12.7 x 8.0 x 6.8 mm
SMD dual: 15.24 x 8.0 x 6.8 mm

Model	U _{in}	U _{out}	I _{out}	No load	η typ.	Ripple	Pinning
Single Output	VDC	VDC	mA	mA	%	mVpp	
SC05-0501NS-S	4.5...5.5	5.0	200	40	79	120	SMD8
SC05-1201NS-S	4.5...5.5	12.0	84	40	79	120	SMD8
SC05-1501NS-S	4.5...5.5	15.0	67	40	79	120	SMD8
SC12-0501NS-S	10.8...13.2	5.0	200	15	80	120	SMD8
SC12-1201NS-S	10.8...13.2	12.0	84	15	81	120	SMD8
SC12-1501NS-S	10.8...13.2	15.0	67	15	81	120	SMD8
SC24-0501NS-S	21.6...26.4	5.0	200	7	80	120	SMD8
SC24-1201NS-S	21.6...26.4	12.0	84	7	83	120	SMD8
SC24-1501NS-S	21.6...26.4	15.0	67	7	81	120	SMD8
Dual Output	VDC	VDC	mA	mA	%	mVpp	
SC05-0501ND-S	4.5...5.5	±5.0	±100	40	74	120	SMD10
SC05-1201ND-S	4.5...5.5	±12.0	±42	40	78	120	SMD10
SC05-1501ND-S	4.5...5.5	±15.0	±33	40	78	120	SMD10
SC12-0501ND-S	10.8...13.2	±5.0	±100	15	77	120	SMD10
SC12-1201ND-S	10.8...13.2	±12.0	±42	15	80	120	SMD10
SC12-1501ND-S	10.8...13.2	±15.0	±33	15	81	120	SMD10
SC24-0501ND-S	21.6...26.4	±5.0	±100	7	79	120	SMD10
SC24-1201ND-S	21.6...26.4	±12.0	±42	7	81	120	SMD10
SC24-1501ND-S	21.6...26.4	±15.0	±33	7	82	120	SMD10

2 Watt**SC-Series****Single inline, unregulated DC/DC modules**

- I/O isolation of 1'000 VDC
- 1 s short circuit protection
- **Dimensions (L x W x H): 19.5 x 6.1 x 10.2 mm**

Model	U _{in}	U _{out}	I _{out}	No load	η typ.	Ripple	Pinning
Single Output	VDC	VDC	mA	mA	%	mVpp	
SC05-3V302NS	4.5...9.0	3.3	500	60	73	75	S7-1
SC05-0502NS	4.5...9.0	5.0	400	60	76	75	S7-1
SC05-1202NS	4.5...9.0	12.0	167	60	80	75	S7-1
SC05-1502NS	4.5...9.0	15.0	134	60	80	75	S7-1
SC12-3V302NS	9.0...18.0	3.3	500	30	76	75	S7-1
SC12-0502NS	9.0...18.0	5.0	400	30	79	75	S7-1
SC12-1202NS	9.0...18.0	12.0	167	30	82	75	S7-1
SC12-1502NS	9.0...18.0	15.0	134	30	83	75	S7-1
SC24-3V302NS	18.0...36.0	3.3	500	18	76	75	S7-1
SC24-0502NS	18.0...36.0	5.0	400	18	79	75	S7-1
SC24-1202NS	18.0...36.0	12.0	167	18	82	75	S7-1
SC24-1502NS	18.0...36.0	15.0	134	18	83	75	S7-1
SC48-3V302NS	36.0...75.0	3.3	500	9	74	75	S7-1
SC48-0502NS	36.0...75.0	5.0	400	9	79	75	S7-1
SC48-1202NS	36.0...75.0	12.0	167	9	82	75	S7-1
SC48-1502NS	36.0...75.0	15.0	134	9	84	75	S7-1
Dual Output	VDC	VDC	mA	mA	%	mVpp	
SC05-0502ND	4.5...9.0	±5.0	±200	60	77	75	S7-5
SC05-1202ND	4.5...9.0	±12.0	±83	60	79	75	S7-5
SC05-1502ND	4.5...9.0	±15.0	±67	60	80	75	S7-5
SC12-0502ND	9.0...18.0	±5.0	±200	30	79	75	S7-5
SC12-1202ND	9.0...18.0	±12.0	±83	30	82	75	S7-5
SC12-1502ND	9.0...18.0	±15.0	±67	30	83	75	S7-5
SC24-0502ND	18.0...36.0	±5.0	±200	18	79	75	S7-5
SC24-1202ND	18.0...36.0	±12.0	±83	18	81	75	S7-5
SC24-1502ND	18.0...36.0	±15.0	±67	18	84	75	S7-5
SC48-0502ND	36.0...75.0	±5.0	±200	9	78	75	S7-5
SC48-1202ND	36.0...75.0	±12.0	±83	9	82	75	S7-5
SC48-1502ND	36.0...75.0	±15.0	±67	9	84	75	S7-5

1.5 Watt

EC-Series, DIL-24



DC/DC converter with single or dual outputs

- I/O isolation of 500 (Suffix M), 1'500 (Suffix H) or 3'000 VDC (Suffix V)
- Pi-filter at input
- Continuous short circuit proof
- Linear regulation
- No derating up to 71 °C
- Low output ripple and noise
- Metal case with non conductive base plate, six sides shielded or non conductive plastic case
- SMD version for I/O isolation of 500 available (Suffix M-S)
- **Dimensions (L x W x H): 32 x 20 x 10.2 mm**

Model	Uin	Uout	Iout	No load	η typ.	Ripple	Pinning
Single Output	VDC	VDC	mA	mA	%	mVpp	
EC05-0502SM	4.5...5.5	5.0	300	110	50	50	A1
EC05-1202SM	4.5...5.5	12.0	125	110	50	50	A1
EC05-1502SM	4.5...5.5	15.0	100	110	50	50	A1
EC12-0502SM	10.8...13.2	5.0	300	40	50	50	A1
EC12-1202SM	10.8...13.2	12.0	125	40	50	50	A1
EC12-1502SM	10.8...13.2	15.0	100	40	50	50	A1
EC24-0502SM	21.6...26.4	5.0	300	20	50	50	A1
EC24-1202SM	21.6...26.4	12.0	125	20	50	50	A1
EC24-1502SM	21.6...26.4	15.0	100	20	50	50	A1
EC48-0502SM	43.2...52.8	5.0	300	15	50	50	A1
EC48-1202SM	43.2...52.8	12.0	125	15	50	50	A1
EC48-1502SM	43.2...52.8	15.0	100	15	50	50	A1
Dual Output	VDC	VDC	mA	mA	%	mVpp	
EC05-1202DM	4.5...5.5	±12.0	±60	110	50	50	A2
EC05-1502DM	4.5...5.5	±15.0	±50	110	50	50	A2
EC12-1202DM	10.8...13.2	±12.0	±60	40	50	50	A2
EC12-1502DM	10.8...13.2	±15.0	±50	40	50	50	A2
EC24-1202DM	21.6...26.4	±12.0	±60	20	50	50	A2
EC24-1502DM	21.6...26.4	±15.0	±50	20	50	50	A2
EC48-1202DM	43.2...52.8	±12.0	±60	15	50	50	A2
EC48-1502DM	43.2...52.8	±15.0	±50	15	50	50	A2
Standard Version:	EC...02xM	M = 500 VDC I/O Isolation and metal case				Pinning A1 (s)/ A2 (d)	
Option:	EC...02xV	V = 3'000 I/O Isolation and plastic case				Pinning A6 (s)/ A7 (d)	

1.5 Watt

EC-Series, SMD



DC/DC converter with single or dual outputs

- I/O isolation of 500 (Suffix M), 1'500 (Suffix H) or 3'000 VDC (Suffix V)
- Pi-filter at input
- Continuous short circuit proof
- Linear regulation
- No derating up to 71 °C
- Low output ripple and noise
- Metal case with non conductive base plate, six sides shielded or non conductive plastic case
- **Dimensions (L x W x H): 32 x 20 x 11.4 mm**

Model	Uin	Uout	Iout	No load	η typ.	Ripple	Pinning
Single Output	VDC	VDC	mA	mA	%	mVpp	
EC05-0502SM-S	4.5...5.5	5.0	300	110	50	50	AS1
EC05-1202SM-S	4.5...5.5	12.0	125	110	50	50	AS1
EC05-1502SM-S	4.5...5.5	15.0	100	110	50	50	AS1
EC12-0502SM-S	10.8...13.2	5.0	300	40	50	50	AS1
EC12-1202SM-S	10.8...13.2	12.0	125	40	50	50	AS1
EC12-1502SM-S	10.8...13.2	15.0	100	40	50	50	AS1
EC24-0502SM-S	21.6...26.4	5.0	300	20	50	50	AS1
EC24-1202SM-S	21.6...26.4	12.0	125	20	50	50	AS1
EC24-1502SM-S	21.6...26.4	15.0	100	20	50	50	AS1
EC48-0502SM-S	43.2...52.8	5.0	300	15	50	50	AS1
EC48-1202SM-S	43.2...52.8	12.0	125	15	50	50	AS1
EC48-1502SM-S	43.2...52.8	15.0	100	15	50	50	AS1
Dual Output	VDC	VDC	mA	mA	%	mVpp	
EC05-1202DM-S	4.5...5.5	±12.0	±60	110	50	50	AS2
EC05-1502DM-S	4.5...5.5	±15.0	±50	110	50	50	AS2
EC12-1202DM-S	10.8...13.2	±12.0	±60	40	50	50	AS2
EC12-1502DM-S	10.8...13.2	±15.0	±50	40	50	50	AS2
EC24-1202DM-S	21.6...26.4	±12.0	±60	20	50	50	AS2
EC24-1502DM-S	21.6...26.4	±15.0	±50	20	50	50	AS2
EC48-1202DM-S	43.2...52.8	±12.0	±60	15	50	50	AS2
EC48-1502DM-S	43.2...52.8	±15.0	±50	15	50	50	AS2
Standard Version:	EC...02xM	M = 500 VDC I/O Isolation and metal case				Pinning A1 (s)/ A2 (d)	
Option:	EC...02xV	V = 3'000 I/O Isolation and plastic case				Pinning A6 (s)/ A7 (d)	

2 Watt

SCW-Series, SIL-8



Single inline regulated DC/DC module

- I/O isolation of 1'500 VDC
- Efficiency up to 83 %
- No derating up to 85 °C ambient temperature
- Continuous short circuit protection
- **Dimensions (L x W x H): 21.8 x 9.2 x 11.1 mm**

Model	U _{in}	U _{out}	I _{out}	No load	η typ.	Ripple	Pinning
Single Output	VDC	VDC	mA	mA	%	mVpp	
SCW05-3V302SH	4.5...9	3.3	500	60.0	72	75	S8-1
SCW05-0502SH	4.5...9	5.0	400	60.0	76	75	S8-1
SCW05-1202SH	4.5...9	12.0	167	60.0	79	75	S8-1
SCW05-1502SH	4.5...9	15.0	134	60.0	80	75	S8-1
SCW12-3V302SH	9...18	3.3	500	30.0	74	75	S8-1
SCW12-0502SH	9...18	5.0	400	30.0	78	75	S8-1
SCW12-1202SH	9...18	12.0	167	30.0	81	75	S8-1
SCW12-1502SH	9...18	15.0	134	30.0	82	75	S8-1
SCW24-3V302SH	18...36	3.3	500	18.0	76	75	S8-1
SCW24-0502SH	18...36	5.0	400	18.0	78	75	S8-1
SCW24-1202SH	18...36	12.0	167	18.0	81	75	S8-1
SCW24-1502SH	18...36	15.0	134	18.0	82	75	S8-1
SCW48-3V302SH	36...75	3.3	500	9.0	74	75	S8-1
SCW48-0502SH	36...75	5.0	400	9.0	78	75	S8-1
SCW48-1202SH	36...75	12.0	167	9.0	82	75	S8-1
SCW48-1502SH	36...75	15.0	134	9.0	83	75	S8-1
Dual Output	VDC	VDC	mA	mA	%	mVpp	
SCW05-0502DH	4.5...9	±5.0	±200	60.0	76	75	S8-2
SCW05-1202DH	4.5...9	±12.0	±83	60.0	80	75	S8-2
SCW05-1502DH	4.5...9	±15.0	±67	60.0	80	75	S8-2
SCW12-0502DH	9...18	±5.0	±200	30.0	80	75	S8-2
SCW12-1202DH	9...18	±12.0	±83	30.0	82	75	S8-2
SCW12-1502DH	9...18	±15.0	±67	30.0	82	75	S8-2
SCW24-0502DH	18...36	±5.0	±200	18.0	78	75	S8-2
SCW24-1202DH	18...36	±12.0	±83	18.0	81	75	S8-2
SCW24-1502DH	18...36	±15.0	±67	18.0	82	75	S8-2
SCW48-0502DH	36...75	±5.0	±200	9.0	78	75	S8-2
SCW48-1202DH	36...75	±12.0	±83	9.0	83	75	S8-2
SCW48-1502DH	36...75	±15.0	±67	9.0	82	75	S8-2

3 Watt

ECU-Series, DIL-24



4:1 input voltage range DC/DC converter line with single or dual outputs

- I/O isolation of 500 (Suffix M), 1'500 (Suffix H) or 3'000 VDC (Suffix V)
- Continuous short circuit proof
- High efficiency
- No derating up to 71 °C
- Pi-filter at input
- Metal case with non conductive base plate, six sides shielded or non conductive plastic case
- **Dimensions (L x W x H): 32 x 20 x 10.2 mm**

Model	U _{in}	U _{out}	I _{out}	No load	η typ.	Ripple	Pinning
Single Output	VDC	VDC	mA	mA	%	mVpp	
ECU24-0303SM	9...36	3.3	600	15.0	70	100	A1
ECU24-0503SM	9...36	5.0	600	15.0	72	100	A1
ECU24-1203SM	9...36	12.0	250	15.0	76	100	A1
ECU24-1503SM	9...36	15.0	200	15.0	76	100	A1
ECU48-0303SM	18...72	3.3	600	7.5	70	100	A1
ECU48-0503SM	18...72	5.0	600	7.5	72	100	A1
ECU48-1203SM	18...72	12.0	250	7.5	80	100	A1
ECU48-1503SM	18...72	15.0	200	7.5	80	100	A1
Dual Output	VDC	VDC	mA	mA	%	mVpp	
ECU24-0503DM	9...36	±5.0	±300	25.0	70	100	A2
ECU24-1203DM	9...36	±12.0	±125	25.0	72	120	A2
ECU24-1503DM	9...36	±15.0	±100	25.0	72	150	A2
ECU48-0503DM	18...72	±5.0	±300	12.0	71	100	A2
ECU48-1203DM	18...72	±12.0	±125	12.0	72	120	A2
ECU48-1503DM	18...72	±15.0	±100	12.0	72	150	A2
Standard Version:	ECU...-.03xM	M = 500 VDC I/O isolation and metal case				Pinning A1 (s)/A2 (d)	
Option:	ECU...-.03xH	H = 1'500 VDC I/O isolation and metal case				Pinning A4 (s)/A5 (d)	
	ECU...-.03xV	V = 3'000 VDC I/O isolation and plastic case				Pinning A4 (s)/A5 (d)	

3 Watt**ECU-Series, SMD****4:1 input voltage range DC/DC converter line with single or dual outputs**

- I/O isolation of 500 (Suffix M), 1'500 (Suffix H) or 3'000 VDC (Suffix V)
- Continuous short circuit proof
- High efficiency
- No derating up to 71 °C
- Pi-filter at input
- Metal case with non conductive base plate, six sides shielded or non conductive plastic case
- **Dimensions (L x W x H): 32 x 20 x 11.4 mm**

Model	U _{in}	U _{out}	I _{out}	No load	η typ.	Ripple	Pinning
Single Output							
	VDC	VDC	mA	mA	%	mV _{pp}	
ECU24-0303SM-S	9...36	3.3	600	15.0	70	100	AS1
ECU24-0503SM-S	9...36	5.0	600	15.0	72	100	AS1
ECU24-1203SM-S	9...36	12.0	250	15.0	76	100	AS1
ECU24-1503SM-S	9...36	15.0	200	15.0	76	100	AS1
ECU48-0303SM-S	18...72	3.3	600	7.5	70	100	AS1
ECU48-0503SM-S	18...72	5.0	600	7.5	72	100	AS1
ECU48-1203SM-S	18...72	12.0	250	7.5	80	100	AS1
ECU48-1503SM-S	18...72	15.0	200	7.5	80	100	AS1
Dual Output							
	VDC	VDC	mA	mA	%	mV _{pp}	
ECU24-0503DM-S	9...36	±5.0	±300	25.0	70	100	AS2
ECU24-1203DM-S	9...36	±12.0	±125	25.0	72	120	AS2
ECU24-1503DM-S	9...36	±15.0	±100	25.0	72	150	AS2
ECU48-0503DM-S	18...72	±5.0	±300	12.0	71	100	AS2
ECU48-1203DM-S	18...72	±12.0	±125	12.0	72	120	AS2
ECU48-1503DM-S	18...72	±15.0	±100	12.0	72	150	AS2
Standard Version:	ECU...-...03xM	M = 500 VDC I/O isolation and metal case				Pinning A1 (s)/ A2 (d)	
Option:	ECU...-...03xH	H = 1'500 VDC I/O isolation and metal case				Pinning A4 (s)/ A5 (d)	
	ECU...-...03xV	V = 3'000 VDC I/O isolation and plastic case				Pinning A4 (s)/ A5 (d)	

3 Watt**ECW-Series, DIL-24****2:1 input voltage range DC/DC converter line with single or dual outputs**

- I/O isolation of 500 (Suffix M), 1'500 (Suffix H) or 3'000 VDC (Suffix V)
 - Continuous short circuit proof
 - Remote on/off control optional
 - No derating up to 71 °C
 - Pi-filter at input
 - Metal case with non conductive base plate, six sides shielded or non conductive plastic case
 - EMC according to EN55022 Class B optional
- Dimensions (L x W x H):**
Class A: 32 x 20 x 10.2 mm
Class B: 32 x 20 x 12.7 mm

Model	U _{in}	U _{out}	I _{out}	No load	η typ.	Ripple	Pinning
Single Output	VDC	VDC	mA	mA	%	mVpp	
ECW05-0303SM	4.5...6.0	3.3	600	15.0	61	100	A1
ECW05-0503SM	4.5...6.0	5.0	600	15.0	70	100	A1
ECW05-1203SM	4.5...6.0	12.0	250	15.0	75	120	A1
ECW05-1503SM	4.5...6.0	15.0	200	15.0	75	150	A1
ECW12-0303SM	9...18	3.3	600	7.5	65	100	A1
ECW12-0503SM	9...18	5.0	600	7.5	73	100	A1
ECW12-1203SM	9...18	12.0	250	7.5	78	120	A1
ECW12-1503SM	9...18	15.0	200	7.5	78	150	A1
ECW24-0303SM	18...36	3.3	600	5.0	66	100	A1
ECW24-0503SM	18...36	5.0	600	5.0	74	100	A1
ECW24-1203SM	18...36	12.0	250	5.0	80	120	A1
ECW24-1503SM	18...36	15.0	200	5.0	80	150	A1
ECW48-0303SM	36...72	3.3	600	2.0	68	100	A1
ECW48-0503SM	36...72	5.0	600	2.0	76	100	A1
ECW48-1203SM	36...72	12.0	250	2.0	80	120	A1
ECW48-1503SM	36...72	15.0	200	2.0	80	150	A1
Dual Output	VDC	VDC	mA	mA	%	mVpp	
ECW05-0503DM	4.5...6.0	±5.0	±300	25.0	70	100	A2
ECW05-1203DM	4.5...6.0	±12.0	±125	25.0	75	120	A2
ECW05-1503DM	4.5...6.0	±15.0	±100	25.0	75	150	A2
ECW12-0503DM	9...18	±5.0	±300	12.0	73	100	A2
ECW12-1203DM	9...18	±12.0	±125	12.0	78	120	A2
ECW12-1503DM	9...18	±15.0	±100	12.0	78	150	A2
ECW24-0503DM	18...36	±5.0	±300	7.5	74	100	A2
ECW24-1203DM	18...36	±12.0	±125	7.5	80	120	A2
ECW24-1503DM	18...36	±15.0	±100	7.5	80	150	A2
ECW48-0503DM	36...72	±5.0	±300	3.0	76	100	A2
ECW48-1203DM	36...72	±12.0	±125	3.0	78	120	A2
ECW48-1503DM	36...72	±15.0	±100	3.0	78	150	A2
Standard Version:	ECW...-...03xM	M = 500 VDC I/O isolation and metal case				Pinning A1 (s)/ A2 (d)	
Option:	ECW...-...03xH	H = 1'500 VDC I/O isolation and metal case				Pinning A4 (s)/ A5 (d)	
	ECW...-...03xV	V = 3'000 VDC I/O isolation and plastic case				Pinning A4 (s)/ A5 (d)	
	ECW...-...03xxB	B = EN55022 Class B					
	ECW...-...03xxBT	BT = EN55022 Class B & remote on/off ctrl for 1'500 and 3'000 VDC only				see data sheet	

3 Watt

ECW-Series, SMD



2:1 input voltage range DC/DC converter line with single or dual outputs

- I/O isolation of 500 (Suffix M), 1'500 (Suffix H) or 3'000 VDC (Suffix V)
- Continuous short circuit proof
- Remote on/off control optional
- No derating up to 71 °C
- Pi-filter at input
- Metal case with non conductive base plate, six sides shielded or non conductive plastic case
- EMC according to EN55022 Class B optional
- **Dimensions (L x W x H): 32 x 20 x 11.4 mm**

Model	U _{in}	U _{out}	I _{out}	No load	η typ.	Ripple	Pinning
Single Output							
	VDC	VDC	mA	mA	%	mVpp	
ECW05-0303SM-S	4.5...6.0	3.3	600	15.0	61	100	AS1
ECW05-0503SM-S	4.5...6.0	5.0	600	15.0	70	100	AS1
ECW05-1203SM-S	4.5...6.0	12.0	250	15.0	75	120	AS1
ECW05-1503SM-S	4.5...6.0	15.0	200	15.0	75	150	AS1
ECW12-0303SM-S	9...18	3.3	600	7.5	65	100	AS1
ECW12-0503SM-S	9...18	5.0	600	7.5	73	100	AS1
ECW12-1203SM-S	9...18	12.0	250	7.5	78	120	AS1
ECW12-1503SM-S	9...18	15.0	200	7.5	78	150	AS1
ECW24-0303SM-S	18...36	3.3	600	5.0	66	100	AS1
ECW24-0503SM-S	18...36	5.0	600	5.0	74	100	AS1
ECW24-1203SM-S	18...36	12.0	250	5.0	80	120	AS1
ECW24-1503SM-S	18...36	15.0	200	5.0	80	150	AS1
ECW48-0303SM-S	36...72	3.3	600	2.0	68	100	AS1
ECW48-0503SM-S	36...72	5.0	600	2.0	76	100	AS1
ECW48-1203SM-S	36...72	12.0	250	2.0	80	120	AS1
ECW48-1503SM-S	36...72	15.0	200	2.0	80	150	AS1
Dual Output							
	VDC	VDC	mA	mA	%	mVpp	
ECW05-0503DM-S	4.5...6.0	±5.0	±300	25.0	70	100	AS2
ECW05-1203DM-S	4.5...6.0	±12.0	±125	25.0	75	120	AS2
ECW05-1503DM-S	4.5...6.0	±15.0	±100	25.0	75	150	AS2
ECW12-0503DM-S	9...18	±5.0	±300	12.0	73	100	AS2
ECW12-1203DM-S	9...18	±12.0	±125	12.0	78	120	AS2
ECW12-1503DM-S	9...18	±15.0	±100	12.0	78	150	AS2
ECW24-0503DM-S	18...36	±5.0	±300	7.5	74	100	AS2
ECW24-1203DM-S	18...36	±12.0	±125	7.5	80	120	AS2
ECW24-1503DM-S	18...36	±15.0	±100	7.5	80	150	AS2
ECW48-0503DM-S	36...72	±5.0	±300	3.0	76	100	AS2
ECW48-1203DM-S	36...72	±12.0	±125	3.0	78	120	AS2
ECW48-1503DM-S	36...72	±15.0	±100	3.0	78	150	AS2
Standard Version:	ECW...-...03xM	M = 500 VDC I/O isolation and metal case				Pinning A1 (s)/ A2 (d)	
Option:	ECW...-...03xH	H = 1'500 VDC I/O isolation and metal case				Pinning A4 (s)/ A5 (d)	
	ECW...-...03xV	V = 3'000 VDC I/O isolation and plastic case				Pinning A4 (s)/ A5 (d)	
	ECW...-...03xB	B = EN55022 Class B					
	ECW...-...03xBT	BT = EN55022 Class B & remote on/off ctrl for 1'500 and 3'000 VDC only				see data sheet	

3 Watt

SCU-Series

4:1 input voltage range DC/DC converter with single or dual outputs

- I/O isolation of 1'500 VDC
- Efficiency up to 85 %
- No derating up to 75 °C ambient temperature
- Remote on/off control
- Continuous short circuit protection
- Input Under Voltage Protection
- **Dimensions (L x W x H): 21.8 x 9.2 x 11.1 mm**

Model	U _{in}	U _{out}	I _{out}	No load	η typ.	Ripple	Pinning
Single Output	VDC	VDC	mA	mA	%	mVpp	
SCU24-0503SH	9...36	5.0	600	4	81	50	S8-2
SCU24-1203SH	9...36	12.0	250	4	84	50	S8-2
SCU24-1503SH	9...36	15.0	200	4	84	50	S8-2
SCU24-3V303SH	9...36	3.3	700	4	79	50	S8-2
SCU48-0503SH	18...72	5.0	600	3	82	50	S8-2
SCU48-1203SH	18...72	12.0	250	5	85	50	S8-2
SCU48-1503SH	18...72	15.0	200	5	84	50	S8-2
SCU48-3V303SH	18...72	3.3	700	3	79	50	S8-2
Dual Output	VDC	VDC	mA	mA	%	mVpp	
SCW05-0503DH	4.5...9	±5.0	±300	60	78	75	S8-2
SCW05-1203DH	4.5...9	±12.0	±125	60	81	75	S8-2
SCW05-1503DH	4.5...9	±15.0	±100	60	81	75	S8-2
SCW12-0502DH	9...18	±5.0	±300	30	82	75	S8-2
SCW12-1203DH	9...18	±12.0	±125	30	83	75	S8-2
SCW12-1503DH	9...18	±15.0	±100	30	84	75	S8-2
Standard Version:	ECU...03xM	M = 500 VDC I/O isolation and metal case				Pinning A1 (s)/A2 (d)	
Option:	ECU...03xH	H = 1'500 VDC I/O isolation and metal case				Pinning A4 (s)/A5 (d)	
	ECU...03xV	V = 3'000 VDC I/O isolation and plastic case				Pinning A4 (s)/A5 (d)	

3 Watt

SCW-Series, SIL-8

Single inline regulated DC/DC module

- I/O isolation of 1'500 VDC
- Efficiency up to 86 %
- No derating up to 71 °C ambient temperature
- Continuous short circuit protection
- **Dimensions (L x W x H): 21.8 x 9.2 x 11.1 mm**

Model	U _{in}	U _{out}	I _{out}	No load	η typ.	Ripple	Pinning
Single Output	VDC	VDC	mA	mA	%	mVpp	
SCW05-3V303SH	4.5...9	3.3	700	60	73	75	S8-1
SCW05-0503SH	4.5...9	5.0	600	60	78	75	S8-1
SCW05-1203SH	4.5...9	12.0	250	60	81	75	S8-1
SCW05-1503SH	4.5...9	15.0	200	60	81	75	S8-1
SCW12-3V303SH	9...18	3.3	700	30	76	75	S8-1
SCW12-0503SH	9...18	5.0	600	30	81	75	S8-1
SCW12-1203SH	9...18	12.0	250	30	83	75	S8-1
SCW12-1503SH	9...18	15.0	200	30	84	75	S8-1
SCW24-3V303SH	18...36	3.3	700	18	77	75	S8-1
SCW24-0503SH	18...36	5.0	600	18	81	75	S8-1
SCW24-1203SH	18...36	12.0	250	18	84	75	S8-1
SCW24-1503SH	18...36	15.0	200	18	85	75	S8-1
SCW48-3V303SH	36...75	3.3	700	9	77	75	S8-1
SCW48-0503SH	36...75	5.0	600	9	81	75	S8-1
SCW48-1203SH	36...75	12.0	250	9	86	75	S8-1
SCW48-1503SH	36...75	15.0	200	9	86	75	S8-1
Dual Output	VDC	VDC	mA	mA	%	mVpp	
SCW05-0503DH	4.5...9	±5.0	±300	60	78	75	S8-2
SCW05-1203DH	4.5...9	±12.0	±125	60	81	75	S8-2
SCW05-1503DH	4.5...9	±15.0	±100	60	81	75	S8-2
SCW12-0502DH	9...18	±5.0	±300	30	82	75	S8-2
SCW12-1203DH	9...18	±12.0	±125	30	83	75	S8-2
SCW12-1503DH	9...18	±15.0	±100	30	84	75	S8-2
SCW24-0503DH	18...36	±5.0	±300	18	80	75	S8-2
SCW24-1203DH	18...36	±12.0	+125	18	84	75	S8-2
SCW24-1503DH	18...36	±15.0	+100	18	85	75	S8-2
SCW48-0503DH	36...75	±5.0	±300	9	81	75	S8-2
SCW48-1203DH	36...75	±12.0	±125	9	86	75	S8-2
SCW48-1503DH	36...75	±15.0	±100	9	86	75	S8-2

3 Watt**UCW-Series, DIL-24****2:1 input voltage range DC/DC converter line with single or dual output**

- I/O isolation of 1'500 (Suffix H) or 3'000 VDC (Suffix V)
- Continuous short circuit proof
- No derating up to 71 °C
- Pi-filter at input
- Metal case with non conductive base plate, six sides shielded or non conductive plastic case
- EMC according to EN55022 Class B optional (Suffix -B)
- UL and cUL 1950 certified
- **Dimensions (L x W x H):**
Class A: 32 x 20 x 10.2 mm
Class B: 32 x 20 x 12.7 mm



Model	Uin	Uout	Iout	No load	η typ.	Ripple	Pinning
Single Output	VDC	VDC	mA	mA	%	mVpp	
UCW05-0303SH	4.5...6.0	3.3	600	15.0	61	100	A4
UCW05-0503SH	4.5...6.0	5.0	600	15.0	70	100	A4
UCW05-1203SH	4.5...6.0	12.0	250	15.0	75	120	A4
UCW05-1503SH	4.5...6.0	15.0	200	15.0	75	150	A4
UCW12-0303SH	9...18	3.3	600	7.5	65	100	A4
UCW12-0503SH	9...18	5.0	600	7.5	73	100	A4
UCW12-1203SH	9...18	12.0	250	7.5	78	120	A4
UCW12-1503SH	9...18	15.0	200	7.5	78	150	A4
UCW24-0303SH	18...36	3.3	600	5.0	66	100	A4
UCW24-0503SH	18...36	5.0	600	5.0	74	100	A4
UCW24-1203SH	18...36	12.0	250	5.0	80	120	A4
UCW24-1503SH	18...36	15.0	200	5.0	80	150	A4
UCW48-0303SH	36...72	3.3	600	2.0	68	100	A4
UCW48-0503SH	36...72	5.0	600	2.0	76	100	A4
UCW48-1203SH	36...72	12.0	250	2.0	80	120	A4
UCW48-1503SH	36...72	15.0	200	2.0	80	150	A4
Dual Output	VDC	VDC	mA	mA	%	mVpp	
UCW05-0503DH	4.5...6.0	±5.0	±300	25.0	70	100	A5
UCW05-1203DH	4.5...6.0	±12.0	±125	25.0	75	120	A5
UCW05-1503DH	4.5...6.0	±15.0	±100	25.0	75	150	A5
UCW12-0503DH	9...18	±5.0	±300	12.0	73	100	A5
UCW12-1203DH	9...18	±12.0	±125	12.0	78	120	A5
UCW12-1503DH	9...18	±15.0	±100	12.0	78	150	A5
UCW24-0503DH	18...36	±5.0	±300	7.5	74	100	A5
UCW24-1203DH	18...36	±12.0	±125	7.5	80	120	A5
UCW24-1503DH	18...36	±15.0	±100	7.5	80	150	A5
UCW48-0503DH	36...72	±5.0	±300	3.0	76	100	A5
UCW48-1203DH	36...72	±12.0	±125	3.0	78	120	A5
UCW48-1503DH	36...72	±15.0	±100	3.0	78	150	A5
Standard Version:	UCW...03xH	H = 1'500 VDC I/O isolation and metal case				Pinning A4 (s)/ A5 (d)	
Option:	UCW...03xV	V = 3'000 VDC I/O isolation and plastic case				Pinning A4 (s)/ A5 (d)	
	UCW...03xB	B = EMC EN55022 Class B					

5-6 Watt**ECU-Series, DIL-24****4:1 input voltage range DC/DC converter line with single or dual outputs**

- I/O isolation of 1'500 (Suffix H) or 3'000 VDC (Suffix V)
- Continuous short circuit proof
- High efficiency
- No derating up to 71 °C
- Pi-filter at input
- Metal case with non conductive base plate, six sides shielded or non conductive plastic case
- **Dimensions (L x W x H): 32 x 20 x 10.2 mm**

Model	Uin	Uout	Iout	No load	η typ.	Ripple	Pinning
Single Output	VDC	VDC	mA	mA	%	mVpp	
ECU24-0305SH	9...36	3.3	1000	15.0	72	100	A4
ECU24-0505SH	9...36	5.0	1000	15.0	78	100	A4
ECU24-1206SH	9...36	12.0	470	15.0	80	120	A4
ECU24-1506SH	9...36	15.0	400	15.0	80	150	A4
ECU48-0305SH	18...72	3.3	1000	7.5	70	100	A4
ECU48-0505SH	18...72	5.0	1000	7.5	78	100	A4
ECU48-1206SH	18...72	12.0	470	7.5	79	120	A4
ECU48-1506SH	18...72	15.0	400	7.5	80	150	A4
Dual Output	VDC	VDC	mA	mA	%	mVpp	
ECU24-0505DH	9...36	±5.0	±500	25.0	78	75	A5
ECU24-1206DH	9...36	±12.0	±230	25.0	80	120	A5
ECU24-1506DH	9...36	±15.0	±190	25.0	80	150	A5
ECU48-0505DH	18...72	±5.0	±500	12.0	77	75	A5
ECU48-1206DH	18...72	±12.0	±230	12.0	79	120	A5
ECU48-1506DH	18...72	±15.0	±190	12.0	80	150	A5
Standard Version:	ECU...06xH	H = 1'500 VDC I/O isolation and metal case				Pinning A4 (s)/ A5 (d)	
Option:	ECU...06xV	V = 3'000 VDC I/O isolation and plastic case				Pinning A4 (s)/ A5 (d)	

5-6 Watt

ECU-Series, SMD



4:1 input voltage range DC/DC converter line with single or dual outputs

- I/O isolation of 1'500 (Suffix H) or 3'000 VDC (Suffix V)
- Continuous short circuit proof
- High efficiency
- No derating up to 71 °C
- Pi-filter at input
- Metal case with non conductive base plate, six sides shielded or non conductive plastic case
- **Dimensions (L x W x H): 32 x 20 x 11.4 mm**

Model	U _{in}	U _{out}	I _{out}	No load	η typ.	Ripple	Pinning
Single Output	VDC	VDC	mA	mA	%	mVpp	
ECU24-0305SH-S	9...36	3.3	1000	15.0	72	100	AS4
ECU24-0505SH-S	9...36	5.0	1000	15.0	78	100	AS4
ECU24-1206SH-S	9...36	12.0	470	15.0	80	120	AS4
ECU24-1506SH-S	9...36	15.0	400	15.0	80	150	AS4
ECU48-0305SH-S	18...72	3.3	1000	7.5	70	100	AS4
ECU48-0505SH-S	18...72	5.0	1000	7.5	78	100	AS4
ECU48-1206SH-S	18...72	12.0	470	7.5	79	120	AS4
ECU48-1506SH-S	18...72	15.0	400	7.5	80	150	AS4
Dual Output	VDC	VDC	mA	mA	%	mVpp	
ECU24-0505DH-S	9...36	±5.0	±500	25.0	78	75	AS5
ECU24-1206DH-S	9...36	±12.0	±230	25.0	80	120	AS5
ECU24-1506DH-S	9...36	±15.0	±190	25.0	80	150	AS5
ECU48-0505DH-S	18...72	±5.0	±500	12.0	77	75	AS5
ECU48-1206DH-S	18...72	±12.0	±230	12.0	79	120	AS5
ECU48-1506DH-S	18...72	±15.0	±190	12.0	80	150	AS5
Standard Version:	ECU...06xH	H = 1'500 VDC I/O isolation and metal case				Pinning A4 (s)/ A5 (d)	
Option:	ECU...06xV	V = 3'000 VDC I/O isolation and plastic case				Pinning A4 (s)/ A5 (d)	

5-6 Watt

ECW-Series, DIL-24



2:1 input voltage range DC/DC converter line with single or dual outputs

- I/O isolation of 500 (Suffix M) 1'500 (Suffix H) or 3'000 VDC (Suffix V)
- Continuous short circuit proof
- High efficiency
- No derating up to 71 °C
- Pi-filter at input
- Remote on/off control optional (Suffix T)
- Low output ripple and noise
- Metal case with non conductive base plate, six sides shielded or non conductive plastic case
- EN55022 Class B optional (Suffix B)
- **Dimensions (L x W x H):**
Class A: 32 x 20 x 10.2 mm
Class B: 32 x 20 x 12.7 mm

Model	U _{in}	U _{out}	I _{out}	No load	η typ.	Ripple	Pinning
Single Output	VDC	VDC	mA	mA	%	mVpp	
ECW12-0305SM	9...18	3.3	1000	7.5	68	100	A1
ECW12-0505SM	9...18	5.0	1000	7.5	76	100	A1
ECW12-1206SM	9...18	12.0	470	7.5	80	120	A1
ECW12-1506SM	9...18	15.0	400	7.5	80	150	A1
ECW24-0305SM	18...36	3.3	1000	5.0	70	100	A1
ECW24-0505SM	18...36	5.0	1000	5.0	78	100	A1
ECW24-1206SM	18...36	12.0	470	5.0	82	120	A1
ECW24-1506SM	18...36	15.0	400	5.0	82	150	A1
ECW48-0305SM	36...72	3.3	1000	2.0	70	100	A1
ECW48-0505SM	36...72	5.0	1000	2.0	78	100	A1
ECW48-1206SM	36...72	12.0	470	2.0	81	120	A1
ECW48-1506SM	36...72	15.0	400	2.0	81	150	A1
Dual Output	VDC	VDC	mA	mA	%	mVpp	
ECW12-0505DM	9...18	±5.0	±500	12.0	76	100	A2
ECW12-1206DM	9...18	±12.0	±230	12.0	80	120	A2
ECW12-1506DM	9...18	±15.0	±190	12.0	80	150	A2
ECW24-0505DM	18...36	±5.0	±500	7.5	78	100	A2
ECW24-1206DM	18...36	±12.0	±230	7.5	81	120	A2
ECW24-1506DM	18...36	±15.0	±190	7.5	81	150	A2
ECW48-0505DM	36...72	±5.0	±500	3.0	78	100	A2
ECW48-1206DM	36...72	±12.0	±230	3.0	81	120	A2
ECW48-1506DM	36...72	±15.0	±190	3.0	81	150	A2
Standard Version:	ECW...06xM	M = 500 VDC I/O isolation and metal case				Pinning A1 (s)/ A2 (d)	
Option:	ECW...06xH	H = 1'500 VDC I/O isolation and metal case				Pinning A4 (s)/ A5 (d)	
	ECW...06xV	V = 3'000 VDC I/O isolation and plastic case				Pinning A4 (s)/ A5 (d)	
	ECW...06xB	B = EMC EN55022 Class B					
	ECW...06xBT	B = EMC EN55022 Class B & remote on/off ctrl, for 1'500 and 3'000 VDC only				Pinning see data sheet	

5-6 Watt

ECW-Series, SMD

2:1 input voltage range DC/DC converter line with single or dual outputs

- I/O isolation of 500 (Suffix M) 1'500 (Suffix H) or 3'000 VDC (Suffix V)
- Continuous short circuit proof
- High efficiency
- No derating up to 71 °C
- Pi-filter at input
- Remote on/off control optional (Suffix T)
- Low output ripple and noise
- **Dimensions (L x W x H): 32 x 20 x 11.4 mm**

Model	U _{in}	U _{out}	I _{out}	No load	η typ.	Ripple	Pinning
Single Output							
	VDC	VDC	mA	mA	%	mVpp	
ECW12-0305SM-S	9...18	3.3	1000	7.5	68	100	AS1
ECW12-0305SM-S	9...18	5.0	1000	7.5	76	100	AS1
ECW12-1206SM-S	9...18	12.0	470	7.5	80	120	AS1
ECW12-1506SM-S	9...18	15.0	400	7.5	80	150	AS1
ECW24-0305SM-S	18...36	3.3	1000	5.0	70	100	AS1
ECW24-0505SM-S	18...36	5.0	1000	5.0	78	100	AS1
ECW24-1206SM-S	18...36	12.0	470	5.0	82	120	AS1
ECW24-1506SM-S	18...36	15.0	400	5.0	82	150	AS1
ECW48-0305SM-S	36...72	3.3	1000	2.0	70	100	AS1
ECW48-0505SM-S	36...72	5.0	1000	2.0	78	100	AS1
ECW48-1206SM-S	36...72	12.0	470	2.0	81	120	AS1
ECW48-1506SM-S	36...72	15.0	400	2.0	81	150	AS1
Dual Output							
	VDC	VDC	mA	mA	%	mVpp	
ECW12-0505DM-S	9...18	±5.0	±500	12.0	76	100	AS2
ECW12-1206DM-S	9...18	±12.0	±230	12.0	80	120	AS2
ECW12-1506DM-S	9...18	±15.0	±190	12.0	80	150	AS2
ECW24-0505DM-S	18...36	±5.0	±500	7.5	78	100	AS2
ECW24-1206DM-S	18...36	±12.0	±230	7.5	81	120	AS2
ECW24-1506DM-S	18...36	±15.0	±190	7.5	81	150	AS2
ECW48-0505DM-S	36...72	±5.0	±500	3.0	78	100	AS2
ECW48-1206DM-S	36...72	±12.0	±230	3.0	81	120	AS2
ECW48-1506DM-S	36...72	±15.0	±190	3.0	81	150	AS2
Standard Version:	ECW...06xM	M = 500 VDC I/O isolation and metal case				Pinning A1 (s)/ A2 (d)	
Option:	ECW...06xH	H = 1'500 VDC I/O isolation and metal case				Pinning A4 (s)/ A5 (d)	
	ECW...06xV	V = 3'000 VDC I/O isolation and plastic case				Pinning A4 (s)/ A5 (d)	
	ECW...06xB	B = EMC EN55022 Class B					
	ECW...06xBT	B = EMC EN55022 Class B & remote on/off ctrl, for 1'500 and 3'000 VDC only				Pinning see data sheet	

5-6 Watt**HCW-Series, DIL-24****2:1 input voltage range DC/DC converter line with single or dual outputs**

- Very high efficiency up to 87 %
- I/O isolation of 1'500 VDC
- Under voltage lockout
- Continuous short circuit proof
- Over voltage protection
- Pi-filter at input
- EMC according to EN55022 Class A
- **Dimensions (LxWxH): 32 x 20 x 10.2 mm**

Model	U _{in}	U _{out}	I _{out}	No load	η typ.	Ripple	Pinning
Single Output	VDC	VDC	mA	mA	%	mVpp	
HCW12-0305SH	9...18	3.3	1200	20	77	100	A9
HCW12-0505SH	9...18	5.0	1000	20	81	100	A9
HCW12-1206SH	9...18	12.0	500	20	84	100	A9
HCW12-1506SH	9...18	15.0	400	20	85	100	A9
HCW24-0305SH	18...36	3.3	1200	5	79	100	A9
HCW24-0505SH	18...36	5.0	1000	5	83	100	A9
HCW24-1206SH	18...36	12.0	500	5	86	100	A9
HCW24-1506SH	18...36	15.0	400	5	87	100	A9
HCW48-0305SH	36...72	3.3	1200	3	79	100	A9
HCW48-0505SH	36...72	5.0	1000	3	83	100	A9
HCW48-1206SH	36...72	12.0	500	3	86	100	A9
HCW48-1506SH	36...72	15.0	400	3	87	100	A9
Dual Output	VDC	VDC	mA	mA	%	mVpp	
HCW12-0505DH	9...18	±5.0	±500	20	81	100	A10
HCW12-1206DH	9...18	±12.0	±250	20	85	100	A10
HCW12-1506DH	9...18	±15.0	±200	20	85	100	A10
HCW24-0505DH	18...36	±5.0	±500	5	83	100	A10
HCW24-1206DH	18...36	±12.0	±250	5	86	100	A10
HCW24-1506DH	18...36	±15.0	±200	5	87	100	A10
HCW48-0505DH	36...72	±5.0	±500	3	83	100	A10
HCW48-1206DH	36...72	±12.0	±250	3	86	100	A10
HCW48-1506DH	36...72	±15.0	±200	5	87	100	A10

5-6 Watt**HCW-Series, SMD****2:1 input voltage range DC/DC converter line with single or dual output**

- Very high efficiency up to 87%
- I/O isolation of 1'500 VDC
- Under voltage lockout
- Continuous short circuit proof
- Over voltage protection
- Pi-filter at input
- EMC according to EN55022 Class A
- **Dimensions (LxWxH): 32 x 20 x 11.4 mm**

Model	U _{in}	U _{out}	I _{out}	No load	η typ.	Ripple	Pinning
Single Output	VDC	VDC	mA	mA	%	mVpp	
HCW12-0305SH-S	9...18	3.3	1200	20	77	100	AS9
HCW12-0505SH-S	9...18	5.0	1000	20	81	100	AS9
HCW12-1206SH-S	9...18	12.0	500	20	84	100	AS9
HCW12-1506SH-S	9...18	15.0	400	20	85	100	AS9
HCW24-0305SH-S	18...36	3.3	1200	5	79	100	AS9
HCW24-0505SH-S	18...36	5.0	1000	5	83	100	AS9
HCW24-1206SH-S	18...36	12.0	500	5	86	100	AS9
HCW24-1506SH-S	18...36	15.0	400	5	87	100	AS9
HCW48-0305SH-S	36...72	3.3	1200	3	79	100	AS9
HCW48-0505SH-S	36...72	5.0	1000	3	83	100	AS9
HCW48-1206SH-S	36...72	12.0	500	3	86	100	AS9
HCW48-1506SH-S	36...72	15.0	400	3	87	100	AS9
Dual Output	VDC	VDC	mA	mA	%	mVpp	
HCW12-0505DH-S	9...18	±5.0	±500	20	81	100	AS10
HCW12-1206DH-S	9...18	±12.0	±250	20	85	100	AS10
HCW12-1506DH-S	9...18	±15.0	±200	20	85	100	AS10
HCW24-0505DH-S	18...36	±5.0	±500	5	83	100	AS10
HCW24-1206DH-S	18...36	±12.0	±250	5	86	100	AS10
HCW24-1506DH-S	18...36	±15.0	±200	5	87	100	AS10
HCW48-0505DH-S	36...72	±5.0	±500	3	83	100	AS10
HCW48-1206DH-S	36...72	±12.0	±250	3	86	100	AS10
HCW48-1506DH-S	36...72	±15.0	±200	5	87	100	AS10

5-6 Watt**UCW-Series, DIL-24****2:1 input voltage range DC/DC converter line with single or dual output**

- I/O isolation of 1'500 (suffix H) or 3'000 VDC (suffix V)
- Continuous short circuit proof
- No derating up to 71 °C
- Pi filter at input
- Metal case with non conductive base plate, six sides shielded or non conductive plastic case
- EMC according to EN55022 Class B optional (suffix B)
- UL and cUL 1950 certified
- **Dimensions (L x W x H):**
Class A: 32 x 20 x 10.2 mm
Class B: 32 x 20 x 12.7 mm



Model	U _{in}	U _{out}	I _{out}	No load	η typ.	Ripple	Pinning
Single Output							
	VDC	VDC	mA	mA	%	mV _{p-p}	
UCW12-0305SH	9...18	3.3	1000	7.5	68	100	A4
UCW12-0505SH	9...18	5.0	1000	7.5	76	100	A4
UCW12-1206SH	9...18	12.0	470	7.5	80	120	A4
UCW12-1506SH	9...18	15.0	400	7.5	80	150	A4
UCW24-0305SH	18...36	3.3	1000	5.0	70	100	A4
UCW24-0505SH	18...36	5.0	1000	5.0	78	100	A4
UCW24-1206SH	18...36	12.0	470	5.0	82	120	A4
UCW24-1506SH	18...36	15.0	400	5.0	82	150	A4
UCW48-0305SH	36...72	3.3	1000	2.0	70	100	A4
UCW48-0505SH	36...72	5.0	1000	2.0	78	100	A4
UCW48-1206SH	36...72	12.0	470	2.0	81	120	A4
UCW48-1506SH	36...72	15.0	400	2.0	81	150	A4
Dual Output							
	VDC	VDC	mA	mA	%	mV _{p-p}	
UCW12-0505DH	9...18	±5.0	±500	12.0	76	100	A5
UCW12-1206DH	9...18	±12.0	±230	12.0	80	120	A5
UCW12-1506DH	9...18	±15.0	±190	12.0	80	150	A5
UCW24-0505DH	18...36	±5.0	±500	7.5	78	100	A5
UCW24-1206DH	18...36	±12.0	±230	7.5	81	120	A5
UCW24-1506DH	18...36	±15.0	±190	7.5	81	150	A5
UCW48-0505DH	36...72	±5.0	±500	3.0	78	100	A5
UCW48-1206DH	36...72	±12.0	±230	3.0	81	120	A5
UCW48-1506DH	36...72	±15.0	±190	3.0	81	150	A5
Standard Version:	UCW...06xH	H = 1'500 VDC I/O isolation and metal case				Pinning A4 (s)/ A5 (d)	
Option:	UCW...06xV	V = 3'000 VDC I/O isolation and plastic case				Pinning A4 (s)/ A5 (d)	
	UCW...06xB	B = EMC EN55022 Class B					

7.5 Watt**ECW-Series, 2x1"****2:1 input voltage range DC/DC converter line with single or dual output**

- I/O isolation of 1'500 VDC
- Continuous short circuit proof
- High efficiency
- No derating up to 71 °C
- Low output ripple and noise
- EMC according to EN55022 Class B
- Pi-filter at input
- Metal case with non conductive base plate, six sides shielded
- **Dimensions (LxWxH): 50.8 x 25.4 x 10.2 mm**

Model	U _{in}	U _{out}	I _{out}	No load	η typ.	Ripple	Pinning
Single Output							
	VDC	VDC	mA	mA	%	mV _{p-p}	
ECW12-0307	9...18	3.3	1500	7.5	74	100	B1
ECW12-0507	9...18	5.1	1500	7.5	77	100	B1
ECW12-1207	9...18	12.0	625	7.5	80	120	B1
ECW12-1507	9...18	15.0	500	7.5	80	150	B1
ECW24-0307	18...36	3.3	1500	5.0	76	100	B1
ECW24-0507	18...36	5.1	1500	5.0	78	100	B1
ECW24-1207	18...36	12.0	625	5.0	82	120	B1
ECW24-1507	18...36	15.0	500	5.0	82	150	B1
ECW48-0307	36...72	3.3	1500	3.0	76	100	B1
ECW48-0507	36...72	5.1	1500	2.0	78	100	B1
ECW48-1207	36...72	12.0	625	2.0	81	120	B1
ECW48-1507	36...72	15.0	500	2.0	81	150	B1
Dual Output							
	VDC	VDC	mA	mA	%	mV _{p-p}	
ECW12-050507	9...18	±5.1	±750	7.5	76	100	B2
ECW12-121207	9...18	±12.0	±310	12.0	80	120	B2
ECW12-151507	9...18	±15.0	±250	12.0	80	150	B2
ECW24-050507	18...36	±5.1	±750	7.5	78	100	B2
ECW24-121207	18...36	±12.0	±310	7.5	81	120	B2
ECW24-151507	18...36	±15.0	±250	7.5	81	150	B2
ECW48-050507	36...72	±5.1	±750	3.0	78	100	B2
ECW48-121207	36...72	±12.0	±310	3.0	81	120	B2
ECW48-151507	36...72	±15.0	±250	3.0	81	150	B2
Option:	ECW...07T	T = remote on/off				Pinning see data sheet	

7.5 Watt

ECW-Series, DIL-24

2:1 input voltage range DC/DC converter line with single or dual outputs

- I/O isolation of 1'500 VDC
- Continuous short circuit proof
- No derating up to 71 °C
- Low output ripple and noise
- Pi-filter at input
- Metal case with non conductive base plate, six sides shielded
- UL and cUL1950 certified
- **Dimensions (L x W x H):**
32 x 20 x 10.2 mm



Model	U _{in}	U _{out}	I _{out}	No load	η typ.	Ripple	Pinning
Single Output	VDC	VDC	mA	mA	%	mVpp	
ECW12-0308SH	9...18	3.3	1500	25	74	75	A4
ECW12-0508SH	9...18	5.0	1500	25	78	75	A4
ECW12-1208SH	9...18	12.0	625	25	82	100	A4
ECW12-1508SH	9...18	15.0	500	25	82	100	A4
ECW24-0308SH	18...36	3.3	1500	20	76	75	A4
ECW24-0508SH	18...36	5.0	1500	20	79	75	A4
ECW24-1208SH	18...36	12.0	625	20	82	100	A4
ECW24-1508SH	18...36	15.0	500	20	82	100	A4
ECW48-0308SH	36...72	3.3	1500	10	76	75	A4
ECW48-0508SH	36...72	5.0	1500	10	80	75	A4
ECW48-1208SH	36...72	12.0	625	10	82	100	A4
ECW48-1508SH	36...72	15.0	500	10	82	100	A4
Dual Output	VDC	VDC	mA	mA	%	mVpp	
ECW12-0508DH	9...18	±5.0	±750	30	79	75	A5
ECW12-1208DH	9...18	±12.0	±310	30	83	100	A5
ECW12-1508DH	9...18	±15.0	±250	30	83	100	A5
ECW24-0508DH	18...36	±5.0	±750	25	81	75	A5
ECW24-1208DH	18...36	±12.0	±310	25	83	100	A5
ECW24-1508DH	18...36	±15.0	±250	25	83	100	A5
ECW48-0508DH	36...72	±5.0	±750	15	81	75	A5
ECW48-1208DH	36...72	±12.0	±310	15	83	100	A5
ECW48-1508DH	36...72	±15.0	±250	15	83	100	A5

7.5 Watt

ECW-Series, SMD

2:1 input voltage range DC/DC converter line with single or dual outputs

- I/O isolation of 1'500 VDC
- Continuous short circuit proof
- No derating up to 71 °C
- Low output ripple and noise
- Pi-filter at input
- Metal case with non conductive base plate, six sides shielded
- UL and cUL1950 certified
- **Dimensions (L x W x H):**
32 x 20 x 11.4 mm



Model	U _{in}	U _{out}	I _{out}	No load	η typ.	Ripple	Pinning
Single Output	VDC	VDC	mA	mA	%	mVpp	
ECW12-0308SH-S	9...18	3.3	1500	25	74	75	AS4
ECW12-0508SH-S	9...18	5.0	1500	25	78	75	AS4
ECW12-1208SH-S	9...18	12.0	625	25	82	100	AS4
ECW12-1508SH-S	9...18	15.0	500	25	82	100	AS4
ECW24-0308SH-S	18...36	3.3	1500	20	76	75	AS4
ECW24-0508SH-S	18...36	5.0	1500	20	79	75	AS4
ECW24-1208SH-S	18...36	12.0	625	20	82	100	AS4
ECW24-1508SH-S	18...36	15.0	500	20	82	100	AS4
ECW48-0308SH-S	36...72	3.3	1500	10	76	75	AS4
ECW48-0508SH-S	36...72	5.0	1500	10	80	75	AS4
ECW48-1208SH-S	36...72	12.0	625	10	82	100	AS4
ECW48-1508SH-S	36...72	15.0	500	10	82	100	AS4
Dual Output	VDC	VDC	mA	mA	%	mVpp	
ECW12-0508DH-S	9...18	±5.0	±750	30	79	75	AS5
ECW12-1208DH-S	9...18	±12.0	±310	30	83	100	AS5
ECW12-1508DH-S	9...18	±15.0	±250	30	83	100	AS5
ECW24-0508DH-S	18...36	±5.0	±750	25	81	75	AS5
ECW24-1208DH-S	18...36	±12.0	±310	25	83	100	AS5
ECW24-1508DH-S	18...36	±15.0	±250	25	83	100	AS5
ECW48-0508DH-S	36...72	±5.0	±750	15	81	75	AS5
ECW48-1208DH-S	36...72	±12.0	±310	15	83	100	AS5
ECW48-1508DH-S	36...72	±15.0	±250	15	83	100	AS5

8 Watt**ECU-Series****4:1 input voltage range DC/DC converter line with single or dual outputs**

- I/O isolation of 1'500 VDC
- Continuous short circuit proof
- High efficiency
- No derating up to 71 °C
- Pi-filter at input
- Metal case with non conductive base plate, six sides shielded or non conductive plastic case
- **Dimensions (L x W x H): 32 x 20 x 10.2 mm**

Model	U _{in}	U _{out}	I _{out}	No load	η typ.	Ripple	Pinning
Single Output	VDC	VDC	mA	mA	%	mVpp	
ECU24-0308SH	9...36	3.3	2000	10	80	75	A9
ECU24-0508SH	9...36	5.0	1600	10	82	75	A9
ECU24-1208SH	9...36	12.0	666	10	85	100	A9
ECU24-1508SH	9...36	15.0	530	10	85	100	A9
ECU48-0308SH	18...72	3.3	2000	5	80	75	A9
ECU48-0508SH	18...72	5.0	1600	5	83	75	A9
ECU48-1208SH	18...72	12.0	666	5	86	100	A9
ECU48-1508SH	18...72	15.0	530	5	86	100	A9
Dual Output	VDC	VDC	mA	mA	%	mVpp	
ECU24-0508DH	9...36	± 5.0	± 800	10	82	75	A10
ECU24-1208DH	9...36	± 12.0	± 333	10	85	100	A10
ECU24-1508DH	9...36	± 15.0	± 265	10	85	100	A10
ECU48-0508DH	18...72	± 5.0	± 800	5	83	75	A10
ECU48-1208DH	18...72	± 12.0	± 333	5	86	100	A10
ECU48-1508DH	18...72	± 15.0	± 265	5	86	100	A10
Standard Version:	ECU...-.06xH	H = 1'500 VDC I/O isolation and metal case				Pinning A4 (s)/ A5 (d)	
Option:	ECU...-.06xV	V = 3'000 VDC I/O isolation and plastic case				Pinning A4 (s)/ A5 (d)	

8 Watt**ECU-Series, SMD****4:1 input voltage range DC/DC converter line with single or dual outputs**

- I/O isolation of 1'500 VDC
- Continuous short circuit proof
- High efficiency
- No derating up to 71 °C
- Pi-filter at input
- Metal case with non conductive base plate, six sides shielded or non conductive plastic case
- **Dimensions (L x W x H): 32 x 20 x 11.4 mm**

Model	U _{in}	U _{out}	I _{out}	No load	η typ.	Ripple	Pinning
Single Output	VDC	VDC	mA	mA	%	mVpp	
ECU24-0308SH-S	9...36	3.3	2000	10	80	75	AS9
ECU24-0508SH-S	9...36	5.0	1600	10	82	75	AS9
ECU24-1208SH-S	9...36	12.0	666	10	85	100	AS9
ECU24-1508SH-S	9...36	15.0	530	10	85	100	AS9
ECU48-0308SH-S	18...72	3.3	2000	5	80	75	AS9
ECU48-0508SH-S	18...72	5.0	1600	5	83	75	AS9
ECU48-1208SH-S	18...72	12.0	666	5	86	100	AS9
ECU48-1508SH-S	18...72	15.0	530	5	86	100	AS9
Dual Output	VDC	VDC	mA	mA	%	mVpp	
ECU24-0508DH-S	9...36	± 5.0	± 800	10	82	75	AS10
ECU24-1208DH-S	9...36	± 12.0	± 333	10	85	100	AS10
ECU24-1508DH-S	9...36	± 15.0	± 265	10	85	100	AS10
ECU48-0508DH-S	18...72	± 5.0	± 800	5	83	75	AS10
ECU48-1208DH-S	18...72	± 12.0	± 333	5	86	100	AS10
ECU48-1508DH-S	18...72	± 15.0	± 265	5	86	100	AS10
Standard Version:	ECU...-.06xH	H = 1'500 VDC I/O isolation and metal case				Pinning A4 (s)/ A5 (d)	
Option:	ECU...-.06xV	V = 3'000 VDC I/O isolation and plastic case				Pinning A4 (s)/ A5 (d)	

10 Watt**ECU-Series****4:1 input voltage range DC/DC converter line with single or dual outputs**

- I/O isolation of 500 VDC
- Continuous short circuit proof
- High efficiency
- No derating up to 71 °C
- Low output ripple and noise
- EMC according to EN55022 Class A
- Pi-filter at input
- Metal case with non conductive base plate, six sides shielded
- **Dimensions (L x W x H): 50.8 x 25.4 x 10.2 mm**

Model	Uin	Uout	Iout	No load	η typ.	Ripple	Pinning
Single Output	VDC	VDC	mA	mA	%	mVpp	
ECU24-0310	9...36	3.3	2000	15	76	75	B1
ECU24-0510	9...36	5.1	2000	15	77	75	B1
ECU24-1210	9...36	12.0	830	15	80	75	B1
ECU24-1510	9...36	15.0	666	15	80	75	B1
ECU48-0310	18...72	3.3	2000	15	76	75	B1
ECU48-0510	18...72	5.1	2000	10	78	75	B1
ECU48-1210	18...72	12.0	830	10	80	75	B1
ECU48-1510	18...72	15.0	666	10	80	75	B1
Dual Output	VDC	VDC	mA	mA	%	mVpp	
ECU24-050510	9...36	± 5.1	± 1000	20	80	75	B2
ECU24-121210	9...36	± 12.0	± 415	20	80	75	B2
ECU24-151510	9...36	± 15.0	± 333	20	80	75	B2
ECU48-050510	18...72	± 5.1	± 1000	15	82	75	B2
ECU48-121210	18...72	± 12.0	± 415	15	82	75	B2
ECU48-151510	18...72	± 15.0	± 333	15	82	75	B2

Upon request a version with 1'500 VDC isolation voltage is available

10 Watt**ECU-Series, 1x1"****4:1 input voltage range DC/DC converter line with single or dual outputs**

- I/O isolation of 1'500 VDC
- Continuous short circuit proof
- High efficiency up to 86 %
- Remote on/off function
- Fixed switching frequency
- Regulated outputs
- Input under voltage protection
- **Dimensions (L x W x H): 25.4 x 25.4 x 10.2 mm**

Model	Uin	Uout	Iout	No load	η typ.	Ripple	Pinning
Single Output	VDC	VDC	mA	mA	%	mVpp	
ECU24-0510SB	9...36	5.0	2000	10	83	75	SB1
ECU24-1210SB	9...36	12.0	835	10	85	100	SB1
ECU24-1510SB	9...36	15.0	666	10	85	100	SB1
ECU24-3V310SB	9...36	3.3	2500	10	82	75	SB1
ECU48-0510SB	18...72	5.0	2000	5	84	75	SB1
ECU48-1210SB	18...72	12.0	835	5	86	100	SB1
ECU48-1510SB	18...72	15.0	666	5	86	100	SB1
ECU48-3V310SB	18...72	3.3	2500	5	83	75	SB1
Dual Output	VDC	VDC	mA	mA	%	mVpp	
ECU24-050510SB	9...36	± 5.0	± 1000	10	84	75	SB2
ECU24-121210SB	9...36	± 12.0	± 416	10	85	100	SB2
ECU24-151510SB	9...36	± 12.0	± 333	10	85	100	SB2
ECU48-050510SB	18...72	± 5.0	± 1000	5	84	75	SB2
ECU48-121210SB	18...72	± 12.0	± 416	5	86	100	SB2
ECU48-151510SB	18...72	± 12.0	± 333	5	86	100	SB2

10 Watt**ECW-Series****2:1 input voltage range DC/DC converter line with single or dual outputs**

- I/O isolation of 500 VDC
- Continuous short circuit proof
- High efficiency
- No derating up to 71 °C
- Low output ripple and noise
- EMC according to EN55022 Class A
- Pi-filter at input
- Low silhouette
- Metal case with non conductive base plate, six sides shielded
- **Dimensions (L x W x H): 50.8 x 25.4 x 10.2 mm**

Model	U _{in}	U _{out}	I _{out}	No load	η typ.	Ripple	Pinning
Single Output							
	VDC	VDC	mA	mA	%	mVpp	
ECW05-0510	4.7...9	5.1	1600	15	75	100	B1
ECW05-1210	4.7...9	12.0	666	15	76	100	B1
ECW05-1510	4.7...9	15.0	533	15	76	100	B1
ECW12-0510	9...18	5.1	2000	30	76	100	B1
ECW12-1210	9...18	12.0	830	30	78	100	B1
ECW12-1510	9...18	15.0	666	30	78	100	B1
ECW24-0510	18...36	5.1	2000	20	78	100	B1
ECW24-1210	18...36	12.0	830	20	80	100	B1
ECW24-1510	18...36	15.0	666	20	80	100	B1
ECW48-0510	36...72	5.1	2000	10	80	100	B1
ECW48-1210	36...72	12.0	830	10	82	100	B1
ECW48-1510	36...72	15.0	666	10	82	100	B1
Dual Output							
	VDC	VDC	mA	mA	%	mVpp	
ECW05-050510	4.7...9.0	±5.1	±800	15	76	100	B2
ECW05-121210	4.7...9.0	±12.0	±333	15	76	100	B2
ECW05-151510	4.7...9.0	±15.0	±266	15	76	100	B2
ECW12-050510	9...18	±5.1	±1000	40	78	100	B2
ECW12-121210	9...18	±12.0	±415	40	78	100	B2
ECW12-151510	9...18	±15.0	±333	40	78	100	B2
ECW24-050510	18...36	±5.1	±1000	20	80	100	B2
ECW24-121210	18...36	±12.0	±415	20	80	100	B2
ECW24-151510	18...36	±15.0	±333	20	80	100	B2
ECW48-050510	36...72	±5.1	±1000	10	82	100	B2
ECW48-121210	36...72	±12.0	±415	10	82	100	B2
ECW48-151510	36...72	±15.0	±333	10	82	100	B2

Upon request a version with 1'500 VDC isolation voltage is available

10 Watt

ECW-Series, 1x1"



2:1 input voltage range DC/DC converter line

- I/O isolation of 1'500 VDC
- Continuous short circuit proof
- High efficiency
- No derating up to 71 °C
- Low output ripple and noise
- Input under-voltage Protection
- Remote on/off
- Over Current Protection
- **Dimensions (L x W x H): 25.4 x 25.4 x 10.2 mm**

Model	U _{in}	U _{out}	I _{out}	No load	η typ.	Ripple	Pinning
Single Output	VDC	VDC	mA	mA	%	mVpp	
ECW05-0310SB	4.7...9	3.3	2500	120	83	50	SB1
ECW05-0510SB	4.7...9	5.0	2000	120	85	50	SB1
ECW05-1210SB	4.7...9	12.0	833	50	87	50	SB1
ECW05-1510SB	4.7...9	15.0	666	50	87	50	SB1
ECW12-0310SB	9...18	3.3	2500	30	82	50	SB1
ECW12-0510SB	9...18	5.0	2000	30	85	50	SB1
ECW12-1210SB	9...18	12.0	833	30	87	50	SB1
ECW12-1510SB	9...18	15.0	666	35	87	50	SB1
ECW24-0310SB	18...36	3.3	2500	20	82	50	SB1
ECW24-0510SB	18...36	5.0	2000	20	85	50	SB1
ECW24-1210SB	18...36	12.0	833	20	87	50	SB1
ECW24-1510SB	18...36	15.0	666	20	87	50	SB1
ECW48-0310SB	36...72	3.3	2500	20	81	50	SB1
ECW48-0510SB	36...72	5.0	2000	20	85	50	SB1
ECW48-1210SB	36...72	12.0	833	20	87	50	SB1
ECW48-1510SB	36...72	15.0	666	20	87	50	SB1
Dual Output	VDC	VDC	mA	mA	%	mVpp	
ECW05-0510DB	4.7...9	±5.0	±1000	50	84	50	SB2
ECW05-1210DB	4.7...9	±12.0	±416	50	87	50	SB2
ECW05-1510DB	4.7...9	±15.0	±333	50	87	50	SB2
ECW12-0510DB	9...18	±5.0	±1000	45	85	50	SB2
ECW12-1210DB	9...18	±12.0	±416	45	87	50	SB2
ECW12-1510DB	9...18	±15.0	±333	45	87	50	SB2
ECW24-0510DB	18...36	±5.0	±1000	30	85	50	SB2
ECW24-1210DB	18...36	±12.0	±416	25	87	50	SB2
ECW24-1510DB	18...36	±15.0	±333	25	87	50	SB2
ECW48-0510DB	36...72	±5.0	±1000	20	85	50	SB2
ECW48-1210DB	36...72	±12.0	±416	20	87	50	SB2
ECW48-1510DB	36...72	±15.0	±333	20	87	50	SB2

10 Watt**ECW-Series, 1x1" SMD****2:1 input voltage range DC/DC converter line**

- I/O isolation of 1'500 VDC
- Continuous short circuit proof
- High efficiency
- No derating up to 71 °C
- Low output ripple and noise
- Input under-voltage Protection
- Remote on/off
- Over Current Protection
- **Dimensions (L x W x H): 25.4 x 25.4 x 9.2 mm**

Model	U _{in}	U _{out}	I _{out}	No load	η typ.	Ripple	Pinning
Single Output	VDC	VDC	mA	mA	%	mVpp	
ECW05-0310SB-S	4.7...9	3.3	2500	120	83	50	SBS1
ECW05-0510SB-S	4.7...9	5.0	2000	120	85	50	SBS1
ECW05-1210SB-S	4.7...9	12.0	833	50	87	50	SBS1
ECW05-1510SB-S	4.7...9	15.0	666	50	87	50	SBS1
ECW12-0310SB-S	9...18	3.3	2500	30	82	50	SBS1
ECW12-0510SB-S	9...18	5.0	2000	30	85	50	SBS1
ECW12-1210SB-S	9...18	12.0	833	30	87	50	SBS1
ECW12-1510SB-S	9...18	15.0	666	35	87	50	SBS1
ECW24-0310SB-S	18...36	3.3	2500	20	82	50	SBS1
ECW24-0510SB-S	18...36	5.0	2000	20	85	50	SBS1
ECW24-1210SB-S	18...36	12.0	833	20	87	50	SBS1
ECW24-1510SB-S	18...36	15.0	666	20	87	50	SBS1
ECW48-0310SB-S	36...72	3.3	2500	20	81	50	SBS1
ECW48-0510SB-S	36...72	5.0	2000	20	85	50	SBS1
ECW48-1210SB-S	36...72	12.0	833	20	87	50	SBS1
ECW48-1510SB-S	36...72	15.0	666	20	87	50	SBS1
Dual Output	VDC	VDC	mA	mA	%	mVpp	
ECW05-0510DB-S	4.7...9	±5.0	±1000	50	84	50	SBS2
ECW05-1210DB-S	4.7...9	±12.0	±416	50	87	50	SBS2
ECW05-1510DB-S	4.7...9	±15.0	±333	50	87	50	SBS2
ECW12-0510DB-S	9...18	±5.0	±1000	45	85	50	SBS2
ECW12-1210DB-S	9...18	±12.0	±416	45	87	50	SBS2
ECW12-1510DB-S	9...18	±15.0	±333	45	87	50	SBS2
ECW24-0510DB-S	18...36	±5.0	±1000	30	85	50	SBS2
ECW24-1210DB-S	18...36	±12.0	±416	25	87	50	SBS2
ECW24-1510DB-S	18...36	±15.0	±333	25	87	50	SBS2
ECW48-0510DB-S	36...72	±5.0	±1000	20	85	50	SBS2
ECW48-1210DB-S	36...72	±12.0	±416	20	87	50	SBS2
ECW48-1510DB-S	36...72	±15.0	±333	20	87	50	SBS2

10 Watt

ECW-Series, DIL-24



2:1 input voltage range DC/DC converter line with single or dual output

- Very high efficiency up to 89 %
- I/O isolation of 1'500 VDC
- No tantalum capacitors
- High power density
- Continuous short circuit proof
- Derating from 71 °C
- Low output ripple and noise
- EMC according to EN55022 Class A
- UL and cUL 60950 certified
- Pi-filter at input
- Metal case with non conductive base plate
- **Dimensions (L x W x H): 32 x 20 x 10.2 mm**

Model	U _{in}	U _{out}	I _{out}	No load	η typ.	Ripple	Pinning
Single Output	VDC	VDC	mA	mA	%	mVpp	
ECW12-2V510ASH	9...18	2.5	3000	40	83	75	A9
ECW12-3V310ASH	9...18	3.3	3000	40	85	75	A9
ECW12-0510ASH	9...18	5.0	2000	40	87	75	A9
ECW12-1210ASH	9...18	12.0	835	40	88	75	A9
ECW12-1510ASH	9...18	15.0	666	40	88	75	A9
ECW24-2V510ASH	18...36	2.5	3000	30	85	75	A9
ECW24-3V310ASH	18...36	3.3	3000	30	86	75	A9
ECW24-0510ASH	18...36	5.0	2000	30	88	75	A9
ECW24-1210ASH	18...36	12.0	835	30	89	75	A9
ECW24-1510ASH	18...36	15.0	666	30	89	75	A9
ECW48-2V510ASH	36...72	2.5	3000	15	85	75	A9
ECW48-3V310ASH	36...72	3.3	3000	15	86	75	A9
ECW48-0510ASH	36...72	5.0	2000	15	87	75	A9
ECW48-1210ASH	36...72	12.0	835	15	89	75	A9
ECW48-1510ASH	36...72	15.0	666	15	88	75	A9
Dual Output	VDC	VDC	mA	mA	%	mVpp	
ECW12-1210ADH	9...18	±12.0	±416	20	87	100	A10
ECW12-1510ADH	9...18	±15.0	±333	20	86	100	A10
ECW24-1210ADH	18...36	±12.0	±416	20	88	100	A10
ECW24-1510ADH	18...36	±15.0	±333	20	87	100	A10
ECW48-1210ADH	36...72	±12.0	±416	10	88	100	A10
ECW48-1510ADH	36...72	±15.0	±333	10	87	100	A10

10 Watt

ECW-Series, SMD



2:1 input voltage range DC/DC converter line with single or dual output

- Very high efficiency up to 89 %
- I/O isolation of 1'500 VDC
- No tantalum capacitors
- High power density
- Continuous short circuit proof
- Derating from 71 °C
- Low output ripple and noise
- EMC according to EN55022 Class A
- UL and cUL 60950 certified
- Pi-filter at input
- Metal case with non conductive base plate
- **Dimensions (L x W x H): 32 x 20 x 11.4 mm**

Model	U _{in}	U _{out}	I _{out}	No load	η typ.	Ripple	Pinning
Single Output	VDC	VDC	mA	mA	%	mVpp	
ECW12-2V510ASH-S	9...18	2.5	3000	40	83	75	AS9
ECW12-3V310ASH-S	9...18	3.3	3000	40	85	75	AS9
ECW12-0510ASH-S	9...18	5.0	2000	40	87	75	AS9
ECW12-1210ASH-S	9...18	12.0	835	40	88	75	AS9
ECW12-1510ASH-S	9...18	15.0	666	40	88	75	AS9
ECW24-2V510ASH-S	18...36	2.5	3000	30	85	75	AS9
ECW24-3V310ASH-S	18...36	3.3	3000	30	86	75	AS9
ECW24-0510ASH-S	18...36	5.0	2000	30	88	75	AS9
ECW24-1210ASH-S	18...36	12.0	835	30	89	75	AS9
ECW24-1510ASH-S	18...36	15.0	666	30	89	75	AS9
ECW48-2V510ASH-S	36...72	2.5	3000	15	85	75	AS9
ECW48-3V310ASH-S	36...72	3.3	3000	15	86	75	AS9
ECW48-0510ASH-S	36...72	5.0	2000	15	87	75	AS9
ECW48-1210ASH-S	36...72	12.0	835	15	89	75	AS9
ECW48-1510ASH-S	36...72	15.0	666	15	88	75	AS9
Dual Output	VDC	VDC	mA	mA	%	mVpp	
ECW12-1210ADH-S	9...18	±12.0	±416	20	87	100	AS10
ECW12-1510ADH-S	9...18	±15.0	±333	20	86	100	AS10
ECW24-1210ADH-S	18...36	±12.0	±416	20	88	100	AS10
ECW24-1510ADH-S	18...36	±15.0	±333	20	87	100	AS10
ECW48-1210ADH-S	36...72	±12.0	±416	10	88	100	AS10
ECW48-1510ADH-S	36...72	±15.0	±333	10	87	100	AS10

10 Watt**UCW-Series****2:1 input voltage range DC/DC converter line with single or dual output**

- I/O isolation of 500 VDC
- Continuous short circuit proof
- High efficiency
- No derating up to 71 °C
- Low output ripple and noise
- EMC according to EN55022 Class A
- Pi-filter at input
- Metal case with non conductive base plate, six sides shielded
- UL and cUL 1950 certified
- **Dimensions (L x W x H): 50.8 x 25.4 x 10.2 mm**



Model	U _{in}	U _{out}	I _{out}	No load	η typ.	Ripple	Pinning
Single Output							
	VDC	VDC	mA	mA	%	mVpp	
UCW12-0510	9...18	5.1	2000	30	76	100	B1
UCW12-1210	9...18	12.0	830	30	78	100	B1
UCW12-1510	9...18	15.0	666	30	78	100	B1
UCW24-0510	18...36	5.1	2000	20	78	100	B1
UCW24-1210	18...36	12.0	830	20	80	100	B1
UCW24-1510	18...36	15.0	666	20	80	100	B1
UCW48-0510	36...72	5.1	2000	10	80	100	B1
UCW48-1210	36...72	12.0	830	10	82	100	B1
UCW48-1510	36...72	15.0	666	10	82	100	B1
Dual Output							
	VDC	VDC	mA	mA	%	mVpp	
UCW12-050510	9...18	±5.1	±1000	40	78	100	B2
UCW12-121210	9...18	±12.0	±415	40	78	100	B2
UCW12-151510	9...18	±15.0	±333	40	78	100	B2
UCW24-050510	18...36	±5.1	±1000	20	80	100	B2
UCW24-121210	18...36	±12.0	±415	20	80	100	B2
UCW24-151510	18...36	±15.0	±333	20	80	100	B2
UCW48-050510	36...72	±5.1	±1000	10	82	100	B2
UCW48-121210	36...72	±12.0	±415	10	82	100	B2
UCW48-151510	36...72	±15.0	±333	10	82	100	B2

15 Watt**ECU-Series, 1x1"****4:1 input voltage range DC/DC converter line with single or dual outputs**

- I/O isolation of 1'500 VDC
- Continuous short circuit proof
- High efficiency up to 88 %
- Remote on/off function
- Fixed switching frequency
- Regulated outputs
- Input under voltage protection
- **Dimensions (L x W x H): 25.4 x 25.4 x 10.2 mm**

Model	U _{in}	U _{out}	I _{out}	No load	η typ.	Ripple	Pinning
Single Output							
	VDC	VDC	mA	mA	%	mVpp	
ECU24-3V315SB	9...36	3.3	4000	50	85	75	SB1
ECU24-0515SB	9...36	5.0	3000	50	87	75	SB1
ECU24-1215SB	9...36	12.0	1250	50	87	100	SB1
ECU24-1515SB	9...36	15.0	1000	50	87	100	SB1
ECU48-3V315SB	18...72	3.3	4000	25	86	75	SB1
ECU48-0515SB	18...72	5.0	3000	25	88	75	SB1
ECU48-1215SB	18...72	12.0	1250	25	88	100	SB1
ECU48-1515SB	18...72	15.0	1000	25	88	100	SB1
Dual Output							
	VDC	VDC	mA	mA	%	mVpp	
ECU24-050515SB	9...36	±5.0	±1500	50	87	75	SB2
ECU24-121215SB	9...36	±12.0	±625	50	87	100	SB2
ECU24-151515SB	9...36	±15.0	±500	50	88	100	SB2
ECU48-050515SB	18...72	±5.0	±1500	25	88	75	SB2
ECU48-121215SB	18...72	±12.0	±625	25	88	100	SB2
ECU48-151515SB	18...72	±15.0	±500	25	88	100	SB2

15 Watt**ECU-Series, 1x1" SMD****4:1 input voltage range DC/DC converter line with single or dual outputs**

- I/O isolation of 1'500 VDC
- Continuous short circuit proof
- High efficiency up to 88 %
- Remote on/off function
- Fixed switching frequency
- Regulated outputs
- Input under voltage protection
- **Dimensions (L x W x H): 25.4 x 25.4 x 12 mm**

Model	U _{in}	U _{out}	I _{out}	No load	η typ.	Ripple	Pinning
Single Output	VDC	VDC	mA	mA	%	mV _{pp}	
ECU24-3V315SB-S	9...36	3.3	4000	50	85	75	SBS1
ECU24-0515SB-S	9...36	5.0	3000	50	87	75	SBS1
ECU24-1215SB-S	9...36	12.0	1250	50	87	100	SBS1
ECU24-1515SB-S	9...36	15.0	1000	50	87	100	SBS1
ECU48-3V315SB-S	18...72	3.3	4000	25	86	75	SBS1
ECU48-0515SB-S	18...72	5.0	3000	25	88	75	SBS1
ECU48-1215SB-S	18...72	12.0	1250	25	88	100	SBS1
ECU48-1515SB-S	18...72	15.0	1000	25	88	100	SBS1
Dual Output	VDC	VDC	mA	mA	%	mV _{pp}	
ECU24-050515SB-S	9...36	±5.0	±1500	50	87	75	SBS2
ECU24-121215SB-S	9...36	±12.0	±625	50	87	100	SBS2
ECU24-151515SB-S	9...36	±15.0	±500	50	88	100	SBS2
ECU48-050515SB-S	18...72	±5.0	±1500	25	88	75	SBS2
ECU48-121215SB-S	18...72	±12.0	±625	25	88	100	SBS2
ECU48-151515SB-S	18...72	±15.0	±500	25	88	100	SBS2

15 Watt**ECU-Series, 2x2"****4:1 input voltage range DC/DC converter with up to 3 outputs**

- I/O isolation of 500 VDC
- Continuous short circuit proof
- High efficiency
- Remote on/off control
- External output voltage adjustment ±10 %
- No derating up to 71 °C
- Low output ripple and noise
- Pi-filter at input
- Low silhouette
- Metal case with non conductive base plate, six sides shielded
- **Dimensions (L x W x H): 50.8 x 50.8 x 10.2 mm**

Model	U _{in}	U _{out}	I _{out}	No load	η typ.	Ripple	Pinning
Single Output	VDC	VDC	mA	mA	%	mV _{pp}	
ECU24-0315	9...36	3.3	3000	15	76	75	C5
ECU24-0515	9...36	5.1	3000	15	77	75	C5
ECU24-1215	9...36	12.0	1250	15	80	75	C5
ECU24-1515	9...36	15.0	1000	15	80	75	C5
ECU48-0315	18...72	3.3	3000	10	76	75	C5
ECU48-0515	18...72	5.1	3000	10	77	75	C5
ECU48-1215	18...72	12.0	1250	10	80	75	C5
ECU48-1515	18...72	15.0	1000	10	80	75	C5
Dual Output	VDC	VDC	mA	mA	%	mV _{pp}	
ECU24-050515	9...36	±5.1	±1500	20	77	75	C6
ECU24-121215	9...36	±12.0	±625	20	80	75	C6
ECU24-151515	9...36	±15.0	±500	20	80	75	C6
ECU48-050515	18...72	±5.1	±1500	15	79	75	C6
ECU48-121215	18...72	±12.0	±625	15	82	75	C6
ECU48-151515	18...72	±15.0	±500	15	82	75	C6
Triple Output	VDC	VDC	mA	mA	%	mV _{pp}	
ECU24-512T15	9...36	5.1/±12.0	1500/±310	20	80	75	C7
ECU24-515T15	9...36	5.1/±15.0	1500/±250	20	80	75	C7
ECU48-512T15	18...72	5.1/±12.0	1500/±310	15	82	75	C7
ECU48-515T15	18...72	5.1/±15.0	1500/±250	15	82	75	C7

15 Watt

ECW-Series, 1x1"



2:1 input voltage range DC/DC converter line

- I/O isolation of 1'500 VDC
- Continuous short circuit proof
- High efficiency
- No derating up to 71 °C
- Input under-voltage Protection
- Over Current Protection
- Remote on/off
- **Dimensions (L x W x H): 25.4 x 25.4 x 10.2 mm**

Model	U _{in}	U _{out}	I _{out}	No load	η typ.	Ripple	Pinning
Single Output	VDC	VDC	mA	mA	%	mVpp	
ECW12-0315SB	9...18	3.3	4000	90	85	50	SB1
ECW12-0515SB	9...18	5.0	3000	85	88	50	SB1
ECW12-1215SB	9...18	12.0	1250	70	88	50	SB1
ECW12-1515SB	9...18	12.0	1000	70	88	50	SB1
ECW24-0315SB	18...36	3.3	4000	50	86	50	SB1
ECW24-0515SB	18...36	5.0	3000	50	89	50	SB1
ECW24-1215SB	18...36	12.0	1250	20	90	50	SB1
ECW24-1515SB	18...36	15.0	1000	20	90	50	SB1
ECW48-0315SB	36...72	3.3	4000	25	86	50	SB1
ECW48-0515SB	36...72	5.0	3000	30	88	50	SB1
ECW48-1215SB	36...72	12.0	1250	20	90	50	SB1
ECW48-1515SB	36...72	15.0	1000	20	90	50	SB1
Dual Output	VDC	VDC	mA	mA	%	mVpp	
ECW12-050515SB	9...18	±5.0	±1500	45	85	50	SB2
ECW12-121215SB	9...18	±12.0	±625	45	87	50	SB2
ECW12-151515SB	9...18	±12.0	±500	45	88	50	SB2
ECW24-050515SB	18...36	±5.0	±1500	25	86	50	SB2
ECW24-121215SB	18...36	±12.0	±625	25	88	50	SB2
ECW24-151515SB	18...36	±15.0	±500	25	89	50	SB2
ECW48-050515SB	36...75	±5.0	±1500	20	86	50	SB2
ECW48-121215SB	36...75	±12.0	±625	20	88	50	SB2
ECW48-151515SB	36...75	±15.0	±500	20	89	50	SB2

15 Watt

ECW-Series, 1x1" SMD



2:1 input voltage range DC/DC converter line

- I/O isolation of 1'500 VDC
- Continuous short circuit proof
- High efficiency
- No derating up to 71 °C
- Input under-voltage Protection
- Over Current Protection
- Remote on/off
- **Dimensions (L x W x H): 25.4 x 25.4 x 9.2 mm**

Model	U _{in}	U _{out}	I _{out}	No load	η typ.	Ripple	Pinning
Single Output	VDC	VDC	mA	mA	%	mVpp	
ECW12-0315SB-S	9...18	3.3	4000	90	85	120	SBS1
ECW12-0515SB-S	9...18	5.0	3000	85	88	120	SBS1
ECW12-1215SB-S	9...18	12.0	1250	70	88	120	SBS1
ECW12-1515SB-S	9...18	12.0	1000	70	88	120	SBS1
ECW24-0315SB-S	18...36	3.3	4000	50	86	120	SBS1
ECW24-0515SB-S	18...36	5.0	3000	50	89	120	SBS1
ECW24-1215SB-S	18...36	12.0	1250	20	90	120	SBS1
ECW24-1515SB-S	18...36	15.0	1000	20	90	120	SBS1
ECW48-0315SB-S	36...72	3.3	4000	25	86	120	SBS1
ECW48-0515SB-S	36...72	5.0	3000	30	88	120	SBS1
ECW48-1215SB-S	36...72	12.0	1250	20	90	120	SBS1
ECW48-1515SB-S	36...72	15.0	1000	20	90	120	SBS1
Dual Output	VDC	VDC	mA	mA	%	mVpp	
ECW12-050515SB-S	9...18	±5.0	±1500	45	85	120	SBS2
ECW12-121215SB-S	9...18	±12.0	±625	45	87	120	SBS2
ECW12-151515SB-S	9...18	±12.0	±500	45	88	120	SBS2
ECW24-050515SB-S	18...36	±5.0	±1500	25	86	120	SBS2
ECW24-121215SB-S	18...36	±12.0	±625	25	88	120	SBS2
ECW24-151515SB-S	18...36	±15.0	±500	25	89	120	SBS2
ECW48-050515SB-S	36...75	±5.0	±1500	20	86	120	SBS2
ECW48-121215SB-S	36...75	±12.0	±625	20	88	120	SBS2
ECW48-151515SB-S	36...75	±15.0	±500	20	89	120	SBS2

15 Watt

ECW-Series, 2x1"

2:1 input voltage range DC/DC converter line with single or dual output

- I/O isolation of 500 VDC
- Continuous short circuit proof
- High efficiency
- No derating up to 71 °C
- Remote on/off control optional
- External output voltage adjustment $\pm 10\%$ optional
- Pi-filter at input
- Metal case with non conductive base plate, six sides shielded
- **Dimensions (L x W x H): 50.8 x 25.4 x 10.2 mm**

Model	U _{in}	U _{out}	I _{out}	No load	η typ.	Ripple	Pinning
Single Output							
	VDC	VDC	mA	mA	%	mV _{pp}	
ECW12-0315B	9...18	3.3	3000	20	76	100	B1
ECW12-0515B	9...18	5.1	3000	20	77	100	B1
ECW12-1215B	9...18	12.0	1250	20	80	100	B1
ECW12-1515B	9...18	15.0	1000	20	80	100	B1
ECW24-0315B	18...36	3.3	3000	20	76	100	B1
ECW24-0515B	18...36	5.1	3000	20	78	100	B1
ECW24-1215B	18...36	12.0	1250	20	80	100	B1
ECW24-1515B	18...36	15.0	1000	20	80	100	B1
ECW48-0315B	36...72	3.3	3000	10	76	100	B1
ECW48-0515B	36...72	5.1	3000	10	80	100	B1
ECW48-1215B	36...72	12.0	1250	10	82	100	B1
ECW48-1515B	36...72	15.0	1000	10	82	100	B1
Dual Output							
	VDC	VDC	mA	mA	%	mV _{pp}	
ECW12-050515B	9...18	± 5.1	± 1500	30	80	100	B2
ECW12-121215B	9...18	± 12.0	± 625	30	80	100	B2
ECW12-151515B	9...18	± 15.0	± 500	30	80	100	B2
ECW24-050515B	18...36	± 5.1	± 1500	30	80	100	B2
ECW24-121215B	18...36	± 12.0	± 625	30	80	100	B2
ECW24-151515B	18...36	± 15.0	± 500	30	80	100	B2
ECW48-050515B	36...72	± 5.1	± 1500	15	82	100	B2
ECW48-121215B	36...72	± 12.0	± 625	15	82	100	B2
ECW48-151515B	36...72	± 15.0	± 500	15	82	100	B2
Option:	ECW...15BT	T = remote on/off				Pinning see data sheet	
	ECW...15BA	A = ext. output voltage adjustment $\pm 10\%$, only for single output				Pinning see data sheet	

15 Watt

ECW-Series, 2x2"

2:1 input voltage range DC/DC converter line with single or dual output

- I/O isolation of 500 VDC
- Continuous short circuit proof
- High efficiency
- No derating up to 71 °C
- Low output ripple and noise
- EMC according to EN55022 Class B
- Pi-filter at input
- Metal case with non conductive base plate, six sides shielded
- **Dimensions (L x W x H): 50.8 x 50.8 x 10.2 mm**

Model	U _{in}	U _{out}	I _{out}	No load	η typ.	Ripple	Pinning
Single Output							
	VDC	VDC	mA	mA	%	mV _{pp}	
ECW12-0315	9...18	3.3	3000	30	70	75	C1
ECW12-0515	9...18	5.1	3000	30	75	75	C1
ECW12-1215	9...18	12.0	1250	30	78	75	C1
ECW12-1515	9...18	15.0	1000	30	78	75	C1
ECW24-0315	18...36	3.3	3000	15	74	75	C1
ECW24-0515	18...36	5.1	3000	15	78	75	C1
ECW24-1215	18...36	12.0	1250	15	81	75	C1
ECW24-1515	18...36	15.0	1000	15	81	75	C1
ECW48-0315	36...72	3.3	3000	10	76	75	C1
ECW48-0515	36...72	5.1	3000	10	80	75	C1
ECW48-1215	36...72	12.0	1250	15	82	75	C1
ECW48-1515	36...72	15.0	1000	15	82	75	C1
Dual Output							
	VDC	VDC	mA	mA	%	mV _{pp}	
ECW12-050515	9...18	± 5.1	± 1500	35	77	75	C2
ECW12-121215	9...18	± 12.0	± 625	35	77	75	C2
ECW12-151515	9...18	± 15.0	± 500	35	77	75	C2
ECW24-050515	18...36	± 5.1	± 1500	25	80	75	C2
ECW24-121215	18...36	± 12.0	± 625	25	80	75	C2
ECW24-151515	18...36	± 15.0	± 500	25	80	75	C2
ECW48-050515	36...72	± 5.1	± 1500	20	81	75	C2
ECW48-121215	36...72	± 12.0	± 625	20	81	75	C2
ECW48-151515	36...72	± 15.0	± 500	20	81	75	C2
Option:	ECW...15BT	T = remote on/off				Pinning see data sheet	
	ECW...15BA	A = ext. output voltage adjustment $\pm 10\%$, only for single output				Pinning see data sheet	

15 Watt**OCW-Series, 1x1"****2:1 input voltage range open frame DC/DC converter line**

- High efficiency up to 89 %
- Very low profile
- I/O isolation of 2'250 VDC
- Continuous short circuit proof
- Over temperature protection
- Remote on/off control
- External output voltage adjustment $\pm 10\%$
- Low output ripple and noise
- Pi-filter at input
- Suffix -N for negative remote on/off logic
- **Dimensions (L x W x H): 27.9 x 24.4 x 9.2 mm**

Model	U _{in}	U _{out}	I _{out}	No load	η typ.	Ripple	Pinning
Single Output	VDC	VDC	A	mA	%	mVpp	
OCW24-0315SB	18...36	3.3	4.00	30	84	100	SB1
OCW24-0515SB	18...36	5.0	3.00	30	85	100	SB1
OCW24-1215SB	18...36	12.0	1.25	40	87	100	SB1
OCW24-1515SB	18...36	15.0	1.00	40	87	100	SB1
OCW48-0315SB	36...72	3.3	4.00	30	86	75	SB1
OCW48-0515SB	36...72	5.0	3.00	30	87	75	SB1
OCW48-1215SB	36...72	12.0	1.25	40	89	75	SB1
OCW48-1515SB	36...72	15.0	1.00	40	89	75	SB1

Optional: OCW...-...SBN N = negative remote on/off logic Pinning SB1

15 Watt**OCW-Series, 1x1" SMD****2:1 input voltage range open frame DC/DC converter line**

- High efficiency up to 89 %
- Very low profile
- I/O isolation of 2'250 VDC
- Continuous short circuit proof
- Over temperature protection
- Remote on/off control
- External output voltage adjustment $\pm 10\%$
- Low output ripple and noise
- Pi-filter at input
- **Dimensions (L x W x H): 27.9 x 24.4 x 9.2 mm**



Model	U _{in}	U _{out}	I _{out}	No load	η typ.	Ripple	Pinning
Single Output	VDC	VDC	A	mA	%	mVpp	
OCW24-0315SB-S	18...36	3.3	4.00	30	84	100	SBS1
OCW24-0515SB-S	18...36	5.0	3.00	30	85	100	SBS1
OCW24-1215SB-S	18...36	12.0	1.25	40	87	100	SBS1
OCW24-1515SB-S	18...36	15.0	1.00	40	87	100	SBS1
OCW48-0315SB-S	36...72	3.3	4.00	30	86	75	SBS1
OCW48-0515SB-S	36...72	5.0	3.00	30	87	75	SBS1
OCW48-1215SB-S	36...72	12.0	1.25	40	89	75	SBS1
OCW48-1515SB-S	36...72	15.0	1.00	40	89	75	SBS1

Optional: OCW...-...SBN N = negative remote on/off logic Pinning SBS1

15 Watt**OCW-Series, 2x1"****2:1 input voltage range open frame DC/DC converter line**

- I/O isolation of 1'500 VDC
- Continuous short circuit proof
- High efficiency up to 87 %
- Over temperature protection
- Remote on/off control
- External output voltage adjustment $\pm 10\%$
- Low output ripple and noise
- Pi-filter at input
- **Dimensions (L x W x H): 50.8 x 25.4 x 10.2 mm**

Model	Uin	Uout	Iout	No load	η typ.	Ripple	Pinning
Single Output	VDC	VDC	A	mA	%	mVpp	
OCW24-0515	18...36	5.0	3.0	40	87	75	B4
OCW24-1V815	18...36	1.8	6.0	30	83	75	B4
OCW24-2V515	18...36	2.5	6.0	30	85	75	B4
OCW24-3V315	18...36	3.3	4.5	30	86	75	B4
OCW48-0515	36...72	5.0	3.0	40	87	75	B4
OCW48-1V815	36...72	1.8	6.0	30	83	75	B4
OCW48-2V515	36...72	2.5	6.0	30	86	75	B4
OCW48-3V315	36...72	3.3	4.5	30	87	75	B4

15 Watt**UCU-Series, 2x2"****4:1 input voltage range DC/DC converter line with up to 3 outputs**

- I/O isolation of 500 VDC
- Continuous short circuit proof
- High efficiency
- Remote on/off control
- External output voltage adjustment $\pm 10\%$
- No derating up to 71 °C
- Low output ripple and noise
- Pi-filter at input
- Low silhouette
- Metal case with non conductive base plate, six sides shielded
- UL and cUL1950 certified
- **Dimensions (L x W x H): 50.8 x 50.8 x 10.2 mm**



Model	Uin	Uout	Iout	No load	η typ.	Ripple	Pinning
Single Output	VDC	VDC	mA	mA	%	mVpp	
UCU24-0315	9...36	3.3	3000	15	76	75	C5
UCU24-0515	9...36	5.1	3000	15	77	75	C5
UCU24-1215	9...36	12.0	1250	15	80	75	C5
UCU24-1515	9...36	15.0	1000	15	80	75	C5
UCU48-0315	18...72	3.3	3000	10	76	75	C5
UCU48-0515	18...72	5.1	3000	10	77	75	C5
UCU48-1215	18...72	12.0	1250	10	80	75	C5
UCU48-1515	18...72	15.0	1000	10	80	75	C5
Dual Output	VDC	VDC	mA	mA	%	mVpp	
UCU24-050515	9...36	± 5.1	± 1500	20	77	75	C6
UCU24-121215	9...36	± 12.0	± 625	20	80	75	C6
UCU24-151515	9...36	± 15.0	± 500	20	80	75	C6
UCU48-050515	18...72	± 5.1	± 1500	15	79	75	C6
UCU48-121215	18...72	± 12.0	± 625	15	82	75	C6
UCU48-151515	18...72	± 15.0	± 500	15	82	75	C6
Triple Output	VDC	VDC	mA	mA	%	mVpp	
UCU24-512T15	9...36	5.1/ ± 12.0	1500/ ± 310	20	80	75	C7
UCU24-515T15	9...36	5.1/ ± 15.0	1500/ ± 250	20	80	75	C7
UCU48-512T15	18...72	5.1/ ± 12.0	1500/ ± 310	15	82	75	C7
UCU48-515T15	18...72	5.1/ ± 15.0	1500/ ± 250	15	82	75	C7

15 Watt**UCW-Series, 2x1"****2:1 input voltage range DC/DC converter line with single or dual output**

- I/O isolation of 500 VDC
- Continuous short circuit proof
- High efficiency
- No derating up to 71 °C
- Remote on/off control optional (suffix -T)
- External output voltage adjustment $\pm 10\%$ optional (suffix -A)
- Pi-filter at input
- Metal case with non conductive base plate, six sides shielded
- UL and cUL 1950 certified
- **Dimensions (L x W x H):**
50.8 x 25.4 x 10.2 mm



Model	U _{in}	U _{out}	I _{out}	No load	η typ.	Ripple	Pinning
Single Output	VDC	VDC	mA	mA	%	mV _{pp}	
UCW12-0315B	9...18	3.3	3000	20	76	75	B1
UCW12-0515B	9...18	5.1	3000	20	78	75	B1
UCW12-1215B	9...18	12.0	1250	20	82	75	B1
UCW12-1515B	9...18	15.0	1000	20	82	75	B1
UCW24-0315B	18...36	3.3	3000	20	76	75	B1
UCW24-0515B	18...36	5.1	3000	20	78	100	B1
UCW24-1215B	18...36	12.0	1250	20	82	75	B1
UCW24-1515B	18...36	15.0	1000	20	82	75	B1
UCW48-0315B	36...72	3.3	3000	15	76	75	B1
UCW48-0515B	36...72	5.1	3000	10	80	100	B1
UCW48-1215B	36...72	12.0	1250	10	82	100	B1
UCW48-1515B	36...72	15.0	1000	15	83	75	B1
Dual Output	VDC	VDC	mA	mA	%	mV _{pp}	
UCW12-050515B	9...18	± 5.1	± 1500	20	78	75	B2
UCW12-121215B	9...18	± 12.0	± 625	30	83	75	B2
UCW12-151515B	9...18	± 15.0	± 500	30	83	75	B2
UCW24-050515B	18...36	± 5.1	± 1500	25	81	75	B2
UCW24-121215B	18...36	± 12.0	± 625	25	83	75	B2
UCW24-151515B	18...36	± 15.0	± 500	25	83	75	B2
UCW48-050515B	36...72	± 5.1	± 1500	20	82	75	B2
UCW48-121215B	36...72	± 12.0	± 625	20	83	75	B2
UCW48-151515B	36...72	± 15.0	± 500	20	83	75	B2
Option:	UCW...-15BT	T = remote on/off				Pinning see data sheet	
	UCW...-15BA	A = ext. output voltage adjustment $\pm 10\%$, only for single output				Pinning see data sheet	

20 Watt**ECU-Series****4:1 input voltage range DC/DC converter**

- I/O isolation of 1'500 VDC
- Continuous short circuit proof
- High efficiency
- Remote on/off control
- External output voltage adjustment $\pm 10\%$
- No derating up to 71 °C
- Low output ripple and noise
- EMC according to EN55022 Class A
- Industry standard 2x2" pinning (Size 2x1.6")
- UL and cUL certified
- Metal case with non conductive base plate, six sides shielded
- **Dimensions (L x W x H):**
50.8 x 40.6 x 11.4 mm



Model	U _{in}	U _{out}	I _{out}	No load	η typ.	Ripple	Pinning
Single Output	VDC	VDC	mA	mA	%	mV _{pp}	
ECU24-3V320	9...36	3.3	4000	15	78	75	BC1
ECU24-0520	9...36	5.1	4000	15	81	75	BC1
ECU24-1220	9...36	12.0	1670	15	83	75	BC1
ECU24-1520	9...36	15.0	1330	15	83	75	BC1
ECU48-3V320	18...72	3.3	4000	10	78	75	BC1
ECU48-0520	18...72	5.1	4000	10	82	75	BC1
ECU48-1220	18...72	12.0	1670	10	84	75	BC1
ECU48-1520	18...72	15.0	1330	10	84	75	BC1
Dual Output	VDC	VDC	mA	mA	%	mV _{pp}	
ECU24-050520	9...36	± 5.1	± 2000	20	83	75	BC2
ECU24-121220	9...36	± 12.0	± 833	20	83	75	BC2
ECU24-151520	9...36	± 15.0	± 666	20	83	75	BC2
ECU48-050520	18...72	± 5.1	± 2000	15	84	75	BC2
ECU48-121220	18...72	± 12.0	± 833	15	84	75	BC2
ECU48-151520	18...72	± 15.0	± 666	15	84	75	BC2

20 Watt

ECU 'B'-Series



4:1 input voltage range DC/DC converter line with single output

- I/O isolation of 1'500 VDC
- Continuous short circuit proof
- High efficiency
- Remote on/off control
- External output voltage adjustment $\pm 10\%$
- Low output ripple and noise
- Metal case with non conductive base plate, six sides shielded
- **Dimensions (L x W x H): 50.8 x 25.4 x 10.2 mm**

20 Watt

ECW-Series



2:1 input voltage range DC/DC converter line with single or dual output

- I/O isolation of 1'500 VDC
- Continuous short circuit proof
- Efficiency up to 86 %
- Remote on/off control
- External output voltage adjustment $\pm 10\%$
- Low output ripple and noise
- Metal case with non conductive base plate, six sides shielded
- Operating ambient temperature -25 to +71 °C
- **Dimensions (L x W x H): 50.8 x 25.4 x 10.2 mm**



Model	U _{in}	U _{out}	I _{out}	No load	η typ.	Ripple	Pinning
Single Output	VDC	VDC	mA	mA	%	mVpp	
ECU24-3V320B-CP	9...36	3.3	5500	55	87	75	B4
ECU24-0520B-CP	9...36	5.0	4000	55	90	75	B4
ECU24-1220B-CP	9...36	12.0	1670	55	90	75	B4
ECU24-1520B-CP	9...36	15.0	1330	55	90	75	B4
ECU48-3V320B-CP	18...72	3.3	5500	25	88	75	B4
ECU48-0520B-CP	18...72	5.0	4000	25	90	75	B4
ECU48-1220B-CP	18...72	12.0	1670	25	90	75	B4
ECU48-1520B-CP	18...72	15.0	1330	25	90	75	B4
Dual Output	VDC	VDC	mA	mA	%	mVpp	
ECU24-050520B-CP	9...36	± 5.0	± 2000	55	90	75	B2
ECU24-121220B-CP	9...36	± 12.0	± 835	35	88	75	B2
ECU48-050520B-CP	18...72	± 5.0	± 2000	35	90	75	B2
ECU48-121220B-CP	18...72	± 12.0	± 835	25	90	75	B2
ECU48-151520B-CP	18...72	± 15.0	± 666	25	88	75	B2

Alternate pin configuration add suffix -EP instead of -CP (Pinning B3)

Model	U _{in}	U _{out}	I _{out}	No load	η typ.	Ripple	Pinning
Single Output	VDC	VDC	mA	mA	%	mVpp	
ECW24-1V820	18...36	1.8	6000	30	86	75	B3/B4
ECW24-2V520	18...36	2.5	5000	35	81	75	B3/B4
ECW24-3V320	18...36	3.3	5000	45	83	75	B3/B4
ECW24-5V120	18...36	5.1	4000	45	85	75	B3/B4
ECW24-1220	18...36	12.0	1670	20	90	75	B3/B4
ECW24-1520	18...36	15.0	1333	20	90	75	B3/B4
ECW48-1V820	36...72	1.8	6000	30	86	75	B3/B4
ECW48-2V520	36...72	2.5	5000	35	82	75	B3/B4
ECW48-3V320	36...72	3.3	5000	35	84	75	B3/B4
ECW48-5V120	36...72	5.1	4000	25	86	75	B3/B4
ECW48-1220	36...72	12.0	1670	20	89	75	B3/B4
ECW48-1520	36...72	15.0	1330	10	88	75	B3/B4
Dual Output	VDC	VDC	mA	mA	%	mVpp	
ECW12-121220-CP	9...18	± 12.0	± 835	40	90	75	B2
ECW12-151520-CP	9...18	± 15.0	± 670	40	90	75	B2
ECW24-121220-CP	18...36	± 12.0	± 835	20	90	75	B2
ECW24-151520-CP	18...36	± 15.0	± 670	20	90	75	B2
ECW48-121220-CP	36...72	± 12.0	± 835	10	89	75	B2
ECW48-151520-CP	36...72	± 15.0	± 670	10	89	75	B2

Alternate pin configuration add suffix -EP

Dual output only CP-version

25 Watt**ECW-Series, 2x1.6"****2:1 input voltage range DC/DC converter line single and dual output**

- Very high efficiency up to 91 %
- I/O isolation of 1'500 VDC
- Continuous short circuit proof
- No derating up to 71 °C
- Remote on/off control
- External output voltage adjustment $\pm 10\%$
- Pi-filter at input
- Metal case with non conductive base plate
- **Dimensions (L x W x H): 50.8 x 40.6 x 11.4 mm**

Model	U _{in}	U _{out}	I _{out}	No load	η typ.	Ripple	Pinning
Single Output	VDC	VDC	A	mA	%	mVpp	
ECW12-1V825SC	9...18	1.8	8.0	95	85	75	BC1
ECW12-2V525SC	9...18	2.5	8.0	95	88	75	BC1
ECW12-3V35SC	9...18	3.3	6.0	100	88	75	BC1
ECW12-5V025SC	9...18	5.0	5.0	105	89	75	BC1
ECW12-1225SC	9...18	12.0	2.0	60	87	100	BC1
ECW12-1525SC	9...18	15.0	1.6	85	86	100	BC1
ECW24-1V825SC	18...36	1.8	8.0	70	84	75	BC1
ECW24-2V525SC	18...36	2.5	8.0	70	88	75	BC1
ECW24-3V325SC	18...36	3.3	6.0	70	89	75	BC1
ECW24-0525SC	18...36	5.0	5.0	70	90	75	BC1
ECW24-1225SC	18...36	12.0	2.0	50	87	100	BC1
ECW24-1525SC	18...36	15.0	1.6	50	86	100	BC1
ECW48-1V825SC	36...72	1.8	8.0	50	84	75	BC1
ECW48-2V525SC	36...72	2.5	8.0	50	88	75	BC1
ECW48-3V325SC	36...72	3.3	6.0	50	89	75	BC1
ECW48-0525SC	36...72	5.0	5.0	50	90	75	BC1
ECW48-1225SC	36...72	12.0	2.0	30	87	100	BC1
ECW48-1525SC	36...72	15.0	1.6	30	86	100	BC1

Alternative: ECW.....SCN N = negative remote on/off logic

25 Watt**OCW-Series****2:1 input voltage range open frame DC/DC converter line**

- I/O isolation of 1'500 VDC
- Continuous short circuit proof
- High efficiency up to 91 %
- Industry Standard 2x2" pinout
- Over temperature protection
- Remote on/off control
- External output voltage adjustment $\pm 10\%$
- No derating up to 60 °C
- Low output ripple and noise
- **Dimensions (L x W x H): 49.5 x 39.4 x 10.2 mm**

Model	U _{in}	U _{out}	I _{out}	No load	η typ.	Ripple	Pinning
Single Output	VDC	VDC	A	mA	%	mVpp	
OCW12-1V825	9...18	1.8	8.0	95	80	75	BC1
OCW12-2V525	9...18	2.5	8.0	95	88	75	BC1
OCW12-3V325	9...18	3.3	6.0	100	88	75	BC1
OCW12-0525	9...18	5.0	5.0	105	89	75	BC1
OCW12-1225	9...18	12.0	2.0	60	87	100	BC1
OCW12-1525	9...18	15.0	1.6	85	86	100	BC1
OCW48-1V825	36...72	1.8	8.0	30	84	75	BC1
OCW48-2V525	36...72	2.5	8.0	30	88	75	BC1
OCW48-3V325	36...72	3.3	6.0	30	89	75	BC1
OCW48-0525	36...72	5.0	5.0	30	90	75	BC1
OCW48-1225	36...72	12.0	2.0	30	87	100	BC1
OCW48-1525	36...72	15.0	1.6	30	86	100	BC1
OCW24-1V825	18...36	1.8	8.0	50	84	75	BC1
OCW24-2V525	18...36	2.5	8.0	50	88	75	BC1
OCW24-3V325	18...36	3.3	6.0	50	89	75	BC1
OCW24-0525	18...36	5.0	5.0	50	90	75	BC1
OCW24-1225	18...36	12.0	2.0	50	87	100	BC1
OCW24-1525	18...36	15.0	1.6	50	86	100	BC1

Alternative: OCW.....N N = negative remote on/off logic

30 Watt**ECU-Series****4:1 input voltage range DC/DC converter line**

- I/O isolation of 1'500 VDC
- 24 and 48 VDC 4:1 Input range
- Single and dual – version available
- Efficiency up to 91 %
- Remote on/off control
- Regulated outputs
- Input under-voltage protection
- Fixed switching frequency
- Over current protection
- Continuous short circuit protection
- 2x1 six-sided shielded metal case
- **Dimensions (L x W x H): 50.8 x 25.4 x 10.2 mm**

Model	U _{in}	U _{out}	I _{out}	No load	η typ.	Ripple	Pinning
Single Output	VDC	VDC	mA	mA	%	mVpp	
ECU24-0530	9...36	5.0	6000	100	90.0	100	B3
ECU24-1230	9...36	12.0	2500	35	91.0	100	B3
ECU24-1530	9...36	15.0	2000	35	90.5	100	B3
ECU24-3V330	9...36	3.3	7500	100	89.0	100	B3
ECU48-0530	18...72	5.0	6000	55	90.0	100	B3
ECU48-1230	18...72	12.0	2500	25	90.0	100	B3
ECU48-1530	18...72	15.0	2000	20	90.5	100	B3
ECU48-3V330	18...72	3.3	7500	55	88.0	100	B3
Dual Output	VDC	VDC	mA	mA	%	mVpp	
ECU24-121230	9...36	±12.0	±1250	35	90.0	100	B3
ECU24-151530	9...36	±15.0	±1000	35	90.0	100	B3
ECU48-121230	18...72	±12.0	±1250	25	90.5	100	B3
ECU48-151530	18...72	±15.0	±1000	20	90.0	100	B3
Alternative:	ECU...N				N = negative remote on/off logic		

25-30 Watt**ECW-Series****4:1 input voltage range DC/DC converter line with up to 3 output voltages**

- I/O isolation of 500 VDC
- Continuous short circuit proof
- Remote on/off control
- External output voltage adjustment ± 10 %
- Low output ripple and noise
- No derating up to 71 °C
- Metal case with non conductive base plate, six sides shielded
- Operating ambient temperature -25 to +71 °C
- **Dimensions (L x W x H): 76.2 x 65 x 21 mm**

Model	U _{in}	U _{out}	I _{out}	No load	η typ.	Ripple	Pinning
Single Output	VDC	VDC	mA	mA	%	mVpp	
ECW24-0525	9...36	5.0	5000	20	77	75	E1
ECW24-1230	9...36	12.0	2500	20	81	75	E1
ECW24-1530	9...36	15.0	2000	20	81	75	E1
ECW48-0525	18...72	5.0	5000	15	78	75	E1
ECW48-1230	18...72	12.0	2500	15	81	75	E1
ECW48-1530	18...72	15.0	2000	15	81	75	E1
Dual Output	VDC	VDC	mA	mA	%	mVpp	
ECW24-121230	9...36	±12.0	±1250	25	84	75	E2
ECW24-151530	9...36	±15.0	±1000	20	84	75	E2
ECW48-121230	18...72	±12.0	±1250	20	84	75	E2
ECW48-151530	18...72	±15.0	±1000	20	84	75	E2
Triple Output	VDC	VDC	mA	mA	%	mVpp	
ECW24-512T30	9...36	5.0/±12.0	3000/±625	25	79	75	E3
ECW24-515T30	9...36	5.0/±15.0	3000/±500	25	80	75	E3
ECW48-512T30	18...72	5.0/±12.0	3000/±625	20	79	75	E3
ECW48-515T30	18...72	5.0/±15.0	3000/±500	20	80	75	E3

25-30 Watt

ECW 'C'-Series

2:1 input voltage range DC/DC converter line with up to 3 output voltages in a 2x2" case

- I/O isolation of 500 VDC
- Continuous short circuit proof
- Efficiency up to 85 %
- Remote on/off control
- External output voltage adjustment $\pm 10\%$
- Low output ripple and noise
- No derating up to 71 °C
- Metal case with non conductive base plate, six sides shielded
- Operating ambient temperature - 25 to + 71 °C
- **Dimensions (L x W x H): 50.8 x 50.8 x 10.2 mm**

Model	U _{in}	U _{out}	I _{out}	No load	η typ.	Ripple	Pinning
Single Output	VDC	VDC	mA	mA	%	mVpp	
ECW12-0325C	9...18	3.3	5000	30	74	75	C5
ECW12-0525C	9...18	5.1	5000	30	78	75	C5
ECW12-1230C	9...18	12.0	2500	30	82	75	C5
ECW12-1530C	9...18	15.0	2000	30	82	75	C5
ECW24-0325C	18...36	3.3	5000	30	75	75	C5
ECW24-0525C	18...36	5.1	5000	30	79	75	C5
ECW24-1230C	18...36	12.0	2500	30	82	75	C5
ECW24-1530C	18...36	15.0	2000	30	82	75	C5
ECW48-0325C	36...72	3.3	5000	20	75	75	C5
ECW48-0525C	36...72	5.1	5000	20	79	75	C5
ECW48-1230C	36...72	12.0	2500	20	82	75	C5
ECW48-1530C	36...72	15.0	2000	20	82	75	C5
Dual Output	VDC	VDC	mA	mA	%	mVpp	
ECW12-050525C	9...18	± 5.1	± 2500	35	78	75	C6
ECW12-121230C	9...18	± 12.0	± 1250	35	82	75	C6
ECW12-151530C	9...18	± 15.0	± 1000	35	82	75	C6
ECW24-050525C	18...36	± 5.1	± 2500	30	79	75	C6
ECW24-121230C	18...36	± 12.0	± 1250	30	85	75	C6
ECW24-151530C	18...36	± 15.0	± 1000	30	85	75	C6
ECW48-050525C	36...72	± 5.1	± 2500	25	79	75	C6
ECW48-121230C	36...72	± 12.0	± 1250	25	85	75	C6
ECW48-151530C	36...72	± 15.0	± 1000	25	85	75	C6
Triple Output	VDC	VDC	mA	mA	%	mVpp	
ECW12-512T25C	9...18	5.1/ ± 12.0	3500/ ± 310	35	79	75	C7
ECW12-515T25C	9...18	5.1/ ± 15.0	3500/ ± 250	35	79	75	C7
ECW24-512T25C	18...36	5.1/ ± 12.0	3500/ ± 310	30	80	75	C7
ECW24-515T25C	18...36	5.1/ ± 15.0	3500/ ± 250	30	80	75	C7
ECW48-512T25C	36...72	5.1/ ± 12.0	3500/ ± 310	25	80	75	C7
ECW48-515T25C	36...72	5.1/ ± 15.0	3500/ ± 250	25	80	75	C7

30 Watt

ECW 'B'-Series

2:1 input voltage range DC/DC converter line in a 2x1" case

- 2:1 input voltage range
- Industry standard pinning
- I/O isolation of 1'500 VDC
- Continuous short circuit proof
- Remote on/off control
- External output voltage adjustment $\pm 10\%$
- **Dimensions (L x W x H): 50.8 x 25.4 x 10.2 mm**

Model	U _{in}	U _{out}	I _{out}	No load	η typ.	Ripple	Pinning
Single Output	VDC	VDC	mA	mA	%	mVpp	
ECW12-3V330B	9...18	3.3	7500	170	86.0	75	B3
ECW12-0530B	9...18	5.0	6000	140	87.0	75	B3
ECW12-1230B	9...18	12.0	2500	50	90.0	100	B3
ECW12-1530B	9...18	15.0	2000	50	90.0	100	B3
ECW24-0530B	18...36	5.0	6000	90	89.0	75	B3
ECW24-1230B	18...36	12.0	2500	50	92.0	100	B3
ECW24-1530B	18...36	15.0	2000	60	92.0	100	B3
ECW24-3V330B	18...36	3.3	7500	110	87.0	100	B3
ECW48-0530B	36...72	5.0	6000	50	88.0	75	B3
ECW48-1230B	36...72	12.0	2500	30	91.0	100	B3
ECW48-1530B	36...72	15.0	2000	30	91.0	100	B3
ECW48-3V330B	36...72	3.3	7500	60	87.5	100	B3
Dual Output	VDC	VDC	mA	mA	%	mVpp	
ECW12-121230B	9...18	± 12.0	± 1250	50	89.5	100	B3
ECW12-151530B	9...18	± 15.0	± 1000	50	90.0	100	B3
ECW12-151530B	9...18	± 15.0	± 1000	50	90.0	100	B3
ECW24-121230B	18...36	± 12.0	± 1250	30	90.5	100	B3
ECW24-151530B	18...36	± 15.0	± 1000	30	90.5	100	B3
ECW48-121230B	36...72	± 12.0	± 1250	30	89.5	100	B3
ECW48-151530B	36...72	± 15.0	± 1000	30	90.5	100	B3

Alternative:

ECW...40CN

N = negative remote on/off logic

25-30 Watt

UCW 'C'-Series

2:1 input voltage range DC/DC converter line with up to 3 output voltages in a 2x2" case

- I/O isolation of 500 VDC
- Continuous short circuit proof
- Efficiency up to 85 %
- Remote on/off control
- External output voltage adjustment $\pm 10\%$
- Low output ripple and noise
- No derating up to 71 °C
- Metal case with non conductive base plate, six sides shielded
- Operating ambient temperature - 25 to +71 °C
- UL and cUL 1950 certified
- **Dimensions (L x W x H):**
50.8 x 50.8 x 10.2 mm



Model	U _{in}	U _{out}	I _{out}	No load	η typ.	Ripple	Pinning
Single Output	VDC	VDC	mA	mA	%	mVpp	
UCW12-0325C	9...18	3.3	5000	30	74	75	C5
UCW12-0525C	9...18	5.1	5000	30	78	75	C5
UCW12-1230C	9...18	12.0	2500	30	82	75	C5
UCW12-1530C	9...18	15.0	2000	30	82	75	C5
UCW24-0325C	18...36	3.3	5000	30	75	75	C5
UCW24-0525C	18...36	5.1	5000	30	79	75	C5
UCW24-1230C	18...36	12.0	2500	30	82	75	C5
UCW24-1530C	18...36	15.0	2000	30	82	75	C5
UCW48-0325C	36...72	3.3	5000	20	75	75	C5
UCW48-0525C	36...72	5.1	5000	20	79	75	C5
UCW48-1230C	36...72	12.0	2500	20	82	75	C5
UCW48-1530C	36...72	15.0	2000	20	82	75	C5
Dual Output	VDC	VDC	mA	mA	%	mVpp	
UCW12-050525C	9...18	± 5.1	± 2500	35	78	75	C6
UCW12-121230C	9...18	± 12.0	± 1250	35	82	75	C6
UCW12-151530C	9...18	± 15.0	± 1000	35	82	75	C6
UCW24-050525C	18...36	± 5.1	± 2500	30	79	75	C6
UCW24-121230C	18...36	± 12.0	± 1250	30	85	75	C6
UCW24-151530C	18...36	± 15.0	± 1000	30	85	75	C6
UCW48-050525C	36...72	± 5.1	± 2500	25	79	75	C6
UCW48-121230C	36...72	± 12.0	± 1250	25	85	75	C6
UCW48-151530C	36...72	± 15.0	± 1000	25	85	75	C6
Triple Output	VDC	VDC	mA	mA	%	mVpp	
UCW12-512T25C	9...18	5.1/ ± 12.0	3500/ ± 310	35	79	75	C7
UCW12-515T25C	9...18	5.1/ ± 15.0	3500/ ± 250	35	79	75	C7
UCW24-512T25C	18...36	5.1/ ± 12.0	3500/ ± 310	30	80	75	C7
UCW24-515T25C	18...36	5.1/ ± 15.0	3500/ ± 250	30	80	75	C7
UCW48-512T25C	36...72	5.1/ ± 12.0	3500/ ± 310	25	80	75	C7
UCW48-515T25C	36...72	5.1/ ± 15.0	3500/ ± 250	25	80	75	C7

40 Watt

ECW 'C'-Series

2:1 input voltage range DC/DC converter line with single voltage in a 2x2" case

- High efficiency up to 90 %
- I/O isolation of 500 VDC
- Continuous short circuit proof
- External output voltage trim $\pm 10\%$
- Remote on/off control
- Over temperature protection
- No derating up to 60 °C
- External output voltage adjustment $\pm 10\%$
- Metal case with non conductive base plate
- Sense function + 10 %
- UL and cUL 60950 certified
- **Dimensions (L x W x H):**
50.8 x 50.8 x 10.2 mm



Model	U _{in}	U _{out}	I _{out}	No load	η typ.	Ripple	Pinning
Single Output							
	VDC	VDC	A	mA	%	mVpp	
ECW12-2V540C	9...18	2.5	10.0	200	88	50	C8
ECW12-0340C	9...18	3.3	10.0	200	89	50	C8
ECW12-0540C	9...18	5.0	8.0	200	89	50	C8
ECW12-1240C	9...18	12.0	3.33	200	90	50	C8
ECW12-1540C	9...18	15.0	2.66	200	90	50	C8
ECW24-2V540C	18...72	2.5	10.0	100	88	50	C8
ECW24-0340C	18...36	3.3	8.0	100	87	50	C8
ECW24-0540C	18...36	5.0	8.0	100	89	50	C8
ECW24-1240C	18...36	12.0	3.33	100	88	75	C8
ECW24-1540C	18...36	15.0	2.67	100	89	75	C8
ECW48-2V540	36...72	2.5	10.0	50	89	50	C8
ECW48-0340C	36...72	3.3	8.0	100	88	50	C8
ECW48-0540C	36...72	5.0	8.0	100	90	50	C8
ECW48-1240C	36...72	12.0	3.33	100	89	75	C8
ECW48-1540C	36...72	15.0	2.67	100	89	75	C8
Dual Output							
	VDC	VDC	A	mA	%	mVpp	
ECW12-121240C	9...18	± 12.0	± 1.8	100	89	75	C9
ECW12-151540C	9...18	± 15.0	± 1.4	100	90	75	C9
ECW24-121240C	18...36	± 12.0	± 1.8	100	91	75	C9
ECW24-151540C	18...36	± 15.0	± 1.4	100	92	75	C9
ECW48-121240C	36...72	± 12.0	± 1.8	50	90	75	C9
ECW48-151540C	36...72	± 15.0	± 1.4	50	91	75	C9
ECW12-3V3D0540C	9...18	3.3/ ± 5.0	10.0/+7.5	100	89	100	C11
ECW24-3V3D0540C	18...36	3.3/ ± 5.0	10.0/+7.5	50	90	100	C11
ECW48-3V3D0540C	36...72	3.3/ ± 5.0	10.0/+7.5	50	90	100	C11
Triple Output							
	VDC	VDC	A	mA	%	mVpp	
ECW12-312T40C	9...18	3.3/ ± 12.0	6.0/+0.4	200	88	75	C10
ECW12-315T40C	9...18	3.3/ ± 15.0	6.0/+0.3	200	88	75	C10
ECW12-512T40C	9...18	5.0/ ± 12.0	6.0/+0.4	200	88	75	C10
ECW12-515T40C	9...18	5.0/ ± 15.0	6.0/+0.3	200	90	75	C10
ECW24-312T40C	18...36	3.3/ ± 12.0	6.0/+0.4	100	90	75	C10
ECW24-315T40C	18...36	3.3/ ± 15.0	6.0/+0.3	100	90	75	C10
ECW24-512T40C	18...36	5.0/ ± 12.0	6.0/+0.4	100	90	75	C10
ECW24-515T40C	18...36	5.0/ ± 15.0	6.0/+0.3	100	90	75	C10
ECW48-312T40C	36...72	3.3/ ± 12.0	6.0/+0.4	50	89	75	C10
ECW48-315T40C	36...72	3.3/ ± 15.0	6.0/+0.3	50	87	75	C10
ECW48-512T40C	36...72	5.0/ ± 12.0	6.0/+0.4	50	88	75	C10
ECW48-515T40C	36...72	5.0/ ± 15.0	6.0/+0.3	50	90	75	C10

Alternative:

ECW...-40CN

N = negative remote on/off logic

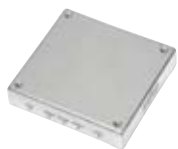
50 Watt**ECU-Series****4:1 input voltage range DC/DC converter line**

- 4:1 input voltage range
- Industry standard pinning
- I/O isolation of 1'500 VDC
- Continuous short circuit proof
- Over temperature protection
- Remote on/off control
- Sense
- External output voltage adjustment $\pm 10\%$
- UL and cUL certified
- Metal case with non conductive base plate, five sides shielded
- Ready for mounting on heat sink

• **Dimensions (L x W x H):**
61 x 58 x 12.7 mm



Model	U _{in}	U _{out}	I _{out}	No load	η typ.	Ripple	Pinning
Single Output	VDC	VDC	A	mA	%	mVpp	
ECU24-3V350	9...36	3.3	10.00	50	77	100	HB1
ECU24-5V050	9...36	5.0	10.00	50	81	100	HB1
ECU24-1250	9...36	12.0	4.16	50	83	150	HB1
ECU24-1550	9...36	15.0	3.33	50	83	150	HB1
ECU24-2450	9...36	24.0	2.08	50	83	240	HB1
ECU48-3V350	18...72	3.3	10.00	50	78	100	HB1
ECU48-5V050	18...72	5.0	10.00	50	82	100	HB1
ECU48-1250	18...72	12.0	4.16	50	84	150	HB1
ECU48-1550	18...72	15.0	3.33	50	84	150	HB1
ECU48-2450	18...72	24.0	2.08	50	84	240	HB1

Alternative:

ECU...N

N = negative remote on/off logic

50 Watt**ECW-Series****2:1 input voltage range DC/DC converter line**

- Industry standard pinning
- I/O isolation of 1'500 VDC
- Continuous short circuit proof
- Over temperature protection
- Efficiency up to 86 %
- Remote on/off control
- Sense
- Ext. output voltage trimming $\pm 10\%$
- Metal case with non conductive base plate, five sides shielded
- Ready for mounting on heat sink
- UL and cUL1950 certified

• **Dimensions (L x W x H):**
61 x 58 x 12.7 mm



Model	U _{in}	U _{out}	I _{out}	No load	η typ.	Ripple	Pinning
Single Output	VDC	VDC	A	mA	%	mVpp	
ECW12-2V550	9...18	2.5	10.00	50	76	75	HB1
ECW12-0350	9...18	3.3	10.00	50	78	75	HB1
ECW12-0550	9...18	5.1	10.00	50	81	75	HB1
ECW12-1250	9...18	12.0	4.16	50	84	100	HB1
ECW12-1550	9...18	15.0	3.33	50	84	100	HB1
ECW12-2450	9...18	24.0	2.08	50	84	240	HB1
ECW24-2V550	18...36	2.5	10.00	50	77	75	HB1
ECW24-0350	18...36	3.3	10.00	50	79	75	HB1
ECW24-0550	18...36	5.1	10.00	50	82	75	HB1
ECW24-1250	18...36	12.0	4.16	50	85	100	HB1
ECW24-1550	18...36	15.0	3.33	50	85	100	HB1
ECW24-2450	18...36	24.0	2.08	50	86	240	HB1
ECW48-2V550	36...72	2.5	10.00	50	77	75	HB1
ECW48-0350	36...72	3.3	10.00	50	79	75	HB1
ECW48-0550	36...72	5.1	10.00	50	82	75	HB1
ECW48-1250	36...72	12.0	4.16	50	85	100	HB1
ECW48-1550	36...72	15.0	3.33	50	85	100	HB1
ECW48-2450	36...72	24.0	2.08	50	86	240	HB1

Alternative:

ECW...50N

N = negative remote on/off logic

75 Watt**ECU-Series****4:1 input voltage range DC/DC converter line**

- 4:1 input voltage range
- Industry standard pinning
- I/O isolation of 1'500 VDC
- Continuous short circuit proof
- Over temperature protection
- Remote on/off control
- Sense
- External output voltage adjustment $\pm 10\%$
- UL and cUL certified
- Metal case with non conductive base plate, five sides shielded
- Ready for mounting on heat sink

• **Dimensions (L x W x H):**
61 x 58 x 12.7 mm



Model	U _{in}	U _{out}	I _{out}	No load	η typ.	Ripple	Pinning
Single Output	VDC	VDC	A	mA	%	mVpp	
ECU24-3V375	9...36	3.3	15.00	50	78	100	HB1
ECU24-5V075	9...36	5.0	15.00	50	82	100	HB1
ECU24-1275	9...36	12.0	6.25	50	84	150	HB1
ECU24-1575	9...36	15.0	5.00	50	84	150	HB1
ECU24-2475	9...36	24.0	3.12	50	84	240	HB1
ECU48-3V375	18...72	3.3	15.00	50	78	100	HB1
ECU48-5V075	18...72	5.0	15.00	50	82	100	HB1
ECU48-1275	18...72	12.0	6.25	50	84	150	HB1
ECU48-1575	18...72	15.0	5.00	50	84	150	HB1
ECU48-2475	18...72	24.0	3.12	50	84	150	HB1

Alternative:

ECU...75N

N = negative remote on/off logic

75 Watt**ECW-Series****2:1 input voltage range DC/DC converter line with single and dual output**

- Industry standard pinning
- I/O isolation of 1'500 VDC
- Continuous short circuit proof
- Over temperature protection
- Remote on/off control
- Sense (single output only)
- External output voltage adjustment $\pm 10\%$
- Metal case with non conductive base plate, five sides shielded, dual output with aluminium base plate and plastic case
- Ready for mounting on heat sink
- UL and cUL1950 certified

• **Dimensions (L x W x H):**
61 x 58 x 12.7 mm (single)
61 x 58 x 13.2 mm (dual)

Model	U _{in}	U _{out}	I _{out}	No load	η typ.	Ripple	Pinning
Single Output	VDC	VDC	A	mA	%	mVpp	
ECW12-2V575	9...18	2.5	15.00	50	76	75	HB1
ECW12-0375	9...18	3.3	15.00	50	78	75	HB1
ECW12-0575	9...18	5.1	15.00	50	81	75	HB1
ECW12-1275	9...18	12.0	6.25	50	84	100	HB1
ECW12-1575	9...18	15.0	5.00	50	84	100	HB1
ECW12-2475	9...18	24.0	3.13	50	84	240	HB1
ECW24-2V575	18...36	2.5	15.00	50	77	75	HB1
ECW24-0375	18...36	3.3	15.00	50	79	75	HB1
ECW24-0575	18...36	5.1	15.00	50	82	75	HB1
ECW24-1275	18...36	12.0	6.25	50	85	100	HB1
ECW24-1575	18...36	15.0	5.00	50	85	100	HB1
ECW24-2475	18...36	24.0	3.13	50	86	240	HB1
ECW48-2V575	36...72	2.5	15.00	50	77	75	HB1
ECW48-0375	36...72	3.3	15.00	50	79	75	HB1
ECW48-0575	36...72	5.1	15.00	50	83	75	HB1
ECW48-1275	36...72	12.0	6.25	50	85	100	HB1
ECW48-1575	36...72	15.0	5.00	50	85	100	HB1
ECW48-2475	36...72	24.0	3.13	50	86	240	HB1
Dual Output	VDC	VDC	A	mA	%	mVpp	
ECW24-052V575	18...36	2.5/5.1	variable	30	84	100	HB2
ECW24-053V375	18...36	2.5/5.1	variable	30	84	100	HB2
ECW48-052V575	36...72	3.3/5.1	variable	30	84	100	HB2
ECW48-053V375	36...72	3.3/5.1	variable	30	84	100	HB2

75 Watt**EQU-Series****4:1 input voltage range DC/DC converter line**

- Industry standard pinning
- I/O isolation of 1'500 VDC
- Continuous short circuit proof
- External output voltage adjustment $\pm 10\%$
- Efficiency up to 87 %
- Remote on/off control
- Sense
- Aluminium base plate with plastic case
- Ready for mounting on heat sink
- **Dimensions (L x W x H):**
57.9 x 36.8 x 12.7 mm



Model	U _{in}	U _{out}	I _{out}	No load	η typ.	Ripple	Pinning
Single Output	VDC	VDC	A	mA	%	mVpp	
EQU24-3V375	9...36	3.3	12.00	50	81	100	QB1
EQU24-0575	9...36	5.0	12.00	50	84	100	QB1
EQU24-1275	9...36	12.0	6.26	50	86	150	QB1
EQU24-1575	9...36	15.0	5.00	50	86	150	QB1
EQU24-2475	9...36	24.0	3.12	50	86	240	QB1
EQU48-3V375	18...72	3.3	12.00	50	82	100	QB1
EQU48-0575	18...72	5.0	12.00	50	85	100	QB1
EQU48-1275	18...72	12.0	6.25	50	86	150	QB1
EQU48-1575	18...72	15.0	5.00	50	87	150	QB1
EQU48-2475	18...72	24.0	3.12	50	87	240	QB1

Alternative: EQU...100N N = negative remote on/off logic

75 Watt**EQW-Series****2:1 input voltage range DC/DC converter line**

- Industry standard pinning
- I/O isolation of 1'500 VDC
- Continuous short circuit proof
- Over temperature protection
- Efficiency up to 90 %
- Remote on/off control
- Sense
- External output voltage adjustment $\pm 10\%$
- Aluminium base plate with plastic case
- Ready for mounting on heat sink
- UL and cUL1950 certified
- **Dimensions (L x W x H):**
58 x 37 x 12.7 mm



Model	U _{in}	U _{out}	I _{out}	No load	η typ.	Ripple	Pinning
Single Output	VDC	VDC	A	mA	%	mVpp	
EQW24-1V875	18...36	1.8	25	60	83	100	QB1
EQW24-2V575	18...36	2.5	25	60	85	100	QB1
EQW24-3V375	18...36	3.3	20	70	88	100	QB1
EQW24-5V175	18...36	5.1	15	80	90	100	QB1
EQW48-1V875	36...72	1.8	0.5...25	50	84	100	QB1
EQW48-2V575	36...72	2.5	0.5...25	50	86	100	QB1
EQW48-3V375	36...72	3.3	0.5...20	50	88	100	QB1
EQW48-5V175	36...72	5.1	0.5...15	80	90	100	QB1

Alternative: EQW...75N N = negative remote on/off logic

100 Watt**ECU-Series****4:1 input voltage range DC/DC converter line with single output**

- I/O isolation of 1'500 VDC
- Industry standard pinning
- Continuous short circuit proof
- Efficiency up to 88 %
- Over temperature protection
- Sense
- External output voltage adjust
- Metal case with non conductive base plate, five sides shielded
- Operating case temperature -40 °C to +100 °C
- UL and cUL 60950 certified

• **Dimensions (L x W x H):**
61 x 58 x 12.7 mm



Model	U _{in}	U _{out}	I _{out}	No load	η typ.	Ripple	Pinning
Single Output	VDC	VDC	A	mA	%	mVpp	
ECU24-3V3100	9...36	3.3	20.00	35	81.5	100	HB1
ECU24-5V0100	9...36	5.0	20.00	35	83.5	100	HB1
ECU24-12100	9...36	12.0	8.30	35	85	150	HB1
ECU24-15100	9...36	15.0	6.70	35	86.5	150	HB1
ECU24-24100	9...36	24.0	4.17	35	86	240	HB1
ECU48-3V3100	18...72	3.3	20.00	30	80.5	100	HB1
ECU48-5V0100	18...72	5.0	20.00	30	86	100	HB1
ECU48-12100	18...72	12.0	8.30	30	86.5	150	HB1
ECU48-15100	18...72	15.0	6.70	30	87.5	150	HB1
ECU48-24100	18...72	24.0	4.17	30	88	240	HB1

Alternative:

ECU...100N

N = negative remote on/off logic

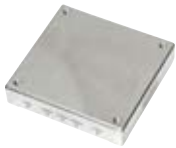
100 Watt**ECW-Series****2:1 input voltage range DC/DC converter line**

- Industry standard pinning
- I/O isolation of 1'500 VDC
- Continuous short circuit proof
- Over temperature protection
- Remote on/off control
- Sense
- External output voltage adjustment ± 10 %
- Metal case with non conductive base plate, five sides shielded
- Ready for mounting on heat sink
- UL and cUL1950 certified

• **Dimensions (L x W x H):**
61 x 58 x 12.7 mm



Model	U _{in}	U _{out}	I _{out}	No load	η typ.	Ripple	Pinning
Single Output	VDC	VDC	A	mA	%	mVpp	
ECW24-2V5100	18...36	2.5	20.00	50	77	100	HB1
ECW24-03100	18...36	3.3	20.00	50	79	100	HB1
ECW24-05100	18...36	5.1	20.00	50	83	100	HB1
ECW24-12100	18...36	12.0	8.30	50	85	150	HB1
ECW24-15100	18...36	15.0	6.70	50	85	150	HB1
ECW24-24100	18...36	24.0	4.17	50	85	240	HB1
ECW48-2V5100	36...72	2.5	20.00	50	78	100	HB1
ECW48-03100	36...72	3.3	20.00	50	80	100	HB1
ECW48-05100	36...72	5.1	20.00	50	84	100	HB1
ECW48-12100	36...72	12.0	8.30	50	85	150	HB1
ECW48-15100	36...72	15.0	6.70	50	85	150	HB1
ECW48-24100	36...72	24.0	4.17	50	85	240	HB1

Alternative:

ECW...100N

N = negative remote on/off logic

100 Watt**EQU-Series****4:1 input voltage range DC/DC converter line**

- Industry standard pinning
- I/O isolation of 1'500 VDC
- Continuous short circuit proof
- External output voltage adjustment $\pm 10\%$
- Efficiency up to 88 %
- Remote on/off control
- Sense
- Aluminium base plate with plastic case
- Ready for mounting on heat sink
- **Dimensions (L x W x H):**
57.9 x 36.8 x 12.7 mm



Model	U _{in}	U _{out}	I _{out}	No load	η typ.	Ripple	Pinning
Single Output	VDC	VDC	A	mA	%	mVpp	
EQU48-3V3100	18...72	3.3	30.00	60	88	100	QB1
EQU48-05100	18...72	5.0	20.00	60	88	100	QB1
EQU48-12100	18...72	12.0	8.30	30	88	100	QB1
EQU48-15100	18...72	15.0	6.70	30	88	100	QB1
EQU48-24100	18...72	24.0	4.17	30	88	100	QB1
Alternative:	EQU.....100N						N = negative remote on/off logic

150 Watt**ECU-Series****4:1 input voltage range DC/DC converter with single output**

- I/O isolation of 1'500 VDC
- Industry standard pinning
- Continuous short circuit proof
- Efficiency up to 90 %
- Over voltage and over temperature protection
- Low output ripple and noise
- Operating temperature -40 °C to +100 °C
- External output voltage adjust
- UL and cUL 60950 certified
- **Dimensions (L x W x H):**
61 x 57.9 x 13.2 mm

Model	U _{in}	U _{out}	I _{out}	No load	η typ.	Ripple	Pinning
Single Output	VDC	VDC	A	mA	%	mVpp	
ECU24-3V3150	9...36	3.3	30.00	100	87	100	HB1
ECU24-5V0150	9...36	5.0	30.00	100	89	100	HB1
ECU24-12150	9...36	12.0	12.50	100	90	150	HB1
ECU24-15150	9...36	15.0	10.00	100	90	150	HB1
ECU24-24150	9...36	24.0	6.50	100	89	240	HB1
ECU48-3V3150	18...72	3.3	30.00	100	87	100	HB1
ECU48-5V0150	18...72	5.0	30.00	100	89	100	HB1
ECU48-12150	18...72	12.0	12.50	50	90	150	HB1
ECU48-15150	18...72	15.0	10.00	50	90	150	HB1
ECU48-24150	18...72	24.0	6.25	50	89	240	HB1

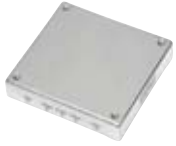
150 Watt**ECW-Series****2:1 input voltage range DC/DC converter line**

- Industry standard pinning
- I/O isolation of 1'500 VDC
- Continuous short circuit proof
- Over temperature protection
- Remote on/off control
- Sense
- External output voltage adjustment $\pm 10\%$
- Metal case with non conductive base plate, five sides shielded
- Ready for mounting on heat sink
- UL and cUL1950 certified

- **Dimensions (L x W x H):**
61 x 58 x 12.7 mm

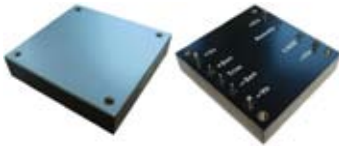

Model	U _{in}	U _{out}	I _{out}	No load	η typ.	Ripple	Pinning
Single Output	VDC	VDC	A	mA	%	mVpp	
ECW48-2V5150	36...72	2.5	30.00	25	74	100	HB1
ECW48-03150	36...72	3.3	30.00	25	79	100	HB1
ECW48-05150	36...72	5.1	30.00	25	83	100	HB1
ECW48-12150	36...72	12.0	12.50	25	85	150	HB1
ECW48-15150	36...72	15.0	8.40	25	85	150	HB1
ECW48-24150	36...72	24.0	6.25	25	85	240	HB1
Alternative:	ECW...-...150N						N = negative remote on/off logic

200 Watt**ECU-Series****4:1 input voltage range DC/DC converter with single output**

- I/O isolation of 1'500 VDC
- Industry standard pinning
- Continuous short circuit proof
- Efficiency up to 89 %
- Over voltage and over temperature protection
- Aluminium base plate with plastic case
- Operating temperature -40 °C to +100 °C
- External output voltage adjust
- Ready for mounting on heat sink

- **Dimensions (L x W x H): 61 x 57.9 x 13.2 mm**

Model	U _{in}	U _{out}	I _{out}	No load	η typ.	Ripple	Pinning
Single Output	VDC	VDC	A	mA	%	mVpp	
ECU24-12200	9...36	12.0	16.7	150	86	150	HB1
ECU24-15200	9...36	15.0	13.3	150	86	150	HB1
ECU24-24200	9...36	24.0	8.3	100	87	240	HB1
ECU24-3V3200	9...36	3.3	50.0	150	87	100	HB1
ECU24-48200	9...36	24.0	4.2	60	86	240	HB1
ECU24-5V0200	9...36	5.0	40.0	150	87	100	HB1
ECU48-12200	18...72	12.0	16.7	60	88	150	HB1
ECU48-15200	18...72	15.0	13.3	60	88	150	HB1
ECU48-24200	18...72	24.0	8.3	60	88	240	HB1
ECU48-3V3200	18...72	3.3	40.0	80	88	100	HB1
ECU48-48200	18...72	48.0	4.2	50	87	240	HB1
ECU48-5V0200	18...72	5.0	40.0	80	89	100	HB1
Alternative:	ECU...-...200N						N = negative remote on/off logic

200 Watt**ECW-Series****2:1 input voltage range DC/DC converter line**

- Industry standard pinning
- I/O isolation of 1'500 VDC
- Continuous short circuit proof
- Over temperature protection
- Remote on/off control
- Sense
- Ext. output voltage adjustment $\pm 10\%$
- Aluminium base plate with plastic case
- Ready for mounting on heat sink
- UL and cUL1950 certified

- **Dimensions (L x W x H):**
117 x 61 x 13.2 mm



Model	U _{in}	U _{out}	I _{out}	No load	η typ.	Ripple	Pinning
Single Output	VDC	VDC	A	mA	%	mVpp	
ECW48-2V5200	36...72	2.5	40.00	25	74	100	FB1
ECW48-3V3200	36...72	3.3	40.00	25	79	100	FB1
ECW48-5V1200	36...72	5.1	40.00	25	83	100	FB1
ECW48-12200	36...72	12.0	17.00	25	85	150	FB1
ECW48-15200	36...72	15.0	13.30	25	85	150	FB1
ECW48-24200	36...72	24.0	8.33	25	85	240	FB1
ECW48-28200	36...72	28.00	7.10	25	89	280	FB1
ECW48-48200	36...72	48.0	4.20	25	85	480	FB1
Alternative:	ECW...-...200N						N = negative remote on/off logic

350 Watt**ECW-Series****2:1 input voltage range DC/DC converter line**

- 231-350 W Isolated Output
- Industry standard pinning
- I/O isolation of 1'500 VDC
- Continuous short circuit proof
- Over temperature protection
- Remote on/off control
- Sense
- External output voltage adjustment $\pm 10\%$
- Aluminium base plate with plastic case
- Ready for mounting on heat sink

- **Dimensions (L x W x H):**
61 x 58 x 13.2 mm

Model	U _{in}	U _{out}	I _{out}	No load	η typ.	Ripple	Pinning
Single Output	VDC	VDC	A	mA	%	mVpp	
ECW24-05350	18...36	5.0	70.0	250	89	100	HB1
ECW24-12350	18...36	12.0	29.2	220	91	120	HB1
ECW24-24350	18...36	24.0	14.6	40	90	280	HB1
ECW24-28350	18...36	28.0	12.5	50	91	280	HB1
ECW24-3V3350	18...36	3.3	70.0	130	88	100	HB1
ECW48-05350	36...72	5.0	70.0	120	91	100	HB1
ECW48-12350	36...72	12.0	29.2	100	92	120	HB1
ECW48-24350	36...72	24.0	14.6	40	91	280	HB1
ECW48-28350	36...72	28.0	12.5	30	92	280	HB1
ECW48-3V3350	36...72	3.3	70.0	80	89	100	HB1
Alternative:	ECW...-...200N						N = negative remote on/off logic

600 Watt**ECW-Series****2:1 input voltage range DC/DC converter line**

- 600 - 700 W Isolated Output
- Industry standard pinning
- I/O isolation of 1'500 VDC
- Over voltage / current protection
- Over temperature protection
- Remote on/off control
- Sense
- External output voltage adjustment $\pm 10\%$
- Aluminium base plate with plastic case
- **Dimensions (L x W x H):**
116.8 x 61 x 12.7 mm

Model	U _{in}	U _{out}	I _{out}	No load	η typ.	Ripple	Pinning
Single Output	VDC	VDC	A	mA	%	mVpp	
ECW24-12600	18...36	12.0	50.0	150	89	120	FB
ECW24-28600	18...36	28.0	21.5	150	90	280	FB
ECW24-32600	18...36	32.0	19.0	150	91	320	FB
ECW48-12600	36...75	12.0	50.0	120	89	120	FB
ECW48-28600	18...36	28.0	25.0	105	91	280	FB
ECW48-32600	36...75	32.0	19.0	90	91	320	FB
Alternative:	ECW...-...200N		N = negative remote on/off logic				

75 Watt

VCU-Series



4:1 input voltage range DC/DC converter line for use in battery and vehicle applications

- 4:1 ultra wide input range
- 2V Hysteresis
- I/O isolation of 1'500 VDC
- Continuous short circuit proof
- Over temperature protection
- Burst and surge proof 2'000/500 VDC
- Reversed input polarity protection
- Vibration, shock and bump resistant
- EMC according to EN55022 Class B
- Aluminum chassis

- **Dimensions (L x W x H):**
163 x 83 x 28 mm



Model	Uin	Uout	Iout	No load	η typ.	Ripple	Pinning
Single Output	VDC	VDC	A	mA	%	mVpp	
VCU48-2675-A1P1-H2.C	18...72	26.4	2.84	25	84	100	S11
VCU48-2475-A1P1-H2.C	18...72	24.0	3.10	25	82	100	S11
VCU48-1375-A1P1-H2.C	18...72	13.2	5.70	25	82	100	S11
VCU24-2675-A1P1-H2.C	9...36	26.4	2.84	30	84	100	S11
VCU24-2475-A1P1-H2.C	9...36	24.0	3.10	30	82	100	S11
VCU24-1375-A1P1-H2.C	9...36	13.2	5.70	30	81	100	S11
VCU110-2675-A1P1-H2.C	66...154	26.4	2.84	15	84	100	S11
VCU110-2475-A1P1-H2.C	66...154	24.0	3.10	15	83	100	S11
VCU110-1375-A1P1-H2.C	66...154	13.2	5.70	15	83	100	S11

Vehicle UPS

UPS-Series



UPS for the VCLU vehicle converter line

- Sealed lead battery
- Temperature controlled charging
- Vibration, shock and bump resistant
- Input power fail signal (LED/PC)
- Internal battery short circuit protection
- RS232 interface
- Aluminum chassis

- **Dimensions: 190 x 55 x 131 mm**

Model	Uout nom	Uout range	Iout	Capacity	Uin nom	Connector
Single Output	VDC	VDC	A		VDC	
VUPS-1375-EV9-C	12	9...14.2	6	6Ah@1h	13.2	Screw Term.
VUPS-2675-EP5-C	24	18...28.4	3	3Ah@1h	26.4	Screw Term.

Other input and output voltages available upon request

5-6 Watt**CFM-Series****Cost-effective open frame modules with universal input range**

- 85-264 VAC universal input range
- 47-63 Hz
- 3'000 VAC input to output isolation
- EMC according to EN55022 Class B
- Through-hole pinning
- High efficiency
- UL/cUL certified
- CE certified
- **Dimensions: 55 x 35 x 21 mm**

Model	U _{in}	U _{out}	I _{out}	η typ.	Ripple
Single Output	VAC	VDC	mA	%	mVpp
CFM-05S033	85...264	3.3	1250	70-77	50
CFM-05S050	85...264	5.0	1000	70-77	50
CFM-05S090	85...264	9.0	550	70-77	90
CFM-05S120	85...264	12.0	420	70-77	120
CFM-05S150	85...264	15.0	330	70-77	150
CFM-05S180	85...264	18.0	280	70-77	180
CFM-05S240	85...264	24.0	230	70-77	240

10 Watt**CFM-Series****Cost-effective open frame modules with universal input range**

- 85 to 264 VAC universal input range
- 47-63 Hz
- 3'000 VAC input to output isolation
- EMC according to EN55022 Class B
- PCB Pinning
- High efficiency
- Industry standard pinning
- UL/cUL certified
- CE certified
- **Dimensions: 65 x 45 x 23 mm**

Model	U _{in}	U _{out}	I _{out}	η typ.	Ripple
Single Output	VAC	VDC	mA	%	mVpp
CFM-1007S	85...264	3.3	2500	65	50
CFM-1001S	85...264	5.0	2000	70	50
CFM-1009S	85...264	9.0	1120	72	90
CFM-1002S	85...264	12.0	833	75	120
CFM-1003S	85...264	15.0	667	75	150
CFM-1005S	85...264	24.0	417	78	240

15 Watt**CFM-Series****Cost-effective open frame modules with universal input range**

- 85 to 264 VAC universal input range
- 47-63 Hz
- 3'000 VAC input to output isolation
- EMC according to EN55022 Class B
- PCB Pinning
- High efficiency
- Industry standard pinning
- UL/cUL certified
- CE certified
- **Dimensions: 70 x 48 x 23 mm**

Model	U _{in}	U _{out}	I _{out}	η typ.	Ripple
Single Output	VAC	VDC	mA	%	mVpp
CFM-1501S	85...264	5.0	3000	73	50
CFM-1502S	85...264	12.0	1250	80	120
CFM-1503S	85...264	15.0	1000	80	150
CFM-1505S	85...264	24.0	630	82	240
CFM-1507S	85...264	3.3	3000	70	50
CFM-1509S	85...264	9.0	1670	75	90

20 Watt**CFM-Series****Cost-effective open frame modules with universal input range**

- 85 to 264 VAC universal input range
- 47-63 Hz
- 3'000 VAC input to output isolation
- EMC according to EN55022 Class B
- Molex connectors
- High efficiency
- UL/cUL certified
- CE certified

• **Dimensions: 89 x 51 x 20 mm**

Model	U _{in}	U _{out}	I _{out}	η typ.	Ripple
Single Output	VAC	VDC	mA	%	mVpp
CFM-2007S	85...264	3.3	4400	70	50
CFM-2001S	85...264	5.0	4400	73	50
CFM-2009S	85...264	9.0	2450	75	90
CFM-2002S	85...264	12.0	1800	80	120
CFM-2003S	85...264	15.0	1400	80	150
CFM-2005S	85...264	24.0	920	82	240

40 Watt**CFM-Series****Cost-effective open frame modules with universal input range**

- 90-264 VAC and 120-370 VDC input range
- 47-440 Hz
- 3'000 VAC input to output isolation
- EMC according to EN55022 Class B
- Molex connectors
- High efficiency
- UL/cUL certified
- CE certified

• **Dimensions: 102 x 51 x 30 mm**

Model	U _{in}	U _{out}	I _{out}	η typ.	Ripple
Single Output	VAC	VDC	mA	%	mVpp
CFM-40S033	90...264	3.3	6000	74	50
CFM-40S050	90...264	5.0	6000	76	50
CFM-40S090	90...264	9.0	4450	80	90
CFM-40S120	90...264	12.0	3340	82	120
CFM-40S150	90...264	15.0	2670	83	150
CFM-40S240	90...264	24.0	1670	85	240
CFM-40S300	90...264	30.0	1330	86	300
CFM-40S360	90...264	36.0	1110	87	360
CFM-40S480	90...264	48.0	834	87	480

40 Watt**CFM-Series, Dual****Cost-effective open frame modules with universal input range**

- 90-264 VAC and 120-370 VDC input range
- 47-440 Hz
- 3'000 VAC input to output isolation
- EMC according to EN55022 Class B
- Molex connectors
- High efficiency
- UL/cUL certified
- CE certified

• **Dimensions: 102 x 51 x 30 mm**

Model	U _{in}	U _{out}	I _{out}	η typ.	Ripple
Dual Output	VAC	VDC	A	%	mVpp
CFM-40D-01	90...264	5.0	5.0	77	50
		12.0	2.5		120
CFM-40D-02	90...264	5.0	5.0	78	50
		24.0	1.5		240

40 Watt

CFM-Series, Triple

Cost-effective open frame modules with universal input range

- 90-264 VAC and 120-370 VDC input range
- 47-440 Hz
- 3'000 VAC input to output isolation
- EMC according to EN55022 Class B
- Molex connectors
- High efficiency
- UL/cUL certified
- CE certified
- **Dimensions: 102 x 51 x 30 mm**

Model	U _{in}	U _{out}	I _{out}	η typ.	Ripple
Dual Output	VAC	VDC	mA	%	mV _{pp}
CFM-40T-07	90...264	3.3	7000	70	50
		5.0	3500		50
		-12.0	500		120
CFM-40T-01	90...264	5.0	5000	75	50
		12.0	2500		120
		-5.0	500		50
CFM-40T-02	90...264	5.0	5000	75	50
		12.0	2500		120
		-12.0	500		120
CFM-40T-03	90...264	5.0	5000	75	50
		15.0	2300		150
		-15.0	500		150
CFM-40T-04	90...264	5.0	5000	75	50
		24.0	1500		240
		-12.0	500		120
CFM-40T-05	90...264	5.0	5000	75	50
		24.0	1500		240
		-5.0	500		50
CFM-40T-06	90...264	5.0	5000	75	50
		24.0	1500		240
		12.0	500		120

60 Watt

CFM-Series

Cost-effective open frame modules with universal input range

- 85 to 264 VAC universal input range
- 47-63 Hz
- 3'000 VAC input to output isolation
- EMC according to EN55022 Class B
- Molex connectors
- High efficiency
- UL/cUL certified
- CE certified
- **Dimensions: 102 x 51 x 30 mm**
- **Triple: 102 x 51 x 32 mm**

Model	U _{in}	U _{out}	I _{out}	η typ.	Ripple
Single Output	VAC	VDC	mA	%	mV _{pp}
CFM-60C240	90...264	24.0	2500	85	240
CFM-60S033	90...264	3.3	8000	74	50
CFM-60S050	90...264	5.0	8000	76	50
CFM-60S090	90...264	9.0	6670	80	90
CFM-60S120	90...264	12.0	5000	82	120
CFM-60S150	90...264	15.0	4000	83	150
CFM-60S240	90...264	24.0	2500	85	240
CFM-60S240-M	90...264	24.0	2500	85	240
CFM-60S300	90...264	30.0	2000	86	300
CFM-60S360	90...264	36.0	1670	86	360
CFM-60S480	90...264	48.0	1250	87	480
Triple Output	VAC	VDC	mA	%	mV _{pp}
CFM-60T-04	90...264	3.3	6000	-	50
		5.0	3500		50
		-12.0	500		120
CFM-60T-01	90...264	5.0	4000	-	50
		12.0	3000		120
		-12.0	500		120
CFM-60T-02	90...264	5.0	4000	-	50
		15.0	2500		150
		-15.0	300		150
CFM-60T-03	90...264	5.0	4000	-	50
		24.0	1500		240
		-12.0	500		120

100 Watt**CFM-Series****Open frame modules with universal input range and active PFC**

- 90 to 264 VAC universal input range
- 47-63 Hz
- Power factor correction (PFC)
- Molex connectors
- Short Circuit Protection
- High efficiency
- **Dimensions: 102 x 51 x 28 mm**

Model	U _{in}	U _{out}	I _{out}	η typ.	Ripple
Single Output	VAC	VDC	A	%	mVpp
CFM-101S120	90...264	12	8.4	87	120
CFM-101S150	90...264	15	6.7	87	150
CFM-101S200	90...264	20	5.0	88	200
CFM-101S240	90...264	24	4.2	88	240
CFM-101S480	90...264	48	2.1	88	480

200 Watt**CFM-Series****Open frame modules with universal input range and active PFC**

- 90 to 264 VAC universal input range
- Active PFC
- Remote Voltage Sense
- High efficiency up to 92 % typical
- Option: with cover
- **Dimensions:**
Open frame versions (127 x 76.2 x 36.6 mm)
Covered versions (136 x 88 x 49 mm)

Model	U _{in}	U _{out}	I _{out}	η typ.	Ripple
Single Output	VAC	VDC	A	%	mVpp
CFM-201S120	90...264	12	16.67	89	120
CFM-201S240	90...264	24	8.34	90	150
CFM-201S360	90...264	36	5.56	91	200
CFM-201S480	90...264	48	4.17	92	240

350 Watt**CFM-Series****U-Frame modules with universal input range and active PFC**

- 90 to 264 VAC universal input range
- Active PFC
- 1U low profile
- Remote voltage sense
- High efficiency up to 90 %
- **Dimensions: 235.2 x 101.6 x 40.0 mm**

Model	U _{in}	U _{out}	I _{out}	η typ.	Ripple
Single Output	VAC	VDC	A	%	mVpp
CFM-350S120	90...264	12	29.20	88	150
CFM-350S150	90...264	15	23.35	88	150
CFM-350S240	90...264	24	14.60	90	150
CFM-350S360	90...264	36	9.73	90	150
CFM-350S480	90...264	48	7.30	91	150

5-6 Watt

CFM medical-Series



Cost-effective medical open frame modules with universal input range

- 85-264 VAC universal input range
- 47-63 Hz
- 5'656 VDC input to output isolation
- EMC according to EN55011 Class B
- Through-hole pinning
- UL/cUL certified
- CE certified

• **Dimensions: 55 x 35 x 21 mm**

Model	U _{in}	U _{out}	I _{out}	η typ.	Ripple
Single Output	VAC	VDC	mA	%	mVpp
CFM-05S033-M	85...264	3.3	1250	70	50
CFM-05S050-M	85...264	5.0	1000	73	50
CFM-05S090-M	85...264	9.0	550	76	90
CFM-05S120-M	85...264	12.0	420	77	120
CFM-05S150-M	85...264	15.0	330	78	150
CFM-05S180-M	85...264	18.0	280	78	180
CFM-05S240-M	85...264	24.0	230	80	240

40 Watt

CFM medical-Series



Cost-effective medical open frame modules with universal input range

- 90 to 264 VAC universal input range
- 47-63 Hz
- 5'656 VDC input to output isolation
- EMC according to EN55011 Class B
- Molex connectors
- High efficiency
- UL/cUL certified
- CE certified

• **Dimensions: 76.2 x 50.8 x 23.1 mm**

Model	U _{in}	U _{out}	I _{out}	η typ.	Ripple
Single Output	VAC	VDC	mA	%	mVpp
CFM-40M033	90...264	3.3	6000	76	50
CFM-40M050	90...264	5.0	6000	80	50
CFM-40M090	90...264	9.0	4450	84	90
CFM-40M120	90...264	12.0	3340	86	120
CFM-40M150	90...264	15.0	2670	87	150
CFM-40M240	90...264	24.0	1670	88	240
CFM-40M300	90...264	30.0	1330	88	300
CFM-40M360	90...264	36.0	1110	88	360
CFM-40M480	90...264	48.0	834	88	480

60 Watt

CFM medical-Series



Cost-effective medical open frame modules with universal input range

- 90 to 264 VAC universal input range
- 47-63 Hz
- 5'656 VDC input to output isolation
- EMC according to EN55011 Class B
- Molex connectors
- High efficiency
- UL/cUL certified
- CE certified

• **Dimensions: 102 x 51 x 28 mm**

Model	U _{in}	U _{out}	I _{out}	η typ.	Ripple
Single Output	VAC	VDC	mA	%	mVpp
CFM-60M050	90...264	5	8000	82	50
CFM-60M120	90...264	12	5000	87	120
CFM-60M150	90...264	15	4000	88	150
CFM-60M240	90...264	24	2500	89	240
CFM-60M480	90...264	48	1250	90	480

100 Watt**CFM medical-Series****Cost-effective medical & ITE open frame modules with PFC**

- 90 to 264 VAC universal input range
- 47-63 Hz
- Active PFC Meets EN61000-3-2 Class D
- 5'656 VAC input to output isolation
- EMC according to EN55022 Class B
- Molex connectors
- High efficiency
- UL/cUL certified
- CE certified

• **Dimensions: 127 x 76.2 x 26.7 mm**

Model	U _{in}	U _{out}	I _{out}	η typ.	Ripple
Single Output	VAC	VDC	A	%	mVpp
CFM-100M050	90...264	5.0	20.0	85	100
CFM-100M075	90...264	7.5	13.4	87	150
CFM-100M090	90...264	9.0	11.2	88	90
CFM-100M120	90...264	12.0	8.4	89	120
CFM-100M150	90...264	15.0	6.7	89	150
CFM-100M180	90...264	18.0	5.6	90	180
CFM-100M240	90...264	24.0	4.2	91	240
CFM-100M280	90...264	28.0	3.6	91	280
CFM-100M360	90...264	36.0	2.8	91	360
CFM-100M480	90...264	48.0	2.1	91	480

350 Watt**CFM medical-Series****Cost-effective medical open frame modules with universal input range**

- 90 to 264 VAC universal input range
- 47-63 Hz
- 5'656 VDC input to output isolation
- EMC according to EN55011 Class B
- Remote Voltage Sense
- PS ON/OFF Remote Control
- +5V Stand-by Output Power
- 12V fan output
- High efficiency
- UL/cUL certified
- CE certified

• **Dimensions: 165 x 101.6 x 38.6 mm**

Model	U _{in}	U _{out}	I _{out}	η typ.	Ripple
Single Output	VAC	VDC	A	%	mVpp
CFM-351M050	90...264	5	60.0/40.00	88	100
CFM-351M120	90...264	12	29.2/25.00	92	120
CFM-351M240	90...264	24	14.6/12.50	93	150
CFM-351M480	90...264	48	7.3/6.25	93	150

750 Watt**CFM 750-Series****Enclosed modules with universal input range and active PFC**

- 90 to 264 VAC universal input range
- Active PFC
- 1U Low Profile, High Power Density
- Remote voltage sense
- PS on/off Remote Control
- Active Current Sharing
- I2C bus Interface
- High efficiency up to 91 %
- **Dimensions (L x W x H): 35.2 x 101.6 x 40.4 mm**

Model	U _{in}	U _{out}	I _{out}	η typ.
Single Output	VAC	VDC	A	%
CFM-750E240	90...264	24	31.2	91
CFM-750E360	90...264	36	20.8	91
CFM-750E480	90...264	48	15.6	91

1600 Watt**CFM 1600-Series****AC/DC modules with universal input range and active PFC**

- 90 to 264 VAC universal input range
- Active PFC
- 1U low profile
- Remote voltage sense
- active current sharing
- i2bus interface
- fan speed control, optional
- standby output voltage 5Vdc
- High efficiency up to 92%
- hot swap redundancy
- optional 1Ux19" power rack
- **Dimensions (L x W x H): 292 x 140.7 x 42 mm**

Model	U _{in}	U _{out}	I _{out}	η typ.
Single Output	VAC	VDC	A	%
CFM-1600H-480-24P	90...264	48	33.3	89

36 Watt**TRG36-Series****36W Switching Adapter, desktop type**

- Universal input: 90-264 VAC, 47-63 Hz
- EMI meets EN55022 Class B and CISPR/FCC Class B
- Meet CEC & Erp Level V
(output cable length = 1800 mm AWG18, TRG36A090: 1220 mm, TRG36A050: 720 mm AWG18)
- AC inlet IEC320/C8
- Leakage current 0.25mA
- I/O isolation of 4'242 VDC
- Efficiency up to 83 %
- Over voltage protection
- Short circuit protection continuous
- Derating above 40 °C ambient temperature
- Provide PSE Mark

Model	U _{in}	U _{out}	I _{out}	η typ.	Ripple
Single Output	VAC	VDC	mA	%	mVpp
TRG36A05	90...264	5.0	4000	73	50
TRG36A09	90...264	9.0	3000	77	90
TRG36A12	90...264	12.0	2500	78	120
TRG36A13	90...264	13.5	2400	80	140
TRG36A15	90...264	15.0	2400	80	150
TRG36A18	90...264	18.0	2000	81	180
TRG36A24	90...264	24.0	1500	81	240
TRG36A48	90...264	48.0	750	83	480

45 Watt**TRG45-Series****45W Switching Adapter, desktop type**

- Universal input: 90-264 VAC, 47-63 Hz
- EMI meets EN55022 Class B and CISPR/FCC Class B
- Meet CEC & Erp Level V
(output cable length = 1800 mm AWG18, TRG45A120: 720 mm, TRG45A120: 720 mm AWG16)
- AC inlet IEC320/C13
- I/O isolation of 4'242 VDC
- Efficiency up to 87 %
- Over voltage protection
- Short circuit protection continuous
- Derating above 40 °C ambient temperature

Model	U _{in}	U _{out}	I _{out}	η typ.	Ripple
Single Output	VAC	VDC	mA	%	mVpp
TRG45A120	90...264	12	3750	84	120
TRG45A150	90...264	15	3000	85	150
TRG45A180	90...264	18	2500	85	180
TRG45A190	90...264	19	2370	85	190
TRG45A240	90...264	24	1880	86	240
TRG45A480	90...264	48	1000	87	480

70 Watt**TRG70-Series****70W Switching Adapter, desktop type**

- Universal input: 90-264 VAC, 47-63 Hz
- EMI meets EN55022 Class B and CISPR/FCC Class B
- Meet CEC & Erp Level V
(output cable length = 1800 mm, TRG70A120: 720 mm AWG16, TRG70A150: 1220 mm AWG16)
- AC inlet IEC320/C13
- I/O isolation of 4'242 VDC
- Efficiency up to 87 %
- Over voltage protection
- Short circuit protection continuous
- Derating above 40 °C ambient temperature

Model	U _{in}	U _{out}	I _{out}	η typ.	Ripple
Single Output	VAC	VDC	mA	%	mV _{pp}
TRG70A120	90...264	12	5500	85	120
TRG70A150	90...264	15	4600	85	150
TRG70A180	90...264	18	3900	85	180
TRG70A190	90...264	19	3700	85	190
TRG70A240	90...264	24	3000	86	240
TRG70A480	90...264	48	1500	87	480

70 Watt**TRG70E-Series****70W Switching Adapter, desktop type**

- Universal input: 90-264 VAC, 47-63 Hz
- EMI meets EN55022 Class B and CISPR/FCC Class B
- Meet CEC & Erp Level V
(output cable length = 1800 mm, TRG70A120: 720 mm AWG16, TRG70A150: 1220 mm AWG16)
- AC inlet IEC320/C13
- I/O isolation of 4'242 VDC
- Efficiency up to 87 %
- Over voltage protection
- Short circuit protection continuous
- Derating above 40 °C ambient temperature

Model	U _{in}	U _{out}	I _{out}	η typ.	Ripple
Single Output	VAC	VDC	mA	%	mV _{pp}
TRG70A120	90...264	12	5500	82	120
TRG70E150	90...264	15	4600	83	150
TRG70E150	90...264	15	4600	83	150
TRG70E180	90...264	18	3900	84	180
TRG70E190	90...264	19	3600	84	190
TRG70E240	90...264	24	3000	86	240
TRG70E480	90...264	48	1500	87	480

100 Watt**TRG100A-Series****100 W Switching Adapter, desktop type**

- Universal input: 90-264 VAC, 47-63 Hz
- EMI meets EN55022 Class B and CISPR/FCC Class B
- Active PFC meets EN61000-3-2
- Meet CEC & Erp Level V
(output cable length = 1800 mm, TRG100A120/150: 1220 mm)
- AC inlet IEC320/C13
- I/O isolation of 4'242 VDC
- Efficiency up to 87 %
- Over voltage protection
- Short circuit protection continuous
- Derating above 40 °C ambient temperature

Model	U _{in}	U _{out}	I _{out}	η typ.	Ripple
Single Output	VAC	VDC	mA	%	mVpp
TRG100A120	90...264	12.0	8340	87	120
TRG100A125	90...264	12.5	8000	87	125
TRG100A135	90...264	13.5	7330	87	135
TRG100A150	90...264	15.0	6670	87	150
TRG100A180	90...264	18.0	5560	87	180
TRG100A190	90...264	19.0	5210	87	190
TRG100A200	90...264	20.0	5000	87	200
TRG100A240	90...264	24.0	4170	87	240
TRG100A280	90...264	28.0	3540	87	280
TRG100A290	90...264	29.0	3410	87	290
TRG100A300	90...264	30.0	3300	87	300
TRG100A360	90...264	36.0	2780	87	360
TRG100A480	90...264	48.0	2080	87	480
TRG100A540	90...264	54.0	1850	87	540

150 Watt**TRG150A-Series****150 W Switching Adapter, desktop type**

- Universal input: 90-264 VAC, 47-63 Hz
- EMI meets EN55022 Class B and CISPR/FCC Class B
- Active PFC meets EN61000-3-2
- Meet CEC & Erp Level V
(output cable length = 1800 mm, TRG150A120: 950 mm, TRG100A150-190: 1220 mm)
- AC inlet IEC320/C13
- I/O isolation of 4'242 VDC
- Efficiency up to 87 %
- Over voltage protection
- Short circuit protection continuous
- Derating above 40 °C ambient temperature

Model	U _{in}	U _{out}	I _{out}	η typ.	Ripple
Single Output	VAC	VDC	A	%	mVpp
TRG150A120	90...264	12	12.50	87	240
TRG150A150	90...264	15	10.00	87	300
TRG150A180	90...264	18	8.34	87	360
TRG150A190	90...264	19	7.90	87	380
TRG150A240	90...264	24	6.25	87	480
TRG150A280	90...264	28	5.36	87	560
TRG150A300	90...264	30	5.00	87	600
TRG150A360	90...264	36	4.17	87	720
TRG150A480	90...264	48	3.13	87	960

21 Watt**TRG21-Series****21 W Medical Switching Adapter, desktop type**

- Universal input: 90-264 VAC, 47-63 Hz
- EMI meets EN55022 Class B
- Meet CEC & Erp Level V
(output cable length = 1800 mm AWG18, TRG21A050: 1220 mm AWG18)
- AC inlet IEC320/C8
- No load input power < 0.3 W
- Leakage current < 0.1 mA
- I/O isolation of 5'656 VDC
- Efficiency up to 85 %
- Over voltage protection
- Short circuit protection continuous
- Derating above 40 °C ambient temperature

Model	U _{in}	U _{out}	I _{out}	η typ.	Ripple
Single Output	VAC	VDC	mA	%	mVpp
TRG21A050	90...264	5	3000	75	50
TRG21A090	90...264	9	2300	80	50
TRG21A120	90...264	12	1800	81	90
TRG21A150	90...264	15	1400	83	100
TRG21A180	90...264	18	1200	84	100
TRG21A240	90...264	24	900	85	100

30 Watt**TR30M-Series****30 W Medical Switching Adapter, desktop type**

- Universal input: 90-264 VAC, 47-63 Hz
- AC inlet IEC320/C8, 2 pole
- Meets EN60601-1
- EMI meets EN55022 Class B
- Meet CEC Level III (except TR30M50. Output cable length = 1800 mm)
- Meet Erp Level V (output cable length = 1800 mm, TR30M050: 720 mm, TR30M090: 1220mm)
- I/O isolation of 5'656 VDC
- Efficiency up to 82 %
- Over voltage protection
- Short circuit protection continuous
- Derating above 40 °C ambient temperature
- Provides PSE Mark

Model	U _{in}	U _{out}	I _{out}	η typ.	Ripple
Single Output	VAC	VDC	mA	%	mVpp
TR30M050	90...264	5	4000	73	50
TR30M090	90...264	9	3000	77	90
TR30M120	90...264	12	2500	77	120
TR30M150	90...264	15	2000	80	150
TR30M180	90...264	18	1650	80	180
TR30M240	90...264	24	1250	82	240

60 Watt**TR60M-Series****60W Medical switching adapter, desktop type**

- Universal input: 90-264 VAC, 47-63 Hz
- AC inlet IEC320/C8, 2 pole
- Meets EN60601-1
- EMI meets EN55022 Class B
- Meet CEC Level IV (except TR60M50. Output cable length = 1800 mm)
- Meet Erp Level V (except TR60M50. Output cable length = 1800 mm, TR60M120: 720 mm, TR60M150: 1220 mm, TR60M180/190: 1500 mm)
- I/O isolation of 5'656 VDC
- Efficiency up to 87 %
- Over voltage protection
- Short circuit protection continuous
- Derating above 40° C ambient temperature

Model	U _{in}	U _{out}	I _{out}	η typ.	Ripple
Single Output	VAC	VDC	mA	%	mVpp
TR60M050	90...264	5	6000	71	50
TR60M120	90...264	12	5000	83	120
TR60M150	90...264	15	4000	84	150
TR60M180	90...264	18	3330	84	180
TR60M190	90...264	19	3150	85	190
TR60M240	90...264	24	2500	85	240
TR60M360	90...264	36	1660	86	360
TR60M480	90...264	48	1250	87	480

10 Watt**TRG10R-Series****10W Switching adapter, wall mounted**

- Universal input: 90-264 VAC, 47-60 Hz
- Interchangeable AC plugs
- EMI meets EN55022 Class B and CISPR/FCC Class B
- Meet CEC & Erp Level V (output cable length = 1800 mm)
- I/O isolation of 4'242 VDC
- Efficiency up to 77 %
- Over voltage protection
- Short circuit protection continuous.
- Derating above 40 °C ambient temperature
- Provides PSE Mark

Model	U _{in}	U _{out}	I _{out}	η typ.	Ripple
Single Output	VAC	VDC	mA	%	mV _{pp}
TRG10R050	90...264	5.0	1600	75	50
TRG10R060	90...264	6.0	1500	75	60
TRG10R075	90...264	7.5	1200	75	75
TRG10R090	90...264	9.0	1100	76	90
TRG10R120	90...264	12.0	850	76	120
TRG10R136	90...264	13.6	750	76	140
TRG10R150	90...264	15.0	700	77	150
TRG10R180	90...264	18.0	550	77	180
TRG10R240	90...264	24.0	400	77	240

15 Watt**TRG15-Series****15W Switching adapter, wall mounted**

- Universal input: 90-264 VAC, 47-60 Hz
- EMI meets EN55022 Class B and CISPR/FCC Class B
- Meet CEC & Erp Level V (output cable length = 1800 mm)
- I/O isolation of 4'242 VDC
- Efficiency up to 83 %
- Over voltage protection
- Short circuit protection continuous, hiccup mode
- Derating above 40 °C ambient temperature

Model	U _{in}	U _{out}	I _{out}	η typ.	Ripple
Single Output	VAC	VDC	mA	%	mV _{pp}
TRG1505	90...264	5.0	2000	72	50
TRG1506	90...264	6.0	1700	76	60
TRG1507	90...264	7.5	1600	77	75
TRG1509	90...264	6.0	1400	77	90
TRG1512	90...264	12.0	1000	80	120
TRG1512-01	90...264	13.6	1000	81	140
TRG1515	90...264	15.0	1000	81	150
TRG1518	90...264	18.0	830	83	180
TRG1524	90...264	24.0	630	83	240

15 Watt**TRG15RA-Series****15W Switching adapter, wall mounted**

- Universal input: 90-264 VAC, 47-63 Hz
- Interchangeable AC plugs
- EMI meets EN55022 Class B
- Meet CEC & Erp Level V (output cable length = 1800 mm)
- I/O isolation of 4'242 VDC
- Efficiency up to 80 %
- Over voltage protection
- Short circuit protection continuous
- Derating above 40 °C ambient temperature

Model	U _{in}	U _{out}	I _{out}	η typ.	Ripple
Single Output	VAC	VDC	mA	%	mV _{pp}
TRG15RA050	90...264	5.0	2000	73	50
TRG15RA060	90...264	6.0	1700	74	60
TRG15RA090	90...264	9.0	1400	77	90
TRG15RA120	90...264	12.0	1100	78	120
TRG15RA150	90...264	15.0	1000	79	150
TRG15RA180	90...264	18.0	830	79	180
TRG15RA240	90...264	24.0	630	80	240

25 Watt**TRG25-Series****25W Switching adapter, wall mounted**

- Universal input: 90-264 VAC, 47-63 Hz
- EMI meets EN55022 Class B and CISPR/FCC Class B
- Meet CEC & Erp Level V
(output cable length = 1800 mm, TRG25033: 720 mm, TRG25050: 1220 mm)
- I/O isolation of 4'242 VDC
- Efficiency up to 84 %
- Over voltage protection
- Short circuit protection continuous
- Derating above 40 °C ambient temperature

Model	U _{in}	U _{out}	I _{out}	η typ.	Ripple
Single Output	VAC	VDC	mA	%	mVpp
TRG25033	90...264	3.3	4000	72	50
TRG25050	90...264	5.0	4000	75	50
TRG250120	90...264	12.0	2100	81	120
TRG250150	90...264	15.0	1670	82	150
TRG250180	90...264	18.0	1400	82	180
TRG250240	90...264	24.0	1050	84	240

30 Watt**TRG30RAV-Series****30W Switching adapter, wall mounted**

- Universal input: 90-264 VAC, 47-63 Hz
- Interchangeable AC plugs
- EMI meets EN55022 Class B and CISPR/FCC Class B
- Meet CEC & Erp Level V
(output cable length = 1800 mm, TRG30RA050V, TRG30RA090V: 1220 mm)
- I/O isolation of 4'242 VDC
- Efficiency up to 80 %
- Over voltage protection
- Short circuit protection continuous
- Derating above 40 °C ambient temperature

Model	U _{in}	U _{out}	I _{out}	η typ.	Ripple
Single Output	VAC	VDC	mA	%	mVpp
TRG30RA050V	90...264	5	4000	80	50
TRG30RA090V	90...264	9	3000	84	90
TRG30RA120V	90...264	12	2500	84	120
TRG30RA150V	90...264	15	2000	85	150
TRG30RA180V	90...264	18	1670	85	180
TRG30RA240V	90...264	24	1250	86	240

30 Watt**TRG30RV-Series**

Model	U _{in}	U _{out}	I _{out}	η typ.	Ripple
Single Output	VAC	VDC	mA	%	mV _{pp}
TRG30R090V	90...264	9	3000	84	90
TRG30R120V	90...264	12	2500	84	120
TRG30R150V	90...264	15	2000	85	150
TRG30R180V	90...264	18	1.67	85	180
TRG30R240V	90...264	24	1.25	86	240

30W Switching adapter, wall mounted

- Universal input: 90-264 VAC, 47-63 Hz
- Interchangeable AC plugs
- EMI meets EN55022 Class B and CISPR/FCC Class B
- Meet CEC & Erp Level V
(output cable length = 1800 mm, TRG30R050V, TRG30R090V: 1220 mm)
- I/O isolation of 4'242 VDC
- Efficiency up to 86 %
- Over voltage protection
- Short circuit protection continuous
- Derating above 40 °C ambient temperature

15 Watt**TR15RAM-Series****15W Medical switching adapter, wall mounted**

- Universal input: 90-264 VAC, 47-63 Hz
- Interchangeable AC plugs
- Meets EN60601-1
- EMI meets EN55022 Class B
- Meet CEC & Erp Level V
(output cable length = 1800 mm)
- I/O isolation of 5'656 VDC
- Efficiency up to 83 %
- Over voltage protection
- Short circuit protection continuous
- Derating above 50 °C ambient temperature
- Provides PSE Mark

Model	U _{in}	U _{out}	I _{out}	η typ.	Ripple
Single Output	VAC	VDC	mA	%	mVpp
TR15RAM050	90...264	5	2000	73	50
TR15RAM120	90...264	12	1100	83	120
TR15RAM150	90...264	15	1000	82	150
TR15RAM240	90...264	24	625	82	240

30 Watt**TR30RAM-Series****30W Medical switching adapter, wall mounted**



- Universal input: 90-264 VAC, 47-63 Hz
- Interchangeable AC plugs
- Meets EN60601-1
- EMI meets EN55022 Class B
- Meet CEC & Erp Level V
(output cable length = 1800 mm)
- I/O isolation of 5'656 VDC
- Efficiency up to 83 %
- Over voltage protection
- Short circuit protection continuous
- Derating above 50 °C ambient temperature
- Provides PSE Mark

Model	U _{in}	U _{out}	I _{out}	η typ.	Ripple
Single Output	VAC	VDC	mA	%	mVpp
TR30RAM050	90...264	5	4000	73	50
TR30RAM090	90...264	9	3000	76	90
TR30RAM120	90...264	12	2500	79	120
TR30RAM150	90...264	15	2000	81	150
TR30RAM240	90...264	24	1250	83	240

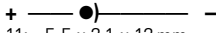
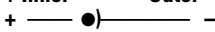
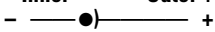
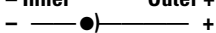
WALL MOUNT TYPE AC ADAPTER

TRXXXX	X	XX	X	XX
Model No.	AC Plug Type	DC Plug Type	OVP Option	DC Cable Length and Type
A: USA 2 Pin E: Europe 2 Pin U: British 3 Pin S: Australia 2 Pin		Straight/ + Inner Outer - 	A: Without OVP Option E: With OVP Option	01: 720 mm 02: 1'200 mm 03: 1'800 mm 11: 720 mm with Ferrite Core 12: 1'200 mm with Ferrite Core 13: 1'800 mm with Ferrite Core
		128: 4.0 x 1.7 x 9.5 mm 129: 3.5 x 1.1 x 7.5 mm 136: 3.5 x 1.35 x 9 mm 147: 3.0 x 1.1 x 9 mm 329: 3.8 x 1.05 x 9.5 mm 62: Open end XX: For special plugs, please inquire your distributor		
		Right Angle/ + Inner Outer - 		
		01: 5.5 x 2.1 x 12 mm 02: 5.5 x 2.5 x 12 mm 17: 5.5 x 2.1 x 11 mm 19: 5.5 x 2.5 x 10.5 mm 20: 5.5 x 2.5 x 9 mm 21: 5.5 x 2.5 x 9.5 mm 24: 5.5 x 2.1 x 9.5 mm 31: 3.5 x 1.35 x 7.5 mm 34: 5.5 x 2.1 x 11.5 mm 36: 3.5 x 1.35 x 9 mm 38: 3.5 x 1.7 x 9 mm 40: 4.0 x 1.7 x 9.5 mm 42: 3.5 x 1.35 x 9.5 mm 46: 4.0 x 1.7 x 12 mm 48: 5 x 1.5 x 9.5 mm 49: 2.35 x 0.7 x 9.5 mm 103: 3.5 x 1.05 x 9.5 mm 106: 4.0 x 1.7 x 10 mm 109: 5.5 x 2.2 x 11 mm 110: 6.5 x 3.0 x 9.5 mm 112: 6.5 x 3.0 x 10 mm 114: 3.0 x 1.1 x 10 mm 117: 3.5 x 1.3 x 9 mm 138: 3.5 x 1.35 x 12 mm 142: 3.8 x 1.1 x 10 mm 148: 3.5 x 1.35 x 10 mm 303: 4.75 x 1.7 x 11 mm 304: 5.5 x 2.1 x 9 mm 305: 3.5 x 1.3 x 8 mm 309: 5.5 x 2.5 x 11 mm 324: 4.0 x 1.7 x 11 mm 501: 3.5 x 1.35 x 6.5 mm 503: 5.5 x 2.1 x 9.5 mm 507: 3.5 x 1.1 x 9 mm 509: 3.5 x 1.35 x 11.5 mm 512: 6.3 x 3.0 x 12 mm 513: 3.5 x 1.1 x 9.5 mm		
		Right Angle/ - Inner Outer + 		
		03: 5.5 x 2.1 x 12 mm 04: 5.5 x 2.5 x 12 mm 16: 5.5 x 2.1 x 11 mm 22: 5.5 x 2.5 x 9.5 mm 43: 5.5 x 2.1 x 9.5 mm 44: 3.5 x 1.35 x 7.5 mm 105: 3.5 x 1.05 x 9.5 mm 111: 3.5 x 1.35 x 9.5 mm 122: 3.5 x 1.35 x 12 mm 141: 5.5 x 2.1 x 11 mm 150: 3.5 x 1.35 x 9 mm 317: 5.5 x 2.5 x 9 mm		
		Straight/ - Inner Outer + 		
		05: 5.5 x 2.1 x 12 mm 13: 5.5 x 2.1 x 12 mm 14: 5.5 x 2.5 x 12 mm 27: 5.5 x 2.5 x 9.5 mm 102: 5.5 x 2.1 x 9.5 mm 108: 3.5 x 1.35 x 7.5 mm 117: 2.5 x 0.7 x 9 mm		

DESK TOP TYPE AC ADAPTER

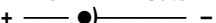
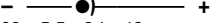
TRXXXXX Model No.	XX DC Plug Type	X OVP Option	XX DC Cable Length and Type	
	Straight/ + Inner Outer -  11: 5.5 x 2.1 x 12 mm 12: 5.5 x 2.5 x 12 mm 18: 5.5 x 2.5 x 11 mm 23: 5.5 x 2.1 x 9.5 mm 26: 5.5 x 2.5 x 9.5 mm 32: 5.5 x 2.1 x 7.5 mm 33: 5.5 x 2.1 x 11.5 mm 35: 4.0 x 1.7 x 9.5 mm 37: 5.5 x 2.5 x 7.5 mm 39: 3.5 x 1.35 x 9 mm 41: 3.5 x 1.35 x 7.5 mm 45: 4.75 x 1.7 x 9.5 mm 50: 4.0 x 1.7 x 11 mm 104: 5.5 x 2.1 x 14 mm 107: 6.3 x 3.0 x 12 mm 113: 5.5 x 2.5 x 14 mm 115: 3.0 x 1.1 x 10 mm 116: 3.5 x 1.35 x 9.5 mm 118: 6.5 x 3 x 11 mm 119: 4.0 x 1.35 x 7.5 mm 120: 4.0 x 1.35 x 9.5 mm 121: 3.8 x 1.35 x 9.5 mm 123: 3.5 x 0.7 x 8 mm 124: 3.5 x 1.1 x 11 mm 125: 6.2 x 1.9 x 14 mm 126: 3.5 x 1.35 x 8.4 mm 127: 2.35 x 0.7 x 9.5 mm 130: 3.4 x 1.35 x 10 mm 131: 5.5 x 2.5 x 11 mm 133: 3.5 x 1.35 x 9 mm 134: 3.5 x 1.35 x 10 mm 137: 4.75 x 1.7 x 12 mm 140: 5.5 x 1.0 x 9.5 mm 143: 4.0 x 1.7 x 10 mm 144: 3.5 x 1.35 x 12 mm 146: 3.5 x 1.35 x 14 mm 149: 2.5 x 0.7 x 9 mm 301: 6.5 x 3.0 x 9.5 mm 311: 3.5 x 1.35 x 6 mm 312: 5.5 x 2.1 x 11 mm 319: 3.5 x 1.9 x 9.0 mm 330: 3.5 x 1.35 x 6.5 mm 331: 3.0 x 1.1 x 8.5 mm 333: 3.5 x 1.1 x 7.5 mm 334: 3.5 x 1.1 x 8.7 mm 335: 3.5 x 1.35 x 7 mm 338: 3.5 x 1.35 x 11 mm 340: 5.5 x 2.5 x 11.5 mm 341: 3.5 x 1.1 x 7.6 mm 343: 4.75 x 1.7 x 10 mm 348: 3.5 x 1.3 x 7.5 mm 350: 5.0 x 1.9 x 8 mm Straight/ - Inner Outer +  05: 5.5 x 2.1 x 12 mm 13: 5.5 x 2.1 x 12 mm 14: 5.5 x 2.5 x 12 mm 27: 5.5 x 2.5 x 9.5 mm 102: 5.5 x 2.1 x 9.5 mm 108: 3.5 x 1.35 x 7.5 mm 117: 2.5 x 0.7 x 9 mm	128: 4.0 x 1.7 x 9.5 mm 129: 3.5 x 1.1 x 7.5 mm 136: 3.5 x 1.35 x 9 mm 147: 3.0 x 1.1 x 9 mm 329: 3.8 x 1.05 x 9.5 mm 62: Open end XX: For special plugs, please inquire your distributor Right Angle/ + Inner Outer -  01: 5.5 x 2.1 x 12 mm 02: 5.5 x 2.5 x 12 mm 17: 5.5 x 2.1 x 11 mm 19: 5.5 x 2.5 x 10.5 mm 20: 5.5 x 2.5 x 9 mm 21: 5.5 x 2.5 x 9.5 mm 24: 5.5 x 2.1 x 9.5 mm 31: 3.5 x 1.35 x 7.5 mm 34: 5.5 x 2.1 x 11.5 mm 36: 3.5 x 1.35 x 9 mm 38: 3.5 x 1.7 x 9 mm 40: 4.0 x 1.7 x 9.5 mm 42: 3.5 x 1.35 x 9.5 mm 46: 4.0 x 1.7 x 12 mm 48: 5 x 1.5 x 9.5 mm 49: 2.35 x 0.7 x 9.5 mm 103: 3.5 x 1.05 x 9.5 mm 106: 4.0 x 1.7 x 10 mm 109: 5.5 x 2.2 x 11 mm 110: 6.5 x 3.0 x 9.5 mm 112: 6.5 x 3.0 x 10 mm 114: 3.0 x 1.1 x 10 mm 117: 3.5 x 1.3 x 9 mm 138: 3.5 x 1.35 x 12 mm 142: 3.8 x 1.1 x 10 mm 148: 3.5 x 1.35 x 10 mm 303: 4.75 x 1.7 x 11 mm 304: 5.5 x 2.1 x 9 mm 305: 3.5 x 1.3 x 8 mm 309: 5.5 x 2.5 x 11 mm 324: 4.0 x 1.7 x 11 mm 501: 3.5 x 1.35 x 6.5 mm 503: 5.5 x 2.1 x 9.5 mm 507: 3.5 x 1.1 x 9 mm 509: 3.5 x 1.35 x 11.5 mm 512: 6.3 x 3.0 x 12 mm 513: 3.5 x 1.1 x 9.5 mm Right Angle/ - Inner Outer +  03: 5.5 x 2.1 x 12 mm 04: 5.5 x 2.5 x 12 mm 16: 5.5 x 2.1 x 11 mm 22: 5.5 x 2.5 x 9.5 mm 43: 5.5 x 2.1 x 9.5 mm 44: 3.5 x 1.35 x 7.5 mm 105: 3.5 x 1.05 x 9.5 mm 111: 3.5 x 1.35 x 9.5 mm 122: 3.5 x 1.35 x 12 mm 141: 5.5 x 2.1 x 11 mm 150: 3.5 x 1.35 x 9 mm 317: 5.5 x 2.5 x 9 mm	A: Without OVP Option E: With OVP Option	01: 720 mm 02: 1'200 mm 03: 1'800 mm 11: 720 mm with Ferrite Core 12: 1'200 mm with Ferrite Core 13: 1'800 mm with Ferrite Core 21: 720 mm with Ferrite Core (Only for TR100 Series) 22: 1'200 mm with Ferrite Core (Only for TR100 Series) 23: 1'800 mm with Ferrite Core (Only for TR100 Series)

Typical at 25 °C, nominal line and 75 % load, unless otherwise Specified

All dimensions in mm

Half Brick Case

Vertical Fins Model No.: FH-5861-21

Horizontal Fins Model No.: FH-6158-13

Horizontal Fins Model No.: FH-6158-25

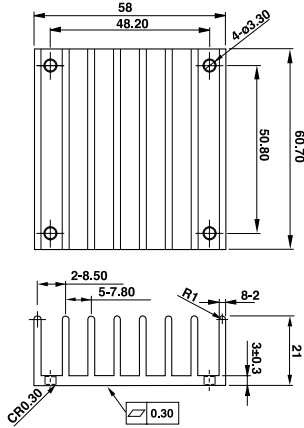

Rca: 3.90 °C/W (typ.), At natural convection
 1.74 °C/W (typ.), At 100LFM
 1.33 °C/W (typ.), At 200LFM
 1.12 °C/W (typ.), At 300LFM
 0.97 °C/W (typ.), At 400LFM

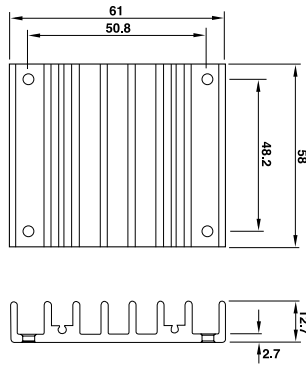

Rca: 4.70 °C/W (typ.), At natural convection
 2.89 °C/W (typ.), At 100LFM
 2.30 °C/W (typ.), At 200LFM
 1.88 °C/W (typ.), At 300LFM
 1.59 °C/W (typ.), At 400LFM

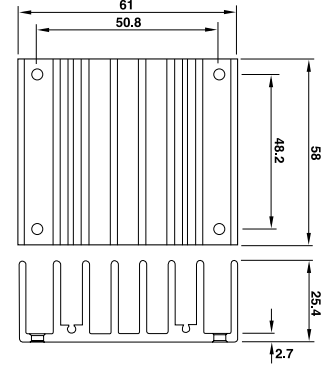

Rca: 3.90 °C/W (typ.), At natural convection
 1.44 °C/W (typ.), At 100LFM
 1.17 °C/W (typ.), At 200LFM
 1.04 °C/W (typ.), At 300LFM
 0.95 °C/W (typ.), At 400LFM

All dimensions in mm

Quarter Brick Case

Vertical Fins Model No.: FH-5837-21

Rca: 4.78 °C/W (typ.), At natural convection
 2.44 °C/W (typ.), At 100LFM
 2.06 °C/W (typ.), At 200LFM
 1.76 °C/W (typ.), At 300LFM
 1.58 °C/W (typ.), At 400LFM

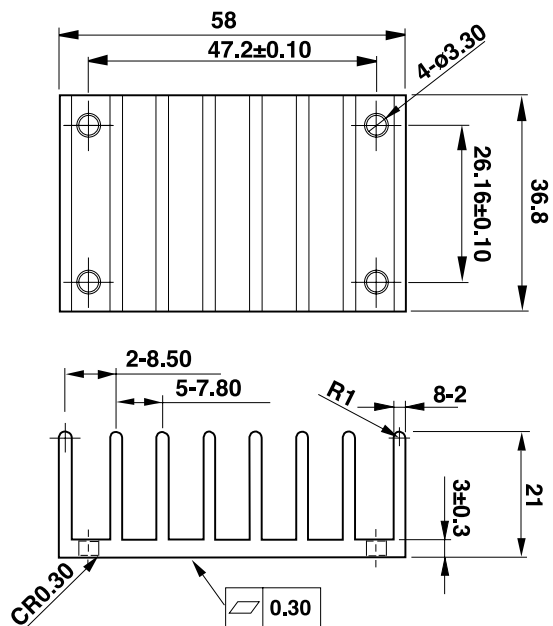

All dimensions in mm

Full Brick

Horizontal Fins Model No.: FH-61117-25

- **Thermal pad**
SR 60×115.8×0.23 (G6135013070)
- **Screw**
SMP+SW M3x8L (75A1300322)
- **Thermal Resistance**
2.07 °C/W (typ.), At natural convection

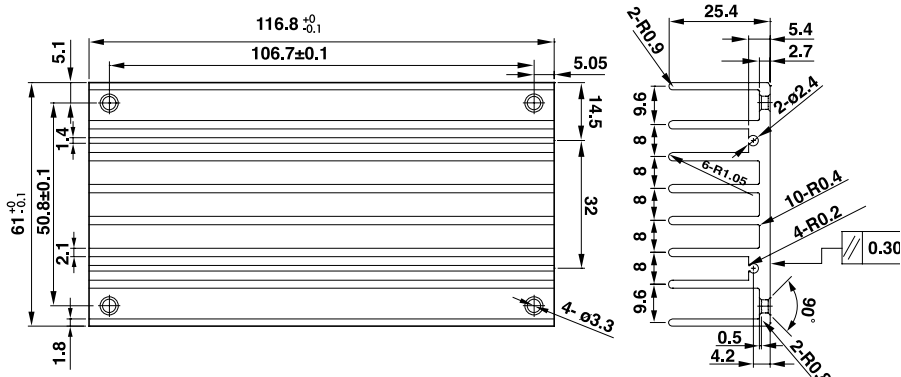

Half Brick Assembly

Horizontal Fins Model No.: FH-61117-25

- **Heat Sink**
FH-5861-21
FH-6158-13
FH-6158.25
- **Thermal pad**
SZ 56.9×60×0.25 mm
- **Screw**
SMP+SW M3x8L

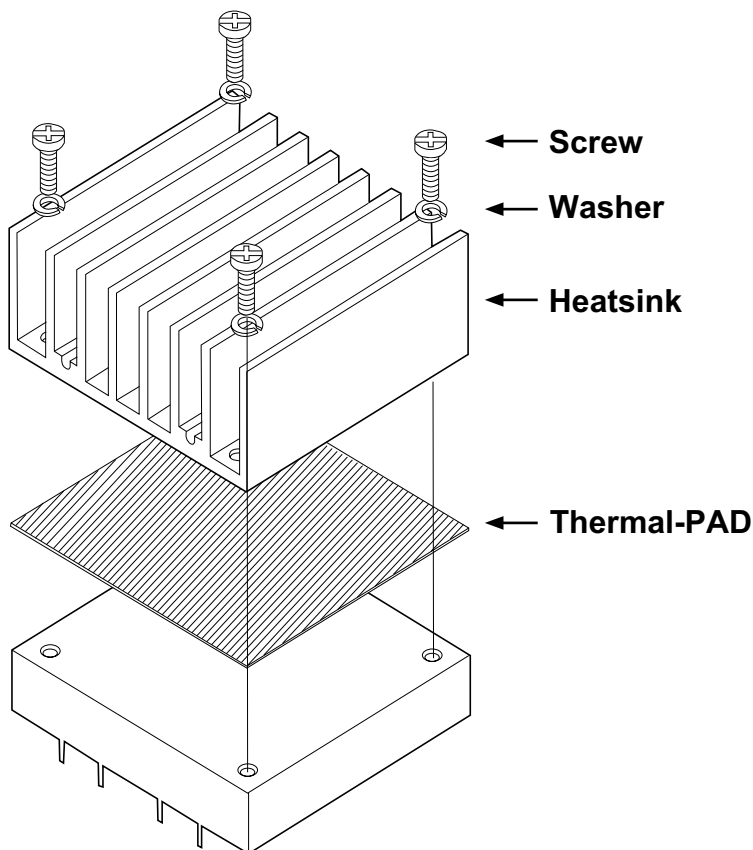

All Specifications Typical At Nominal Line, Full Load and 25 °C Unless Otherwise Noted.

S-4 cases, bottom view

Pinning S4-1
Single Output



Pinning S4-2
Single Output

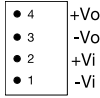

S-7 cases, bottom view

Pinning S7-1
Single Output

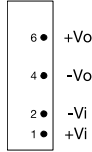

Pinning S7-2
Single Output

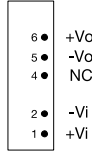

Pinning S7-3
Single Output

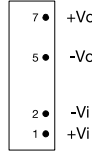

Pinning S7-4
Dual Output

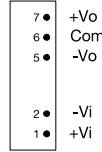

Pinning S7-5
Dual Output

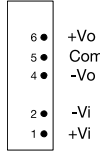

Pinning S7-6
Dual Output

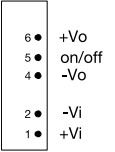

S-8 and S-9 cases, bottom view

Pinning S8-1
Single Output

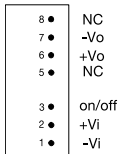

Pinning S8-2
Dual Output

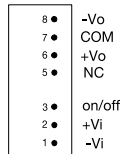

Pinning S9-1
Dual Output

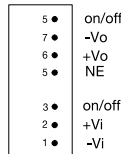

S-11 and S-12 cases, bottom view

Pinning S11

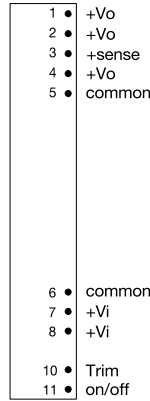

Pinning S12

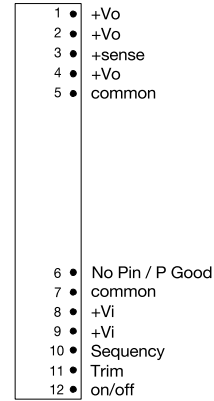

A cases, top view

Pinning A1

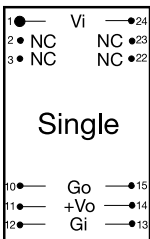

Pinning A2

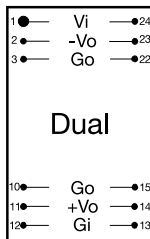

Pinning A3

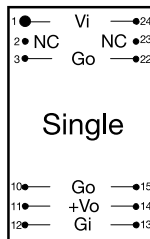

Pinning A4

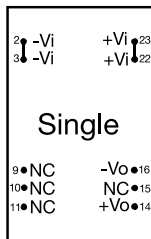

Pinning A5

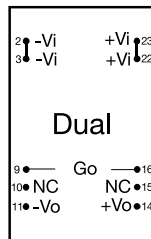

Pinning A6

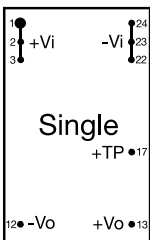

Pinning A7

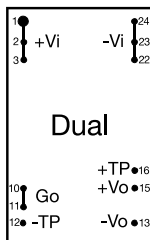

Pinning A8

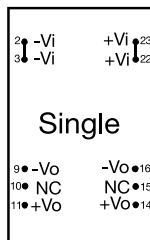

Pinning A9

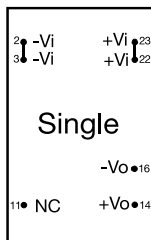

Pinning A10

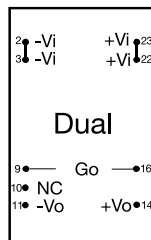

SB cases, bottom view

Pinning SB1

Pinning SB2

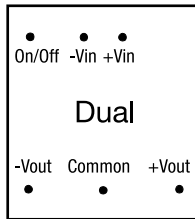
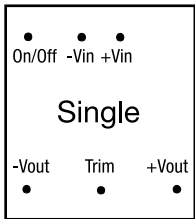

B cases, bottom view

Pinning B1

Pinning B2

Pinning B3

Pinning B4

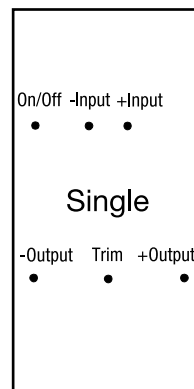
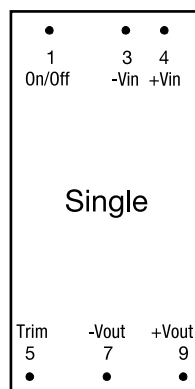
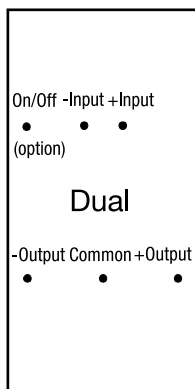
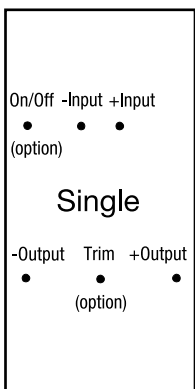

BC cases, bottom view

Pinning BC1

Pinning BC2

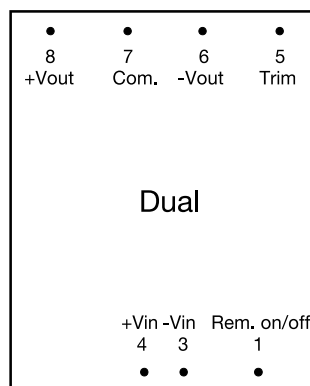
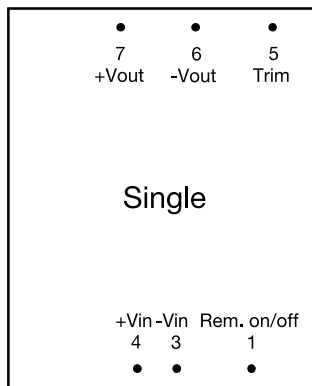

C cases, bottom view

Pinning C1

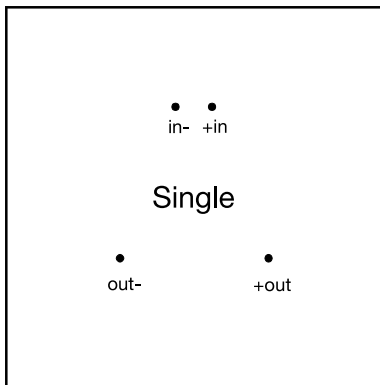

Pinning C2

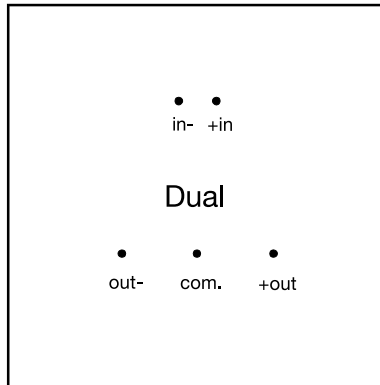

Pinning C5

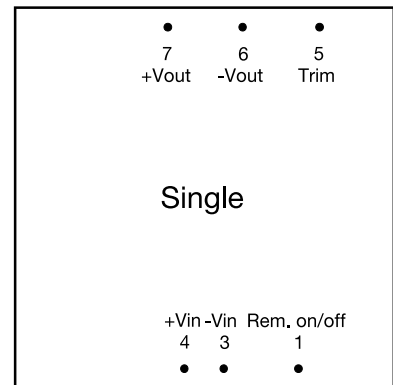

Pinning C6

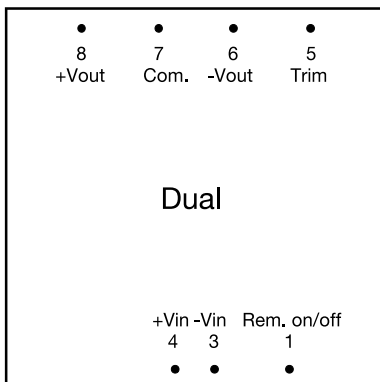

Pinning C7

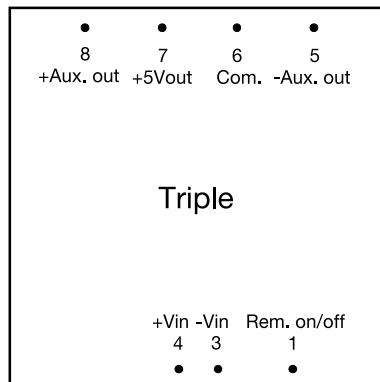

Pinning C8

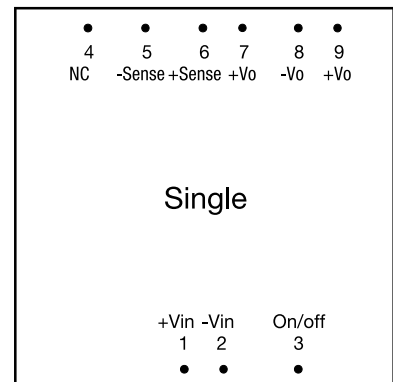

Pinning C9

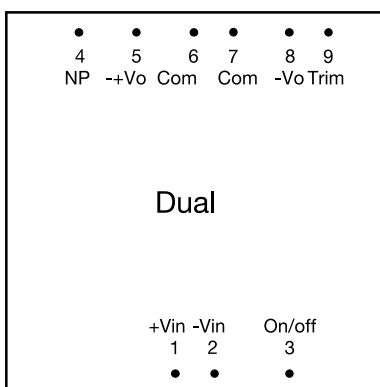

Pinning C10

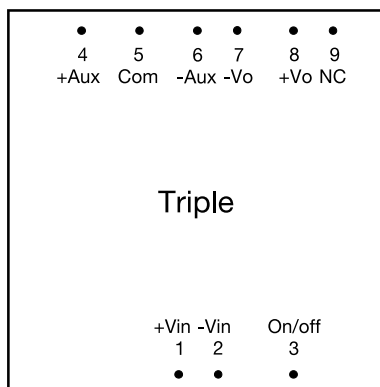

Pinning C11

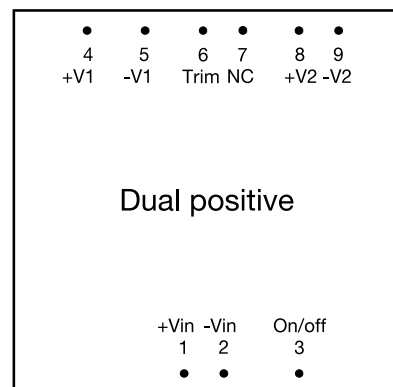

All cases, bottom view

Pinning F1

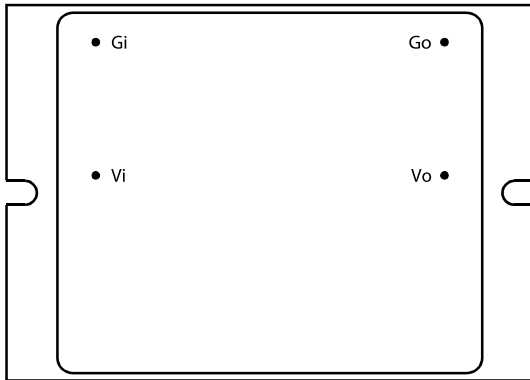

Pinning F2

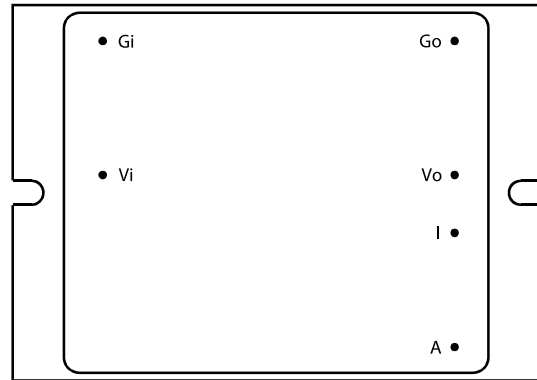

Pinning E1

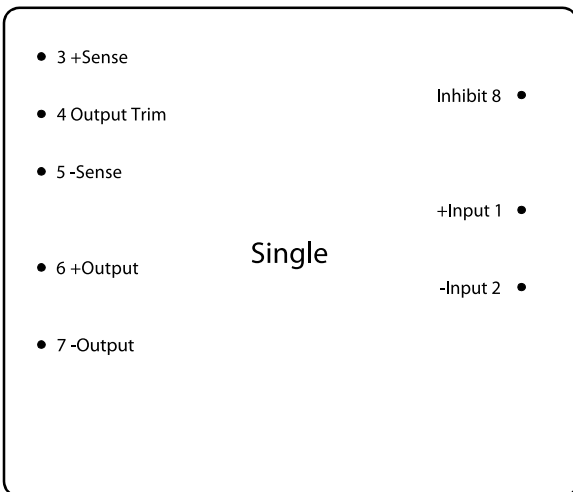

Pinning E2

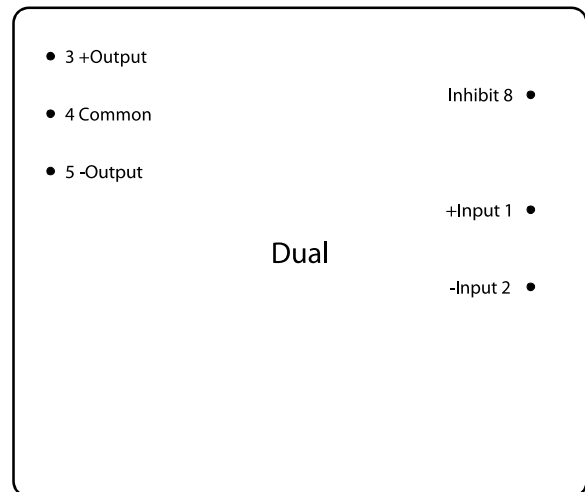

Pinning E3

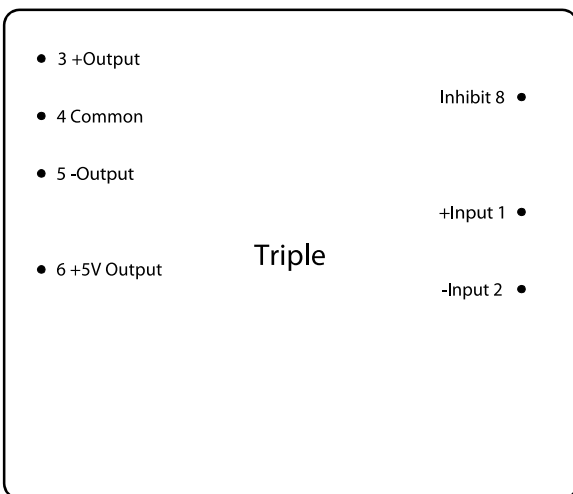

Brick cases, bottom view

Pinning QB1

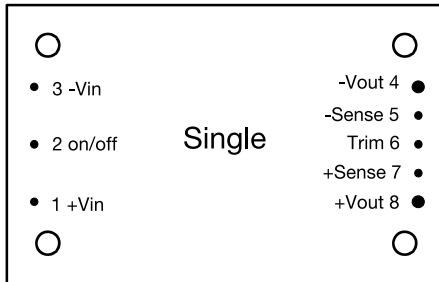

Pinning QB2

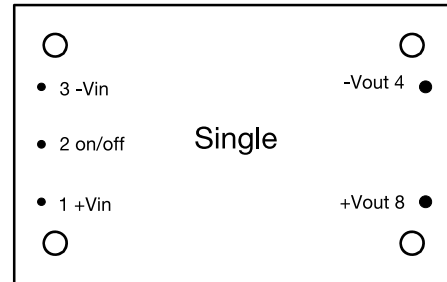

Pinning HB1

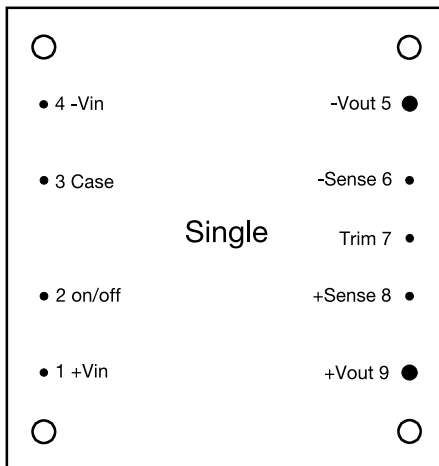

Pinning HB2

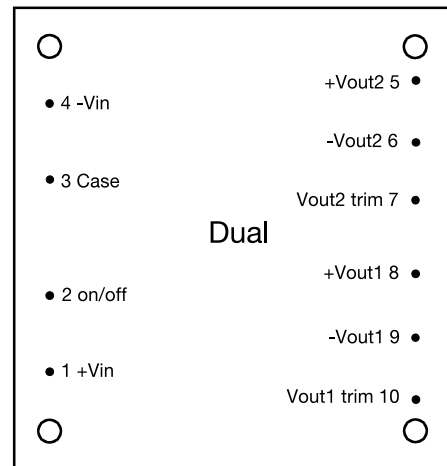

Pinning FB1

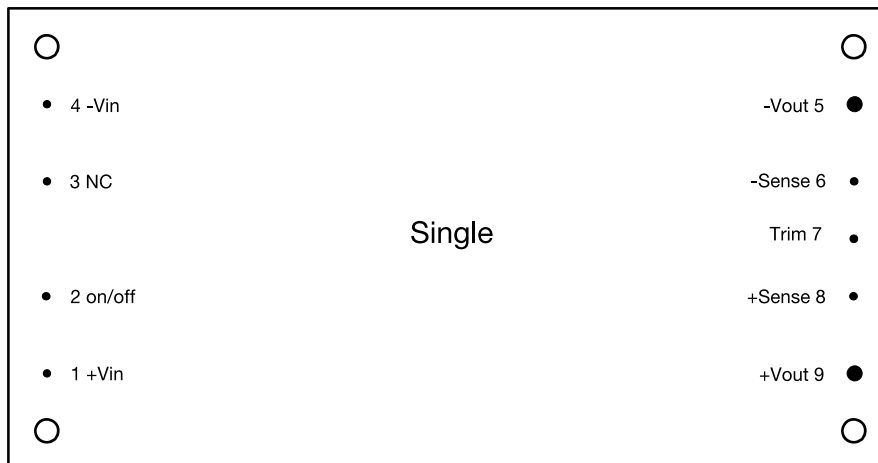

SMD cases, top view

Pinning SMD8

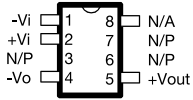

Pinning SMD10

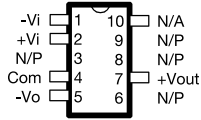

AS cases, top view

Pinning AS1

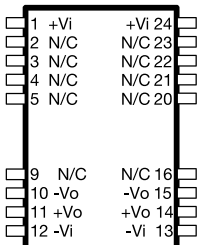

Pinning AS2

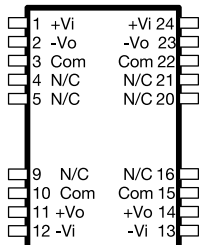

Pinning AS4

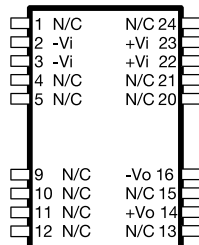

Pinning AS5

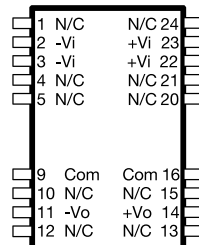

Pinning AS6

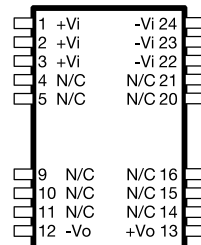

Pinning AS7

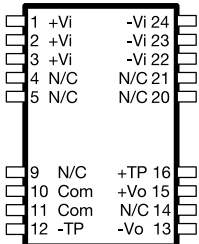

Pinning AS8

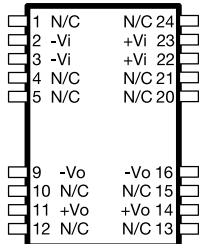

Pinning AS9

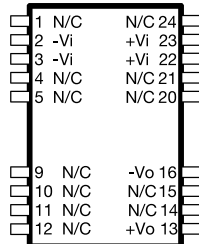

Pinning AS10

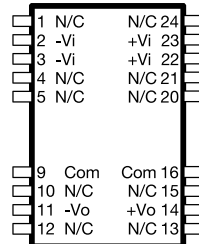

SBS cases, top view

Pinning SBS1

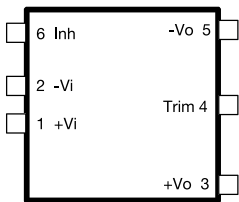

Pinning SBS2

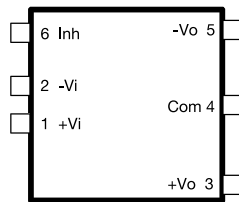

P-SMD cases, bottom view

Pinning P-SMD1

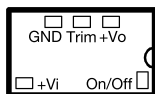

Pinning P-SMD2

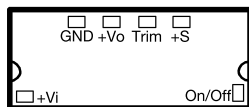

Pinning P-SMD3

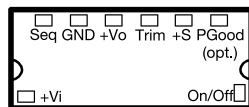

Pinning P-SMD4

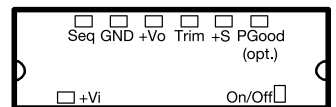

Customized

We put all our energy to work for you

Thanks to our many years of experience, we can be very flexible in addressing individual specific customer requirements. In addition, as a systems supplier, we are also an expert, successful partner when it comes to other product groups (e. g. cable assemblies).

Our versatility can be readily seen in our reference projects in the automotive, industrial, medical, cable TV, building security and railway vehicle sectors as well as projects for end consumers. Maximum reliability during long-term continuous operation and a high level of efficiency are developments which are decisive in customer-specific solutions. Our manufacturing facilities in Europe and the Far East along with international partnerships ensure an optimal cost/benefit ratio.

For example, when addressing individual, technical and economical aspects, we create long-term solutions for our customers. Further, we achieve maximum satisfaction through our expert, flexible and prompt solutions in the service and support areas.

YOUR BENEFITS AS OUR CUSTOMER

Comprehensive

Tailor-made product offer:

Tailor-made power-supply products are developed and manufactured according to customer specifications in a collaborative partnership. Our own R&D department implements innovative concepts. Together, we offer the best performance in these areas:

- OEMs (original equipment manufacturers)
- Individual adaptations based on standard products
- Designs and layouts
- Prototypes
- Pilot production
- Series production

Experienced

Our experienced development department makes certain that you get exactly the power supply you need. Further, our state-of-the-art production facilities guarantee the highest level of quality, even for small to mid-sized customer-specific manufacturing runs. For OEMs, we are your partner where you as the customer define the specifications. In every case, you receive a solution tailored perfectly to your requirements:

- A solution which exactly matches your electrical and mechanical application
- Observance of all required national and international standards
- High quality and reliability
- Excellent price/performance ratio

Versatile

OEMs are active in many sectors:

automotive, industry, medicine, security, defence, cable TV, building security, railway vehicles as well as projects for end consumers.

Certified

Our company is certified to DIN EN ISO9001:2008.

Further, our production is approved by the

"VdS: Inspected. Approved. Safe." independent testing institute.



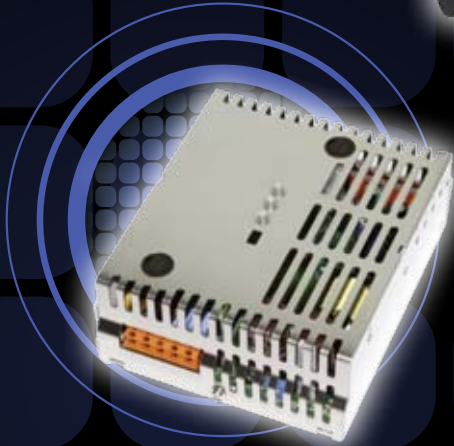

Cabling

Tailor-made cable assemblies – everything for PCBs

With CAC Fabrimex GmbH (a 100 % subsidiary of Fabrimex AG), which has its headquarters in Gerstetten (Baden-Württemberg, Germany), we act as a service provider for cable assemblies in small and mid-sized volumes. At our facility, manufacturing is based on high-quality tools along with fully and semiautomatic machines to produce innovative, cost-effective and reliable solutions. All cables are tested 100 % electrically, upon request even with a high-voltage test to 1000V. Of course, we also have our own microsectioning equipment.

Our employees' expertise and willingness to fully satisfy our customers makes it possible to implement customer requirements in the shortest possible time.

YOUR BENEFITS AS OUR CUSTOMER

Comprehensive

Comprehensive product line:

- Single-conductor assemblies from 0.06 to 6.00 mm²
- Pre-assembled round cables, with or without shielding
- Flat and round-to-flat ribbon cable with various pitches
- Data-cable assemblies of 0.635/1.0/1.27 and 2.5 mm
- Cable sets for electronic modules according to customer specifications
- Cable harnesses for various applications
- Datenkabelkonfektionen
- Coaxial cable for medical technology and flow-metering technology

All our products are printed or labelled in a neutral way with our product code so we can guarantee full traceability.

Experienced

We prepare our cables using a variety of technologies:

- Crimp connections
- Insulation-displacement connections
- Infrared soldering
- Press-on connections
- Precision soldering

Supplier independent

We use connectors and cable/wire from all well-known suppliers (e.g. Erni, Huber+Suhner, FCI, FCT, Tyco, JST, Molex, Hirose, Binder, Lemo, Phoenix, 3M, Harting, Pro-vertha, Leoni, Helu, Lapp and Medi-Kabel).

Versatile

Our pre-assembled cables are used in a wide range of areas such as:

- Fire-alarm and medical technology
- Security technology
- Instrumentation and control technology
- Machine construction
- Telecom and data processing

Certified

Our company is certified to DIN EN ISO9001:2008.



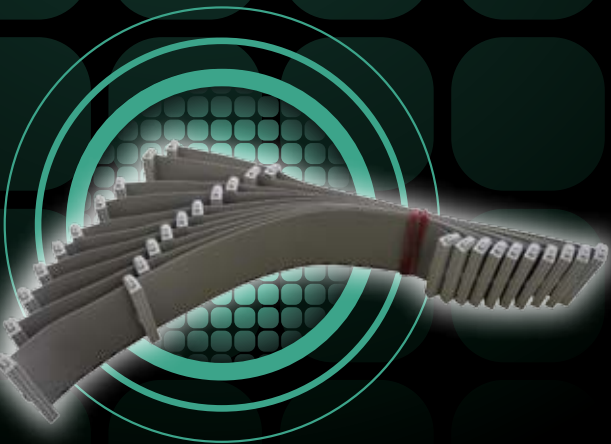
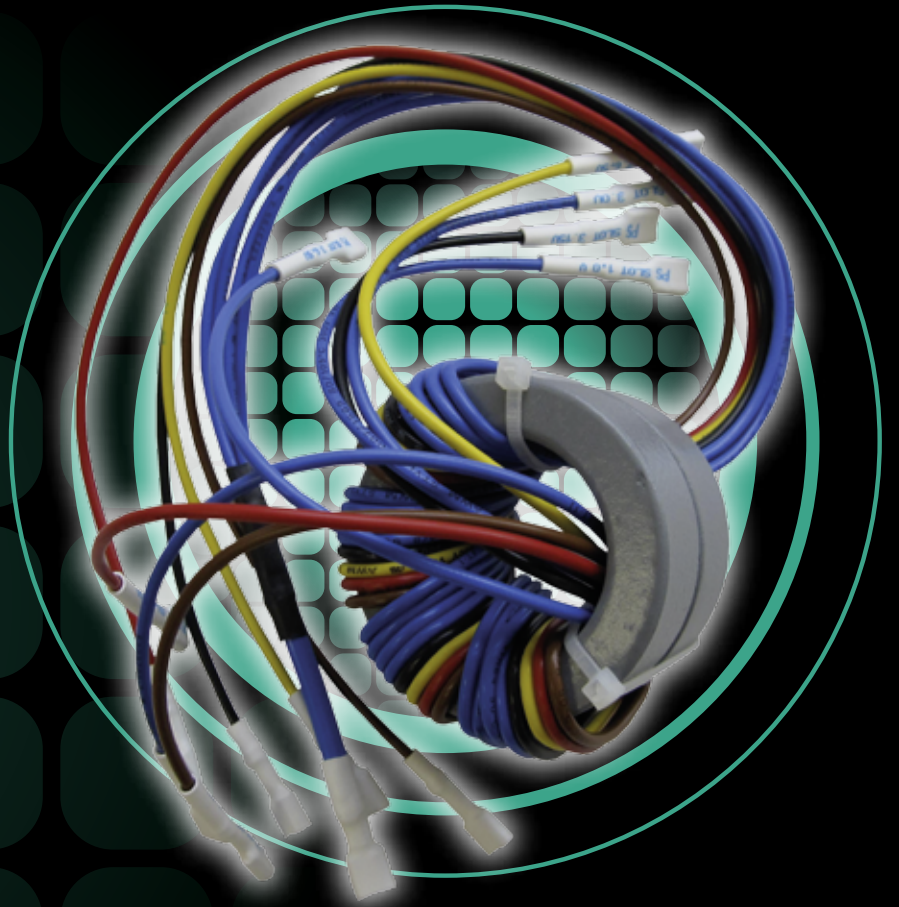

DISTRIBUTOR LIST

HEADQUARTER (INTERNATIONAL)

Fabrimex AG

Techcenterstrasse 2
CH-8608 Bubikon
Switzerland
Tel.: +41 (0)55 253 31 90
Fax: +41 (0)55 253 31 91
info@fabrimex.ch

FABRIMEX GERMANY

CAC Fabrimex GmbH

Karlstrasse 70
DE-89547 Gerstetten
Germany
Tel.: +49 (0)7323 950 0
Fax: +49 (0)7323 950 50
info@cac-fabrimex-ger.de

AUSTRIA

Connex Electronics Vertriebsges.m.b.H.

Knödelhüttenstrasse 66
AT- 1140 Wien
Tel.: +43 (0)1 911 27 47
Fax: +43 (0)1 911 27 47-20
office@connexelectronics.com
www.connexelectronics.com

UR GmbH

Gewerbestrasse 6
AT- 3304 St. Georgen
am Ybbsfelde
Tel.: +43 (0)7472 666 60-0
Fax: +43 (0)7472 666 60-4
office@urgroup.eu
www.bestselectronics.at

BELGIUM

Eclipse SA

Tourhoutsebaan 511
BE-2110 Wijnegem
Tel.: +32 (0)3 354 51 80
Fax: +32 (0)3 354 51 84
info@eclipse.be
www.eclipse.be

CANADA / USA / MIDDLE- AND SOUTHAMERICA

REICO Inc.

720, Rue Guylaine
Fabreville (Laval),
Quebec (Canada)
Tel.: +1 (0) 450 622 31 93
Fax: +1 (0) 450 622 10 42
kurt_reimann@videotron.ca

DENMARK

Toptronic A/S

Centervej 24
DK – 4180 Soroe
Tel.: +45 (0)49 192 500
Fax: +45 (0)49 194 040
salg@toptronic.dk
www.toptronic.dk

ENGLAND

PowerFactorLtd.

8 Pear Tree Farm Industrial Units
Bicester Road, Marsh Gibbon
Bicester Oxfordshire
GB – OX27 0GB
Tel.: +44 (0)1869 278585
Fax: +44 (0)1869 278989
sales@powerfactor.co.uk
www.powerfactor.co.uk

ESTONIA

Elgerta Electronics Ltd.

Kotzebue st. 8
EE-10412 Tallinn
Tel.: +372 622 88 66/67
Mob. +372 5300 3550
Fax: +372 622 88 60
estonia@elgertagroup.com
www.elgertagroup.com

FINLAND

JMR - Comp Oy

Mataratie 4 C
FI – 01350 Vantaa
Tel.: +358 400 514 494
Fax: +358 987 469 89
jmr-comp@nic.fi
www.beatcom.fi

FRANCE

Dicel Electronics

692, Avenue de la Libération
FR – 38290 La Verpillière
Tel.: +33 (0)4 74 82 72 36
Fax: +33 (0)4 74 82 70 69
lionel.carreras@dicel.fr
www.dicel.fr

UNIREP

73 rue de Louge
FR – 31600 Muret
Tel.: +33 (0)5 62 20 01 25
Fax: +33 (0)5 62 20 00 91
sales@unirep.fr
www.unirep.fr

VP Electronique

Square de la Poterie
FR – 91746 Massy Cedex
Tel.: +33 (0)1 69 20 08 69
Fax: +33 (0)1 69 20 27 58
contact@vpelec.com
www.vpelec.com

DISTRIBUTOR LIST

HUNGARY

Merchants Delight Kft

Szobránc utca 15/B
HU- 1143 Budapest
Tel.: +36 (0)1 314 4225
Fax: +36 (0)1 324 8757
sales@merchantsdelight.hu
www.merchantsdelight.hu

INDIA

EsskayElectronics

74-GF (Market side)
Satya Niketan, Moti Bagh-II
IN-110021 New Delhi
Tel.: +91 11 2467 1398
Fax: +91 11 2467 1399
esskay@esskay-L.com

ISRAEL

Bentronix Ltd

9 Altalef Street
IL-Yehud 56216
Tel.: +972 (0)3 536 60 39
Fax: +972 (0)3 536 57 81
sales@bentronix.co
www.bentronix.co.il

ITALY

Comestero Sistemi S.p.A.

Via Bolzano 1/E
IT - 20871 Vimercate MI
Tel.: +39/039 625 091
Fax: +39/039 667 479
info@comestero.com
www.comestero.it

JAPAN

Trancy Inc.

ICI BUILDING 2F, 1-6-7 SHIBUYA,
SHIBUYA-KU
TOKYO 150-0002, JAPAN
Tel.: +81 3 3486 7211
Fax: +81 3 3486 7214
y.imanari@trancy.com
www.trancy.com

KOREA

JB ELECOM

947-2, Bangbae-Dong, Seocho-Gu
Seoul 137-845, KOREA
Tel.: +82 2 521 2923
Fax: +82 2 521 2924
Mob. +82 10 5146 1061
david@jbelecom.com
www.jbelecom.com

LATVIA

Caro Electronics Ltd. (ElgertaGroup)

Brivibas st. 14,
Riga, LV-1012
Tel.: +371 675 01 005
Fax: +371 675 01 004
Mob. +371 294 90 680
latvia@elgertagroup.com
www.elgertagroup.com

LITHUANIA

Elgerta Ltd.

Visoriu St. 2
Vilnius. LT-08300
Tel.: +370 5 265 26 83/89
Mob. +370 6 980 39 45
Fax: +370 5 265 08 28
lithuania@elgertagroup.com
www.elgertagroup.com

NETHERLANDS

Elipse SA

Tournhoutsebaan 511
BE-2110 Wijnegem
Tel.: 0800 354 77 38
Fax: 0800 354 77 33
info@elipse-power.com
www.elipse.be

POLAND

Astat Sp. z o.o.

ul. Dabrowskiego 441
PL-60-451 Poznan
Tel.: +48 61 848 88 71
Fax: +48 61 848 882 76
info@astat.com.pl
www.astat.com.pl

RUSSIA

Argussoft Company

14, 3rd Cherkizovskaya
107061 Moscow, Russia
Tel.: +7 495 660 2855
Fax: +7 495 660 2855
cmp@argussoft.ru
www.argussoft.ru

SPAIN

Diode España S.A.

Poligono Industrial las Arenas
C/Arroyo de los Prados, 11.
ES-28320 Pinto (Madrid)
Tel.: +34 91 456 8100
Fax: +34 91 358 0607
p.albaladejo@diode.es
www.electronica.diode.es

SWEDEN

TPX Sweden AB

Stora Wäsby
SE- 194 37 Upplands Väsby
Tel.: +46 (0)8 544 702 00
Fax: +46 (0)8 758 97 70
info@tpx.se
www.tpx.se

TAIWAN/FAR EAST

Secu6 Technology Co., Ltd.

1F., No.16, Jinmen St.,
Zhongzheng District
Taipei City 10081, Taiwan (R.O.C.)
Tel.: +886 2 2367 7653
Fax: +886 2 2365 6670
captain@secu6.com.tw
www.secu6.com.tw

FABRIMEX

the company you trust

FABRIMEX AG

Techcenterstrasse 2

CH-8608 Bubikon

P +41 (0)55 253 31 90

F +41 (0)55 253 31 91

info@fabrimex.com

www.fabrimex.com

FABRIMEX AG is a company of the
Werap Group.

