

cebekit



Robotics - Robotique - Robótica

Renewable energy - Énergie renouvelables - Energías renovables

Technology - Technologie - Tecnología

Electronics - Electronique - Electrónica

***Educational
Catalog 04***

Last Novelties

Dernières Nouvelles

Últimas Novedades



C-9900



C-9927



C-9895.2



C-9926



C-1102



C-1101

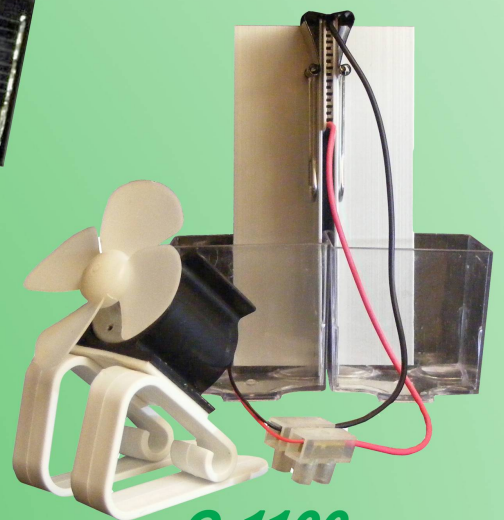

C-1100

cebekit

We are pleased to introduce the new 2014 Educational Catalogue of our Cebekit range.

We have basically incorporated several reusable solar kits, type 3 in 1, 6 in 1 or 14 to 1, that allow several practices with the same kit, this factor is very popular with schools and educational centers as it requires low cost/student & economic investment. Another novelty is the PV case, specially recommended for technological "classes" because it has all the necessary equipment and operating practices in one case. Also note the solar "low-cost" starter kit, and the new experimental kit with Peltier cells.

Cebekit: renewable energy, robotics and technology kits

Os presentamos el nuevo Catálogo Didáctico 2014 de nuestra Gama Cebekit.

Hemos incorporado básicamente varios kits solares re-utilizables, tipo 3 en 1, 6 en 1, o 14 en 1, que permiten hacer varias prácticas con el mismo kit, siendo este factor muy bien valorado por los Centros Educativos, debido a su bajo coste/alumno, y por su económica inversión.

Otra novedad es el maletín fotovoltaico, ideal para las Aulas de Tecnología, al disponer de todo el material agrupado, junto con sus prácticas experimentales en 1 solo maletín.

También resaltar el kit de iniciación solar "low-cost", y el nuevo kit experimental con células Peltier.

Cebekit: Kits de energías renovables, robótica y tecnología.

Voici le nouveau Catalogue Didactique 2014 de notre gamme Cebekit.

Nous avons essentiellement incorporé plusieurs kits solaires réutilisables, type 3 en 1, 6 en 1, ou 14 à 1, qui permettent de réaliser plusieurs pratiques avec le même kit, ce facteur étant très apprécié par les écoles et centres éducatifs car il requiert un faible coût/élève & investissement économique.

Une autre nouveauté est la mallette PV, idéal pour la « salles » technologique car elle dispose de tout le matériel et des pratiques expérimentales nécessaires regroupés dans une seule mallette.

A noter également le kit d'initiation solaire "low-cost", et le nouveau kit expérimental avec des cellules Peltier.

Cebekit: kits d'énergie renouvelables, de robotique et de technologie.

Ours trade-marks

Cebekit - Spain
Thames Kosmos - USA
Cebek - Spain
Power Plus Junior - Holland
Horizon - Singapore
Maxitronic - Taiwan
PICAXE - United Kingdom



Luis Beltran
FADISEL CEO



Reusable educational kits
Kits pédagogiques réutilisables
Kits didácticos reutilizables

+ 10



C-0114
 Solar Kit 6 in 1



C-0111
 Solar Kit 6 in 1 Blue
 Kit solar 6 en 1 azul



C-0117
 Educational Solar Kit 6 in 1
 L'éducation solaire Kit 6 en 1
 Kit educativo solar 6 en 1



C-9921
 14 in 1 Solar Kit Robots



C-0118
 Robots transformers 3 in 1 Solar Kit



C-9924
 7 in 1 Solar Kit Space Fleet

Robot kits

+ 12



C-9897

All Terrain Robot 3 in 1 kit. Reusable. Command included
 Tout Robot terrain 3 en 1 kit. Réutilisables. Commande inclus
 Robot todo terreno en kit 3 en 1. Reutilizable. Mando incluido



C-9894

"Moon Walker". Robot kit with clamps. Command included
 "Moon Walker". Kit Robot avec des pinces. Commande inclus
 "Moon Walker". Robot con pinzas en kit. Mando incluido



YouTube

C-9891

Titan Tank Robot kit. Command included
 Titan Robot Char en kit. commande inclus
 Robot Titan Tank en kit. Mando incluido

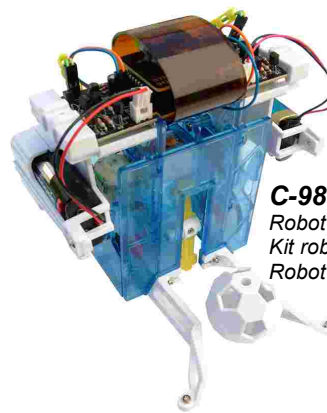

YouTube

C-9893

Robot kit footballer. Ball and Command included
 Kit robot footballeur. Balle et Commande inclus
 Robot futbolista en kit. Pelota y mando incluido



C-9896

USB Interface for Robotic Arm C-9895
 Interface USB pour le bras robotique C-9895
 Interface USB para brazo robótico C-9895



YouTube

C-9895

Robotic Arm in kit. Command included
 Bras robotisé en kit. Commande inclus
 Brazo robótico en kit. Mando incluido



NEW

+ 14

C-9895.2

USB programmable robotic arm. Kit for mounting. Software included
 USB bras robotique programmable. Kit pour le montage. Software inclus
 Brazo robótico programable USB. Kit para montar. Incluye software

Robot Kits

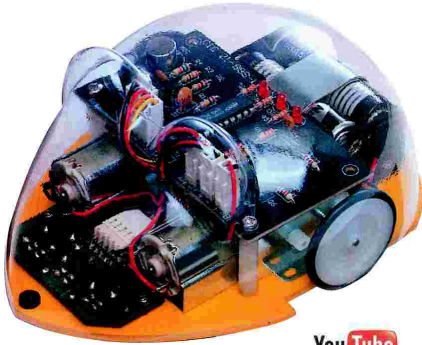

C-9801
Robot line Tracking Mouse kit .

[YouTube](#)

Mark the route with a black tape on the floor so that the robot track it with his eyes.
Marquer la toute avec une bande noire sur le sol de sorte peut le robot peut suivre vec ses yeur .
Marcar con una cinta negra en el suelo el camino , para que el robot la siga con los ojos . Para el montaje necesita soldadura.

+ 12

My first robot Mon premier robot Mi primer robot

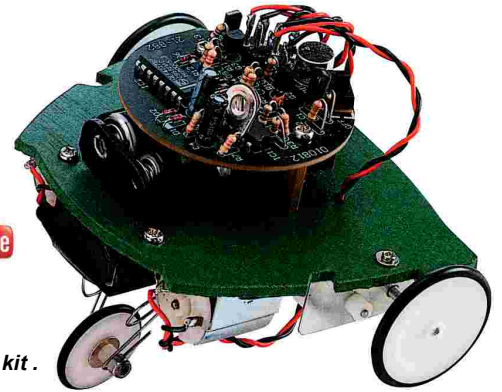

[YouTube](#)

C-9803
Robot Turning frog kit .

This robot is moved by sound. For installation requires welding.
Ce robot est déplacé par son. Pour l'installation nécessite la soudure.
Este kit se mueve por sonido. Para el montaje necesita soldadura.

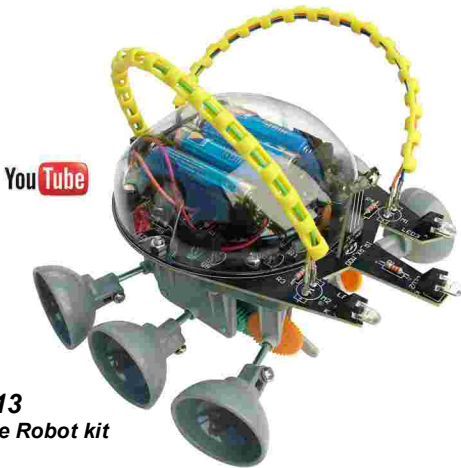

[YouTube](#)

C-9813
Escape Robot kit

Walk with its six legs and uses three infrared sensors to detect obstacles and find your way. For installation requires welding.
Marchez avec ses six pattes et utilise trois capteurs infrarouges pour détecter les obstacles et de trouver votre chemin. Pour l'installation nécessite la soudure.
Camina con sus seis patas y usa sus tres sensores infrarrojos para detectar los obstáculos y encontrar el camino . Para el montaje necesita soldadura.



[YouTube](#)

C-9881
Line follower robot kit.
Chassis included
Kit robot suiveur de ligne. Châssis inclus
Kit Robot seguidor de línea . Chasis Incluido



[YouTube](#)

C-9802
Robot Sound reversing car kit

It moves like a slap noise as an obstacle changes direction. For installation requires welding.
Il se déplace comme un bruit de claque comme un changement de direction obstacles. Pour l'installation nécessite la soudure.
Se mueve por ruido como una palmada y cuando encuentra un obstáculo cambia de sentido . Para el montaje necesita soldadura.

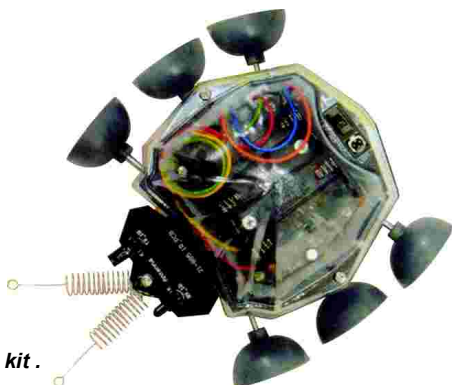

C-9812
Robot Ladybug kit .

It moves with its six legs and uses its infrared eyes to avoid obstacles and find your way. For installation requires welding.
Il se déplace avec ses six pattes et utilise ses yeux infrarouges pour éviter les obstacles et de trouver votre chemin. Pour l'installation nécessite la soudure.
Se mueve con sus seis patas y usa sus ojos mediante infrarrojos para esquivar obstáculos y encontrar el camino . Para el montaje necesita soldadura.

C-9880
Robot follow me. Kit .

It always goes where there is a sound. Chassis included
Il va toujours où il s'agit d'un son.
Châssis inclus .
Se dirige siempre hacia donde haya un sonido. Chasis incluido .



Solar Educational Kits "Low cost"

Kits pédagogiques solaires "Low cost"

Kits Educativos solar "Low cost"



+ 10

C-0117B
 Educational Solar Kit 6 in 1
 L'éducation solaire Kit 6 en 1
 Kit educativo solar 6 en 1

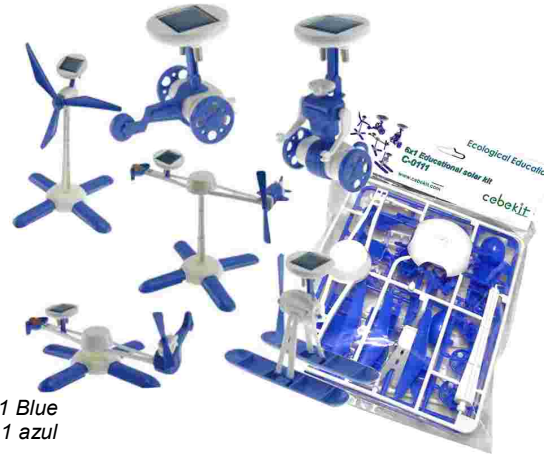

C-0111B
 Solar Kit 6 in 1 Blue
 Kit solar 6 en 1 azul

- Low cost - low price .
- Simple Packaging.
- No paper manual or CD.
- Manual in PDF downloadable from the web.
- Ideal for schools.

- Low cost – prix économique.
- Emballage simple.
- Pas de manuel papier ou CD.
- Manuel en PDF téléchargeable à partir du Web.
- Idéal pour les écoles.

- Low cost - precios económicos .
- Embalaje sencillo .
- Sin manual de papel, ni CD .
- Manual descargable en PDF de la web .
- Ideal para escuelas .

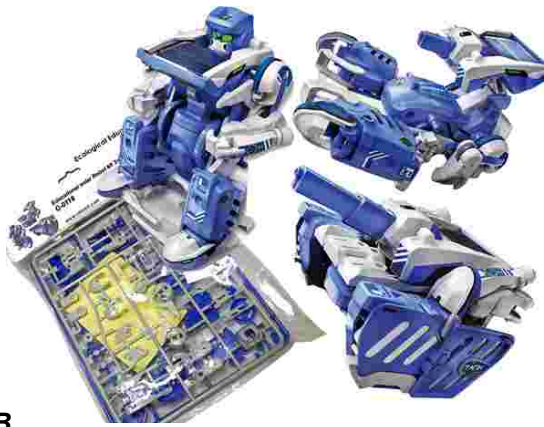

C-0118B
 Robots transformers 3 in 1 Solar Kit

Peltier module experiments

Expériences de module à effet Peltier

Experimentos con módulo Peltier

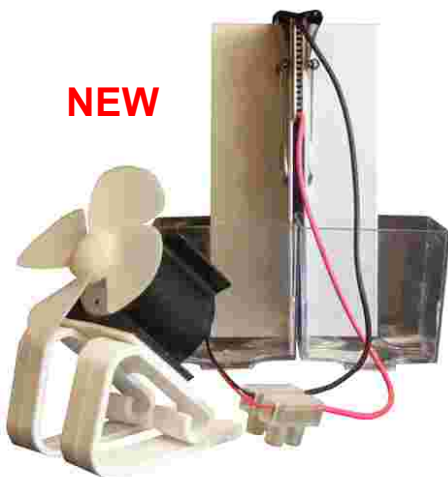

+ 14

C-1100
 Kit educational experiment of the Peltier Thermolectric.
 Du module thermoélectrique à effet Peltier.
 Kit educativo experimentación, efecto termoeléctrico con módulo Peltier.

Educational manual included.

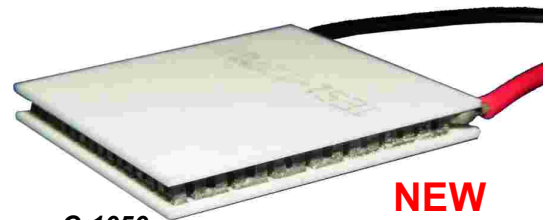

C-1050
 Peltier Module

Thermoelectric Cooler (TEC), for standard applications and educational purposes.
 Module Peltier pour des applications éducatives.
 Módulo Peltier para aplicaciones educativas.
 Size: 30 x 30 x 3,3mm
 I_{max}: 3,5A
 U_{max}: 15,4V
 Q_{max} (ΔT = 0): 27W

Small solar educational kits
Les petits kits éducatifs solaires
Pequeños kits didácticos solares

+ 10



YouTube

C-9969
 Solar Spider kit .
 Araignée kit solaire .
 Kit araña solar .



YouTube

C-9971
 Mini Solar racing car kit
 Mini kit de bolide solaire
 Kit mini bólido solar



YouTube

C-9977
 Solar Seagull kit.
 Kit solaire Mouette.
 Kit gaviota solar .



YouTube

C-9972
 Solar Frog kit.
 Kit de grenouille solaire.
 Kit rana solar .



YouTube

C-9975
 Solar Orangutan kit.
 Kit solaire orang-outan.
 Kit orangután solar .



YouTube

C-9976
 Solar Aerial Tram kit.
 Kit de voiture de câble solaire.
 Kit teleférico solar .

Small solar educational kits
Les petits kits éducatifs solaires
Pequeños kits didácticos solares

+ 10



YouTube

C-9974
 Solar F1 racing car kit.
 Kit de voiture de course F1 solaire.
 Kit coche carreras F1 solar .

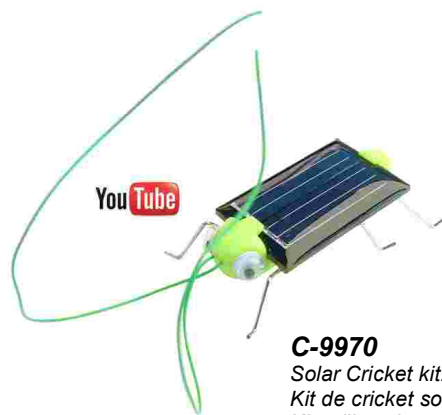

YouTube

C-9970
 Solar Cricket kit.
 Kit de cricket solaire.
 Kit grillo solar .



NEW

C-9926
 Solar Spacecraft kit.



YouTube

C-9973
 Solar Worm Kit.
 Kit solaire ver.
 Kit gusano solar .



NEW

C-9900
 Remote Control RC Solar Car. Mounted. Battery included .
 Designed to be recharged via USB or under sunr, through its sunroof.
 RC Command recharged by USB.

Télécommande RC voiture solaire.Monté. Batterie incluse .
 Conçu pour être rechargée via le port USB ou via solaire, grâce à son toit
 ouvrant. Commande RC rechargée par USB.

Coche solar teledirigido con RC . Se suministra montado. Bateria incluida.
 Diseñado para ser recargado mediante el USB o via solar , gracias a su
 techo solar. Mando RC se recarga por el USB.



NEW

C-9927
 Solar boat in kit
 Bateau solaire en kit
 Barca solar en kit

Educational kits for beginner solar energy

Kits pédagogique pour l'énergie solaire débutant

Kits didácticos para la iniciación a la energía solar

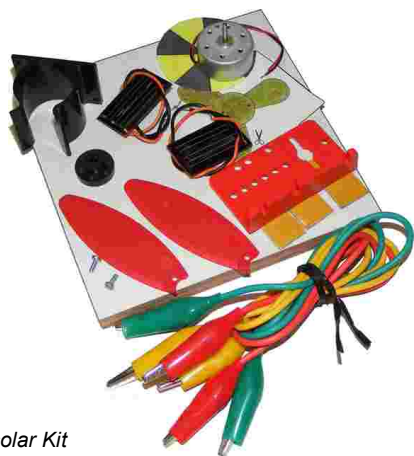

+ 10

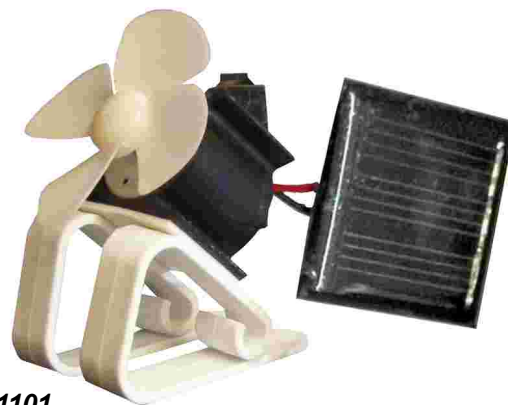

C-0110B
Educational solar Kit

Basic educational solar kit for beginners. Manual included.
Kit solaire éducatif de base pour les débutants. Manuel inclus.
Kit solar educativo básico para principiantes. Manual incluido .

C-1101
Solar kit low-cost

Begginer solar kit. Low-cost.
Kit solaire pour débutants. Prix économique.
Kit solar para principiantes. Precios económicos.



+ 12



C-0115
Solar Energy Lab .

Basic educational solar kit to practice with solar thermal energy. Manual included.
Kit solaire éducatif de base à la pratique avec l'énergie solaire thermique. Manuel inclus.
Kit solar educativo básico para practicar con la energía solar térmica. Manual incluido .

C-0112
Complete Solar educational kit, with detailed instructions for beginners to experiment with solar energy.
Kit éducatif solaire complet, avec d'amples instructions pour les débutants à expérimenter avec l'énergie solaire.
Completo kit didáctico Solar, con un amplio manual de instrucciones para la iniciación a experimentar con la energía solar .

For more information and to download the manuals for the kits, visit our web www.cebekit.com
Pour plus d'informations et pour télécharger les manuels des kits, visitez notre site web www.cebekit.com
Para más información y poder descargarse los manuales de los kits , visite nuestra web www.cebekit.com

Portable laboratory for PV classroom
Laboratoire portable pour la classe solaire
Maletín AULA Solar Fotovoltaica



NEW

C-1102

Full sun pack designed so that the teacher can perform various photovoltaic practices, with a class of 30 students.

Includes all necessary materials, including 2 digital testers with protector, 12 solar cells, 18 brackets for engines and cells, 3 motors, 1 light meter, 9 LEDs of different colors, screws, case classifier, 30 colored wires with clips, propellers 4 blades, electronic module to test with LEDs and melodies, pack of resistors of different values, cut-outs, and 1 CD-ROM with a diverse and complete didactic practices performed by students.

Pack complet de soleil conçu pour un enseignant d'effectuer diverses pratiques photovoltaïque, avec une classe de 30 élèves.

Comprend tout le matériel nécessaire, y compris les deux testeurs numériques avec le protecteur, 12 cellules solaires, 18 stands pour les moteurs et les cellules, 3 moteurs, 1 luxmètre, 9 LED de différentes couleurs, des vis, des cas classificateur, 30 fils de couleur avec des clips, hélices 4 lames, module électronique de tester à LEDs et des mélodies, paquet de résistances de valeurs différentes, découpés, et 1 CD-ROM avec diverses et complètes pratiques didactiques réalisés par les étudiants.

Completo pack solar pensado para que un profesor pueda realizar diversas prácticas de energía fotovoltaica, con toda una clase de 30 alumnos.

Incluye todo el material necesario, como 2 testers digitales con protector, 12 células solares, 18 soportes para los motores y las células, 3 motores, 1 luxómetro, 9 leds de diversos colores, tornillos, estuche clasificador, 30 cables de colores con pinzas, hélices de 4 aspas, módulo electrónico para test con leds y melodías, pack de resistencias de diferentes valores, figuras recortables, y 1 CD-ROM con diversas y completas prácticas didácticas a realizar por los alumnos.

Solar educational kits

Kits solaires éducatifs

Kits didácticos Solares



YouTube

C-9920
Solar Worm kit.
Solaire ver kit.
Kit gusano solar.

+ 12



YouTube

C-9922
Solar Race kit.
Kit de voiture solaire.
Kit coche solar.



C-9966
Solar zodiac type boat kit.
Kit de bateau de type zodiac solaire.
Kit solar barca tipo zodiac .

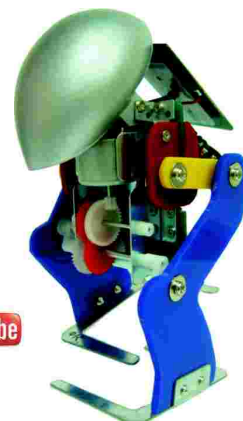

YouTube

C-9925
Solar Astronaut Kit.
Kit d'astronaute solaire.
Kit solar astronauta .



C-9001
Solar Crazy car kit.
Solar cells, motor and manual included .
Kit solaire voiture folle. Comprend moteur,
cellule solaire et instructions de montage.
Kit solar coche loco. Incluye célula solar,
motor y manual.

YouTube



C-9982
Solar Bullet Train Kit.
Kit de Bullet Train solaire.
Kit solar tren bala .



C-9979
Solar system kit. "Turn under the sun".
Kit du système solaire. Tourner sous le soleil.
Kit sistema solar. Gira bajo sol.

+ 10

YouTube

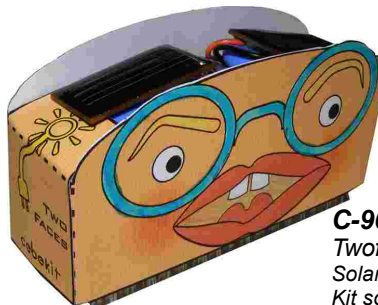

C-9002
Twoface solar kit .
Solar cells, motor and manual included .
Kit solaire 2 faces. Comprend moteur,
cellule solaire et instructions de montage.
Kit solar dos caras. Incluye célula solar,
motor y manual.

For more information and to download the manuals for the kits, visit our web www.cebekit.com
Pour plus d'informations et pour télécharger les manuels des kits, visitez notre site web www.cebekit.com
Para más información y poder descargarse los manuales de los kits , visite nuestra web www.cebekit.com

Dynamo didactic Kits
Dynamo kits didactiques
Kits didácticos a dinamo

+ 10



YouTube

C-9961
 Circuit and F1 racing cars with light and dynamo
 Circuit F1 et les voitures de course avec la lumière et dynamo
 Circuito slot y coches de carreras de F1, con luz y a dinamo

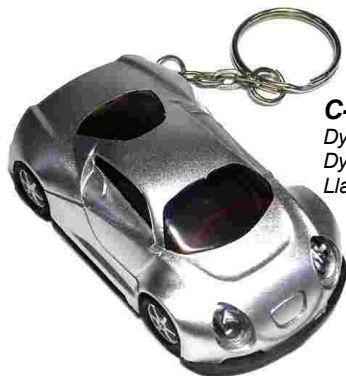

C-0487
 Dynamo flashlight keychain car
 Dynamo lanterne porte-clés voiture
 Llaverro linterna coche a dinamo



C-0488
 Dynamo Flashlight. With three colored markers
 Lanterne une dynamo. Avec trois marqueurs de couleur
 Linterna a dinamo. Con tres rotuladores de colores



C-0486
 Ladybug keychain with light dynamo
 Porte-cléfs Coccinelle avec dynamo lumière
 Llaverro ladybug, con luz a dinamo



YouTube

C-9967
 Solar dynamo Hybrid Vehicle
 Solaire dynamo véhicule hybride
 Vehículo híbrido solar-dinamo

For more information and to download the manuals for the kits, visit our web www.cebekit.com
 Pour plus d'informations et pour télécharger les manuels des kits, visitez notre site web www.cebekit.com
 Para más información y poder descargarse los manuales de los kits, visite nuestra web www.cebekit.com

EDUCATIONAL KITS TO RENEWABLE ENERGY PRACTICES

KITS PÉDAGOGIQUES AUX PRATIQUES ÉNERGIES RENOUVELABLES

KITS EDUCATIVOS PARA HACER PRACTICAS DE ENERGIAS RENOVABLES



C-9991

Power House Green, with 30 experiments and 10 projects
 Power House Green, avec 30 expériences et 10 projets
 Power House Green, con 30 experimentos y 10 proyectos

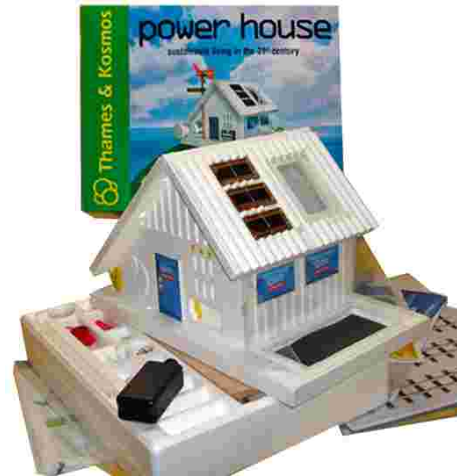

C-9991

Power House, with 70 experiments and 20 projects
 Power House, avec 70 expériences et 20 projets
 Power House, con 70 experimentos y 20 proyectos

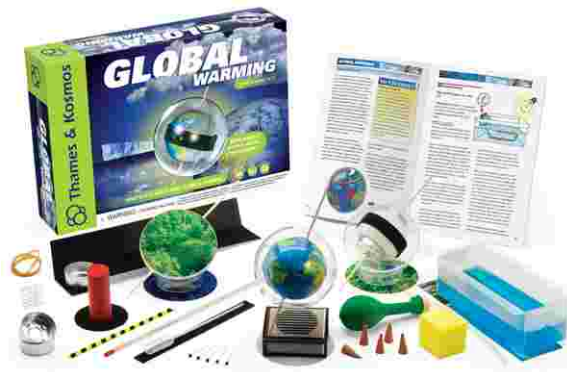

C-9993

Global Warming - Climate and meteorology, with 30 experiments.
 Réchauffement climatique - Climat et météorologie, avec 30 expériences.
 Calentamiento global - Clima y meteorología, con 30 experimentos .

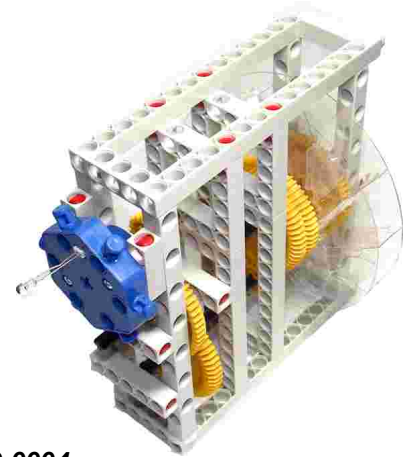

C-9994

Hydropower can be made 30 experiments
 Hydroélectricité peut être faite 30 expériences
 Energía Hidráulica, se pueden hacer 30 experimentos



C-9995

Wind Energy can do 20 experiments.
 L'énergie éolienne peut faire 20 expériences.
 Energía Eólica, se pueden hacer 20 experimentos.

For more information and to download the manuals for the kits, visit our web www.cebekit.com
 Pour plus d'informations et pour télécharger les manuels des kits, visitez notre site web www.cebekit.com
 Para más información y poder descargarse los manuales de los kits , visite nuestra web www.cebekit.com

Wind turbine kit and accessories

Kits d'éoliennes et accessoires

Aerogeneradores en kit y accesorios

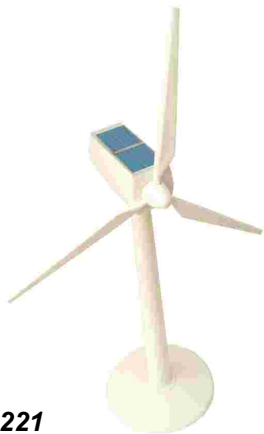

C-0221

ABS plastic kit, height 36 cm.
Kit plastique ABS, hauteur 36 cm.
Kit plástico ABS, altura 36 cm.

C-0221B

ABS plastic kit, height 36 cm.
Kit plastique ABS, hauteur 36 cm.
Kit plástico ABS, altura 36 cm.

YouTube



C-0222

Kit wood, height 36 cm.
Kit en bois, hauteur 36 cm.
Kit en madera, altura 36 cm.



+ 8

C-0209

Wind turbine kit
Kit d'éolienne
Aerogenerador en kit



C-0206

Electronic module to test. Attachment for C-0200.
Module électronique à tester. Pièce jointe C-0200.
Módulo electrónico para test. Accesorio para el C-0200.

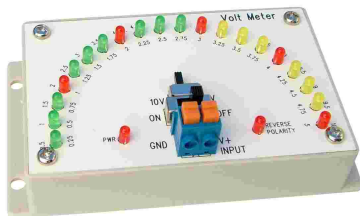
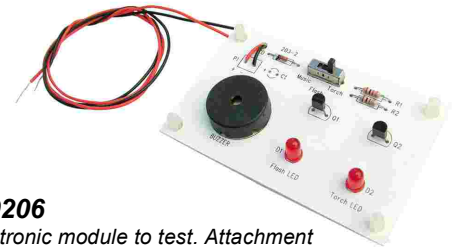

C-0205

LED voltmeter. Attachment for C-0200.
Monted.
Voltmètre LED. Pièce jointe C-0200. Monté.
Voltímetro a LED. Accesorio para el C-0200.
Montado

C-0200

It is a wind turbine specially designed for children to begin to experience and learn the operation of the wind energy. (Wind-lab). Module test included.

Il s'agit d'une éolienne spécialement conçus pour les enfants de commencer à expérimenter et d'apprendre le fonctionnement de l'énergie éolienne. Le module test inclus.

Es un aerogenerador especialmente diseñado para niños, para empezar a experimentar y aprender el funcionamiento de la energía eólica.
Módulo test incluido.

+ 12



C-8423

Ammeter.
Ampèremètre.
Amperímetro.



C-8422

Voltmeter.
Voltmètre.
Voltímetro.



C-7117

Wind turbine to experiment with musical and LED voltmeter circuit with its own energy.
Éolienne à expérimenter avec circuit musical et LED voltmètre avec sa propre énergie.
Aerogenerador que permite experimentar con voltmetro de led y circuito músical con su propia energía.



Educational Kits with salt water, fuel cell and hydrogen

Kits pédagogiques avec les piles à combustible, de l'eau salée et de l'hydrogène

Kits didácticos con célula combustible, de agua salada e hidrógeno



YouTube

C-7106

Spider in fuel cell kit salt water.
Araignée dans kit pile à combustible eau salée.
Araña en kit con célula combustible de agua salada .

+ 10



YouTube

C-7104

Microcar in fuel cell kit salt water.
Microvoiture en kit pile à combustible eau salée.
Microcoche en kit con célula combustible de agua salada .



YouTube

C-7105

Offroad car kit with salt water fuel cell.
Kit voiture offroad avec, pile à combustible eau salée.
Todo terreno en kit con célula combustible de agua salada .



C-7114

Bio Energy discovery kit – ETANOL .
Solar panel + PEM included .

+ 14

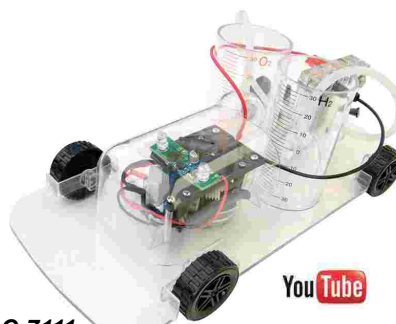

YouTube

C-7111

Fuel Cell Car Science kit .
Solar panel + PEM included .



C-7104SP

5 sheets of magnesium Pack .
5 feuilles de Pack de magnésium .
Pack 5 hojas de magnesio .

C-7121

Reversible fuel cell (P.E.M.)
Pile à combustible réversible
Célula de combustible reversible



YouTube

C-7110

Hydrocar. Educational kit fuel cell.
Solar panel + PEM included .



YouTube

C-7112

Solar hydrogen educational kit.
Solar panel + PEM included .

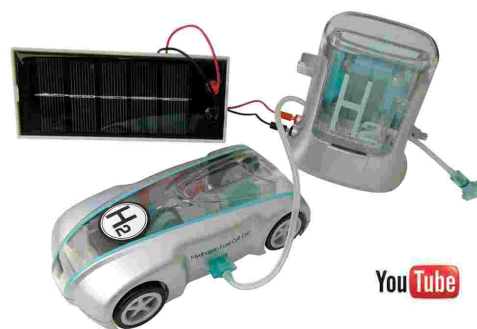

YouTube

C-7113

H-Racer hidro Station kit.
Solar panel + PEM included .

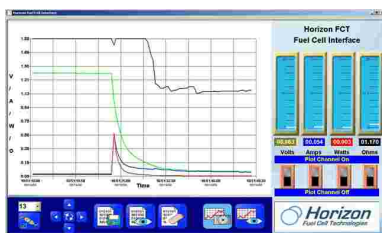

C-7120

Fuell cell software adaptor - interface

Trainers for the practices of electronics
Trainers pour les pratiques de l'électronique
Entrenadores para la prácticas de la electronica



MX-902B
 Electric bell kit.
 Sonnerie électrique kit.
 Kit timbre eléctrico .



MX-902G
 Electricity generator kit.
 Générateur d'électricité kit.
 Kit generador de electricidad .



MX-902L
 Mini tester kit with push button, battery holder and two lamps.
 Kit de test Mini avec bouton-poussoir, le support de batterie et deux lampes.
 Mini tester en kit con pulsador, portapilas y dos lámparas .



MX-801E
 Junior electronics, 5 practices .
 Junior electronics, 5 pratiques .
 Junior electronics, 5 prácticas .



MX-902M
 DC motor and battery kit
 Moteur DC et une batterie kit
 Kit motor CC y portapilas .



MX-803
 Trainer with 20 practices "Sensor Robot" .
 Formateur avec 20 pratiques "Sensor Robot" .
 Entrenador con 20 prácticas "Sensor Robot" .

+ 10



MX-802
 Trainer with 10 practices .
 Formateur avec 10 pratiques .
 Entrenador con 10 prácticas .

+ 12



MX-903
 Trainer with 30 practices .
 Formateur avec 30 pratiques .
 Entrenador con 30 prácticas .



MX-906
 Trainer with 130 practices .
 Formateur avec 130 pratiques .
 Entrenador con 130 prácticas .



MX-908
 Trainer with 300 practices .
 Formateur avec 300 pratiques .
 Entrenador con 300 prácticas .

+ 14

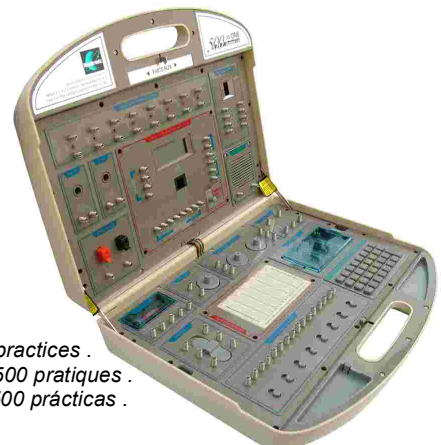

MX-909
 Trainer with 500 practices .
 Formateur avec 500 pratiques .
 Entrenador con 500 prácticas .

For more information and to download the manuals for the kits, visit our web www.cebekit.com

Pour plus d'informations et pour télécharger les manuels des kits, visitez notre site web www.cebekit.com

Para más información y poder descargarse los manuales de los kits , visite nuestra web www.cebekit.com

Kits educational various
Kits pédagogiques plusieurs
Kits didácticos varios

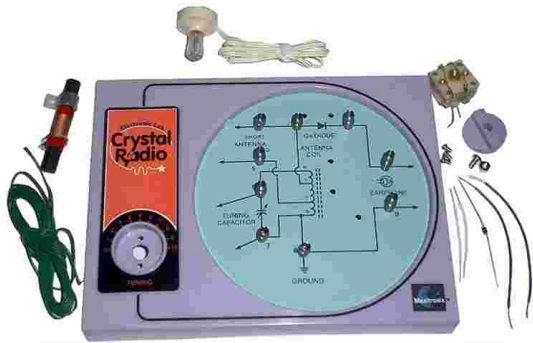

MX-901
 Crystal Radio Kit AM.

+ 10



MX-801C
 Crystal Radio Kit AM .
 Your first radio .
 Votre première radio .
 Tu primera radio .



MX-801F
 FM Radio Kit .



C-6054
 Crystal Headphones .
 Casque de cristal .
 Auriculares de cristal .



C-9736
 My first alarm clock in kit .
 Mon premier réveil en kit .
 Mi primer despertador en kit .



C-9481
 Box metal and plastic spacers .
 Entretoises de cas, le métal et le plastique .
 Estuche de distanciadores, de metal y plástico .



C-9361
 Box basic tools .
 Basic boîte à outils .
 Estuche de herramientas básicas .

+ 12



C-9492
 Box M3 screws and nuts .
 Boîte Vis et écrous M3 .
 Estuche de Tornillos y tuercas M3 .

For more information and to download the manuals for the kits, visit our web www.cebekit.com
Pour plus d'informations et pour télécharger les manuels des kits, visitez notre site web www.cebekit.com
Para más información y poder descargarse los manuales de los kits , visite nuestra web www.cebekit.com

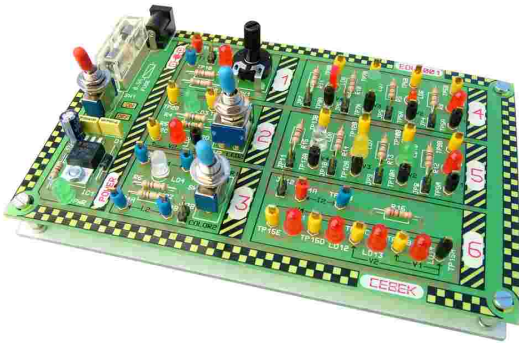

EDU-001 - Leds

Mini-laboratory that is based on the principles of operation and behavior of the diode LED and its variants. 6 practices.

Mini-laboratoire qui est basé sur les principes de fonctionnement et le comportement de la diode LED et ses variantes. 6 pratiques.

Mini-laboratorio que está basado en los principios de funcionamiento y comportamiento del diodo led y sus distintas variantes. 6 prácticas .

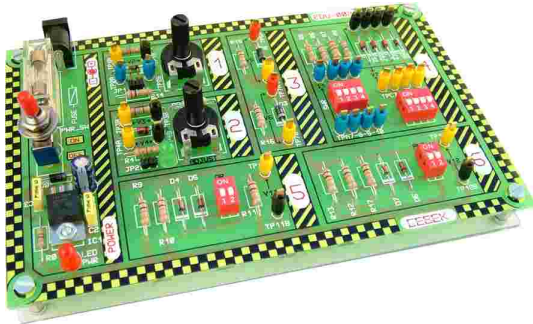

EDU-002 - Diodes and Zener

You can check and compare the principles of zener and diode . 6 practices.

Vous pouvez vérifier et comparer les principes des diodes et zeners . 6 pratiques.

Permite comprobar y contrastar los principios del diodo y del zéner . 6 prácticas .

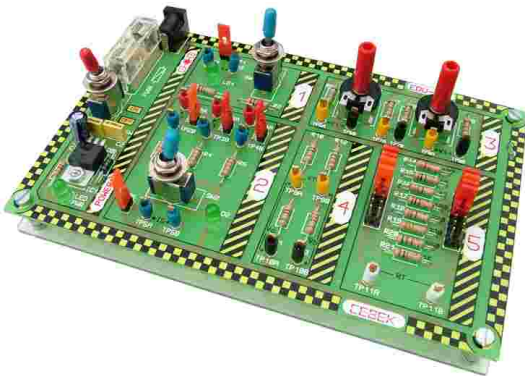

EDU-003 - Resistors - Résistances - Resistencias

Mini-lab to learn the basics of resistors and its application to electronics. 6 Practices.

Mini-laboratoire pour apprendre les rudiments de la résistance et de son application à l'électronique. 6 pratiques.

Mini-laboratorio para aprender los conceptos básicos de la resistencia y su aplicación a la electrónica . 6 prácticas .

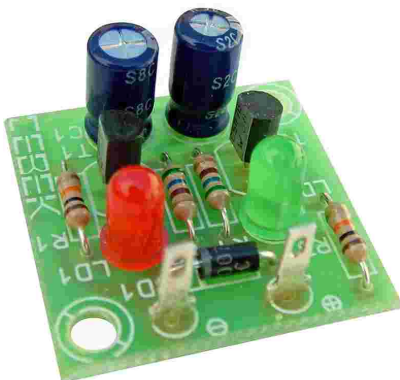

EDU-004 - Solder - Soudure - Soldadura

It has 10 small circuit boards and related components. To learn how to solder in electronics. 3 practices. Ideal for 10 students

Il dispose de 10 petites cartes de circuits imprimés et les composants associés. Pour apprendre à souder en électronique. 3 pratiques. Idéal pour les 10 étudiants .

Tiene 10 pequeños circuitos impresos y los correspondientes componentes. Para aprender a soldar en la electrónica 3 prácticas. Ideal para 10 estudiantes.

Recommended by
ioc institut obert de catalunya

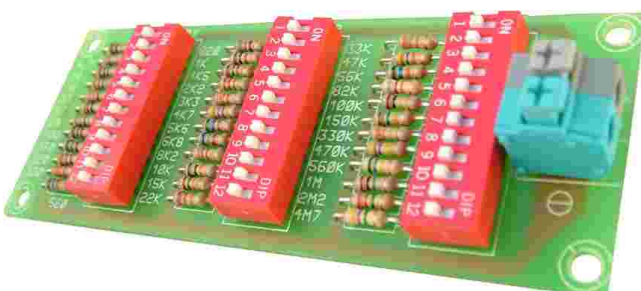

EDU-005 - Resistance box - Boîte de résistance - Caja de resistencias

Resistance box for tests and trials .

Boîte de résistance pour les tests et les essais .

Caja de resistencias para ensayos y pruebas .



EDU-006 - rectifier bridges - ponts redresseurs - Puentes rectificadores

You can check the operation and the different configurations of bridge rectifiers . 4 practices.

Vous pouvez vérifier le fonctionnement et les différentes configurations de ponts redresseurs. 4 pratiques.

Podrá comprobar el funcionamiento y las distintas configuraciones de puentes rectificadores . 4 prácticas .

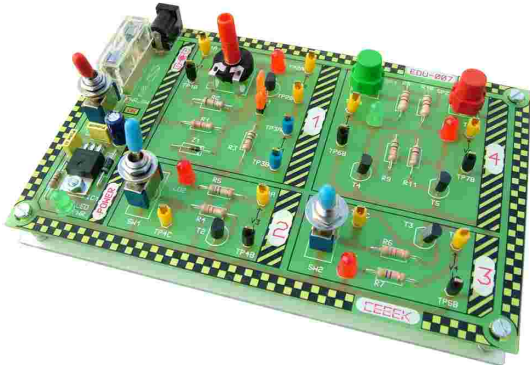

EDU-007 - PNP and NPN transistors

You can see the behavior and operation of the NPN and PNP transistors. 3 practices.

Vous pouvez voir le comportement et le fonctionnement des transistors NPN et PNP. 3 pratiques.

Podrá ver el comportamiento y funcionamiento de los transistores NPN y PNP. 3 prácticas .

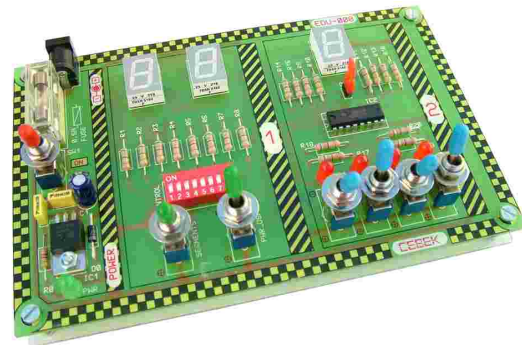

EDU-008 - LED display

You can check the principles of LED display, common anode and cathode. 4 practices.

Vous pouvez vérifier les principes de l'affichage LED, anode et cathode commune. 4 pratiques.

Podrá comprobar los principios del display led de ánodo y cátodo común . 4 prácticas .

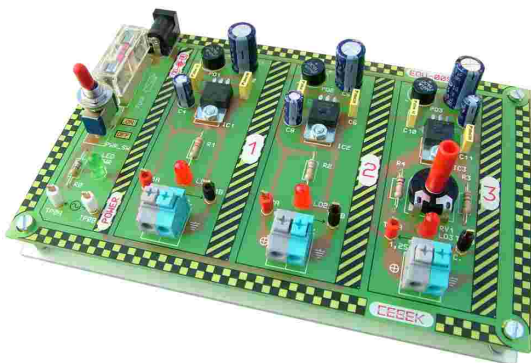

EDU-009 - Power - Alimentations - Fuente de alimentación

Shorting power supply, voltage regulator with fixed output, variable, negative, etc. 5 practices .

Un court-circuit Alimentation, le régulateur de tension avec sortie fixe, variable, négatif, etc. 5 pratiques.

Fuente de alimentación cortocircuitable, regulación de tensión, con salida fija, variable, negativa, etc. 5 prácticas .

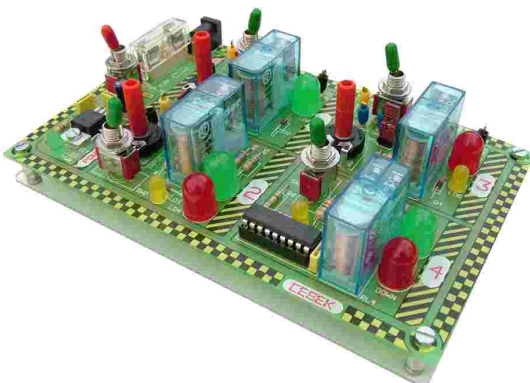

EDU-010 - Electromechanical Relay - Relais électromécanique - Relé electromecánico

Operation and Control Electromechanical relay . 5 practices .

Fonctionnement et Contrôle de relais électromécaniques - 5 pratiques .

Control y funcionamiento de un relé electromecánico. 5 prácticas .

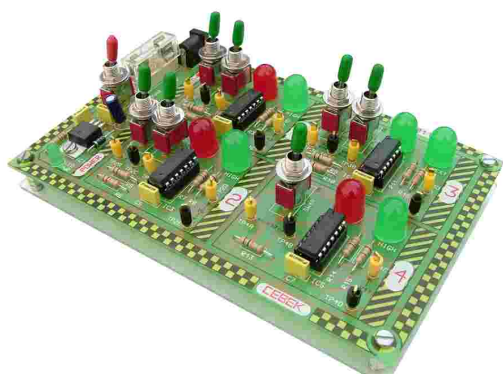

EDU-011 - Integrated Logic Gates - Portes Intégrés logiques - Puertas lógicas integradas

Understand the principle of integrated logic gates, Or, Xor, And, Nor, Nand and Inverters with LED display and readings on circuit. 5 practices.

Comprendre le principe de portes logiques intégrés, OR, XOR, AND, NOR, NAND et Inverters avec affichage LED et lectures sur circuit. 5 pratiques.

Comprende el principio de las puertas lógicas integradas, Or, Xor, And, Nor, Nand e Inversoras, con visualización sobre leds y lecturas en circuito, 5 prácticas.

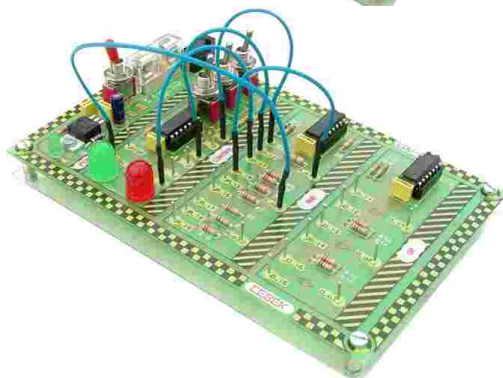

**EDU-012 - Logic gates. Boole algebra axioms, method Karnaugh
Portes logiques. Axiomes de l'algèbre de Boole, méthode Karnaugh
Puertas lógicas. Axiomas de álgebra de boole, metodo de Karnaugh**

From the distribution of different doors with plate wiring connection allows both implementations with different types of doors, more than two inputs. 4 practices.

De la distribution des différentes portes avec connexion de câblage de la plaque permet aux deux implémentations avec différents types de portes, plus de deux entrées. 4 pratiques.

A partir de la distribución de distintas puertas con conexión para cableado en placa, permite realizar implementaciones tanto con los distintos tipos de puertas, de más de dos entradas, 4 prácticas.

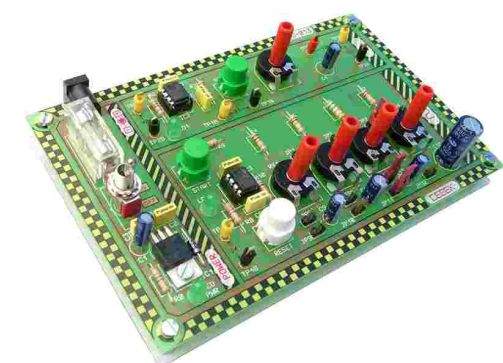

EDU-013 - NE 555 in monostable

How does the NE555 monostable mode. 3 practice.

Comment fonctionne le mode monostable NE555. 3 pratique.

Como funciona del NE555 en modo monoestable. 3 prácticas.

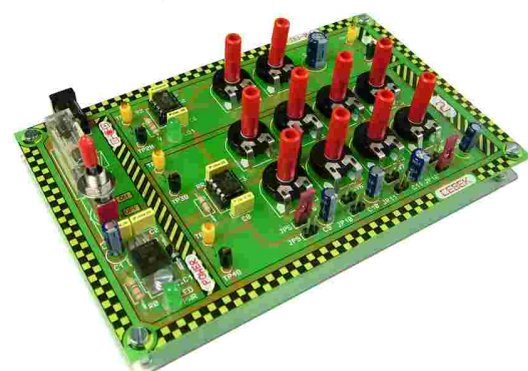

EDU-014 - NE 555 Astable

You can see the performance and response of a free-swinging multivibrator based on the "555", 3 practice.

Vous pouvez voir la performance et la réponse d'une bascule à oscillation libre basé sur le "555", 3 pratique.

Se puede ver el funcionamiento y respuesta de un multivibrador de oscilación libre basado en el "555", 3 prácticas.

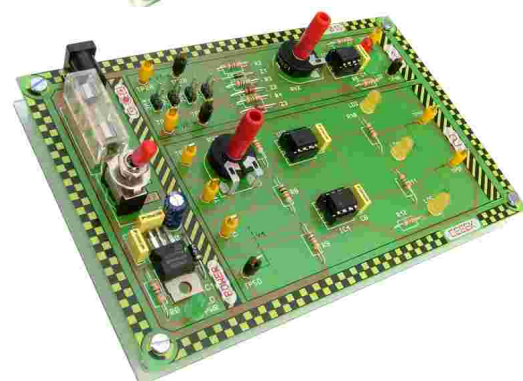

EDU-015 - Comparators with 741

Analyzes two basic configurations in the use of operational amplifiers in nonlinear circuits, 3 practice.

Analyse deux configurations de base dans l'utilisation des amplificateurs opérationnels dans les circuits non linéaires, 3 pratique.

Analiza dos configuraciones básicas en el empleo de amplificadores operacionales en circuitos no lineales, 3 prácticas.

EDU series PICAXE educational modules

Modules EDU série PICAXE éducatifs

Módulos educacionales serie EDU PICAXE

+ 14

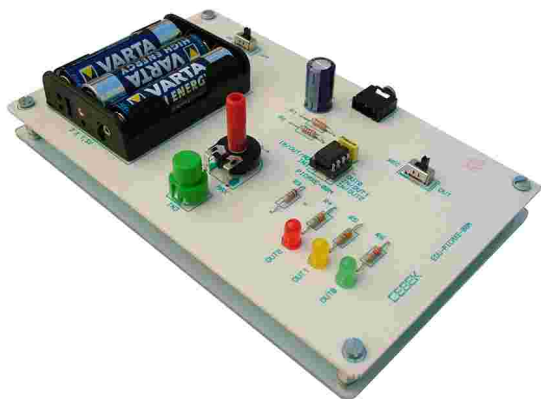

EDU-020 - LED PICAXE

Trainer PICAXE-08M microcontroller to experience control inputs and outputs, with 3 different colored LEDs and a button.

Entraîneur microcontrôleur PICAXE-08M à l'expérience des entrées et sorties de commande, avec 3 LEDs de couleurs différentes et un bouton.

Entrenador microcontrolador Picaxe-08M para experimentar el control de entradas y salidas, con 3 leds de distinto color y un pulsador .

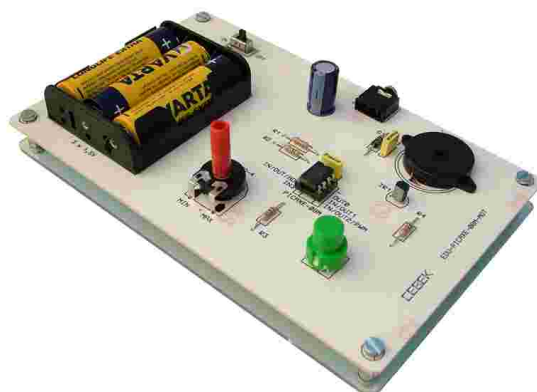

EDU-021 - Buzzer - Vibreur - Zumbador

Trainer PICAXE-08M microcontroller to experience control inputs and outputs, based on the sound level of a buzzer.

Entraîneur microcontrôleur PICAXE-08M à l'expérience des entrées et sorties de commande, en fonction du niveau sonore d'un signal sonore.

Entrenador microcontrolador Picaxe-08M para experimentar el control de entradas y salidas, en base al nivel de sonido de un zumbador.



EDU-022 - Motor

Trainer PICAXE-08M microcontroller to experience the speed setting for the DC motors. based on the PWM regulation.

Entraîneur microcontrôleur PICAXE-08M à l'expérience du réglage de la vitesse pour les moteurs DC. basé sur la régulation PWM.

Entrenador microcontrolador Picaxe-08M para experimentar el ajuste de velocidad de giro para los motores DC. en base a la regulación PWM .



EDU-023 - Light - Léger - Luz

Trainer PICAXE-08M microcontroller to experience the light intensity adjustment based PWM regulation.

Entraîneur microcontrôleur PICAXE-08M à l'expérience du réglage de l'intensité lumineuse en fonction PWM réglementation.

Entrenador microcontrolador Picaxe-08M para experimentar el ajuste de la intensidad luminica en base de la regulación PWM .

For more information and to download the manuals for the kits, visit our web www.cebekit.com

Pour plus d'informations et pour télécharger les manuels des kits, visitez notre site web www.cebekit.com

Para más información y poder descargarse los manuales de los kits , visite nuestra web www.cebekit.com

EDU-PICAXE-USB
USB communication cable



EDU PICAXE MICRO 28 PINS

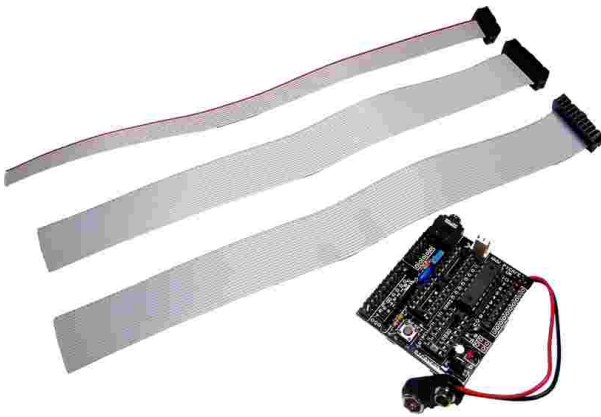

EDU-AXE020 - Board 28

Experimental Board 28-pin PICAXE microcontrollers. **Micro PICAXE NOT INCLUDED.**

Plaque expérimentale 28 broches microcontrôleurs PICAXE. **Micro PICAXE PAS INCLUS.**

Placa experimental para microcontroladores PICAXE de 28 pines. **Micro PICAXE NO INCLUIDO.**



EDU-AXE001U - Complete Pack 28 pins

To experiment with 28 pins PICAXE microcontrollers. All included

Pour expérimenter avec 28 pins PICAXE microcontrôleurs. Tout compris

Para experimentar con microcontroladores PICAXE de 28 pines. Todo incluido.

EDU PICAXE MICRO 18 PINS

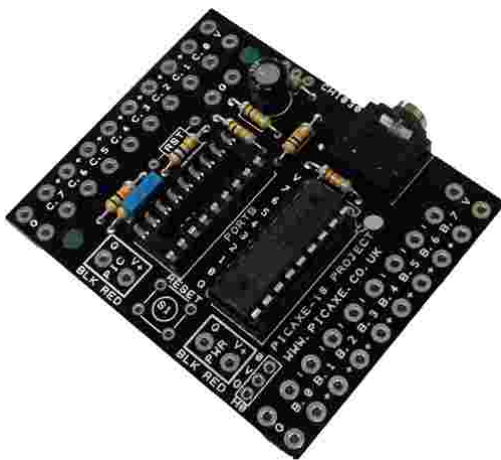

EDU-CHI030 - Board 18

Small board that allows multiple prototypes. **Micro PICAXE NOT INCLUDED.**

Petit maquette qui permet de multiples prototypes. **Micro PICAXE PAS INCLUS.**

Pequeño protoboard que permite hacer múltiples prototipos. **Micro PICAXE NO INCLUIDO.**

+ 14



EDU-AXE002U - Complete Pack 18 pins

To experiment with 18 pins PICAXE microcontrollers. All included.

Pour expérimenter avec 18 pins PICAXE microcontrôleurs. Tout compris

Para experimentar con microcontroladores PICAXE de 18 pines. Todo incluido

For more information and to download the manuals for the kits, visit our web www.cebekit.com
Pour plus d'informations et pour télécharger les manuels des kits, visitez notre site web www.cebekit.com
Para más información y poder descargarse los manuales de los kits, visite nuestra web www.cebekit.com



EDU-CHI035 - Board 18 pins

This microcontroller board 4 buffers. **Micro PICAXE NOT INCLUDED.**

Ce microcontrôleur de maquette dispose de 4 buffers. **Micro PICAXE PAS INCLUS.**

Este protoboard del microcontrolador, dispone de 4 buffers. **Micro PICAXE NO INCLUIDO.**



EDU PICAXE MICRO 8 PINS

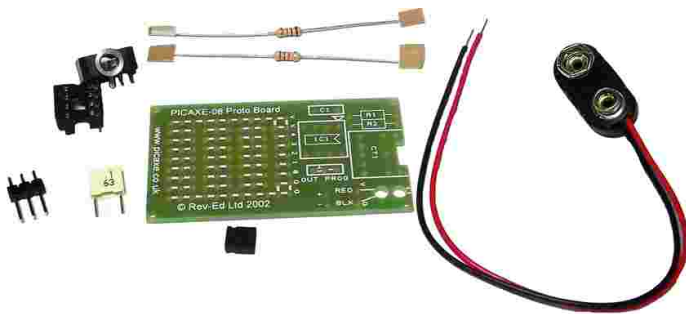

EDU-AXE021 - Board 8 pins

Board for prototyping with the microcontroller. **Micro PICAXE NOT INCLUDED.**

Montage d'essai pour le prototypage avec le microcontrôleur. **Micro PICAXE PAS INCLUS.**

Protoboard para realizar prototipos con el microcontrolador. **Micro PICAXE NO INCLUIDO.**

EDU-AXE003U - Complete Pack 8 pins

To experiment with 8 pins PICAXE microcontrollers. All included.

Pour expérimenter avec 8 pins PICAXE microcontrôleurs. Tout compris

Para experimentar con microcontroladores PICAXE de 8 pins. Todo incluido

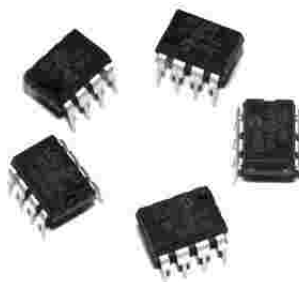
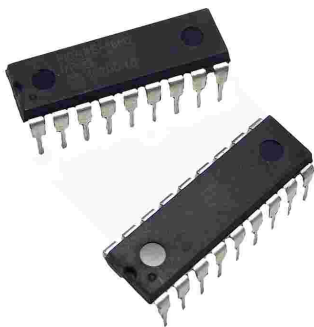

EDU-PICAXE18M2
Micro 18 pins Pack 2 items

EDU-PICAXE08M2
Micro 8 pins Pack 5 items

EDU PICAXE-CD

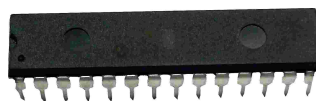

EDU-PICAXE 28X2
Micro Picaxe 28 pins

For more information and to download the manuals for the kits, visit our web www.cebekit.com
 Pour plus d'informations et pour télécharger les manuels des kits, visitez notre site web www.cebekit.com
 Para más información y poder descargarse los manuales de los kits, visite nuestra web www.cebekit.com

Assortment of gears

Assortiment de engrenages

Surtido de engranajes

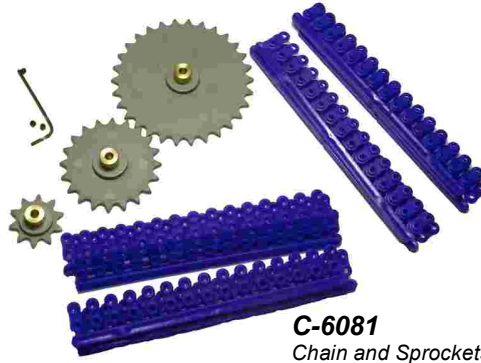

C-6081

Chain and Sprockets - Chaîne et Roues crantées - Cadena y ruedas dentadas

chain links, Maillons de chaîne, Eslabones cadena 180u.
 Gear - Engrenage - Engranaje 10d - Ø 28 mm 1u.
 Gear - Engrenage - Engranaje 20d - Ø 54 mm 1u.
 Gear - Engrenage - Engranaje 30d - Ø 80 mm 1u.
 Allen wrench, clé Allen, Llave allen 1u.



C-6082

Wheels - Roues - Ruedas, axis Ø 3 mm

Wheels - Roues - Ruedas Ø 25 mm 4u.
 Wheels - Roues - Ruedas Ø 37 mm 4u.
 Wheels - Roues - Ruedas Ø 44 mm 4u.
 Wheels - Roues - Ruedas Ø 56 mm 4u.
 Axis - Axe - Eje Ø 3 x 125 mm 8u.



C-6083

Caterpillars - Chenilles - Orugas

big caterpillar - Big chenille - Oruga grande 2u.
 small caterpillar - petite chenille - Oruga pequeña 2u.
 Drive wheels - Roues motrices - Ruedas de tracción 16u.
 Axis - Axe - Eje Ø 3 x 125 mm 4u.



C-6084

Gears flat shaft Ø 3mm - Gears arbre plat Ø 3mm
 Engranajes planos para eje Ø 3mm

Gear - Engrenage - Engranaje 10d 5u.
 Gear - Engrenage - Engranaje 15d 5u.
 Gear - Engrenage - Engranaje 20d 5u.
 Gear - Engrenage - Engranaje 40d 5u.
 Crown - Couronne - Corona 15d 5u.
 Worm screw - Vis sans fin - Tornillo sin fin 2u.
 Axis - Axe - Eje Ø 3 x 125 mm 5u.



C-6085

Gears double flat shaft Ø 3mm - Engrenages à double arbre plat Ø 3mm - Engranajes planos dobles para eje Ø 3mm

Gear - Engrenage - Engranaje 30/10d 5 x 2u.
 Gear - Engrenage - Engranaje 50/10d 5 x 2u.
 Gear - Engrenage - Engranaje 48/10d 5 x 2u.
 Pinion - Pignon - Piñon 10d 5u.
 Axis - Axe - Eje Ø 3 x 125 mm 5u.

Assortment of gears

Assortiment de engrenages

Surtido de engranajes

The bag contains 10 units

Le sac contient 10 unités

La Bolsa contiene 10 unidades



C-6100

Gears 12 teeth – M1 . Allen wrench included .
 Engrenages 12 dents – M1 . Clé Allen incluse.
 Engranajes 12 dientes – M1 . Llave allen incluida .

Gears with brass hub shaft Ø 4mm

Engrenages avec moyeu en laiton arbre Ø 4mm

Engranajes con cubo de latón para eje Ø 4mm

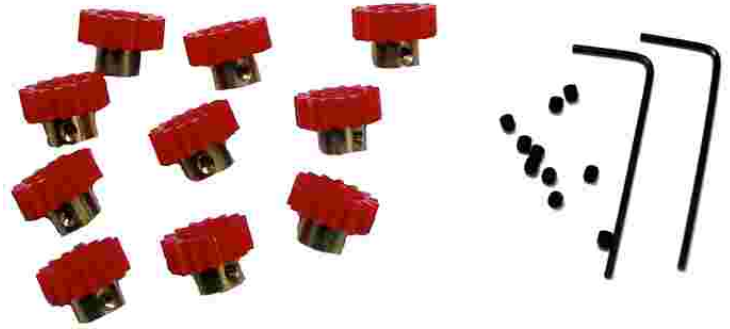

C-6101

Gears 15 teeth – M1 . Allen wrench included .
 Engrenages 15 dents – M1 . Clé Allen incluse.
 Engranajes 15 dientes – M1 . Llave allen incluida .



C-6102

Gears 18 teeth – M1 . Allen wrench included .
 Engrenages 18 dents – M1 . Clé Allen incluse.
 Engranajes 18 dientes – M1 . Llave allen incluida .

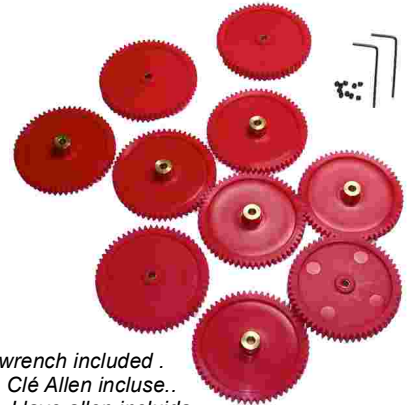

C-6104

Gears 58 teeth – M1 . Allen wrench included .
 Engrenages 58 dents – M1 . Clé Allen incluse.
 Engranajes 58 dientes – M1 . Llave allen incluida .



C-6105

45 ° bevel gears . Allen wrench included .
 Engrenages coniques 45° . Clé Allen incluse.
 Engranajes cónicos 45° . Llave allen incluida .



C-6106

Tires rack 100mm . 10 items
 Pneus en rack 100 mm . 10 articles
 Tires cremallera 100mm . 10 unidades

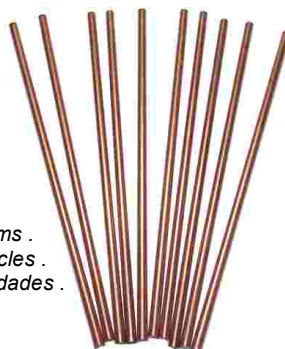

C-6107

Axis Ø 4 x 150mm . 10 items .
 Axe Ø 4 x 150mm . 10 articles .
 Eje Ø 4 x 150mm . 10 unidades .

Assortment of gears

Assortiment de engrenages

Surtido de engranajes

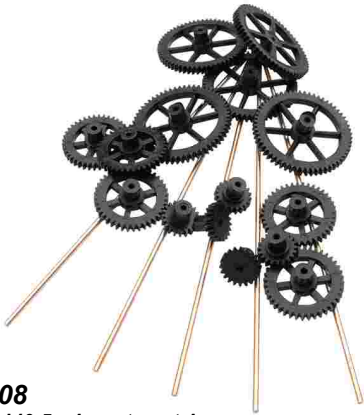

C-6108

Gears M0.5 - Assortment A
Engrenages M0.5 - Assortiment A
Engranajes M0.5 - Surtido A

Gear – Engrenage – Engranaje 20d 5u.
Gear – Engrenage – Engranaje 40d 5u.
Gear – Engrenage – Engranaje 60d 5u.
Axis – Axe – Eje Ø 2 x 150 mm 5u.



C-6110

Gears M0.5 - Assortment C
Engrenages M0.5 - Assortiment C
Engranajes M0.5 - Surtido C

Zipper – Tirettes – Cremalleras 100mm. 5u.
Conical gears - Engrenages coniques 5u.
Engranajes cónicos 45° Ø 12mm
Worm screws / crown - Vis sans fin / Couronne 2u.
Tornillos sin fin / corona (red 34:1)
Axis – Axe – Eje Ø 2 x 150 mm 5u.

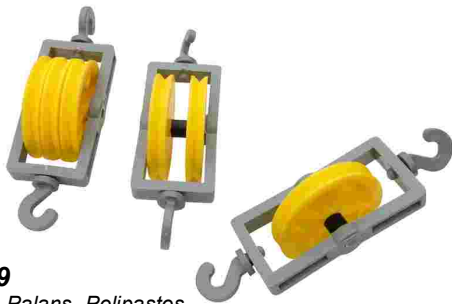

C-6089

Hoists – Palans -Polipastos

Simple 1u.
Double 1u.
Triple 1u.

Polyamide gears for axis Ø 2mm

Engrenages de polyamide pour axe Ø 2 mm

Engranajes de poliamida para eje Ø 2mm

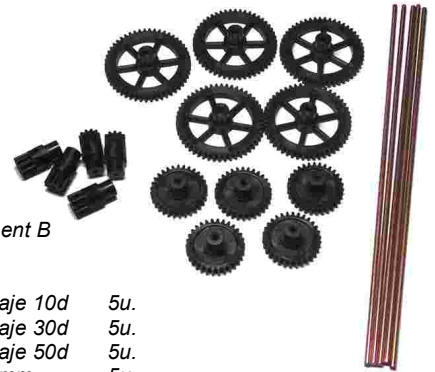

C-6109

Gears M0.5 - Assortment B
Engrenages M0.5 - Assortiment B
Engranajes M0.5 - Surtido B

Gear – Engrenage – Engranaje 10d 5u.
Gear – Engrenage – Engranaje 30d 5u.
Gear – Engrenage – Engranaje 50d 5u.
Axis – Axe – Eje Ø 2 x 150 mm 5u.

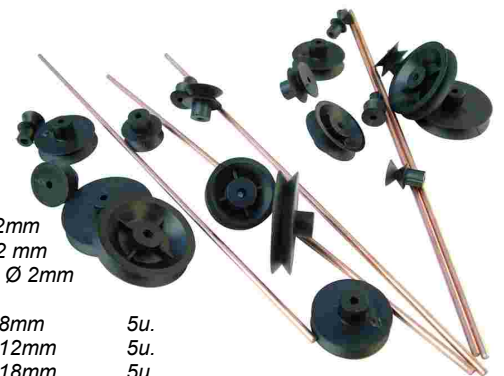

C-6087

Assortment pulley axle Ø 2mm
Assortiment axe poulie Ø 2 mm
Surtido de poleas para eje Ø 2mm

Pulley – Poulie – Polea Ø 8mm 5u.
Pulley – Poulie – Polea Ø 12mm 5u.
Pulley – Poulie – Polea Ø 18mm 5u.
Pulley – Poulie – Polea Ø 25mm 5u.
Axis – Axe – Eje Ø 2 x 150 mm 5u.



C-6088

Assortment pulley axle Ø 4mm
Assortiment axe poulie Ø 4 mm
Surtido de poleas para eje Ø 4mm

Pulley – Poulie – Polea Ø 10mm 3u.
Pulley – Poulie – Polea Ø 20mm 3u.
Pulley – Poulie – Polea Ø 25mm 3u.
Pulley – Poulie – Polea Ø 30mm 3u.
Pulley – Poulie – Polea Ø 40mm 3u.
Axis – Axe – Eje Ø 2 x 150 mm 5u.

Accessories

Accessoires

Accesorios



C-6091

Game 10 colored wires with alligator clips
 Jeu 10 fils de couleur avec des pinces crocodiles
 Juego 10 cables de colores con pinzas cocodrilo

Ideal for schools, workshops and laboratories
 Idéal pour les écoles, les ateliers et les laboratoires
 Ideal para escuelas, talleres y laboratorios



C-6086

Propeller shafts Ø 2mm – Arbres d'hélice Ø 2mm
 Hélices para ejes de Ø 2mm

Ø 150mm Propellers 2 winged - Ø 150mm Hélices 2 ailes - Hélices 2 aspas Ø 150mm	1u.
Ø 115mm Propellers 3 winged - Ø 115mm Hélices 3 ailes - Hélices 3 aspas Ø 115mm	1u.
Ø 57mm Propellers 4 winged - Ø 57mm Hélices 4 ailes - Hélices 4 aspas Ø 57mm	1u.
Ø 60mm Propellers 5 winged - Ø 60mm Hélices 5 ailes - Hélices 5 aspas Ø 60mm	1u.

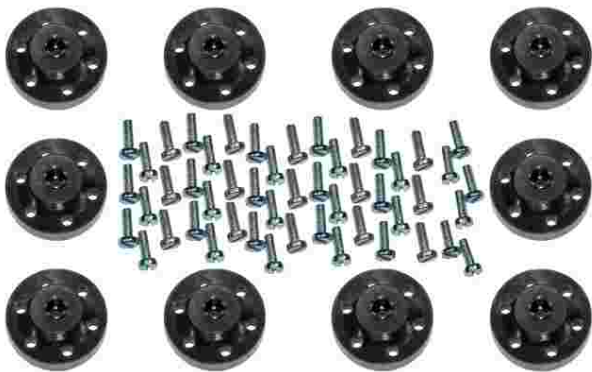

C-6080

Bushings Set and screws - Set douilles et vis - Set bujes y tornillos

Shaft Bushing and Ø3mm Ø2mm.
 Contents: 10 plastic bushings and screws M2 x 5mm 50
 Arbre de la bague et Ø3mm Ø2mm.
 Contenu: 10 douilles et vis plastique M2 x 5 mm 50
 Bujes para ejes Ø2mm y Ø3mm.
 Contenido : 10 bujes de plástico y 50 tornillos M2 x 5mm



C-6039

Pack of 4 universal plastic motor mounts.
 Pack de 4 supports de moteur en plastique universelles.
 Pack de 4 soportes universales de plástico para motores.

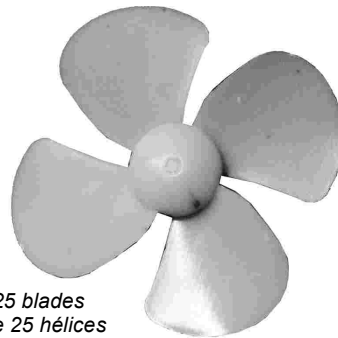

C-6090

4 blade propeller, Ø53 mm. Pack of 25 blades
 4 pales de l'hélice, Ø53 mm. Pack de 25 hélices
 Hélice de 4 palas, Ø53 mm. Pack 25 hélices

Small electric motors

Petits moteurs électriques

Pequeños motores eléctricos



C-6040

Plane Motor - Jusqu'à moteur - Motor plano 3V

Ideal for toys, models and educational Motor.

Pack of 3 units .

Idéal pour les jouets, modèles et moteur de l'éducation. Pack de 3 unités .

Motor ideal para juguetes, modelismo y educativo . Pack de 3 unidades .

Nominal Voltage, Tensión nominal : 3V
 Range work, Travail de range, Rango de trabajo : 1,5-4,5V
 No load speed, Vitesse à vide, Velocidad sin carga : 16300 RPM
 No load current, Pas de courant de charge, Corriente sin carga : 0,38A
 Speed max. efficiency, Vitesse max. efficacité, Velocidad máx. Eficiencia : 12380 RPM
 Current max. Efficiency, courant max. Efficacité, Corriente máx. Eficiencia : 1,2A
 Turning torque g.cm, Torque g.cm, Par de giro g.cm : 10,5
 Output power, Puissance de sortie, Potencia de salida : 1,34W
 Torque limit g.cm, Limite de couple g.cm, Par limite g.cm : 44
 Axle diameter, Diamètre axe, Diámetro eje : 2mm
 Motor rotation, Rotation moteur, Sentido giro : anti-horary, anti-horaire, anti-horario
 Size, Mesures, Medidas : 25x20,1x15,1 mm
 Weight, Poids, Peso : 17 g



C-6044

Motor 6-12V 47W - Moteur 6-12V 47W

Motor Ideal for models, professional, industrial and robotics .

Idéal pour les modèles de moteur, la robotique, professionnels et industriels .

Motor Ideal para maquetas, profesional, industrial, y robótica .

Nominal Voltage, Tensión nominal : 7,2V
 Range work, Travail de range, Rango de trabajo : 6-12V
 No load speed, Vitesse à vide, Velocidad sin carga : 20400 RPM
 No load current, Pas de courant de charge, Corriente sin carga : 1,8A
 Speed max. efficiency, Vitesse max. efficacité, Velocidad máx. Eficiencia : 1950±10% RPM
 Current max. Efficiency, courant max. Efficacité, Corriente máx. Eficiencia : 4,7A
 Turning torque g.cm, Torque g.cm, Par de giro g.cm : 261
 Output power, Puissance de sortie, Potencia de salida : 47W
 Torque limit g.cm, Limite de couple g.cm, Par limite g.cm : 1850
 Axle diameter, Diamètre axe, Diámetro eje : 3,2mm
 Motor rotation, Rotation moteur, Sentido giro : anti-horary, anti-horaire, anti-horario
 Size, Mesures, Medidas : 350xØ 35,8 mm
 Weight, Poids, Peso : 150 g



C-6042

Motor 3V 1,22 W - Moteur 3V 1,22 W

Ideal for modeling and educational . Pack of 3 units .

Idéal pour la modélisation et l'éducation. Pack de 3 unités.

Motor ideal para modelismo y educativo . Pack de 3 unidades

Nominal Voltage, Tensión nominal : 3V
 Range work, Travail de range, Rango de trabajo : 1,5-6V
 No load speed, Vitesse à vide, Velocidad sin carga : 9700 RPM
 No load current, Pas de courant de charge, Corriente sin carga : 0,15A
 Speed max. efficiency, Vitesse max. efficacité, Velocidad máx. Eficiencia : 7930 RPM
 Current max. Efficiency, courant max. Efficacité, Corriente máx. Eficiencia : 0,76A
 Turning torque g.cm, Torque g.cm, Par de giro g.cm : 15
 Output power, Puissance de sortie, Potencia de salida : 1,22W
 Torque limit g.cm, Limite de couple g.cm, Par limite g.cm : 122
 Axle diameter, Diamètre axe, Diámetro eje : 2mm
 Motor rotation, Rotation moteur, Sentido giro : horary, Horaire, Horari
 Size, Mesures, Medidas : 30,5xØ 24 mm
 Weight, Poids, Peso : 42 g

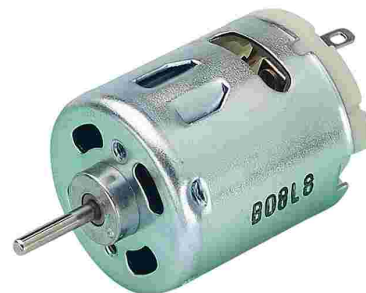

C-6043

Motor 12V 5W - Moteur 12V 5W

Motor Ideal for models and robots

Idéal moteur pour les modèles et les robots

Motor Ideal para maquetas y robots

Nominal Voltage, Tensión nominal : 12V
 Range work, Travail de range, Rango de trabajo : 12-24V
 No load speed, Vitesse à vide, Velocidad sin carga : 13500 RPM
 No load current, Pas de courant de charge, Corriente sin carga : 0,2A
 Speed max. efficiency, Vitesse max. efficacité, Velocidad máx. Eficiencia : 10710 RPM
 Current max. Efficiency, courant max. Efficacité, Corriente máx. Eficiencia : 0,77A
 Turning torque g.cm, Torque g.cm, Par de giro g.cm : 41,3
 Output power, Puissance de sortie, Potencia de salida : 4,54W
 Torque limit g.cm, Limite de couple g.cm, Par limite g.cm : 200
 Axle diameter, Diamètre axe, Diámetro eje : 2,3mm
 Motor rotation, Rotation moteur, Sentido giro : horary, Horaire, Horari
 Size, Mesures, Medidas : 32,5xØ 27,5 mm
 Weight, Poids, Peso : 52 g



C-6045

Three phase brushless generator - Générateur sans balais triphasé - 10V 1W - Generador trifásico sin escobillas .

Ideal for small wind turbines, hydraulic turbines etc., You can get an output of 10VDC-0.A @ 2000rpm.

Idéal pour les petites éoliennes, turbines hydrauliques, etc, vous pouvez obtenir une sortie de 10VDC-0.A @ 2000rpm.

Ideal para pequeños aerogeneradores, turbinas hidráulicas etc., puede obtener una salida de 10VCC-0.A@2000rpm .

Size, Mesures, Medidas : 30x30x18mm

Axis, Axe, Eje : Ø 3mm

Weight, Poids, Peso : 42g

Motors for solar applications

Moteurs pour applications solaires

Motores para aplicaciones solares



C-6058

Micro solar motor - Moteur solaire Micro
Micro motor solar Ø 6mm

Range work, Travail de range, Rango de trabajo : 0,3-1,3V
Axle diameter, Diamètre axe, Diámetro eje : 0,8mm
Sense twist, Sens torsion, Sentido giro : horary, Horaire, Horario
Size, Mesures, Medidas : 15,6xØ 6mm
Weight, Poids, Peso : 2g



C-6059

Micro solar motor - Moteur solaire Micro
Micro motor solar

Nominal Voltage, Tensión nominal : 2V
Range work, Travail de range, Rango de trabajo : 0,3-5,9V
No load speed, Vitesse à vide, Velocidad sin carga : 2200 RPM
No load current, Pas de courant de charge, Corriente sin carga : 0,018A
Speed max. efficiency, Vitesse max. efficacité, Velocidad máx. Eficiencia : 1600 RPM
Current max. Efficiency, courant max. Efficacité, Corriente máx. Eficiencia : 0,055A
Turning torque g.cm, Torque g.cm, Par de giro g.cm : 2,8
Output power, Puissance de sortie, Potencia de salida : 0,057W
Torque limit g.cm, Limite de couple g.cm, Par limite g.cm : 12
Axle diameter, Diamètre axe, Diámetro eje : 2mm
Motor rotation, Rotation moteur, Sentido giro : horary, Horaire, Horario
Size, Mesures, Medidas : 12,3xØ 24,4 mm
Weight, Poids, Peso : 22 g



C-6060

Micro solar motor - Moteur solaire Micro
Micro motor solar

Nominal Voltage, Tensión nominal : 3V
Range work, Travail de range, Rango de trabajo : 1,5-12V
No load speed, Vitesse à vide, Velocidad sin carga : 2700 RPM
No load current, Pas de courant de charge, Corriente sin carga : 0,02A
Speed max. efficiency, Vitesse max. efficacité, Velocidad máx. Eficiencia : 2200 RPM
Current max. Efficiency, courant max. Efficacité, Corriente máx. Eficiencia : 0,07A
Turning torque g.cm, Torque g.cm, Par de giro g.cm : 10
Output power, Puissance de sortie, Potencia de salida : 0,23W
Torque limit g.cm, Limite de couple g.cm, Par limite g.cm : 60
Axle diameter, Diamètre axe, Diámetro eje : 2mm
Motor rotation, Rotation moteur, Sentido giro : horary, Horaire, Horario
Size, Mesures, Medidas : 19,5xØ 32 mm
Weight, Poids, Peso : 45 g

Special motors for solar energy

Moteurs spéciaux pour l'énergie solaire

Motores especiales para energía solar



C-6055

Solar Motor - Moteur solaire - Motor solar

Place the engine above the kit they want to work and hope that this solar cell charged .

Placez le moteur au-dessus du kit ils veulent travailler et nous espérons que cette cellule solaire chargée.

Colocar el motor encima del kit que quieren que funcione y esperar que este cargada la célula solar .



C-6061

Solar motor with reduction - Moteur solaire avec la réduction
Motor solar con reducción

Range work, Travail de range, Rango de trabajo : 0,4-1,3V
Reduction : 9:1 or 27:1
Starting current, Courant de démarrage, Corriente arranque : 25 mA
Velocity, Vitesse, Velocidad : 10-100 rpm
Output axis, Axe sortie, Eje de salida : Ø 2mm
Size, Mesures, Medidas : Ø 38x25 mm



C-6063

Solar motor with reduction - Moteur solaire avec la réduction - Motor solar con reducción

Range work, Travail de range, Rango de trabajo : 0,3-3V
Reduction : 120:1
Starting current, Courant de démarrage, Corriente arranque : 16 mA
Velocity, Vitesse, Velocidad : 12-120 rpm (15 rpm - 0,5V)
Output axis, Axe sortie, Eje de salida : Ø 2mm
Size, Mesures, Medidas : Ø 12x28 mm



C-6050

Solar motor with reduction - Moteur solaire avec la réduction
Motor solar con reducción

Range work, Travail de range, Rango de trabajo : 0,5-4V
Starting current, Courant de démarrage, Corriente arranque : 0,5V - 60 mA
Output axis, Axe sortie, Eje de salida : Ø 2mm
Size, Mesures, Medidas : 31 x Ø 23,9 mm
Motor rotation, Rotation moteur, Sentido giro : horary, Horaire, Horario .

Reduction motor DC

Moteur DC de réduction

Motores reductores CC

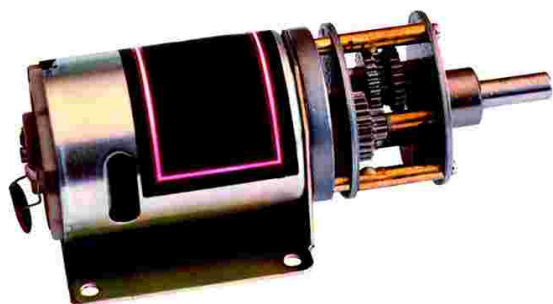

C-6065

Reduction motor. Power media - Réducteur de moteur. Pouvoir des médias - Motor reductor. Media potencia

Alimentation : 1,5 – 3V
 Constant Nominal voltage : 3.0V
 No Load : 0,155A – 9200 rpm
 Max. Efficiency : 7800 rpm – 0,85A – 20g.cm – 1,60W – 62,3%
 Stop torque : 130,0g.cm

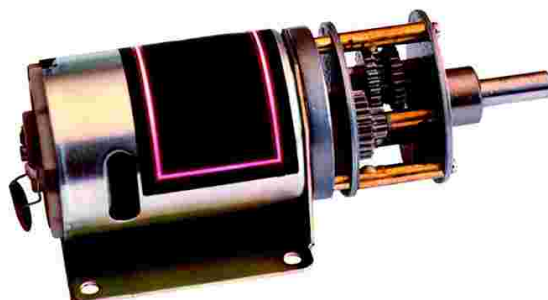

C-6073

Reduction motor. Power media - Réducteur de moteur. Pouvoir des médias - Motor reductor. Media potencia

Alimentation : 12 – 24V
 Constant Nominal voltage : 12V
 No Load : 0,10A – 8400 rpm
 Max. Efficiency : 6300 rpm – 0,30A – 25g.cm – 1,62W – 44,87%
 Stop torque : 100g.cm



C-6066

Reduction motor. High power - Réducteur de moteur. Pouvoir des haut - Motor reductor. Alta potencia

Alimentation : 4,5 – 15V
 Constant Nominal voltage : 12.0VDC
 No Load : 0,52A – 15800 rpm
 Max. Efficiency : 13360 rpm – 2,85A – 154,4g.cm – 21,2W – 61,9%
 Stop torque : 1000g.cm

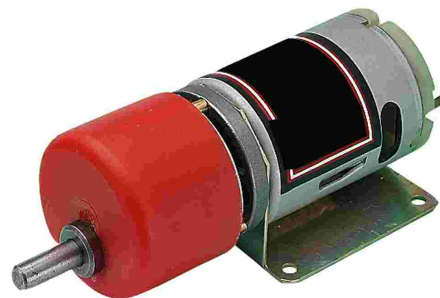

C-6074

Reduction motor. High power - Réducteur de moteur. Pouvoir des haut - Motor reductor. Alta potencia

Alimentation : 4,5 – 15V
 Constant Nominal voltage : 12.0VDC
 No Load : 0,52A – 15800 rpm
 Max. Efficiency : 13360 rpm – 2,85A – 154,4g.cm – 21,2W – 61,9%
 Stop torque : 1000g.cm

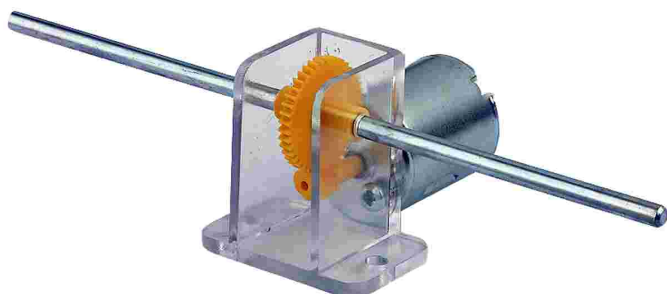

C-6069

Very simple drive system. Fix the base with two wheels, power. Axis 150mm Ø 4mm .

Système d'entraînement très simple. Fixer la base avec deux roues, la puissance. Axe 150mm Ø 4mm .

Sistema motriz muy simple . Fijar a la base con dos tornillos colocar dos ruedas, alimentar . Eje 150mm y Ø 4mm .

For more information and to download the manuals for the kits, visit our web www.cebekit.com
 Pour plus d'informations et pour télécharger les manuels des kits, visitez notre site web www.cebekit.com
 Para más información y poder descargarse los manuales de los kits , visite nuestra web www.cebekit.com

Gear motor kits DC

Kits de moteur réduction DC

Kits de motor reductor CC



C-8050

Gear motor kit – Kit réducteur de moteur – Kit motor reductor

Reduction : 4096:1 – 1,7 rpm @ 12VDC
 Current : 0,03 – 0,2A
 Alimentation : 4 – 12V
 Output axis : Ø 3mm.



C-8051

Gear motor kit – Kit réducteur de moteur – Kit motor reductor

Reductions : 9:1, 15:1, 25:1, 45:1, 125:1, 225:1, 625:1 and 1125:1
 Output axis : Ø 3mm.
 Working Voltage : 1,5 to 4,5V

C-8090

Motive Group 6 legs - Groupe de motrice 6 pattes - Grupo motriz de 6 patas

It is a kit to assemble a double drive unit. It has two engines and transmission reduction to activate six legs that are advanced.

Il s'agit d'un kit à assembler une unité à double motrice. Il dispose de deux moteurs et la réduction de la transmission d'activer six pattes qui sont avancés.

Es un kit para ensamblar un grupo motriz doble. Tiene dos motores con reducción y la transmisión para activar las seis patas que lo hacen avanzar .



Micro reduction motors

Motoréducteurs micro

Micro motores reductores



C-6067

Reduction : 134:1
 Power : 6V
 Nominal torque : 0,078Nm
 Max. Instant : 0,235Nm
 Efficiency : 59 %
 Output axis : Ø 3mm
 Size : 25 x 12 x 10 mm
 Weight : 9,5 g.



C-6068

Reduction : 29:1
 Power : 6V
 Nominal torque : 0,049Nm
 Max. Instant : 0,147Nm
 Efficiency : 73 %
 Output axis : Ø 3mm
 Size : 25 x 12 x 10 mm
 Weight : 9,5 g.



C-6064

Reduction : 60:1
 Power : 0,3 – 4,8V
 Nominal torque : 0,059Nm
 Max. Instant : 0,177Nm
 Efficiency : 66 %
 Output axis : Ø 3mm
 Size : 25 x 12 x 10 mm
 Weight : 9,5 g.

For more information and to download the manuals for the kits, visit our web www.cebekit.com
 Pour plus d'informations et pour télécharger les manuels des kits, visitez notre site web www.cebekit.com
 Para más información y poder descargarse los manuales de los kits, visite nuestra web www.cebekit.com

Solar Cells

Les cellules solaires

Células solares

Solar cells suitable for the initiation and practice to photovoltaics, and educational robotics kits .

Les cellules solaires adaptés pour l'initiation et la pratique de l'énergie photovoltaïque, et des kits de robotique éducatifs .

Células solares indicadas para la iniciación y prácticas a la energía fotovoltaica, los kits educativos y robótica .



C-0120

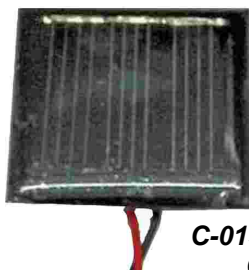

C-0137- C-0138
C-0139



C-0129

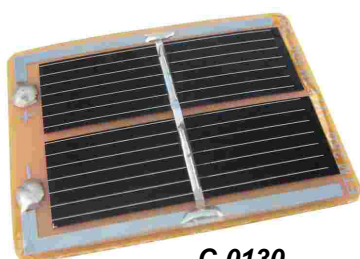

C-0130



C-0133

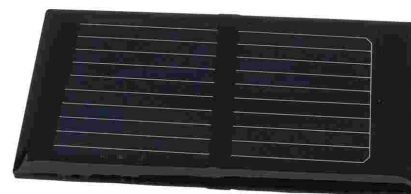

C-0135

Ref.	Power	Voltage Voc	Isc	Sizes	Conection	Lot
C-0120	45 mW	0,45V	100 mA	45x25 mm	Screw	4 units
C-0129	684 mW	1,8V	380 mA	115x60 mm	Screw	1 unit
C-0133	1100 mW	2V	550 mA	137x90 mm	Terminals	1 unit
C-0135	180 mW	0,55V	330 mA	65x34 mm	Screw	1 unit
C-0137	110 mW	1,5V	75 mA	40x40 mm	AWG26 13 cm	4 units
C-0138	150 mW	1,5V	100 mA	40x40 mm	AWG26 13 cm	4 units
C-0139	250 mW	1,5V	170 mA	61x61 mm	AWG26 13 cm	4 units

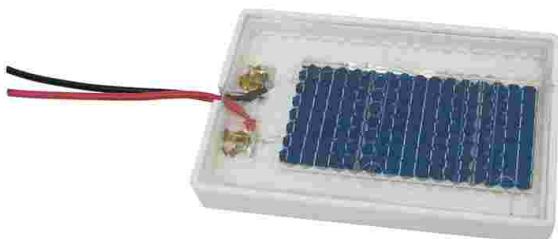

C-0121

Calibrated photovoltaic cell .
Cellule photovoltaïque calibré .
Célula fotovoltaica calibrada .

Nominal value type : 0,5V – 300 mA @ 1000W/m2
size : 35 x 55 x 6 mm
weight : 9 g.

Recommended by



For more information and to download the manuals for the kits, visit our web www.cebekit.com
Pour plus d'informations et pour télécharger les manuels des kits, visitez notre site web www.cebekit.com
Para más información y poder descargarse los manuales de los kits , visite nuestra web www.cebekit.com

INDEX

C-0110B	7	C-6067	29	C-9801	3	EDU-010	17
C-0111	1	C-6068	29	C-9802	3	EDU-011	18
C-0111B	4	C-6069	28	C-9803	3	EDU-012	18
C-0112	7	C-6073	28	C-9812	3	EDU-013	18
C-0114	1	C-6074	28	C-9813	3	EDU-014	18
C-0115	7	C-6080	25	C-9880	3	EDU-015	18
C-0117	1	C-6081	22	C-9881	3	EDU-020	19
C-0117B	4	C-6082	22	C-9891	2	EDU-021	19
C-0118	1	C-6083	22	C-9893	2	EDU-022	19
C-0118B	4	C-6084	22	C-9894	2	EDU-023	19
C-0120	30	C-6085	22	C-9895	2	EDU-AXE001U	20
C-0121	30	C-6086	25	C-9865.2	2	EDU-AXE002U	20
C-0129	30	C-6087	24	C-9896	2	EDU-AXE003U	21
C-0130	30	C-6088	24	C-9897	2	EDU-AXE020	20
C-0133	30	C-6089	24	C-9900	6	EDU-AXE021	21
C-0135	30	C-6090	25	C-9920	9	EDU-CHI030	20
C-0137	30	C-6091	25	C-9921	1	EDU-CHI035	21
C-0138	30	C-6100	23	C-9922	9	EDU-PICAXE08M2	21
C-0139	30	C-6101	23	C-9924	1	EDU-PICACHE18M2	21
C-0200	12	C-6102	23	C-9925	9	EDU-PICACHE-28x2	21
C-0205	12	C-6104	23	C-9926	6	EDU-PICAXEUSB	19
C-0206	12	C-6105	23	C-9927	6	EDUPICAXECD	21
C-0209	12	C-6106	23	C-9961	10	MX-801C	15
C-0221	12	C-6107	23	C-9966	9	MX-801-E	14
C-0221B	12	C-6108	24	C-9967	10	MX-801-F	15
C-0222	12	C-6109	24	C-9969	5	MX-802	14
C-0486	10	C-6110	24	C-9970	6	MX-803	14
C-0487	10	C-7104	13	C-9971	5	MX-901	15
C-0488	10	C-7104SP	13	C-9972	5	MX-902-B	14
C-1050	4	C-7105	13	C-9973	6	MX-902-G	14
C-1100	4	C-7106	13	C-9974	6	MX-902-L	14
C-1101	7	C-7110	13	C-9975	5	MX-902-M	14
C-1102	8	C-7111	13	C-9976	5	MX-903	14
C-6039	25	C-7112	13	C-9977	5	MX-906	14
C-6040	26	C-7113	13	C-9979	9	MX-908	14
C-6042	26	C-7114	13	C-9982	9	MX-909	14
C-6043	26	C-7117	12	C-9990	11		
C-6044	26	C-7120	13	C-9991	11		
C-6045	26	C-7121	13	C-9993	11		
C-6050	27	C-8050	29	C-9994	11		
C-6054	15	C-8051	29	C-9995	11		
C-6055	27	C-8090	29	EDU-001	16		
C-6058	27	C-8422	12	EDU-002	16		
C-6059	27	C-8423	12	EDU-003	16		
C-6060	27	C-9001	9	EDU-004	16		
C-6061	27	C-9002	9	EDU-005	16		
C-6063	27	C-9361	15	EDU-006	17		
C-6064	29	C-9481	15	EDU-007	17		
C-6065	28	C-9492	15	EDU-008	17		
C-6066	28	C-9736	15	EDU-009	17		

 **cebek[®]** **cebekit**  **cebek[®]** **cebekit**

Down load your distributor in our web-site



OPEN YOUR MIND, LEARN WIT US

S.L.

FADISEL

*Quetzal, 19-21 - 08014 Barcelona - Spain
Tel. 34 933 313 342 - Fax 34 934 322 995
www.cebekit.com - info@cebekit.com*

35
YEARS
1979 to 2014

cebekit

DISTRIBUTOR



- Edited by Fadisel.
- All publishing and reproduction rights reserved.
- Text and photos, unless mistake correspond to references described.
- This catalog can be downloaded in PDF format on our website.

- Edité par Fadisel.
- Tous édition et de reproduction droits réservés.
- Texte et photos, sauf erreur correspondent à des références décrites.
- Ce catalogue peut être téléchargé au format PDF sur notre site Web.

- Editado por Fadisel .
- Reservados todos los derechos de edición y reproducción .
- Textos y fotografías, salvo error u omisión corresponden a las referencias descritas .
- Este catálogo se puede descargar en formato PDF en nuestra página web .