

Datasheet
Description

Farran Technology offers Antenna Measurement Extension Modules for extending frequency range of customer systems to 325 GHz

Features

- Coverage 40-325GHz
- High output power
- High dynamic range
- Low weight and compact construction
- Compatible with Agilent antenna measurement systems

Applications

- Near and far field antenna measurement

Accessories

- AC/DC converter with 2m cable
- Manual

Specification (AER-03)	Unit	Min	Typ	Max
RF Frequency In	GHz	220		325
LO Input Frequency	GHz	9.1		13.5
RF Power Input	dBm	5		10
LO Input Power	dBm	5		10
LO Harmonic Number			24	
RF in VSWR			<1.4:1	
RF Port			WR-03	
IF Frequency	MHz	5		1000
LO/IF In Port			SMA(f)	
Input LO Damage Level	dBm		15	
Minimum Detectable Signal	dBm		<100	
DC Supply			12V@0.5A	

Datasheet

Specification (AET-03)	Unit	Min	Typ	Max
RF Frequency Out	GHz	220		325
RF Frequency In	GHz	12.2		18.05
RF Power Out	dBm		-12	
RF Power In	dBm	5		10
LO Harmonic Number			24	
RF Out VSWR			<3.0:1	
RF In VSWR			<1.4:1	
RF Out Port			WR-03	
IF Frequency	MHz	5		1000
LO Input Frequency	GHz	9.1		13.5
RF In Port		SMA(f)		
Input LO Damage Level	dBm	15		
DC Supply		12V@1.5A		

**Antenna Measurement System with Reference Signal
Coupled from Transmit Unit**

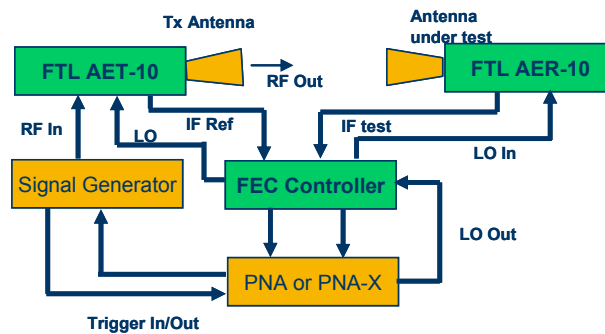

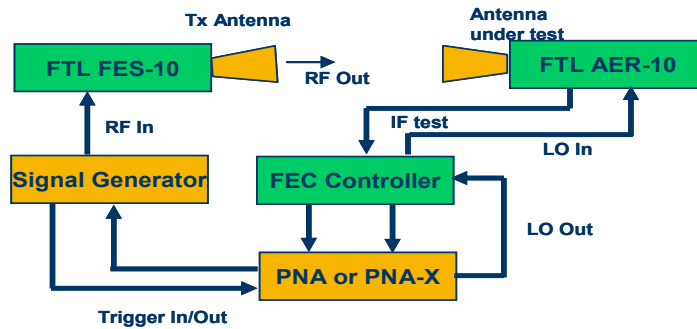
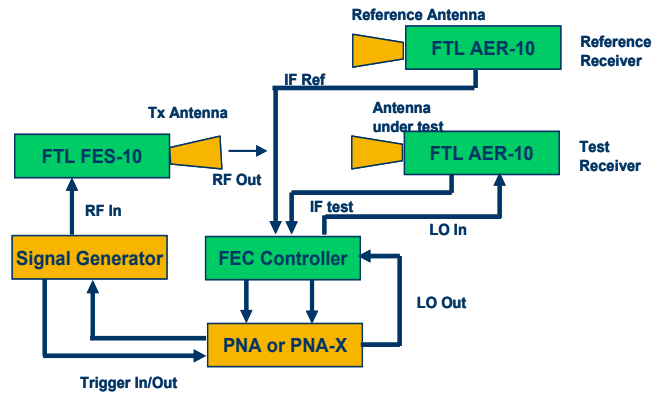
Datasheet
Antenna Measurement System without Reference Signal

Antenna Measurement System with Reference Receiver

Notes:

Farran Technology reserves the right to change, without notice, the characteristic data and other specifications applied to this product. The product may be subject to Irish export restrictions.