



NUMBER <b>GS-20-094</b>	TYPE <b>APPLICATION SPECIFICATION</b>		
TITLE <b>ZipLine™ Connector System</b>		PAGE <b>1 of 23</b>	REVISION <b>B</b>
		AUTHORIZED BY <b>M. Gray</b>	DATE <b>2009-10-05</b>
CLASSIFICATION <b>UNRESTRICTED</b>			

## TABLE OF CONTENTS

<u>Section</u>	<u>page no.</u>
<b>1. OBJECTIVE.....</b>	<b>2</b>
<b>2. SCOPE.....</b>	<b>2</b>
<b>3. APPLICABLE DOCUMENTS.....</b>	<b>3</b>
<b>4. GENERAL CUSTOMER INFORMATION .....</b>	<b>3</b>
4.1. CONNECTOR CONFIGURATIONS .....	3
4.2. HEADER END WALLS .....	4
4.3. SIGNAL CONNECTOR GUIDING FEATURES.....	4
4.4. COMPATIBILITY WITH HARD METRIC PRODUCTS .....	5
4.5. CONTACT WIPE DISTANCE .....	6
4.6. SHORT DETECT PIN OPTION .....	6
4.7. SEPARATE GUIDE MODULES.....	6
4.8. FLEXIBLE SIGNAL IMLA LOADING .....	7
4.9. INTEGRATED POWER IMLA's .....	8
<b>5. RECOMMENDATIONS FOR CUSTOMER PCB LAYOUT .....</b>	<b>9</b>
5.1. DIFFERENTIAL PAIR vs. SINGLE-ENDED LAYOUTS .....	9
5.2. PIN ASSIGNMENTS FOR ORTHOGONAL HEADER FOOTPRINTS .....	9
5.3. PLACING A BACKPANEL HEADER NEXT TO AN ORTHOGONAL HEADER .....	10
5.4. PCB TRACE ROUTING, 1.8 mm column pitch .....	11
5.5. PCB TRACE ROUTING, 3.6 mm column pitch .....	12
5.6. SIGNAL TRACE ROUTING UNDER POWER IMLA'S ON THE DAUGHTER CARD .....	13
5.7. PRINTED CIRCUIT BOARD THICKNESS .....	13
5.8. BACK DRILLING GUIDELINES.....	14
5.9. PCB SCREEN PRINTING RECOMMENDATIONS.....	14
5.10. KEEP-OUT ZONES FOR APPLICATION AND REMOVAL TOOLING:.....	15
<b>6. APPLICATION TOOLING .....</b>	<b>16</b>
6.1. VERTICAL HEADER .....	16
6.2. RIGHT ANGLE RECEPTACLE.....	17
6.3. RIGHT ANGLE HEADER.....	18
<b>7. RECOMMENDED INSERTION FORCES AND SPEED.....</b>	<b>19</b>
<b>8. APPLICATION PROCEDURE .....</b>	<b>19</b>
<b>9. POST-APPLICATION INSPECTION REQUIREMENTS .....</b>	<b>21</b>
<b>10. CONNECTOR REMOVAL TOOLING .....</b>	<b>22</b>
<b>11. REVISION RECORD .....</b>	<b>23</b>

NUMBER <b>GS-20-094</b>	TYPE <b>APPLICATION SPECIFICATION</b>		
TITLE <b>ZipLine™ Connector System</b>		PAGE 2 of 23	REVISION B
		AUTHORIZED BY M. Gray	DATE 2009-10-05
CLASSIFICATION <b>UNRESTRICTED</b>			

## 1. OBJECTIVE

This specification provides information and requirements for customer application of the ZipLine™ press-fit connectors including right angle receptacles and both vertical and right angle headers. It is intended to provide general guidance for process development. It should be recognized that no single process will work under all customer applications and that customers should develop processes to meet individual needs. However, if the processes vary from the recommendations given, FCI cannot guarantee acceptable results.

## 2. SCOPE

This specification provides information and requirements regarding application of ZipLine™ press-fit headers and receptacles to printed circuit boards (PCB's).

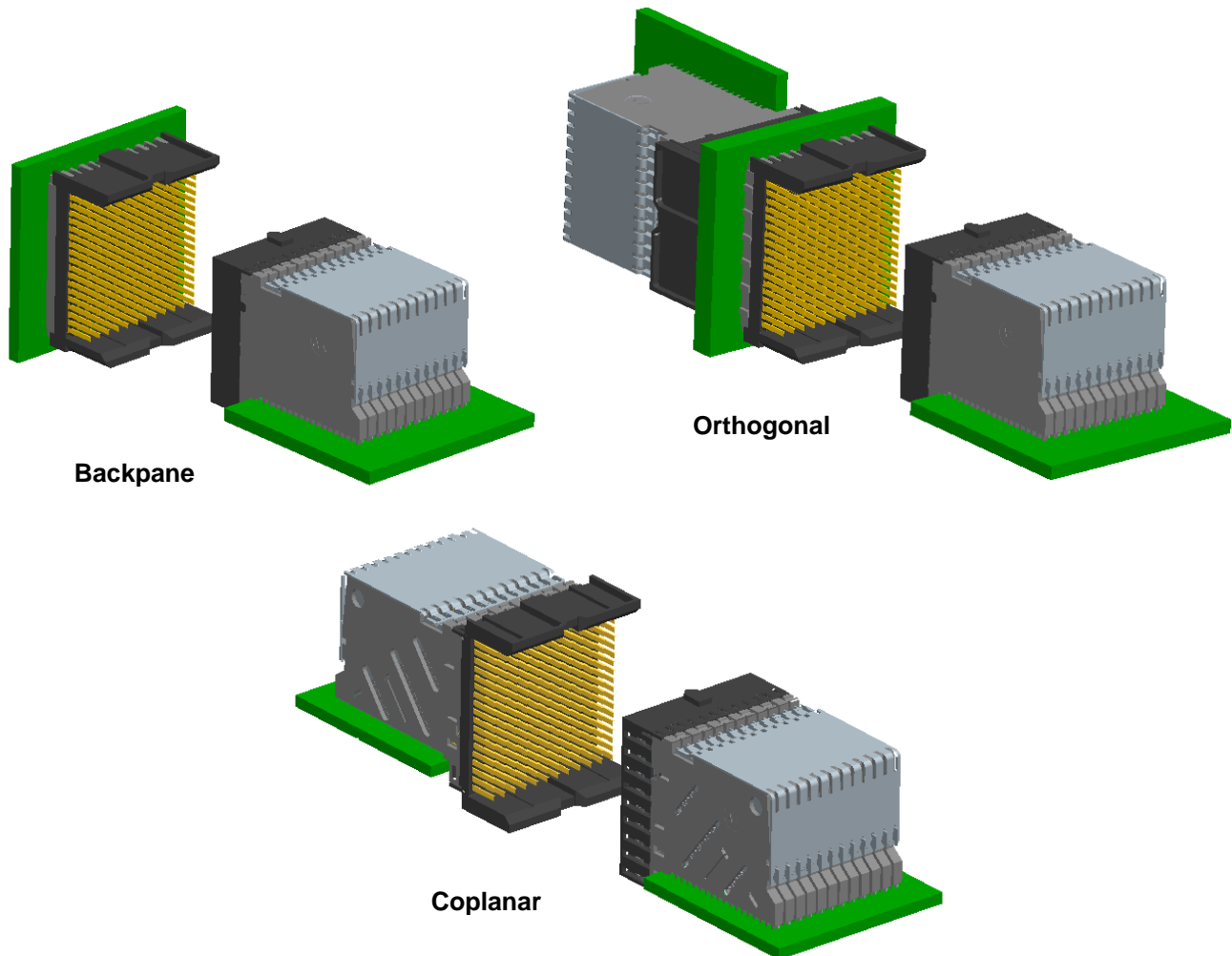



Figure 1: 216 position ZipLine™ signal connectors

NUMBER <b>GS-20-094</b>	TYPE <b>APPLICATION SPECIFICATION</b>		
TITLE <b>ZipLine™ Connector System</b>		PAGE <b>3 of 23</b>	REVISION <b>B</b>
		AUTHORIZED BY <b>M. Gray</b>	DATE <b>2009-10-05</b>
CLASSIFICATION <b>UNRESTRICTED</b>			

### 3. APPLICABLE DOCUMENTS

- Applicable FCI product customer drawings
- FCI Product Specification GS-12-452 (ZipLine™ Connector System)
- FCI repair manual 10085927
- FCI Product Specification GS-12-220 (2mm High Power Connector System)
- FCI Application Specification GS-20-023 (2mm High Power Connector System)
- FCI Application Specification GS-20-045 (Hard Metric Guide Connectors)
- FCI Form E-3699 (User Guide and Maps for ZipLine Orthogonal Routing)

FCI product drawings and specifications are available by accessing the FCI website or by contacting FCI Technical Service. Customers should refer to the latest revision level of FCI product drawings for appropriate product details.

### 4. GENERAL CUSTOMER INFORMATION

This document is a general application guide. If there is a conflict between the product drawings and this specification, the drawings take precedence.

#### 4.1. CONNECTOR CONFIGURATIONS

ZipLine™ press-fit headers are offered in both a vertical configuration for backpanel and orthogonal applications, and as a right angle configuration for coplanar applications. ZipLine™ press-fit receptacles are offered in a right angle configuration. The backpanel, orthogonal, and coplanar header assemblies all share the same mating interface. This allows one receptacle, provided it has the same number of columns and the same number of rows, to be mated with any of the fore mentioned header assemblies. Compliant press-fit tails provide a reliable electrical connection between the ZipLine™ connectors and the plated through hole (PTH) of the PCB. Press-fit tails eliminate the need for soldering processing of through-board solder tails. Press-fit technology simplifies rework of assembled boards by allowing a damaged connector to be removed and replaced. Each connector may be replaced with a new connector 2 times without damaging the PCB.

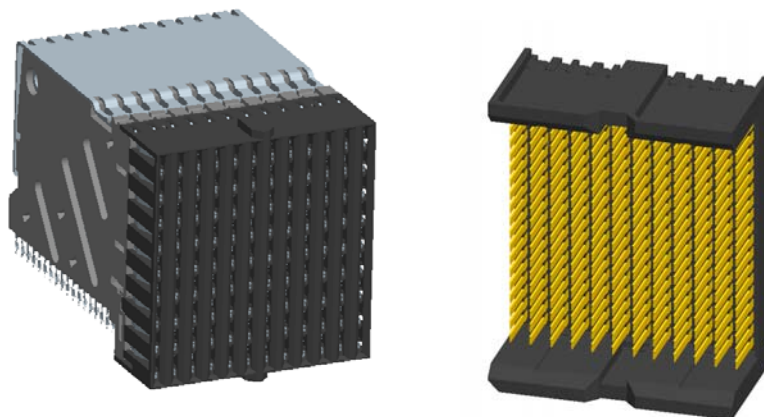
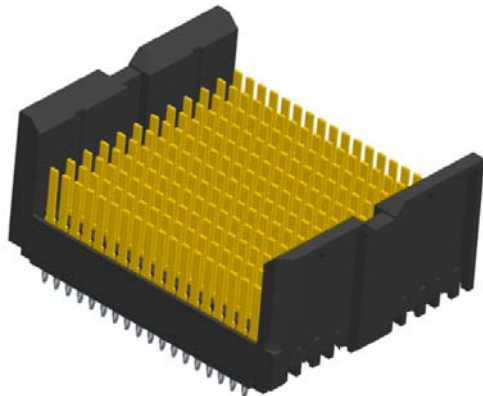

**Figure 2: ZipLine™ 6 pair / 1.8 mm pitch / 12 column connector assemblies**

NUMBER <b>GS-20-094</b>	TYPE <b>APPLICATION SPECIFICATION</b>		
TITLE <b>ZipLine™ Connector System</b>		PAGE 4 of 23	REVISION B
		AUTHORIZED BY M. Gray	DATE 2009-10-05
CLASSIFICATION <b>UNRESTRICTED</b>			

## 4.2. HEADER END WALLS

ZipLine™ press-fit headers are offered with 2-wall and 4-wall housing types. A 4-wall header will take 1.8mm more space in the direction of the card slot compared to a 2-wall header. The same right angle receptacle will mate to either a 2-wall or a 4-wall header assembly.



**2-wall header assembly**

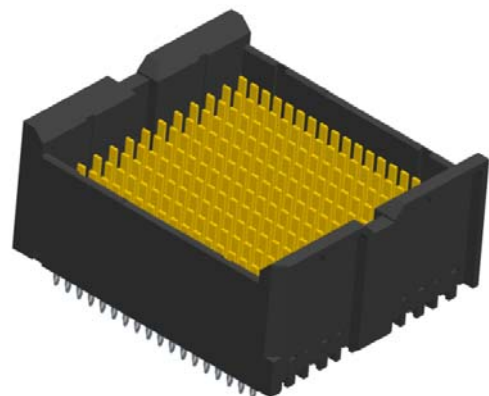

**4-wall header assembly**

## 4.3. SIGNAL CONNECTOR GUIDING FEATURES

Figure 4 shows the amount of misalignment in each direction that will be corrected by the housing guiding features as the connectors are mated. The same misalignment values apply to all configurations.

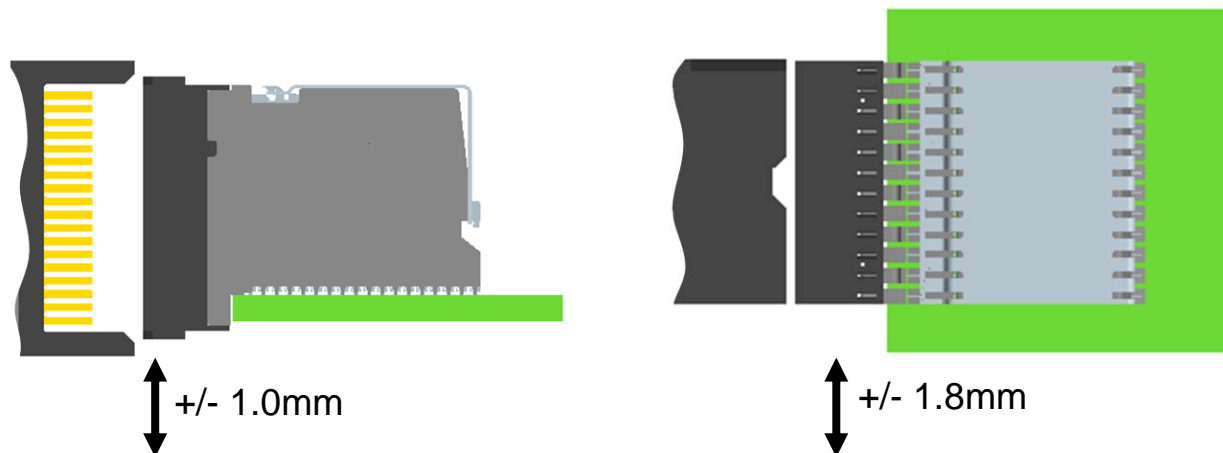

**Figure 4: Connector guidance in each direction**

The maximum acceptable angular misalignment of the receptacle relative to the header is +/- 2 degrees in either direction.

NUMBER <b>GS-20-094</b>	TYPE <b>APPLICATION SPECIFICATION</b>		
TITLE <b>ZipLine™ Connector System</b>		PAGE <b>5 of 23</b>	REVISION <b>B</b>
		AUTHORIZED BY <b>M. Gray</b>	DATE <b>2009-10-05</b>
CLASSIFICATION <b>UNRESTRICTED</b>			

#### 4.4. COMPATIBILITY WITH HARD METRIC PRODUCTS

The ZipLine™ Connector System is compatible with hard metric standards in that the board to board distance between mated connectors is 12.5 mm for both perpendicular and coplanar applications. See Figure 5 and Table 1 for dimensions relative to the top surface of the receptacle card.

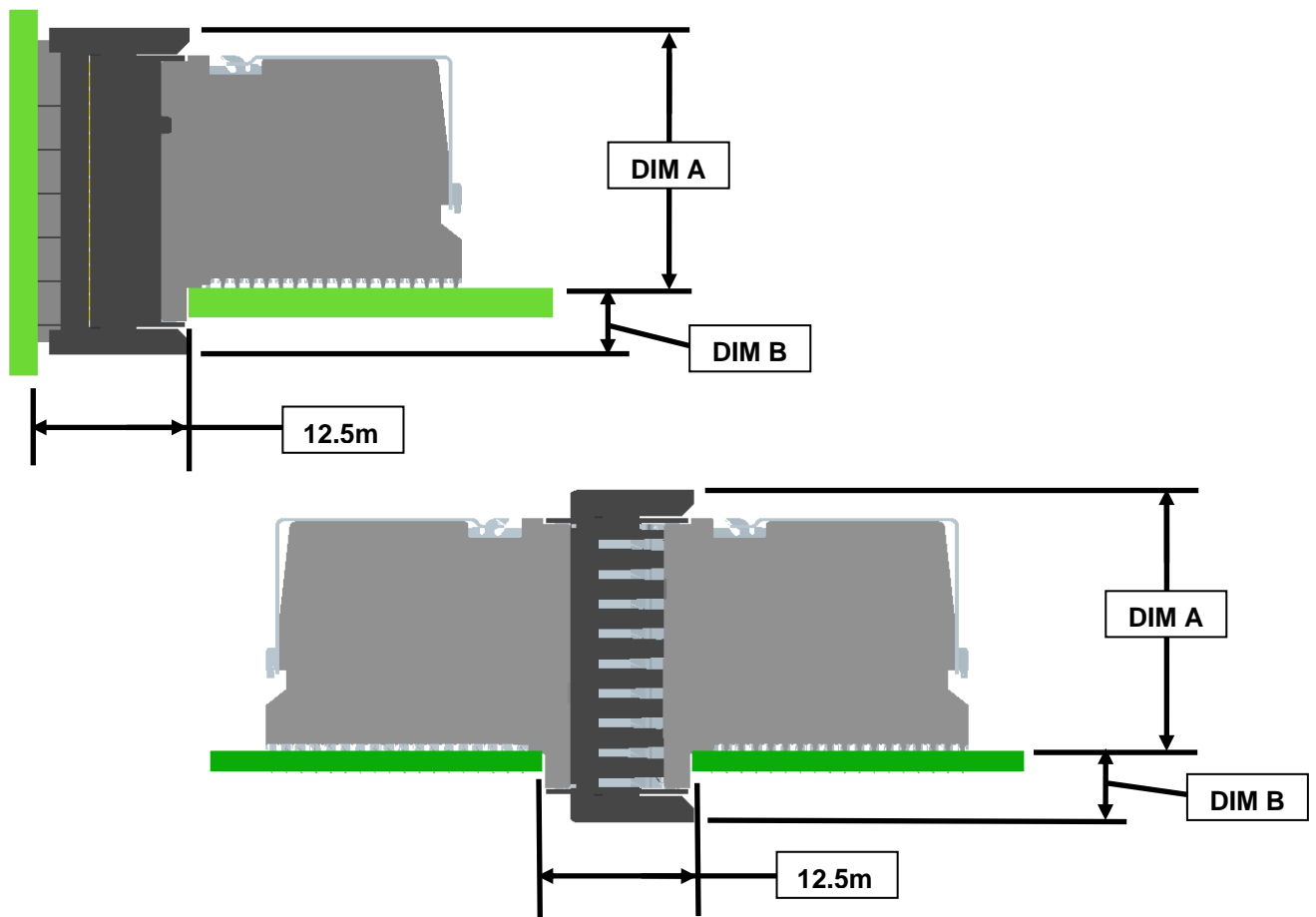



Figure 5: Side views of the ZipLine™ Connector System (6 pair connectors shown)

Connector Height	DIM A (top surface of receptacle card to top surface of header housing)	DIM B (top surface of receptacle card to bottom surface of header housing)
6 pair	21.3mm MAX	5.5mm MAX

Table1: Connector dimensions relative to the receptacle card

NUMBER <b>GS-20-094</b>	TYPE <b>APPLICATION SPECIFICATION</b>		
TITLE <b>ZipLine™ Connector System</b>		PAGE <b>6 of 23</b>	REVISION <b>B</b>
		AUTHORIZED BY <b>M. Gray</b>	DATE <b>2009-10-05</b>
CLASSIFICATION <b>UNRESTRICTED</b>			

#### 4.5. CONTACT WIPE DISTANCE

The nominal contact wipe distance for standard ZipLine™ signal and power pins is **2.6mm**. This value is at full normal force and does not include lead-in geometry on either mating half. This value assumes there is no gap between connector mating faces.

#### 4.6. SHORT DETECT PIN OPTION

A short detect pin option is available for ZipLine™ vertical headers. This pin has **2.00mm of contact wipe** at full normal force, which is 0.6mm less than all other header blades. Typically one assembly with short a detect pin will be placed at each end of a card slot, and the card is powered on when the two short detect pins mate.

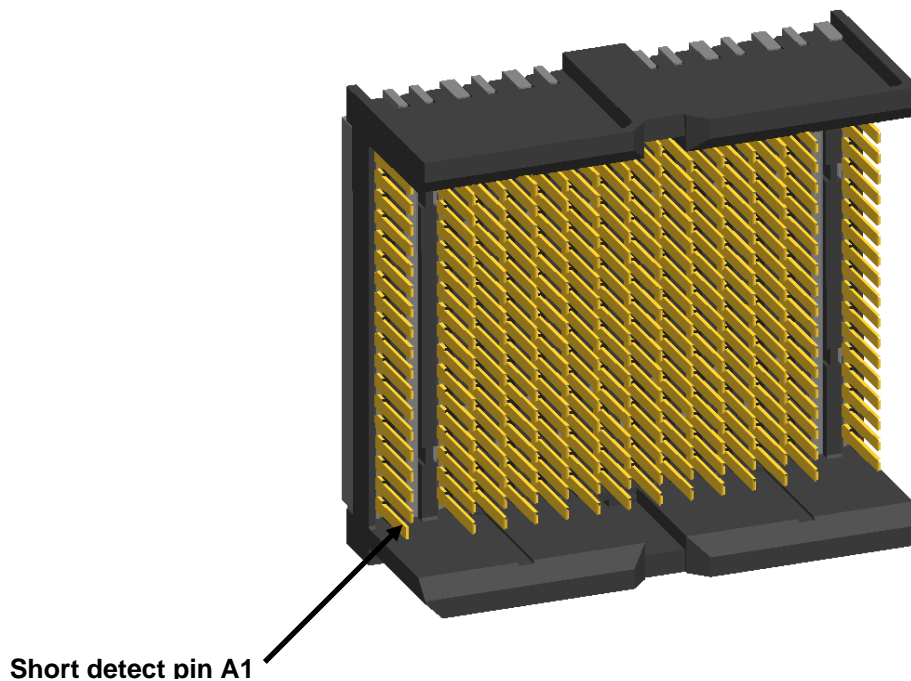



Figure 6: Short detect option

#### 4.7. SEPARATE GUIDE MODULES

**It is strongly recommended that separate guide modules be used to maximize the system's mechanical robustness.** One guide module should be placed at each end of a group of signal modules. If the amount of bow in a daughter card is expected to exceed the amount of signal connector guidance, then an additional guide module should be placed near the center of a group of signal modules. **Please refer to GS-20-045 for additional information on Hard Metric Guide Connectors.**

NUMBER <b>GS-20-094</b>	TYPE <b>APPLICATION SPECIFICATION</b>		
TITLE <b>ZipLine™ Connector System</b>		PAGE <b>7 of 23</b>	REVISION <b>B</b>
		AUTHORIZED BY <b>M. Gray</b>	DATE <b>2009-10-05</b>
		CLASSIFICATION <b>UNRESTRICTED</b>	

#### 4.8. FLEXIBLE SIGNAL IMLA LOADING

Each column of a ZipLine™ connector is comprised of one Insert Molded Leadframe Assembly (IMLA). IMLA's may be configured to transmit either signal or power (see section 4.9 for information on power IMLA's). For vertical headers, signal IMLA's may have tails in line for standard backpanel applications or they may have jogged tails for shared via orthogonal midplane applications. Because all ZipLine™ vertical headers use the same housing, it is possible to load a mix of standard backpanel signal IMLA's and shared hole midplane orthogonal signal IMLA's in the same assembly. Also, a standard backpanel connector can have every other column loaded to achieve a connector that is capable of routing 3 pairs of differential traces per column. For a 6 pair, 3.6mm pitch, 6 column configuration all pairs can be routed on 2 layers (see section 5.5 for a routing example).

Since all signal header IMLA's have the same mating interface design, the mating receptacle simply has to be loaded with IMLA's in the same columns as the mating header. See below for two examples of flexible signal IMLA loading:

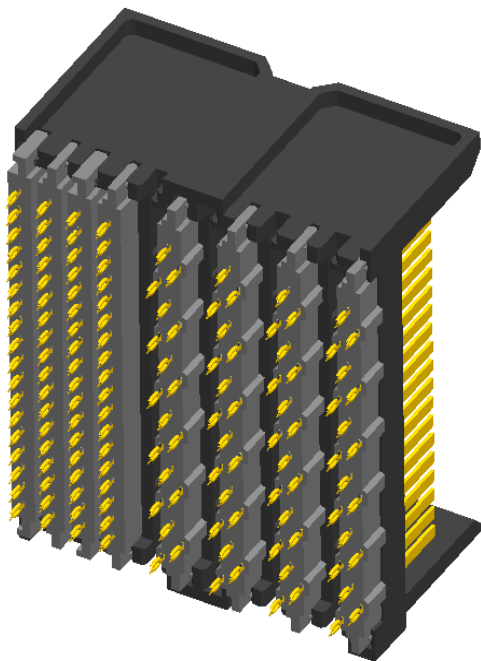

**4 backpanel IMLA's on 1.8mm pitch +  
4 orthogonal IMLA's on 3.6mm pitch**

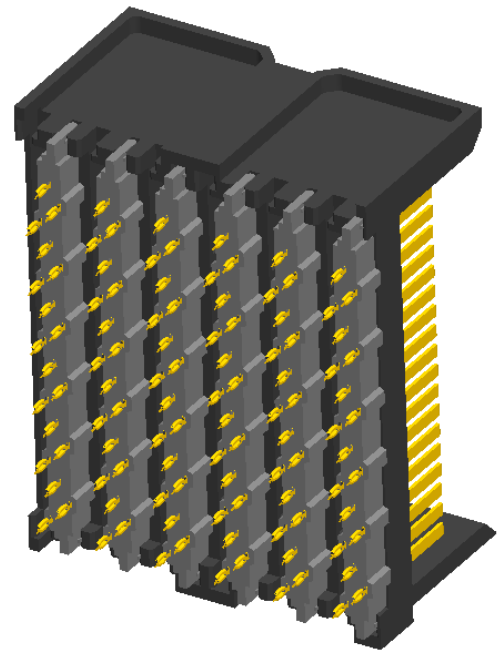

**6 orthogonal IMLA's on 3.6mm pitch**

**Figure 7: Examples of possible IMLA loading patterns**

NUMBER <b>GS-20-094</b>	TYPE <b>APPLICATION SPECIFICATION</b>		
TITLE <b>ZipLine™ Connector System</b>		PAGE <b>8 of 23</b>	REVISION <b>B</b>
		AUTHORIZED BY <b>M. Gray</b>	DATE <b>2009-10-05</b>
CLASSIFICATION <b>UNRESTRICTED</b>			

#### 4.9. INTEGRATED POWER IMLA's

The power IMLA will have one power pin for each pair of signal connector height. For example, a power IMLA that fits into a 6 pair high signal connector will have 6 separate power pins. **Per FCI Product specification GS-12-452, the current carrying capacity for a single power pin is 2.25A when fully loaded, 4.5A with 2 adjacent power IMLA's (as shown in Figure 8), and 6.0A with a single power IMLA (as shown in Figure 9). The maximum voltage that may be present on these power pins is 48V.** The power IMLA will be molded in a natural color to visually differentiate it from the black signal IMLA's.

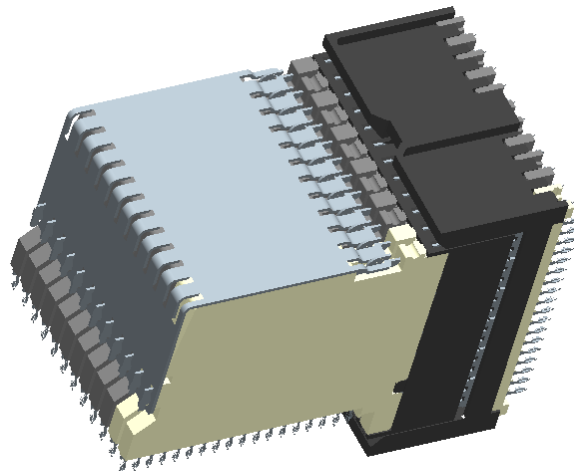

Figure 8: 10 signal IMLA's + 2 power IMLA's, all on 1.8mm column pitch

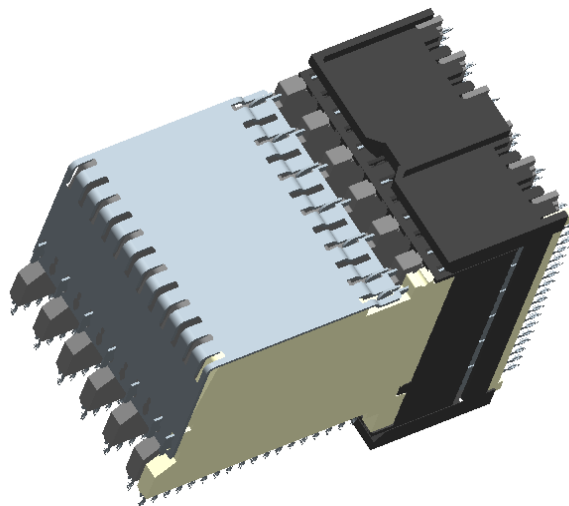



Figure 9: 6 signal IMLA's on 3.6mm column pitch + 1 power IMLA



NUMBER <b>GS-20-094</b>	TYPE <b>APPLICATION SPECIFICATION</b>		
TITLE <b>ZipLine™ Connector System</b>		PAGE 9 of 23	REVISION B
		AUTHORIZED BY M. Gray	DATE 2009-10-05
CLASSIFICATION <b>UNRESTRICTED</b>			

## 5. RECOMMENDATIONS FOR CUSTOMER PCB LAYOUT

### 5.1. DIFFERENTIAL PAIR vs. SINGLE-ENDED LAYOUTS

The same ZipLine™ connector may be used for differential pair and single-ended signals. Differential and single-ended pin assignments may be mixed within the same column. **It is recommended that the customer review any mixed layout with FCI to optimize high-speed performance.**

### 5.2. PIN ASSIGNMENTS FOR ORTHOGONAL HEADER FOOTPRINTS

ZipLine™ orthogonal headers have offset press-fit tails so that each differential pair on one side of the orthogonal midplane will share the same PCB via's as a differential pair on the other side of the midplane. Therefore, no high speed routing is required on the midplane, which allows for layer count and cost minimization of the midplane.

While midplane vertical headers can only be applied to the PCB in one orientation, the front (F) and rear (R) mating RAR connectors can be oriented with A1 mating to A1 (F0 or R0) or R12 mating with A1 (F180 or R180). To assist in PCB layout, FCI Form E-3699 provides visual maps and a table that lists the daughter card and midplane front and rear via IDs for the four possible orthogonal configurations shown below:

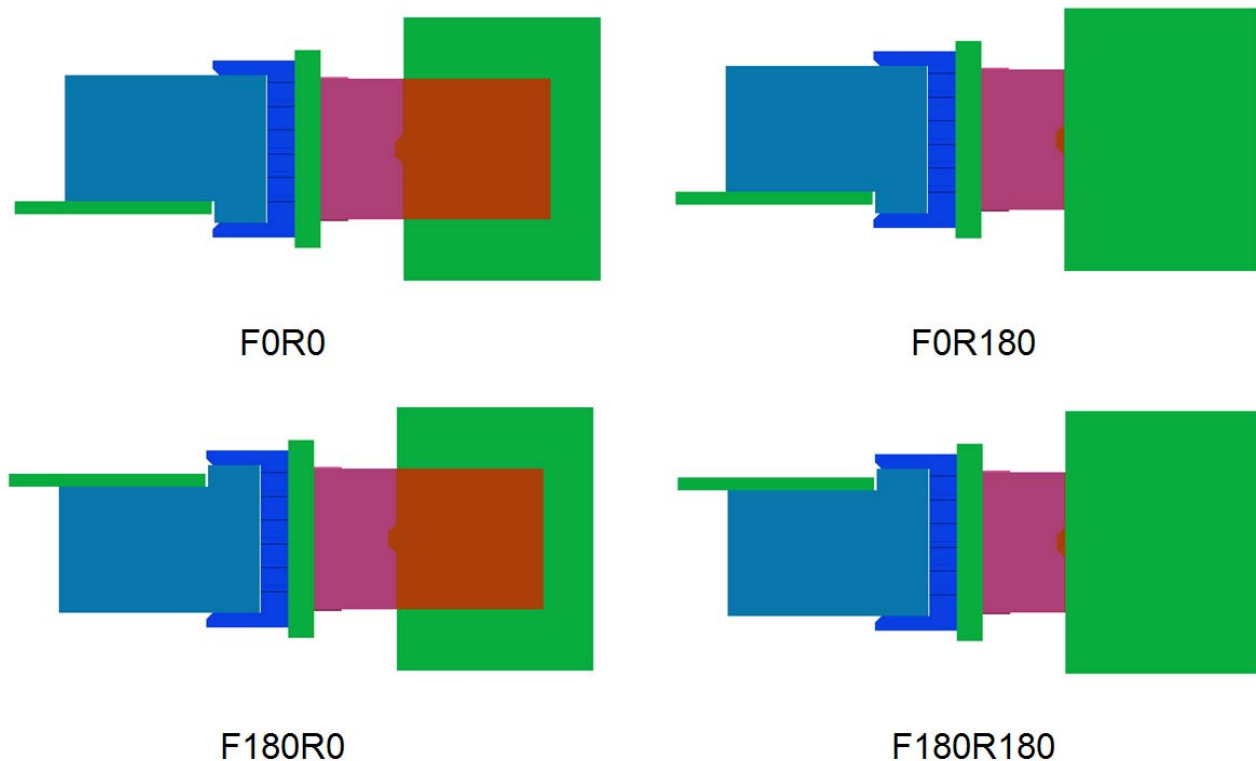

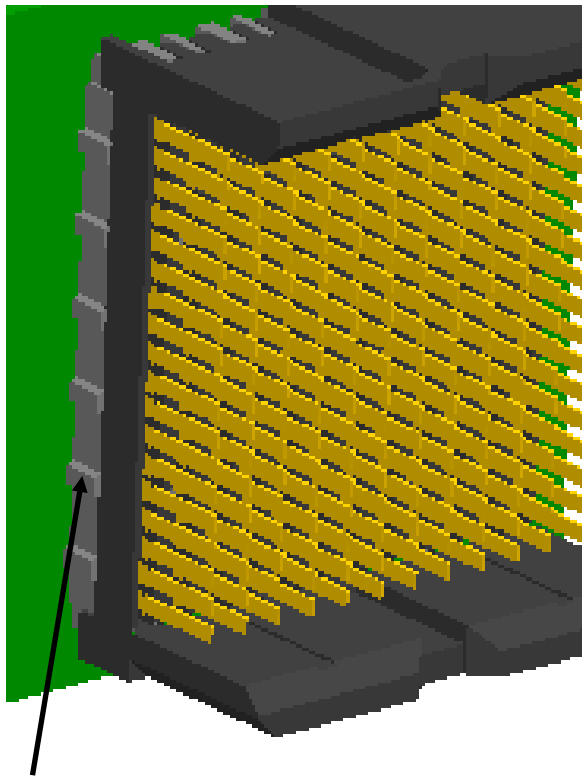

Figure 10: ZipLine™ Orthogonal Configurations

NUMBER <b>GS-20-094</b>	TYPE <b>APPLICATION SPECIFICATION</b>		
TITLE <b>ZipLine™ Connector System</b>		PAGE 10 of 23	REVISION B
		AUTHORIZED BY M. Gray	DATE 2009-10-05
CLASSIFICATION <b>UNRESTRICTED</b>			

### 5.3. PLACING A BACKPANEL HEADER NEXT TO AN ORTHOGONAL HEADER

For PCB layouts where a standard backpanel header module must be placed directly next to an orthogonal header module, an extra 0.2mm clearance must be added between the two connectors due to the protruding features found on the orthogonal header IMLA. See below for clarification.



Protrusions are present on each side of an orthogonal header – must add 0.2mm extra space to avoid interference

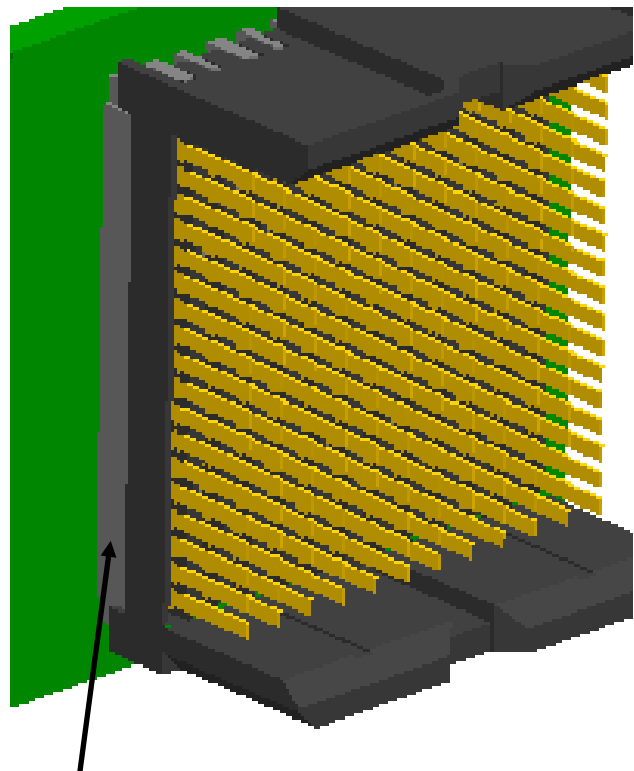

No protrusions are present on a standard backpanel header

Figure 11: View of orthogonal versus standard backpanel header

NUMBER <b>GS-20-094</b>	TYPE <b>APPLICATION SPECIFICATION</b>		
TITLE <b>ZipLine™ Connector System</b>		PAGE 11 of 23	REVISION B
		AUTHORIZED BY M. Gray	DATE 2009-10-05
CLASSIFICATION <b>UNRESTRICTED</b>			

#### 5.4. PCB TRACE ROUTING, 1.8 mm column pitch

ZipLine™ connectors having a 1.8mm column to column pitch allows for one differential pair, or two single-ended lines, to be routed in between columns per PCB layer. Refer to Figure 12 for a trace routing example. If a customer chooses to use narrower traces and/or spaces between traces than shown, then the antipad width can be increased accordingly to improve the footprint impedance.

		Layout	
		mil	µm
Column Pitch	<b>CP</b>	71.0	1803
Trace	<b>W</b>	8.0	203
Space	<b>S</b>	8.0	203
Pad Diameter	<b>P</b>	36.0	914
Antipad width	<b>Wa</b>	43.0	1092
Total Routing Width	<b>TRW</b>	24.0	610
Annular Ring	<b>Wr</b>	8.2	207
Clearance Drill~Trace	<b>Cd-t</b>	11.7	297
Clearance Pad~Trace	<b>Cp-t</b>	5.5	140
Clearance Antipad~Trace	<b>Ca-t</b>	2.0	51

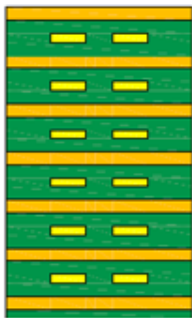
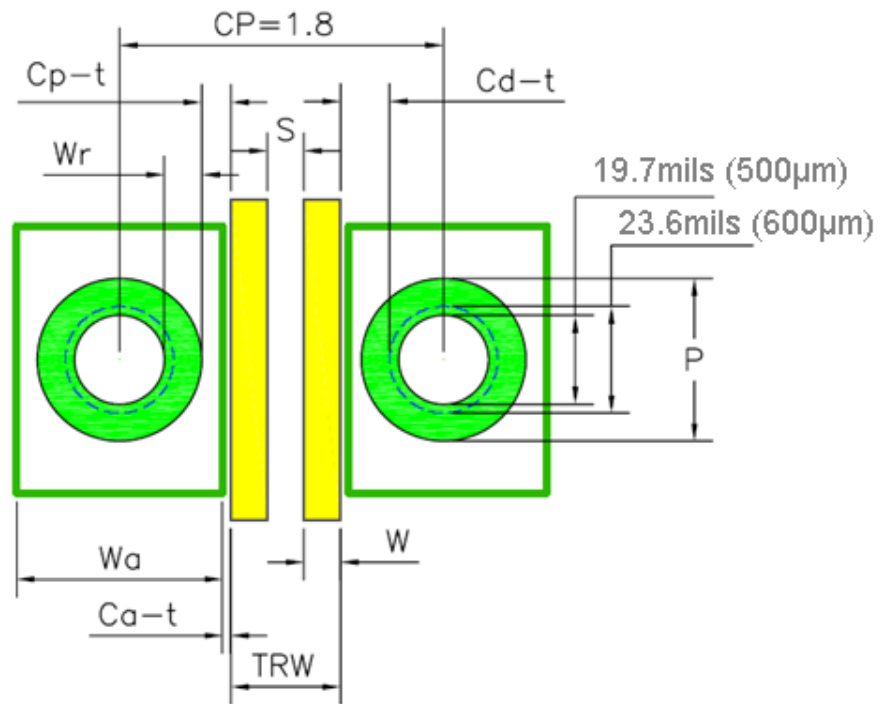

One differential pair per routing channel  
(6 high speed signal layers required to route 6 differential pairs)

Figure 12: PCB trace routing example, 1.8 mm pitch between columns

NUMBER <b>GS-20-094</b>	TYPE <b>APPLICATION SPECIFICATION</b>		
TITLE <b>ZipLine™ Connector System</b>		PAGE 12 of 23	REVISION B
		AUTHORIZED BY M. Gray	DATE 2009-10-05
CLASSIFICATION <b>UNRESTRICTED</b>			

### 5.5. PCB TRACE ROUTING, 3.6 mm column pitch

ZipLine™ connectors having a 3.6 mm column to column pitch allows for three differential pairs, or six single-ended lines, to be routed in between columns per PCB layer. Refer to Figure 13 for a trace routing example. If a customer chooses to use narrower traces and/or spaces between traces than shown, then the antipad width can be increased accordingly to improve the footprint impedance

		Layout	
		mil	µm
Column Pitch	<b>CP</b>	142.0	3607
Trace	<b>W</b>	6.0	152
Space	<b>S</b>	6.0	152
Pair~Pair Spacing	<b>Spp</b>	20.0	508
Pad Diameter	<b>P</b>	36.0	914
Antipad width	<b>Wa</b>	43.0	1092
Total Routing Width	<b>TRW</b>	94.0	2388
Annular Ring	<b>Wr</b>	8.2	207
Clearance Drill~Trace	<b>Cd-t</b>	12.2	310
Clearance Pad~Trace	<b>Cp-t</b>	6.0	152
Clearance Antipad~Trace	<b>Ca-t</b>	2.5	64

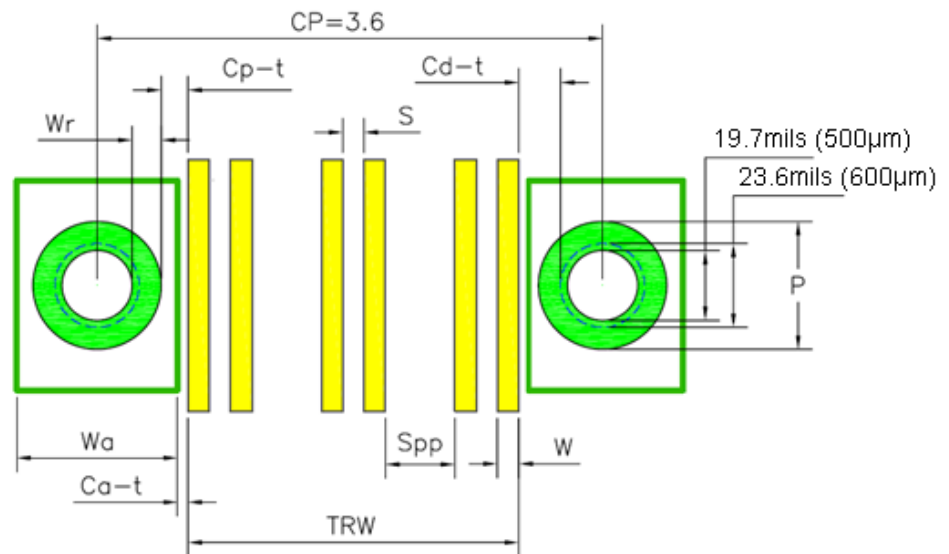

Two differential pairs per routing channel  
(Only 2 high speed signal layers required to route 6 differential pairs)

Figure 13: PCB trace routing example, 3.6 mm pitch between columns

NUMBER <b>GS-20-094</b>	TYPE <b>APPLICATION SPECIFICATION</b>		
TITLE <b>ZipLine™ Connector System</b>		PAGE <b>13 of 23</b>	REVISION <b>B</b>
		AUTHORIZED BY <b>M. Gray</b>	DATE <b>2009-10-05</b>
		CLASSIFICATION <b>UNRESTRICTED</b>	

## 5.6. SIGNAL TRACE ROUTING UNDER POWER IMLA'S ON A DAUGHTER CARD

For applications using power IMLA's (see section 4.8) care must be taken when routing signal traces on the top (component side) layer of the PCB under the power IMLA of a right angle connector. The power contacts are connected in groups of 3 press-fit tails and the metal leadframe touches the top side of the card when applied (see figure below). This means signal traces should not be routed on the top layer through a channel between via's of the same power contact to avoid the possibility of shorting to the power contact.

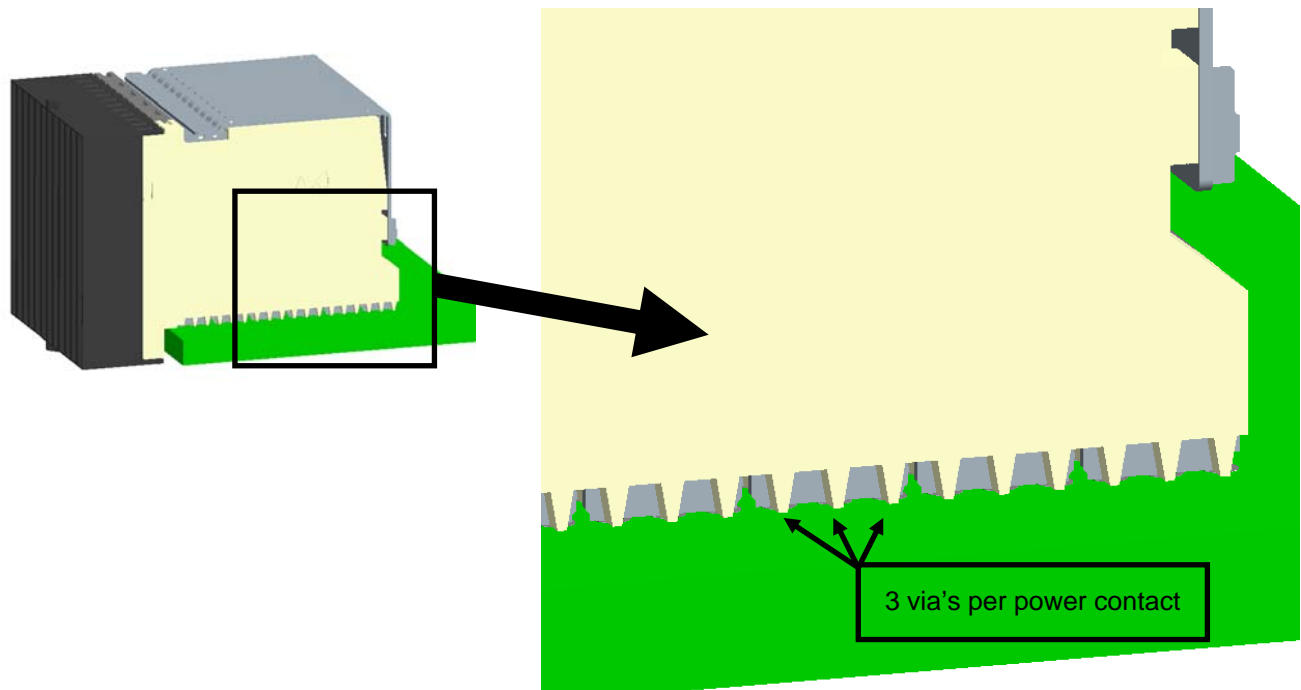



Figure 14: View of power IMLA

## 5.7. PRINTED CIRCUIT BOARD THICKNESS

The minimum nominal PCB thickness recommendation for daughter cards and backplanes is **1.60mm**. The absolute minimum PCB thickness recommendation for an orthogonal midplane is **3.5mm** because two press-fit tails enter into opposite sides of the same PCB via (the press-fit tail length specification is 1.60 +/- 0.15mm). There are no maximum thickness requirements.

NUMBER <b>GS-20-094</b>	TYPE <b>APPLICATION SPECIFICATION</b>		
TITLE <b>ZipLine™ Connector System</b>		PAGE <b>14 of 23</b>	REVISION <b>B</b>
		AUTHORIZED BY <b>M. Gray</b>	DATE <b>2009-10-05</b>
CLASSIFICATION <b>UNRESTRICTED</b>			

## 5.8. BACK DRILLING GUIDELINES

Back drilling is a method used by system designers to reduce the length of unused conductive via's which will improve high speed signal integrity performance. When back drilling is performed, it is important to avoid damaging the portion of the via that contacts the press-fit tail. See below for recommendations on proper back drilling.

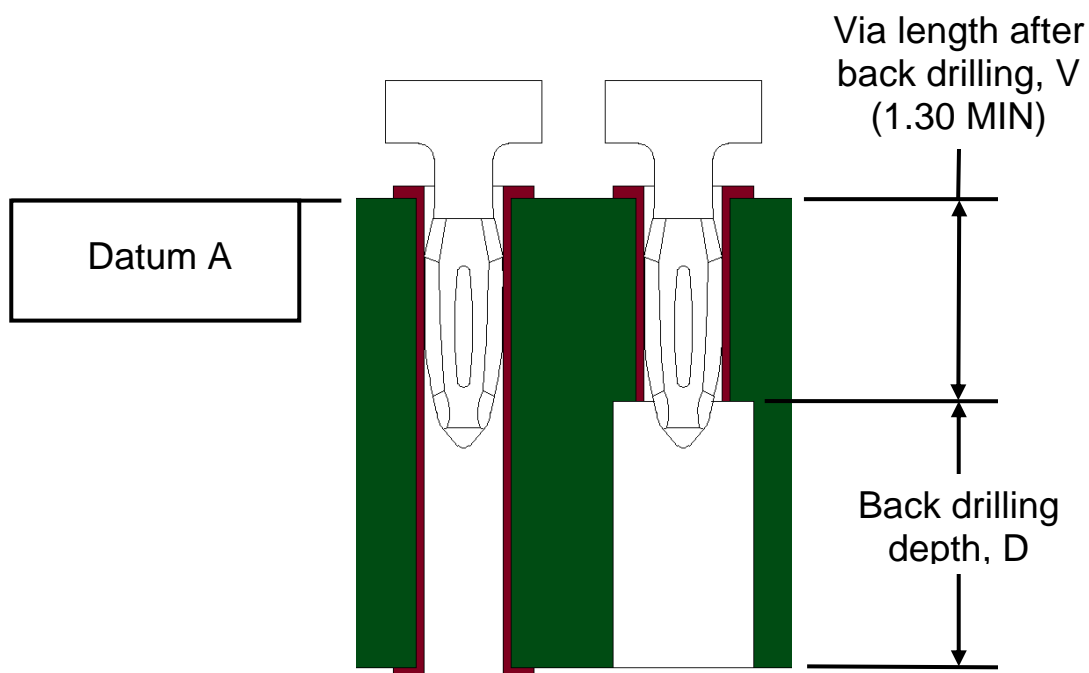

**Figure 15: Back drilled via's**

After back drilling, the remaining via barrel (dim V) must be at least 1.3mm to ensure a reliable connection between the AirMax VS® press-fit tails and the PCB. Assuming a back drilling depth tolerance of +/- 0.3mm relative to datum A, the nominal via length V will be 1.6mm (min V = 1.3mm; max V = 1.9mm).

## 5.9. PCB SCREEN PRINTING RECOMMENDATIONS

It is recommended to screen print the connector outline onto the PCB. Refer to the specific customer product drawing for the outlining details. For vertical headers, it is also recommended to print a polarization feature onto the PCB. This will help ensure that the connector is oriented properly on the board. As shown in figure 16, vertical headers have a chamfer at the A1 position that can serve as the polarization feature.

NUMBER <b>GS-20-094</b>	TYPE <b>APPLICATION SPECIFICATION</b>		
TITLE <b>ZipLine™ Connector System</b>		PAGE 15 of 23	REVISION B
		AUTHORIZED BY M. Gray	DATE 2009-10-05
CLASSIFICATION <b>UNRESTRICTED</b>			

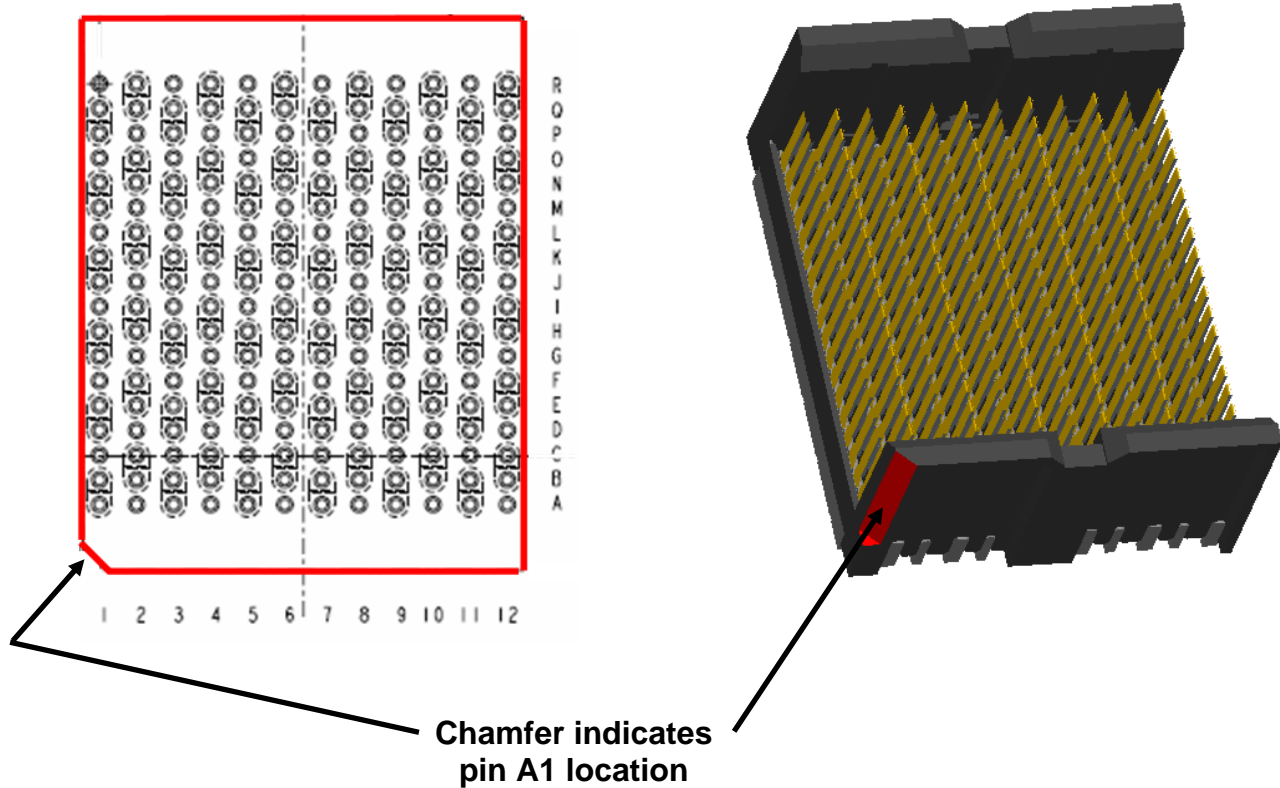



Figure 16: Vertical header outline with polarization feature

### 5.10. KEEP-OUT ZONES FOR APPLICATION AND REMOVAL TOOLING:

There are no keep-out zones necessary for application tooling because these tools fit within the outside envelope of the header and receptacle assemblies.

There may be a need for keep-out zones for connector removal tooling. Refer to the FCI Manuals listed in section 10 for information on removal tools and procedures. In general, the need for keep-outs will depend on the specific PCB layout. To be more specific, factors such as pitch definition between adjacent daughter cards and location and type of any nearby connectors all affect the requirements. It is possible to design a system so that no extra keep-out zones are needed.

NUMBER <b>GS-20-094</b>	TYPE <b>APPLICATION SPECIFICATION</b>		
TITLE <b>ZipLine™ Connector System</b>		PAGE 16 of 23	REVISION B
		AUTHORIZED BY M. Gray	DATE 2009-10-05
CLASSIFICATION <b>UNRESTRICTED</b>			

## 6. APPLICATION TOOLING

### 6.1. VERTICAL HEADER

The application tools recommended for ZipLine™ vertical headers are shown in Table 2. **A special bottom support tool with holes for tail tips will be necessary only if the connector tails are longer than the thickness of the backplane (the tail length specification is 1.60mm +/- 0.15mm).** This tool could be a PCB with oversized holes or a custom tool designed by the user.

Header type	Connector module width, mm		Insertion tool part no.
	2 Wall	4 Wall	
6 pair, 12 IMLA, 1.8mm pitch	21.6	23.4	10078013
6 pair, 16 IMLA, 1.8mm pitch	28.8	30.6	10086893

Table 2: Part numbers for header application tools

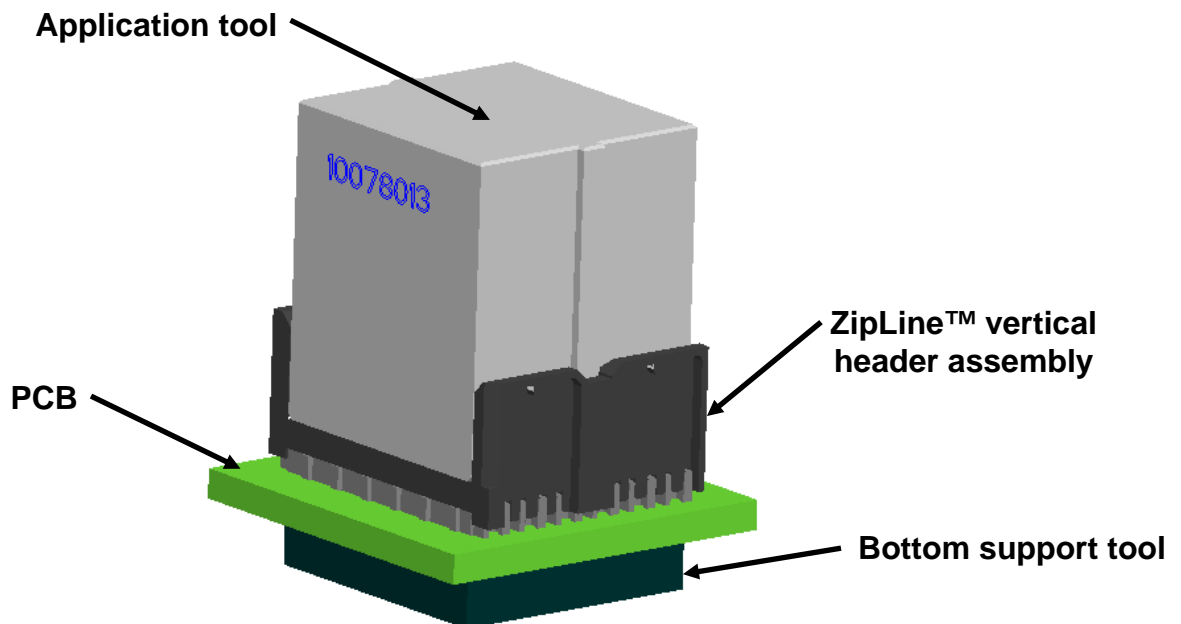



Figure 17: ZipLine™ vertical header application tool (6pair, 12 IMLA shown)



NUMBER <b>GS-20-094</b>	TYPE <b>APPLICATION SPECIFICATION</b>		
TITLE <b>ZipLine™ Connector System</b>		PAGE 17 of 23	REVISION B
		AUTHORIZED BY M. Gray	DATE 2009-10-05
CLASSIFICATION <b>UNRESTRICTED</b>			

## 6.2. RIGHT ANGLE RECEPTACLE

The application tools recommended for ZipLine™ right angle receptacles are shown in Table 3. **A special bottom support tool will be necessary only if the connector tails are longer than the thickness of the daughter card (the tail length specification is 1.60mm +/- 0.15mm).** This tool could be a PCB with oversized holes or a custom tool designed by the user.

Receptacle type	Module width, mm	Insertion tool part no.
6 pair, 12 IMLA, 1.8mm pitch	21.6	10082873
6 pair, 16 IMLA, 1.8mm pitch	28.8	10086892

Table 3: part numbers for receptacle application tools

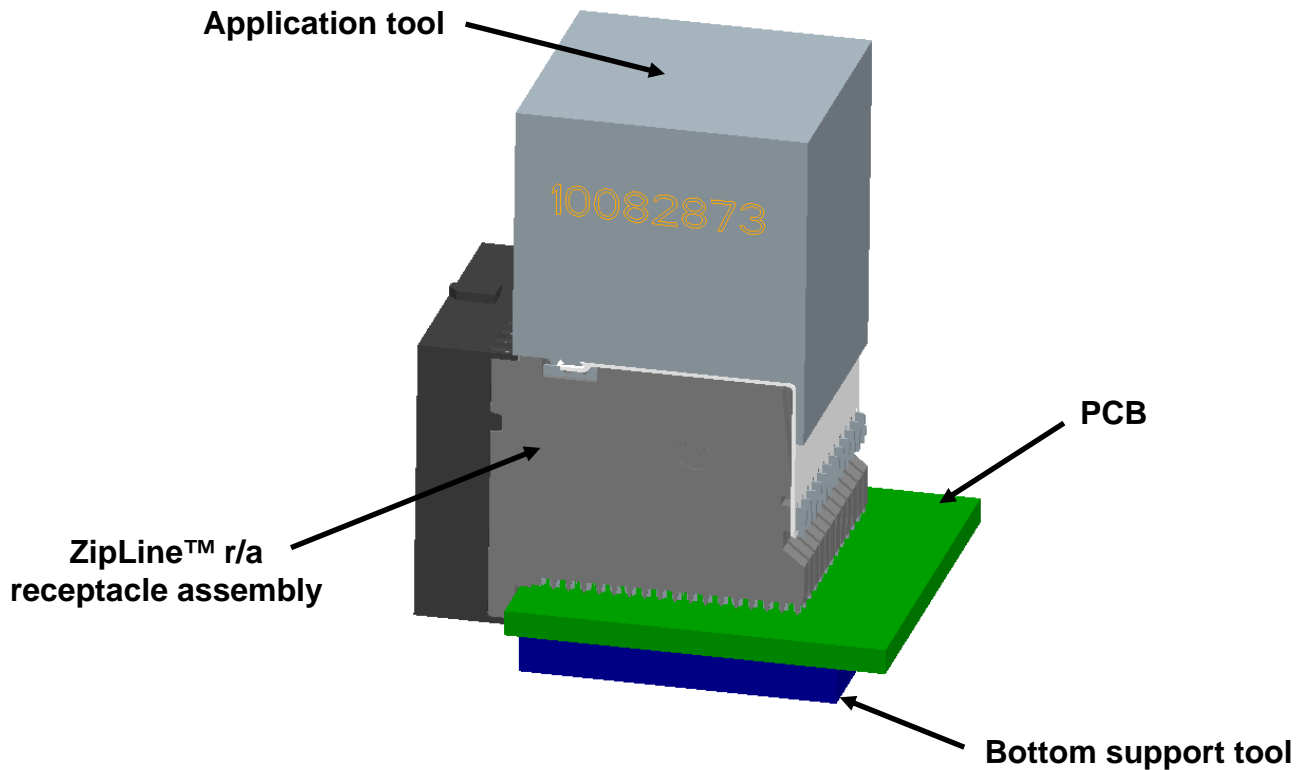



Figure 18: ZipLine™ right angle receptacle application tool (6pair, 12 IMLA shown)

NUMBER <b>GS-20-094</b>	TYPE <b>APPLICATION SPECIFICATION</b>		
TITLE <b>ZipLine™ Connector System</b>		PAGE 18 of 23	REVISION B
		AUTHORIZED BY M. Gray	DATE 2009-10-05
CLASSIFICATION <b>UNRESTRICTED</b>			

### 6.3. RIGHT ANGLE HEADER

The application tools recommended for ZipLine™ right angle headers are shown in Table 4. **A special bottom support tool will be necessary only if the connector tails are longer than the thickness of the daughter card (the tail length specification is 1.60mm +/- 0.15mm).** This tool could be a PCB with oversized holes or a custom tool designed by the user.

Right angle header type	Module width, mm	Insertion tool part no.
6 pair, 12 IMLA, 1.8mm pitch	21.6	10082873

Table 4: part numbers for right angle header application tools

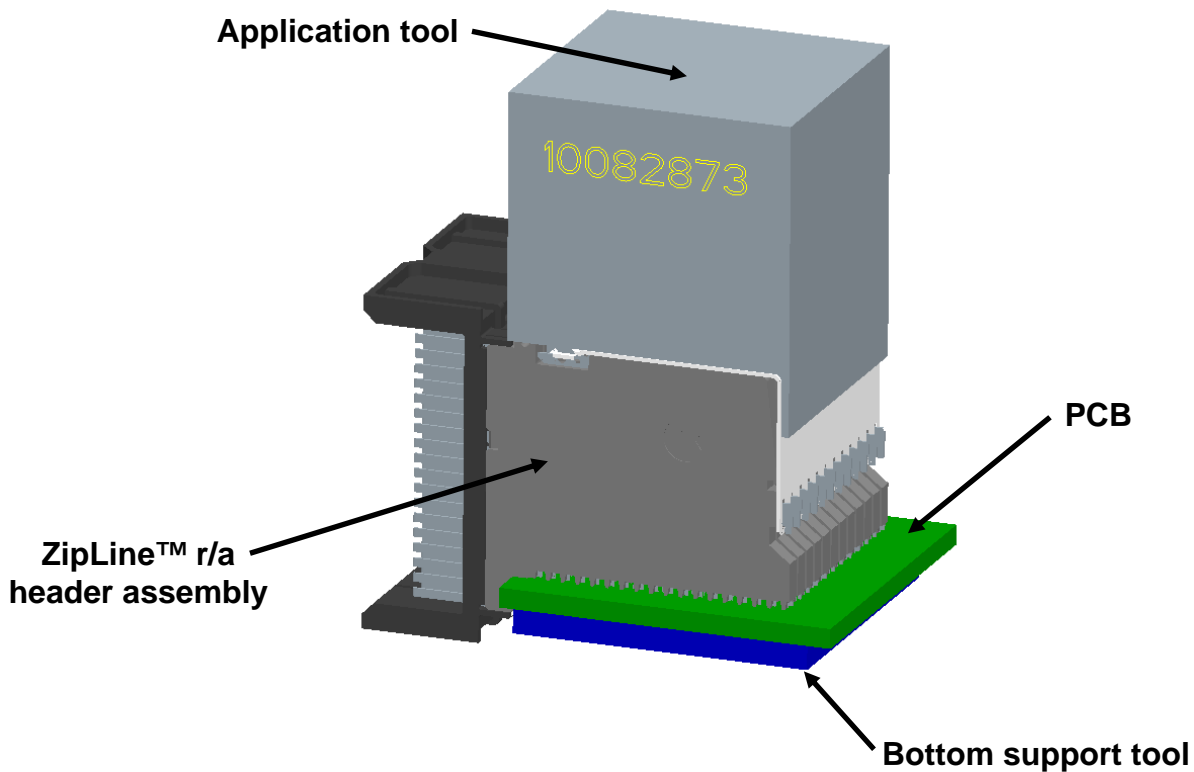



Figure 19: ZipLine™ right angle header application tool (6pair, 12 IMLA shown)

NUMBER <b>GS-20-094</b>	TYPE <b>APPLICATION SPECIFICATION</b>		
TITLE <b>ZipLine™ Connector System</b>		PAGE 19 of 23	REVISION B
		AUTHORIZED BY M. Gray	DATE 2009-10-05
CLASSIFICATION <b>UNRESTRICTED</b>			

## 7. RECOMMENDED INSERTION FORCES AND SPEED

The recommended maximum insertion force per each press-fit pin is 25 N (5.62 lbf).

**EXAMPLE:** For a 6 pair 12 IMLA ZipLine™ connector there are 216 press-fit tails that are to be inserted into the PCB. Therefore, the maximum recommended press setting would be 5400 N (216 press-fit tails x 25 N) or 1214 lbf.

These maximum force recommendations have been determined to yield acceptable insertion results for PCB holes within FCI's recommended guidelines. **While it is acceptable to use a lower insertion force per press-fit pin, steps should be taken to guarantee that the connector is seated properly (see Section 9).** Force settings will vary with different types of PTH finishes. Customers should develop parameters that best suit individual application requirements. Inserting to a specified force will yield more consistent results than inserting to a set distance. Actuation of the insertion press should be slow and controlled, not fast like a punch press. To prevent improperly pressed connectors (i.e. bent pins), it is recommended that the press speed does not exceed 75 mm/min (0.05 in/sec).

## 8. APPLICATION PROCEDURE

The application procedure for all connector configurations is as follows:

- Place the connector assembly on the PCB taking care to insure that the press-fit tails are lined up with their respective holes. It is important to mount the connector in the correct orientation. As written in section 5.9 it is recommended to screen print the connector outline onto the PCB.

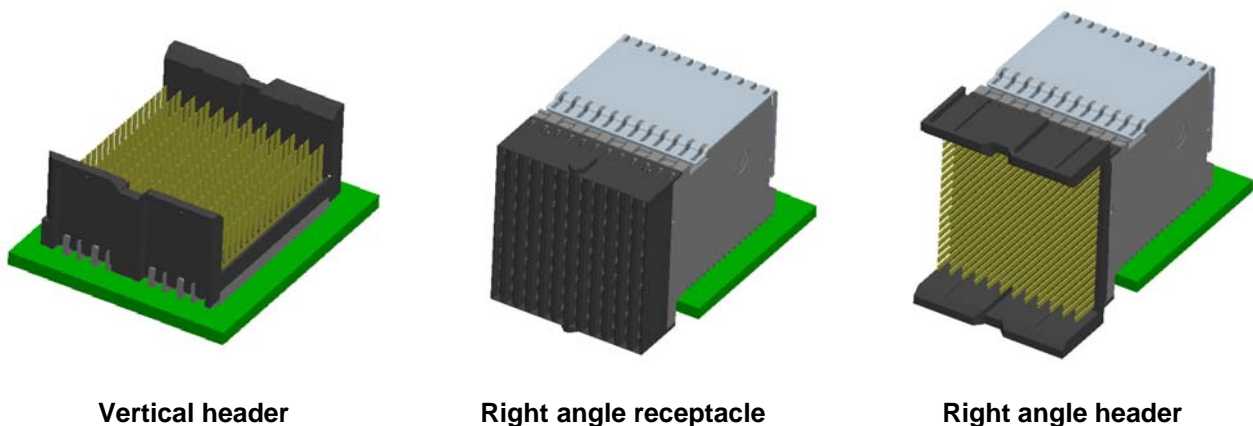

**Figure 20: Connectors placed on the PCB**

NUMBER <b>GS-20-094</b>	TYPE <b>APPLICATION SPECIFICATION</b>		
TITLE <b>ZipLine™ Connector System</b>		PAGE <b>20 of 23</b>	REVISION <b>B</b>
		AUTHORIZED BY <b>M. Gray</b>	DATE <b>2009-10-05</b>
CLASSIFICATION <b>UNRESTRICTED</b>			

- Place an application tool (and PCB support if needed) on the connector as shown in figure 21 below.

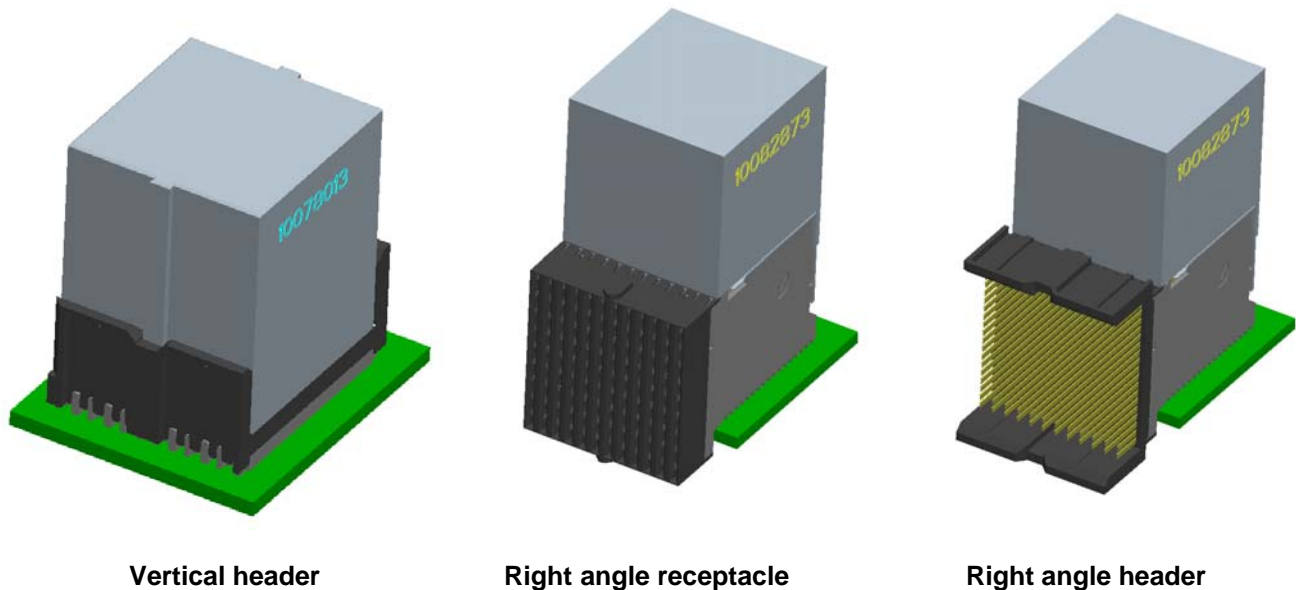

**Figure 21: Connectors with application tool installed.**

- **To ensure proper insertion, connectors must be centered beneath the press ram.** Offset loading may result in improper seating of the header and mating problems.
- Actuate the insertion press. Refer to section 7 for the recommended insertion force and speed.
- Remove the assembly from the insertion press.
- Remove the insertion tool from the connector.
- Inspect product for proper application. Refer to section 9 for post application inspection requirements.

NUMBER <b>GS-20-094</b>	TYPE <b>APPLICATION SPECIFICATION</b>		
TITLE <b>ZipLine™ Connector System</b>		PAGE <b>21 of 23</b>	REVISION <b>B</b>
		AUTHORIZED BY <b>M. Gray</b>	DATE <b>2009-10-05</b>
CLASSIFICATION <b>UNRESTRICTED</b>			

## 9. POST-APPLICATION INSPECTION REQUIREMENTS

Post-application inspection should consist of several simple checks to assure that the connector is applied properly and is not damaged.

- Visually assure that all press-fit tails are seated in the proper PCB holes and that none have been crushed during application.
- For vertical headers, visually assure that the A1 positional marker on the connector housing is properly located relative to the outline screened on the PCB surface. Also make sure the plastic surface above the press-fit tails is seated against the top surface of the PCB (see Figure 22).

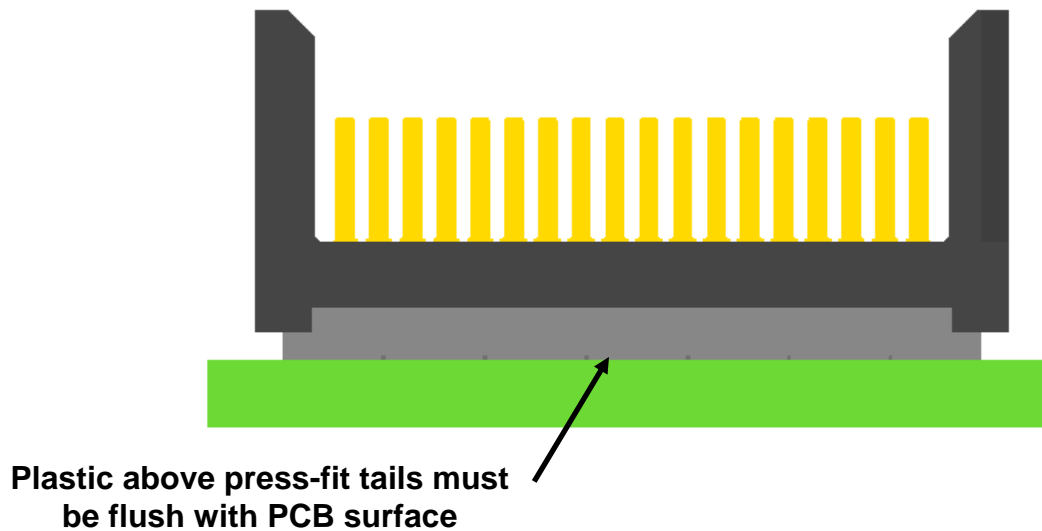

**Figure 22: Proper seating depth for vertical headers**

NUMBER <b>GS-20-094</b>	TYPE <b>APPLICATION SPECIFICATION</b>		
TITLE <b>ZipLine™ Connector System</b>		PAGE <b>22 of 23</b>	REVISION <b>B</b>
		AUTHORIZED BY <b>M. Gray</b>	DATE <b>2009-10-05</b>
CLASSIFICATION <b>UNRESTRICTED</b>			

- For right angle connectors, visually assure that the metal standoffs on the bottom of each assembly are seated against the top surface of the PCB. A gap beneath the standoffs indicates that the connector is not seated fully or is not seated parallel to the board (See figure 23). This can cause misalignment when mating with the corresponding connector.

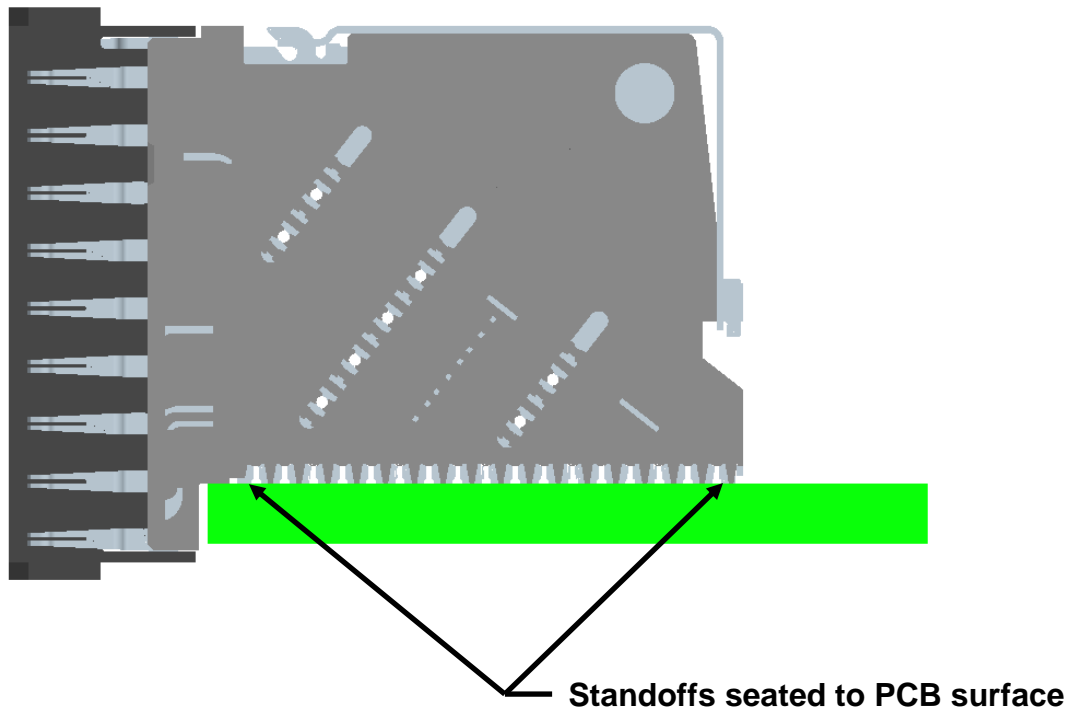



Figure 23: Proper seating depth for right angle connectors (receptacle shown)

## 10. CONNECTOR REMOVAL TOOLING

Table 5 contains the connector removal tool part number and corresponding manual number that is recommended to remove a damaged ZipLine™ connector from a PCB. The referenced manual describes the proper connector removal procedures. For some connector configurations it may be possible to use multiple repair methods.

Connector type	Column pitch, mm	Module width, mm	Removal tool part no.	FCI manual no.
6 pair	any	any	10082877	10085927

Table 5: Connector removal tooling part numbers

NUMBER <b>GS-20-094</b>	TYPE <b>APPLICATION SPECIFICATION</b>		
TITLE <b>ZipLine™ Connector System</b>		PAGE <b>23 of 23</b>	REVISION <b>B</b>
		AUTHORIZED BY <b>M. Gray</b>	DATE <b>2009-10-05</b>
CLASSIFICATION <b>UNRESTRICTED</b>			

## 11. REVISION RECORD

REV	PAGE	DESCRIPTION	EC #	DATE
A	All	Initial Release	V09-0145	2009-04-08
B	All	Added information to the entire document pertaining to the right angle header and coplanar applications. See ECR V09-0484 for specific details.	V09-0484	2009-10-07