



NUMBER GS-20-0305	TYPE Application Specification		
TITLE AirMax VSe® / VS2® Connector System, right angle press-fit products		PAGE 1 of 16	REVISION B
		AUTHORIZED BY Tao Zhan	DATE 2014-04-23
		CLASSIFICATION UNRESTRICTED	

TABLE OF CONTENTS

1.0	OBJECTIVE	2
2.0	SCOPE	2
3.0	DRAWINGS AND APPLICABLE DOCUMENTS.....	2
4.0	GENERAL INFORMATION	2
4.1	PRODUCT DESCRIPTION	2
4.2	PRODUCT CONFIGURATIONS	3
4.3	COMPATIBILITY WITH HARD METRIC PRODUCTS	4
4.4	RIGHT ANGLE HEADER MATING VARIATIONS:.....	5
4.5	CONTACT WIPE DISTANCES:	7
4.6	SIGNAL CONNECTOR GUIDING FEATURES:	7
4.7	SEPARATE GUIDE MODULES:	8
5.0	PCB LAYOUT INFORMATION	8
5.1	BOARD THICKNESS.....	8
5.2	CONNECTOR TO CONNECTOR SPACING:	8
5.3	PCB SCREEN PRINTING RECOMMENDATIONS:	8
5.4	KEEP-OUT ZONES FOR APPLICATION AND REMOVAL TOOLING:	8
5.5	PCB TRACE ROUTING	9
5.5.1	2MM PITCH BETWEEN ADJACENT COLUMNS.....	9
5.6	BACK DRILLING.....	10
6.0	APPLICATION TOOLING	10
6.1	CONNECTOR INSERTION TOOLING	10
6.2	INSERTION PRESSES	11
7.0	RECOMMENDED INSERTION FORCES	11
8.0	APPLICATION PROCEDURE	12
9.0	POST-APPLICATION INSPECTION PROCEDURES.....	13
10.0	CONNECTOR REMOVAL TOOLING.....	15
11.0	RECORD RETENTION	16

This document is the property of and embodies CONFIDENTIAL and PROPRIETARY information of FCI. No part of the information shown on the document may be used in any way or disclosed to others without the written consent of FCI. Copyright FCI.

NUMBER GS-20-0305	TYPE Application Specification		
TITLE AirMax VSe [®] / VS2 [®] Connector System, right angle press-fit products		PAGE 2 of 16	REVISION B
		AUTHORIZED BY Tao Zhan	DATE 2014-04-23
CLASSIFICATION UNRESTRICTED			

1.0 OBJECTIVE

This specification provides information and requirements regarding customer application of the AirMax VSe[®]/VS2[®] right angle receptacle and header with press-fit termination. This specification is intended to provide general guidance for application process development. It is recognized that no single application process will work under all customer scenarios and that customers will develop their own application processes to meet their needs. However, if these application processes differ greatly from the one recommended, FCI cannot guarantee results.

2.0 SCOPE

This specification provides information and requirements regarding customer application of AirMax VSe[®]/VS2[®] right angle receptacle and header with press-fit termination.

3.0 DRAWINGS AND APPLICABLE DOCUMENTS

- FCI PRODUCT SPECIFICATION GS-12-0956
- FCI PRODUCT CUSTOMER DRAWINGS
- FCI CUSTOMER DRAWING 10104444 (Recommended Via Drill Sizes and Plating)
- FCI APPLICATION SPECIFICATION GS-20-035 (AirMax VS[®])
- FCI APPLICATION SPECIFICATION GS-20-045 (Hard Metric Guide Connectors)

FCI product drawings and specifications can be obtained by accessing the FCI website www.fci.com or contacting FCI Technical Service. In the event of a conflict between this application specification and the drawing, the drawing will take precedence. Customers are advised to refer to the latest revision level of FCI product drawings for appropriate details.

4.0 GENERAL INFORMATION

This document is meant to be an application guide. If there is a conflict between the product drawings and specifications, the drawings take precedence.

4.1 PRODUCT DESCRIPTION

The AirMax VSe[®]/VS2[®] right angle receptacle and right angle header are electrically enhanced versions of the standard AirMax VS[®] products providing improved signal integrity performance. The AirMax VSe[®]/VS2[®] receptacle is designed to be mating compatible with either an AirMax VS[®] or AirMax VSe[®]/VS2[®] header having the same mating grid (i.e. the same number of contact rows, columns, and spacing). Special variations of the AirMax VSe[®] right angle header are required for mating to either an AirMax VS[®] or an AirMax VSe[®]/VS2[®] receptacle. The AirMax VSe[®]/VS2[®] products use compliant press-fit tails to provide a reliable electrical connection between the connector and the plated through hole (PTH) of the PCB. AirMax VSe[®] products have a small press-fit section, designed for a Ø0.40mm finished through hole, for signal terminals and standard press-fit sections, designed for a Ø0.50mm finished through hole, for the ground terminals. As such, the AirMax VSe[®] products are not PCB foot print compatible with the AirMax VS[®] products which use standard press fit sections (Ø 0.50mm finished through hole) for all terminals.

NUMBER GS-20-0305	TYPE Application Specification		
TITLE AirMax VSe® / VS2® Connector System, right angle press-fit products		PAGE 3 of 16	REVISION B
		AUTHORIZED BY Tao Zhan	DATE 2014-04-23
CLASSIFICATION UNRESTRICTED			

4.2 PRODUCT CONFIGURATIONS

The AirMax VSe®/VS2® press-fit receptacles are currently offered in the right angle configurations shown in Table 1 below.

Number of Positions	Number of Rows	Number of Columns	Column Spacing
54	9 (3 Pair)	6	2mm
120	12 (4 Pair)	10	2mm
150	15 (5 Pair)	10	2mm
192	12 (4 Pair)	16	2mm

Table 1: Connector configuration offering – Right Angle Receptacles

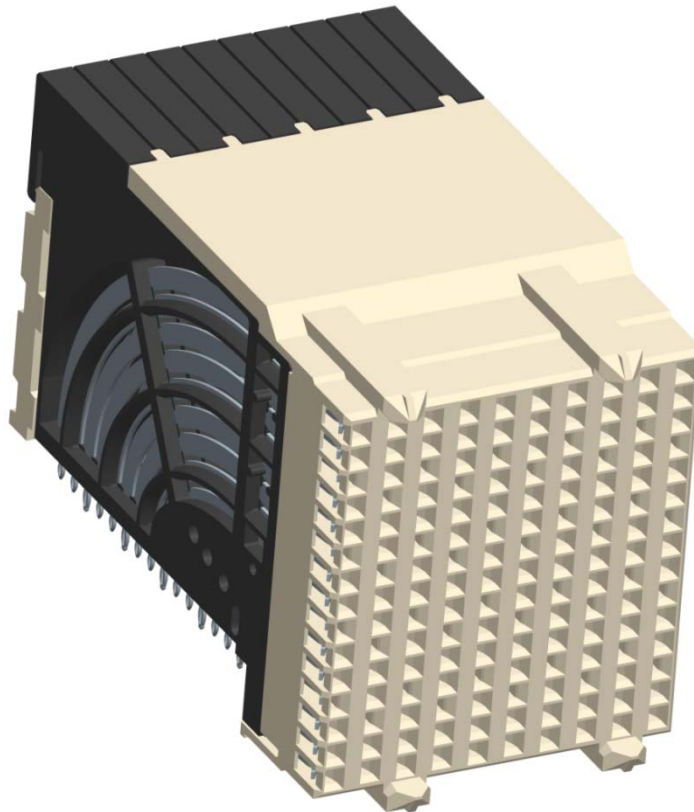



Figure 1: Right angle receptacle assembly - 5 pair / 2mm pitch / 10 column version show

NUMBER GS-20-0305	TYPE Application Specification		
TITLE AirMax VSe [®] / VS2 [®] Connector System, right angle press-fit products		PAGE 4 of 16	REVISION B
		AUTHORIZED BY Tao Zhan	DATE 2014-04-23
		CLASSIFICATION UNRESTRICTED	

The AirMax VSe[®]/VS2[®] press-fit header is currently offered in the right angle configuration shown in Table 2 below.

Number of Positions	Number of Rows	Number of Columns	Column Spacing
54	9 (3 Pair)	6	2mm
120	12 (4 Pair)	10	2mm
150	15 (5 Pair)	10	2mm

Table 2: Connector configuration offering – Right Angle Headers

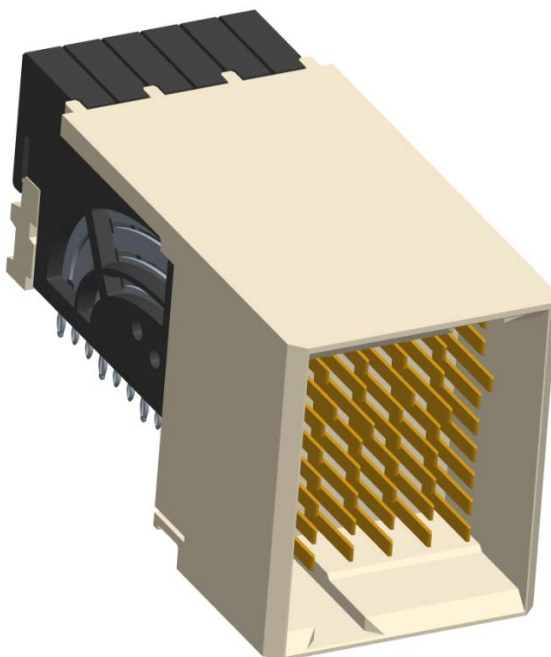



Figure 2: Right angle header assembly - 3 pair / 2mm pitch / 6 column version show

4.3 COMPATIBILITY WITH HARD METRIC PRODUCTS

This document is the property of and embodies CONFIDENTIAL and PROPRIETARY information of FCI. No part of the information shown on the document may be used in any way or disclosed to others without the written consent of FCI. Copyright FCI.

NUMBER GS-20-0305	TYPE Application Specification		
TITLE AirMax VSe® / VS2® Connector System, right angle press-fit products		PAGE 5 of 16	REVISION B
		AUTHORIZED BY Tao Zhan	DATE 2014-04-23
CLASSIFICATION UNRESTRICTED			

The AirMax VSe® / VS2® and AirMax VS® products are compatible with hard metric standards in that the distance between the backplane and front edge of the daughter card is 12.5mm for back panel applications, and 12.5mm between cards for coplanar applications. See Figures 3 and 4 and Tables 3 and 4 for dimensions relative to the daughter card for both back panel and coplanar applications.

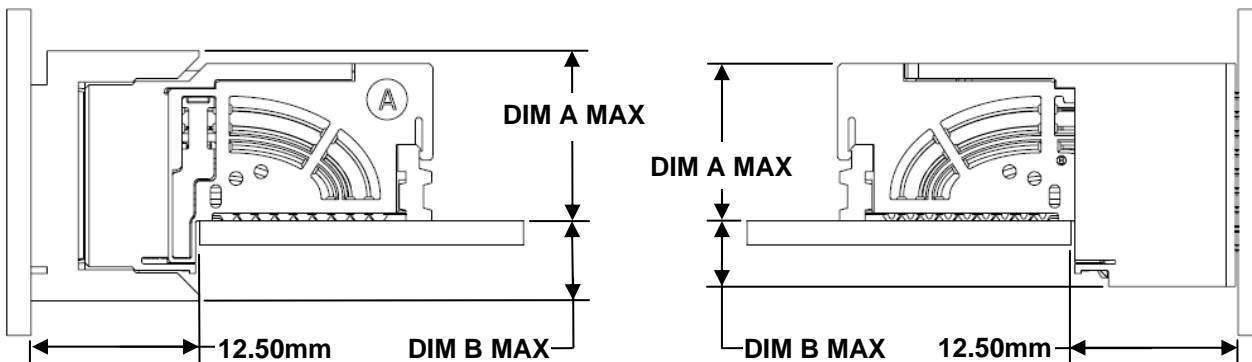

Figure 3: View of Back Panel Applications

Connector type	Minimum pitch between adjacent daughter cards,		DIM A (mm)		DIM B (mm)	
	Wide Body	Narrow Body	Wide Body	Narrow Body	Wide Body	Narrow Body
5 pair	26.9	25.1	20.95	20.1	5.95	5.0
4 pair	22.7	20.9	16.75	15.9	5.95	5.0
3 Pair	18.5	16.7	12.55	11.7	5.95	5.0

Table 3: Connector Dimensions for Back Panel Applications (Relative to the daughter card)

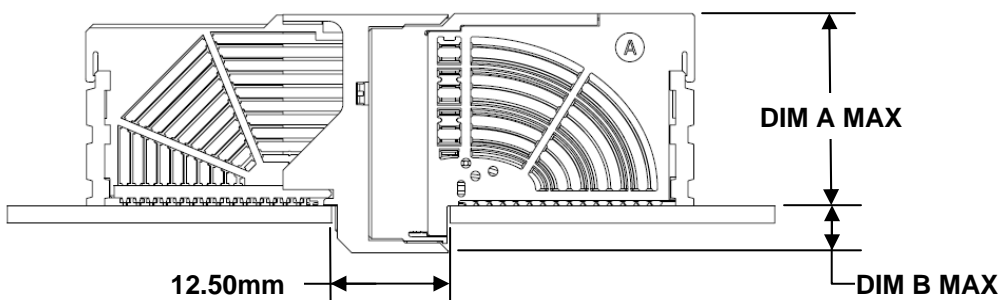



Figure 4: View of Coplanar Application

Connector type	Minimum pitch between adjacent daughter cards, mm	DIM A MAX, mm	DIM B MAX, mm
5 pair	25.1 mm	20.1	5.0
4 pair	20.5 mm	15.9	4.6
3 pair	16.7 mm	11.7	5.0

Table 4: Connector Dimensions for Coplanar Applications (Relative to the daughter card)

4.4 RIGHT ANGLE HEADER MATING VARIATONS:

NUMBER GS-20-0305	TYPE Application Specification		
TITLE AirMax VSe [®] / VS2 [®] Connector System, right angle press-fit products		PAGE 6 of 16	REVISION B
		AUTHORIZED BY Tao Zhan	DATE 2014-04-23
		CLASSIFICATION UNRESTRICTED	

There are two variations of the AirMax VSe[®]/VS2[®] right angle header. Single side plating and double sided plating variation is for mating zone plating requirement. Determining which variation is required for your application depends on whether the header will be mated to an AirMax VS[®] receptacle, or an AirMax VSe[®]/VS2[®] receptacle. Both the AirMax VS[®] and the AirMax VSe[®]/VS2[®] receptacles use two points of electrical contact per mating beam however, the AirMax VS[®] receptacle uses dual sided contact and the AirMax VSe[®]/VS2[®] receptacle uses single sided mating. This means for the AirMax VS[®] products the electrical points of contact are on opposite sides of the header blade, and for the AirMax VSe[®]/VS2[®] receptacle, the points of contact are on the same side of the header blade.

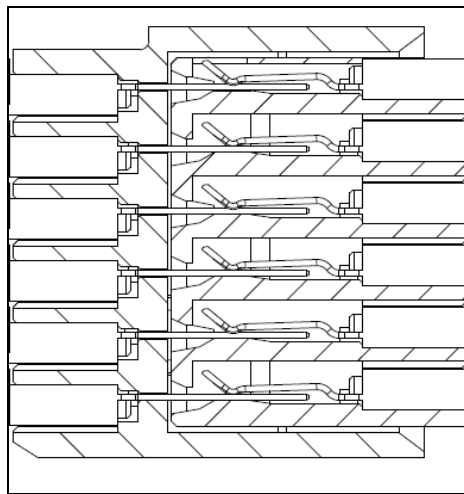

Figure 4: AirMax VSe[®] / VS2[®] receptacle uses single sided mating

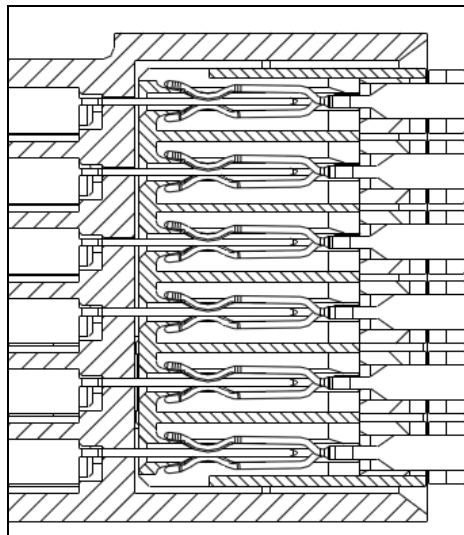



Figure 5: AirMax VS[®] receptacle uses dual sided mating

NUMBER GS-20-0305	TYPE Application Specification		
TITLE AirMax VSe® / VS2® Connector System, right angle press-fit products		PAGE 7 of 16	REVISION B
		AUTHORIZED BY Tao Zhan	DATE 2014-04-23
		CLASSIFICATION UNRESTRICTED	

4.5 CONTACT WIPE DISTANCES:

Table 5 shows the nominal contact wipe distances for both back panel and coplanar configurations. All values are at full normal force and do not include lead-in geometry on either mating half. All values assume there is no gap between connector mating faces.

Product Configuration	Header Type	Receptacle Type	First Mate	Secondary Mate	Short Detect (optional)
Backpanel	VS	VSe/VS2	3.2mm	2.25mm	1.75mm
Backpanel	VSe/VS2	VS	3.5mm	2.5mm	2.0mm
Coplanar	VS	VSe/VS2	3.8mm	2.15mm	1.65mm
Coplanar	VSe/VS2	VS/VSe/VS2	3.3mm	2.35mm	1.85mm

Table 5: Nominal Contact Wipe Distances

4.6 SIGNAL CONNECTOR GUIDING FEATURES:

Tables 6 and 7 show the amount of misalignment in each direction that will be corrected by the guiding features on signal connector housings as they are mated.

Connector type	Nominal misalignment correction in direction perpendicular to daughter card		Nominal misalignment correction in direction parallel to daughter card
	Wide body	Narrow body	Wide body and Narrow body
5 pair	+/- 2.0 mm	+/- 1.0 mm	+/- 1.7mm
4 pair	+/- 2.0 mm	+/- 1.0 mm	+/- 1.7 mm
3 pair	+/- 2.0 mm	+/- 1.0 mm	+/- 1.7 mm

Table 6: Connector Guidance for Back Panel Header Application

Connector type	Nominal misalignment correction in direction perpendicular to daughter card	Nominal misalignment correction in direction parallel to daughter card
5 pair	+/- 1.0 mm	+/- 1.7 mm
4 pair	+/- 0.6 mm	+/- 1.3 mm
3 pair	+/- 1.0 mm	+/- 1.7 mm

Table 7: Connector Guidance for Coplanar Application

NUMBER GS-20-0305	TYPE Application Specification		
TITLE AirMax VSe [®] / VS2 [®] Connector System, right angle press-fit products		PAGE 8 of 16	REVISION B
		AUTHORIZED BY Tao Zhan	DATE 2014-04-23
CLASSIFICATION UNRESTRICTED			

The maximum acceptable angular misalignment of the daughter card relative to the backplane is +/- 2 degrees in either direction in systems that do not have short detect pins. If short detect pins are used please refer to section 4.6 of FCI application specification GS-20-035 for recommendations.

4.7 SEPARATE GUIDE MODULES:

It is strongly recommended that separate guide modules be used to maximize the system's mechanical robustness. One guide module should be placed at each end of a group of signal modules. If the amount of bow in a daughter card exceeds the amount of signal connector guidance, then an additional guide module should be placed near the center of a group of signal modules. Please refer to GS-20-045 for additional information on Hard Metric Guide Connectors.

5.0 PCB LAYOUT INFORMATION

5.1 BOARD THICKNESS

The minimum nominal PCB thickness recommendation for daughter cards is 1.60mm. There is no maximum thickness requirement.

5.2 CONNECTOR TO CONNECTOR SPACING:

In general, the connector-to-connector centerline spacing will depend on the chosen header configuration with respect to end wall design. For example, if all headers on a given daughter card are 54-position with end walls, then the connector pitch will be 14.0mm for that card. However if all headers are 54-position without end walls, the connector pitch will be 12.0mm. If there is a mixture of 54-position headers with end walls and without end walls, then the centerline distance between any two adjacent dissimilar headers will be 13.0mm. This type of PCB layout information is included on the customer drawings.

5.3 PCB SCREEN PRINTING RECOMMENDATIONS:

It is recommended to print the outline of the receptacle onto the PCB to insure proper placement of the connector. Detailed information of the recommended outline is provided on the customer drawing.

5.4 KEEP-OUT ZONES FOR APPLICATION AND REMOVAL TOOLING:

There are no keep-out zones necessary for application tooling because these tools fit within the outside envelope of the connector assemblies.

There may be a need for keep-out zones for connector removal tooling. Refer to the FCI Manuals listed in section 10.0 for information on removal tools and procedures. In general, the need for keep-outs will depend on the specific PCB layout. To be more specific, factors such as pitch definition between adjacent daughter cards, selection of headers with end walls or without, and location and type of any nearby connectors all affect the requirements. It is possible to design a system so that no extra keep-out zones are needed.

This document is the property of and embodies CONFIDENTIAL and PROPRIETARY information of FCI. No part of the information shown on the document may be used in any way or disclosed to others without the written consent of FCI. Copyright FCI.

NUMBER GS-20-0305	TYPE Application Specification	FCI	
TITLE AirMax VSe® / VS2® Connector System, right angle press-fit products		PAGE 9 of 16	REVISION B
		AUTHORIZED BY Tao Zhan	DATE 2014-04-23
CLASSIFICATION UNRESTRICTED			

5.5 PCB TRACE ROUTING

To minimize trace loss in high-speed systems, board designers typically prefer to use trace widths no smaller than 0.20mm. The desired impedance between adjacent traces will define the spacing between those traces. The board designer will ultimately determine these parameters for a given system.

5.5.1 2mm PITCH BETWEEN ADJACENT COLUMNS

The routing lane is defined by the size of the anti pads and the column spacing. On a 2mm pitch between columns, one differential pair or two single-ended lines can be routed per PCB layer. This assumes 0.15mm wide traces and a 0.127mm wide space between a pair of traces. Refer to Figure 7 for a couple of trace routing examples.

Table of Dimensions (μm)			
Dimension		Example 1	Example 2
Column pitch	CP	2000	2000
Trace	W	150	203
Space	S	127	297
Pad	P	800	814
Antipad	Wa	1500	1145
Total Routing Width	TRW	427	703
Annular Ring	Wr	200	207
Clearance Drill - Trace	Cd-t	536.5	399.0
Clearance Pad-Trace	Cp-t	386.5	241.0
Clearance Antipad-Trace	Ca-t	36.5	76.0

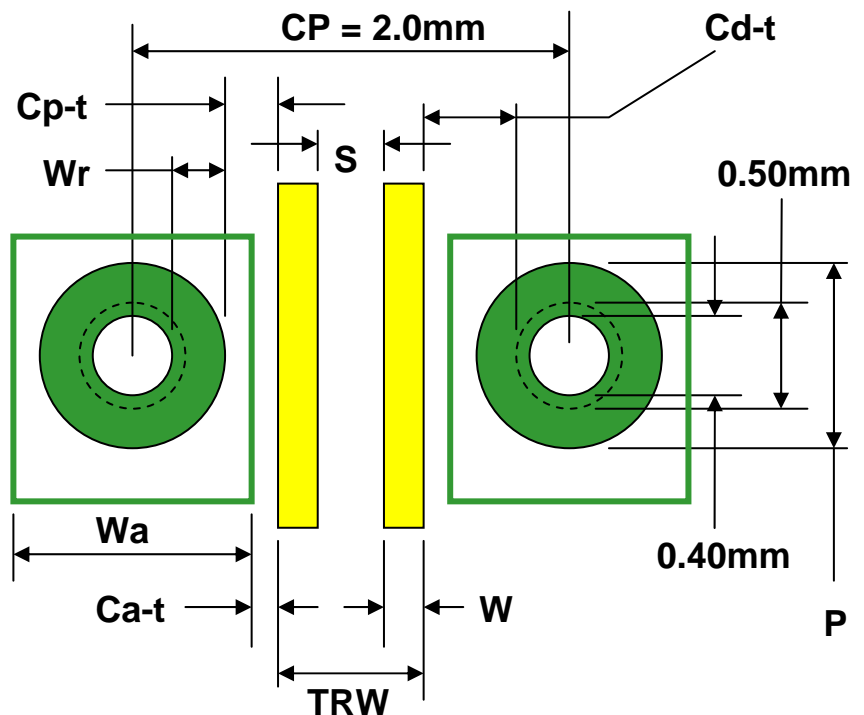



Figure 7: PCB Trace Routing Examples, 2mm Pitch Between Columns

This document is the property of and embodies CONFIDENTIAL and PROPRIETARY information of FCI. No part of the information shown on the document may be used in any way or disclosed to others without the written consent of FCI. Copyright FCI.

NUMBER GS-20-0305	TYPE Application Specification		
TITLE AirMax VSe® / VS2® Connector System, right angle press-fit products		PAGE 10 of 16	REVISION B
		AUTHORIZED BY Tao Zhan	DATE 2014-04-23
		CLASSIFICATION UNRESTRICTED	

5.6 BACK DRILLING

Back drilling is a method used by system designers that reduces the length of a conductive via which will improve high speed signal integrity performance. When back drilling is performed it is important to avoid damaging the portion of the via that makes contact with any press-fit tails. See below for recommendations on proper back drilling.

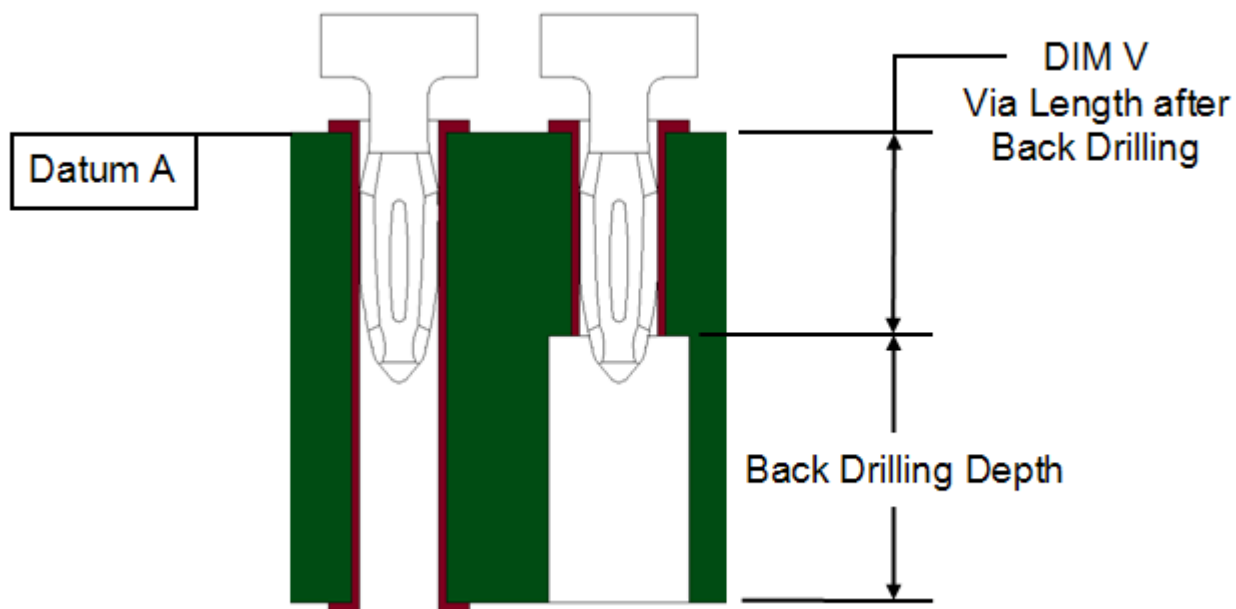



Figure 8: View of Back Drilling

After a back drilling operation, the remaining via barrel length (Dim V) must be at least 1.2mm for the signal terminals to ensure a reliable connection between the press-fit tails and the PCB. Assuming that the PCB manufacture can maintain a back drilling depth tolerance of $\pm 0.3\text{mm}$ relative to datum A, the nominal via length after back drilling would need to be 1.5mm.

6.0 APPLICATION TOOLING

6.1 CONNECTOR INSERTION TOOLING

The AirMax VSe® / VS2® connectors are designed for “flat rock” insertion and thus do not require any special insertion tooling. If the connector’s ground tails are longer than the thickness of the daughter card that the connector is being applied to (ground tail length specification is $1.60 \pm 0.15\text{mm}$) a special bottom support tool will be necessary. This tool could be a PCB with oversized holes or a custom tool designed by the user.

NUMBER GS-20-0305	TYPE Application Specification		
TITLE AirMax VSe [®] / VS2 [®] Connector System, right angle press-fit products		PAGE 11 of 16	REVISION B
		AUTHORIZED BY Tao Zhan	DATE 2014-04-23
		CLASSIFICATION UNRESTRICTED	

6.2 INSERTION PRESSES

Several important items to consider when selecting an insertion press include:

- The press must have sufficient force capabilities to insert the specific receptacle configuration.
- The press ram should be sufficiently long to cover the Press Block tooling to prevent tooling flex.
- The press table should be large enough to properly accommodate the PCB size.

Typical press types include:

- Manual arbor press
- Pneumatic press
- Hydraulic press
- Servo driven electronic press

Although the connector can be applied using any of the press types mentioned above the preferred press type is the servo driven electronic press. This press gives the best control during the insertion process and offers the most flexibility. An example of this type of press would be ASG's BMEP-5T.

7.0 RECOMMENDED INSERTION FORCES

The recommended maximum insertion force is 30 Newton per standard press-fit terminal, and 15 Newton per small press-fit terminal. The maximum insertion force per connector is found by taking the total number of contacts in the connector assembly and multiplying it times the 30 N or 15N maximum requirements. Refer to the example below.

EXAMPLE: For a 150 position AirMax VSe[®] connector there are 150 press-fit tails being inserted into the PC board. Therefore, the maximum recommended press setting would be 3000 N ((100 small press-fit tails x 15 N) + (50 standard press-fit tails x 30N)).

This maximum force recommendation has been determined to yield acceptable insertion results for PCB holes within FCI's recommended guidelines. While it is acceptable to use a lower insertion force per press-fit pin, steps should be taken to guarantee that the connector is seated properly (see Section 9). Force settings may vary with different types of PTH finishes. Customers should develop parameters that best suit individual application requirements.

NUMBER GS-20-0305	TYPE Application Specification		
TITLE AirMax VSe [®] / VS2 [®] Connector System, right angle press-fit products		PAGE 12 of 16	REVISION B
		AUTHORIZED BY Tao Zhan	DATE 2014-04-23
		CLASSIFICATION UNRESTRICTED	

8.0 APPLICATION PROCEDURE

The application procedure is as follows:

Note: The right angle receptacle has been shown in the illustrations below however the same procedure also applies for the right angle header.

- Place the connector assembly in the desired location on the daughter card taking care to assure that all press-fit tails line up with the proper holes.

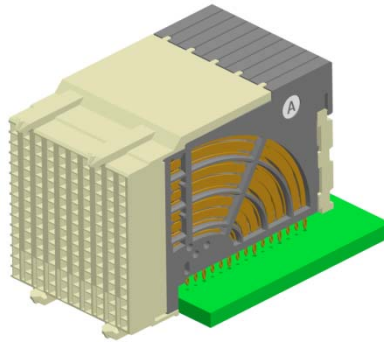

- Using a flat rock surface and an insertion press, apply force to the flat area of the connector as shown in the picture below. Actuation of the press should be slow and controlled, not fast like a punch press. Inserting to a specified force will yield more consistent results than inserting to a set distance. To ensure proper insertion, connectors must be centered beneath the press ram. An offset in the loading may result in improper seating of the connector.

NUMBER GS-20-0305	TYPE Application Specification		
TITLE AirMax VSe [®] / VS2 [®] Connector System, right angle press-fit products		PAGE 13 of 16	REVISION B
		AUTHORIZED BY Tao Zhan	DATE 2014-04-23
		CLASSIFICATION UNRESTRICTED	

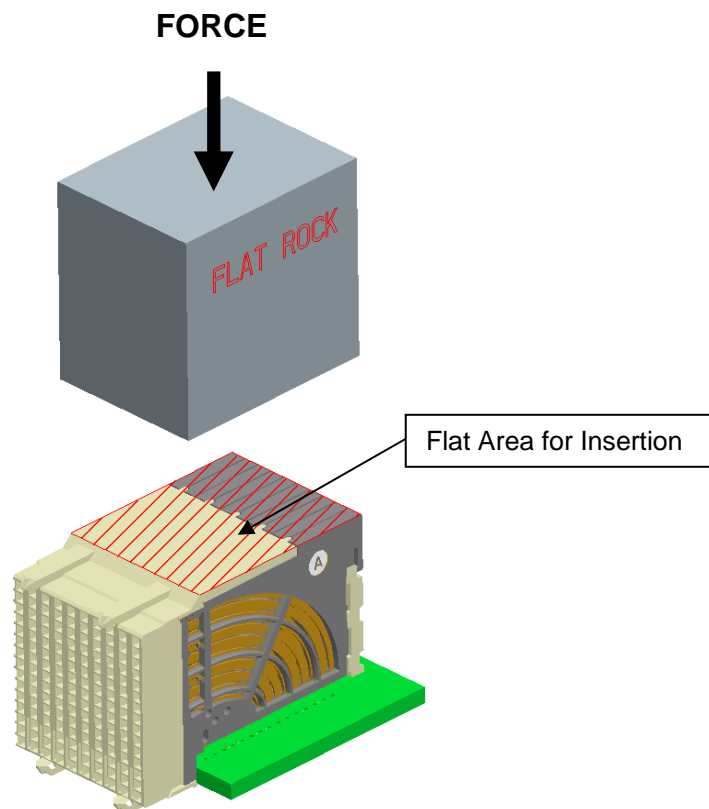

- Remove the connector assembly and inspect for proper application (refer to section 9.0).

9.0 POST-APPLICATION INSPECTION PROCEDURES

The Post-application inspection should consist of several simple checks to assure that the connector is applied properly and is not damaged.

- Visually assure that all press-fit tails are seated in the proper PCB holes and that none have been crushed during application.
- For right angle products, visually assure that the metal standoffs on the bottom of each assembly are seated within 0.10 mm of flush to the PCB. Inspect the IMLA retainer for a maximum clearance to the board of 0.10mm (see Figure 9). A larger gap beneath the standoffs or retainer may indicate that the connector is not seated fully or is not seated parallel to the board. This can cause misalignment when the daughter card is mated to the backplane.

NUMBER GS-20-0305	TYPE Application Specification	FCI	
TITLE AirMax VSe [®] / VS2 [®] Connector System, right angle press-fit products		PAGE 14 of 16	REVISION B
		AUTHORIZED BY Tao Zhan	DATE 2014-04-23
		CLASSIFICATION UNRESTRICTED	

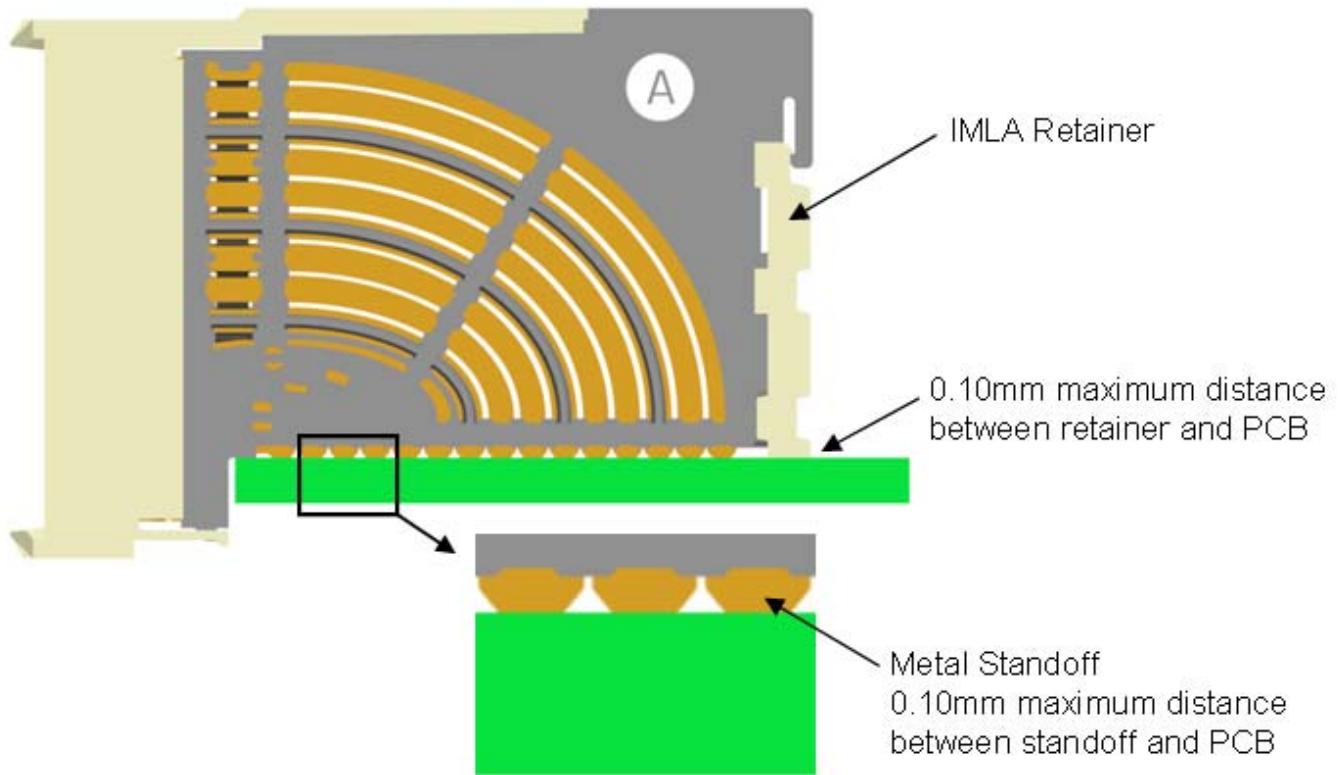



Figure 9: Proper Seating after Board Application

NUMBER GS-20-0305	TYPE Application Specification		
TITLE AirMax VSe [®] / VS2 [®] Connector System, right angle press-fit products		PAGE 15 of 16	REVISION B
		AUTHORIZED BY Tao Zhan	DATE 2014-04-23
		CLASSIFICATION UNRESTRICTED	

10.0 CONNECTOR REMOVAL TOOLING

The following are FCI removal tool part numbers for AirMax VSe[®] / VS2[®] connectors. The referenced FCI Manual describes proper connector removal procedures for each type of connector.

R/A Receptacle type	Column pitch, mm	Removal tool part no. *	FCI manual no.
150-position (5 pair)	2	10118159	430284
120-position (4 pair)	2	10118160	
54-position (3 pair)	2	10118161	

R/A Header type	Column pitch, mm	Removal tool part no. *	FCI manual no.
54-position (3 pair)	2	10119395	430294

*** To minimize costs the largest removal tool for a given column pitch may be used to remove any connector with that column pitch by disassembling the tool and removing pins as necessary.**

For some connector configurations it may be possible to use multiple repair methods. All recommended methods for repair will be described in the FCI manuals listed above.

NUMBER GS-20-0305	TYPE Application Specification		
TITLE AirMax VSe® / VS2® Connector System, right angle press-fit products		PAGE 16 of 16	REVISION B
		AUTHORIZED BY Tao Zhan	DATE 2014-04-23
		CLASSIFICATION UNRESTRICTED	

11.0 RECORD RETENTION

REV	PAGE	DESCRIPTION	EC #	DATE
A	ALL	Release Application Spec.		2013-07-22
B	7, 8,12	Add VS2 in table 5, change the insertion force		2014-04-23

This document is the property of and embodies CONFIDENTIAL and PROPRIETARY information of FCI. No part of the information shown on the document may be used in any way or disclosed to others without the written consent of FCI. Copyright FCI.