

923-ST1NET-FC

FLOW COMPUTER



Flowmetrics, Inc.

"Where Quality is Measurable"

9201 Independence Avenue • Chatsworth, CA 91311
(818) 407-3420 • FAX (818) 700-1961

Proprietary Notice

The information contained in this publication is derived in part from proprietary and patent data. This information has been prepared for the expressed purpose of assisting operating and maintenance personnel in the efficient use of the instrument described herein. Publication of this information does not convey any rights to use or reproduce it or to use for any purpose other than in connection with the installation, operation and maintenance of the equipment described herein.

Copyright 1999
Printed in USA. All Rights Reserved.



WARNING!

This instrument contains electronic components that are susceptible to damage by static electricity. Proper handling* procedures must be observed during the removal, installation, or handling of internal circuit boards or devices.

*Handling Procedure

1. Power to unit must be removed.
2. Personnel must be grounded, via wrist strap or other safe, suitable means, before any printed circuit board or other internal device is installed, removed or adjusted.
3. Printed circuit boards must be transported in a conductive bag or other conductive container. Boards must not be removed from protective enclosure until the immediate time of installation. Removed boards must be placed immediately in protective container for transport, storage, or return to factory.

Comments

This instrument is not unique in its content of ESD (electrostatic discharge) sensitive components. Most modern electronic designs contain components that utilize metal oxide technology (NMOS, CMOS, etc.). Experience has proven that even small amounts of static electricity can damage or destroy these devices. Damaged components, even though they appear to function properly, may exhibit early failure.



SAFETY INSTRUCTIONS

The following instructions must be observed.

- This instrument was designed and is checked in accordance with regulations in force EN 60950 ("Safety of information technology equipment, including electrical business equipment"). A hazardous situation may occur if this instrument is not used for its intended purpose or is used incorrectly. Please note operating instructions provided in this manual.
 - The instrument must be installed, operated and maintained by personnel who have been properly trained. Personnel must read and understand this manual prior to installation and operation of the instrument.
 - This instrument is internally fused. Replace the internal fuse with the following specified type and rating only:

Input Power	Recommended Fuse
115 VAC	160 mA slow blow fuse
230 VAC	80 mA slow blow fuse
12-24 VDC	800 mA slow blow fuse
- Disconnect power supply before replacing fuse!**
- The manufacturer assumes no liability for damage caused by incorrect use of the instrument or for modifications or changes made to the instrument.

Symbols Used On Unit

<u>Number</u>	<u>Symbol</u>	<u>Publication</u>	<u>Description</u>
1	==	IEC 417, No. 5031	Direct current
2		IEC 417, No. 5172	Equipment protected throughout by DOUBLE INSULATION or REINFORCED INSULATION (equivalent to Class II of IEC 536—see annex H)
3		ISO 3864, No. B.3.1	Caution (refer to accompanying documents)

Technical Improvements

- The manufacturer reserves the right to modify technical data without prior notice.

CONTENTS

1. DESCRIPTION

1.1 Unit Description.....	1
1.2 Unit Features.....	1
1.3 Specifications.....	2

2. INSTALLATION

2.1 General Mounting Hints	6
2.2 Mounting Diagrams	6

3. APPLICATIONS

3.1 Net Liquid Volume	7
3.2 Net Corrected Liquid Volume	8
3.3 Net Liquid Mass	9

4. WIRING

4.1 Typical Wiring.....	10
4.2 Wiring In Hazardous Areas	11

5. UNIT OPERATION

5.1 Front Panel Operation Concept for Run Mode.....	12
5.2 General Operation.....	13
5.3 Ratemeter/Totalizer Operation	13
5.3.1 Password Protection for Rate/Total mode	13
5.3.2 Relay Operation in Rate/Total mode.....	13
5.3.3 Pulse Output in Rate/Total mode	13
5.3.4 Analog Output in Rate/Total mode	13
5.3.5 RS-232 Serial Port Operation in Rate/Total mode	14
5.3.6 RS-485 Serial Port Operation in Rate/Total mode	14

6. PROGRAMMING

6.1 Front Panel Operation Concept for Program Mode	15
6.2 Setup Menus.....	16
6.3 Setup Sub-Menus	17
6.3.1 SELECT FLOW EQUATION	17
6.3.2 SETUP INDICATORS (Total).....	17
6.3.3 SETUP INDICATORS (Density).....	17
6.3.4 SETUP INDICATORS (Rate)	18
6.3.5 SETUP INDICATORS (Temperature)	18
6.3.6 SETUP FLOW INPUT	19
6.3.7 SETUP AUX1 INPUT	21
6.3.8 SETUP AUX2 INPUT	22
6.3.9 SET FLUID PROPERTIES	23
6.3.10 SETUP PULSE OUTPUT	24
6.3.11 SETUP ANALOG OUTPUT.....	24
6.3.12 SETUP RELAYS	25
6.3.13 SETUP CONTROL INPUTS	27
6.3.14 SETUP REALTIME CLOCK(Time).....	28
6.3.15 SETUP REALTIME CLOCK(Date).....	28
6.3.16 SERIAL USAGE (RS-232/485)	29
6.3.17 SERIAL USAGE (Modem Options).....	29
6.3.18 SET DATALOG/PRINT(Configure)	30
6.3.19 SET DATALOG/PRINT (Select_list).....	31
6.3.20 ADMINISTRATIVE SETUP	31
6.3.21 SETUP NETWORK CARD	32

7. PRINCIPLE OF OPERATION

7.1 General	33
7.2 Flow Equations.....	33
7.3 Calculating the Expansion Factor	36
7.4 Computation of Viscosity Coef. A and B.....	37
7.5 Linearization Table	38
7.5.1 Linearization Table General Information	38
7.5.2 Linearization Table for Pulse Inputs.....	38
7.5.3 Linearization Table Interpolation	38
7.6 Universal Viscosity Curve (UVC)	38
7.7 Strouhal Roshko Curve (StRo).....	38

CONTENTS

8. TEST, SERVICE and MAINTENANCE

8.1 Test Menus	39
8.2 Test Sub-Menus	40
8.2.1 Audit Trail	40
8.2.2 Error History	40
8.2.3 Print System Setup	40
8.2.4 Keypad test	41
8.2.5 Display test	41
8.2.6 Calibrate Aux1 0mA	42
8.2.7 Calibrate Aux1 20mA	42
8.2.8 Calibrate Aux2 0mA	43
8.2.9 Calibrate Aux2 20mA	43
8.2.10 Calibrate Thermistor: 100 Ohms	44
8.2.11 Calibrate Thermistor: Open	44
8.2.12 Calibrate Aux2 0V	45
8.2.13 Calibrate Aux2 10V	45
8.2.14 Calibrate 100 ohm RTD	45
8.2.15 Calibrate 4mA Out	46
8.2.16 Calibrate 20mA Out	46
8.2.17 Analog In Test	46
8.2.18 Pulse input test	47
8.2.19 Analog out test	47
8.2.20 Excitation out test	47
8.2.21 Pulse out test	48
8.2.22 Relay test	48
8.2.23 Control input test	48
8.2.24 Battery Voltage test	49
8.2.25 Data logger utility	49
8.3 Internal Fuse Replacement	50

9. RS-232 SERIAL PORT

9.1 RS-232 Serial Port Description	51
9.2 Instrument Setup by PC Over Serial Port	51
9.3 Operation of Serial Communication Port with Printers	51
9.4 923-ST1NET-FC RS-232 Port Pinout	51

10. RS-485 SERIAL PORT

10.1 RS-485 Serial Port Description	52
10.2 General	52
10.3 Operation of Serial Communication Port with PC	52
10.4 923-ST1NET-FC RS-485 Port Pinout	52

11. FLOW COMPUTER SETUP SOFTWARE

11.1 System Requirements	53
11.2 Cable and Wiring Requirements	53
11.3 Installation for Windows™	53
11.4 Using the Flow Computer Setup Software	54
11.5 File Tab	54
11.6 Setup Tab	54
11.7 View Tab	55
11.8 Misc. Tab	55

12. GLOSSARY OF TERMS

12 Glossary Of Terms	57
----------------------------	----

13. DIAGNOSIS AND TROUBLESHOOTING

13.1 Response of 923-ST1NET-FC on Error or Alarm:	60
13.2 Diagnosis Flow Chart and Troubleshooting	61
13.3 Error & Warning Messages:	62
13.3.1 Sensor/Process Alarms	62
13.3.2 Self Test Alarms	63

APPENDIX A (FLUID PROPERTIES TABLE)	64
--	----

APPENDIX B (Setup Menus)	65
---------------------------------------	----

APPENDIX C (RS485 Modbus RTU Protocol)	66
---	----

Unit Description**1. Description****1.1 Unit Description:**

The 923-ST1NET-FC Flow Computer is a two channel flow computer intended for calculation of net flow (A - B) rate and total. It operates with pulse producing flowmeters in liquid applications. The unit displays the rate/total of the supply, return and net flows. Multiple flow equations and instrument functions are available in a single unit with many advanced features. Volume Flow, Corrected Volume Flow or Mass Flow calculations can be selected.

The alphanumeric display shows measured and calculated parameters in easy to understand format. Single key direct access to measurements and display scrolling is supported

The 923-ST1NET-FC offers a wide measure of versatility within the instrument package. The various hardware inputs and outputs can be “soft” assigned to meet a variety of common application needs. The user “soft selects” the usage of each input/output while configuring the instrument.

The excitation voltage, input termination and input filtering are chosen by means of a menu selection.

The user can assign the standard RS-232 Serial Port for data recording, transaction printing, or for connection to a computer.

Menu selectable linearization options include UVC, Strouhal/Roshko and 40 point linearization tables.

A Service or Test mode is provided to assist the user during start-up system check out by monitoring inputs and exercising outputs and printing system setup.

An auxiliary energy totalizer is available as a special order option.

Unit Features**1.2 Unit Features:**

The 923-ST1NET-FC Flow Computer offers the following features:

- Supports Pulse Producing Flowmeters
- Displays Supply, Return and Net Rate/Total
- Universal Viscosity Curve (UVC) and Strouhal/Roshko Advanced Linearization Methods for Turbine Flowmeters
- API 2540 Equations for Petroleum Fluids
- User Entry of Fluid Properties for 10 Selectable Fluids
- Menu Selectable Hardware & Software Features
- Data Logging of Net Rate/Total
- Two Line LCD or VFD Display
- Isolated Pulse and Analog Outputs Standard
- RS-232 Port Standard, RS-485 Modbus RTU Optional
- Auxiliary Energy Totalizer Available on Special Order
- Windows™ Setup Software
- DDE Server, HMI and Remote Metering Software Available

1.3 Specifications:

Specifications:

Flow Meters and Computations

Meter Types: Supports pulse producing meters including: vortex, single rotor turbine, magnetic, PD flowmeter, Coriolis

Linearization: 40 point table, UVC table or Strouhal/Roshko

Computations: Volume, Corrected Volume & Mass
Fluid Computations: Density, Viscosity, Independently in the Supply and Return lines.

Environmental

Operating Temperature: 0°C to +50°C

Storage Temperature: -40°C to +85 C

Humidity : 0-95% Non-condensing

Materials: U.L. approved

Approvals: CE Compliant, UL/CUL Listed

Display

Type: 2 lines of 20 characters, Blue VFD or Backlit LCD

Character Size: 0.3" nominal

User programmable label descriptors and units of measure

Keypad

Keypad Type: Membrane Keypad with 16 keys

Keypad Rating: Sealed to Nema 4

Enclosure

Size: See Dimensions

Depth behind panel: 6.5" including mating connector

Type: DIN

Materials: Plastic, UL94V-0, Flame retardant

Bezel: Textured per matt finish

Fluid Types

General Purpose, User entry of fluid properties for up to 10 fluids.

Real Time Clock

The 923-ST1NET-FC is equipped with a battery backed real time clock with display of time and date.

Format:

12 or 24 hour time display

Day, Month, Year date display

Excitation Voltage

Menu Selectable: 5, 12 or 24 VDC @ 100 mA (fault protected with self resetting fuse) on AC units.

DC units have limited selections.

Relay Outputs

The relay outputs are menu assignable to (Individually for each relay) Low Net Flow Rate Alarm, High Net Flow Rate Alarm, High Net Total Alarm, Temperature 1, Temperature 2 or General purpose warning (security).

Number of relays: 2 (4 optional)

Contact Style: Form C contacts

Contact Ratings: 5 amp, 240 VAC or 30 VDC

Capabilities: Alarm Delay, Setpoint, Hysteresis, Duration

Power Input

The factory equipped power option is internally fused. An internal line to line filter capacitor and MOV are provided for added transient suppression.

110 VAC Power: 85 to 127 Vrms, 50/60 Hz

220 VAC Power: 170 to 276 Vrms, 50/60 Hz

DC Power:

12 VDC (10 to 14 VDC)

24 VDC (14 to 28 VDC)

Power Consumption:

AC: 11.0 VA (11W)

DC: 300 mA max.

Flow Inputs:

Pulse Inputs:

Number of Flow Inputs: 2, one for supply and one for return

Input Impedance: 10 K Ω nominal

Pullup Resistance: 10 K Ω to 5 VDC (menu selectable)

Pull Down Resistance: 10 K Ω to common

Trigger Level: (menu selectable)

High Level Input

Logic On: 3 to 30 VDC

Logic Off: 0 to 1 VDC

Low Level Input (mag pickup)

Sensitivity:

10 mV or 100 mV

Minimum Count Speed:

Menu selectable: 1-99 seconds

Maximum Count Speed:

Menu Selectable: 40Hz, 3000Hz or 20kHz

Overvoltage Protection: 50 VDC

Control Inputs

Switch Inputs are menu selectable for Reset, Lock, Inhibit, Alarm Acknowledge, Print, Aux. Energy Total Input or Not Used.

Control Input Specifications

Number of Control Inputs: 3

Input Scan Rate: 10 scans per second

Logic 1: 4 - 30 VDC

Logic 0: 0 - 0.8 VDC

Input Impedance: 100 K Ω

Control Activation:

Positive Edge or Pos. Level based on product definition for switch usage.

Auxiliary / Compensation Inputs

The auxiliary/compensation inputs are menu selectable for supply temperature, return temperature or not used. These inputs are used for the compensated inputs when performing compensated flow calculations. They can also be used as a general purpose input for display and alarming. Supply temperature can be used for both supply and return if selected.
Number of inputs: 2

Operation: Ratiometric
Accuracy: 0.02% FS at 20° C
Basic Measurement Resolution:
16 bit
Update Rate: 1 update/sec minimum
Automatic Fault detection:
Signal Over-range/under-range
Current Loop Broken
Fault mode to user defined default settings

Fault Protection:
Reverse Polarity: No ill effects

Available Input Ranges
Current: 4-20 mA, 0-20 mA (Ts & Tr)
Voltage: 0-5 V, 1-5 V, 0-10 V (Tr)
RTD: (One) 100Ω DIN RTD Standard 3 Wire (Ts)
Thermistor - Consult Factory (Ts)

Isolated Analog Output

The analog output corresponds to the Net Rate or Net Total
Type: Isolated Current Sourcing
Available Ranges: 4-20 mA, 0-20 mA
Resolution: 12 bit
Accuracy: 0.05% FS at 20° C
Update Rate: 1 update/sec minimum
Temperature Drift: Less than 200 ppm/C
Maximum Load: 1000 ohms (at nominal line voltage)
Compliance Effect: Less than .05% Span
60 Hz rejection: 40 dB minimum
Calibration: Operator assisted Learn Mode
Averaging: User entry of damping constant to cause a smooth control action

Isolated Pulse output

The isolated pulse output is assigned to follow the Net Total.
Pulse Output Form: Photo MOS Relay
Maximum On Current: 100 mA
Maximum Off Voltage: 30 VDC
Saturation Voltage: 1.0 VDC
Maximum Off Current: 0.1 mA
Pulse Duration: 10 mSec or 100 mSec (user selectable)
Pulse output buffer: 256
Fault Protection
Reverse polarity: Shunt Diode
Scaling: User entry

Serial Communication

The serial port can be used for printing, accessing datalog, live data recording, and/or communication with a computer.

RS-232:
Device ID: 01-99
Baud Rates: 300, 600, 1200, 2400, 4800, 9600, 19200
Parity: None, Odd, Even
Handshaking: None, Software, Hardware
Print Setup: Configurable print list and formatting
RS-485: (optional 2nd COM port)
Device ID: 01-247
Baud Rates: 2400, 4800, 9600, 19200
Parity: None, Odd, Even
Protocol: Modbus RTU (Half Duplex)

Setup Diskette Capabilities

Capabilities include: View Live Results Configure unit, Upload and Download configuration to unit, Load and Save to file, Print Setup,

Data Logging Capabilities

Capabilities:
Permits unit to automatically gather data during use.
Data Log List:
User selectable: includes Supply/Return Temperatures, Supply, Return and Net Ratemeters/Totalizers, Time and Date, plus other
Data Log Event Trigger:
selectable: includes interval, time of day, front key, external contact
Data Log Format:
selectable: Printer format, Database CSV format
Data Transmission:
Selectable: Output may be transmitted immediately or held in data log for later polling
Remote Request Capabilities include:
Send data log, clear data log

External Modem Support Capabilities:

Compatibility: Hayes Compatible
Polling Capabilities:
Answers incoming calls, responds to requests for information of action
Call Out Capabilities:
Can initiate call on user selectable event condition, or upon error
Error Handling:
Supports multiple retry, automatic disconnect upon loss of line or remote inactivity

Operating Mode

The Flow Computer can be thought of as making a series of measurements of the supply and return flow and temperature sensors and then performing calculations to arrive at a result(s) which is then updated periodically on the display. The analog output, the pulse output, and the alarm relays are also updated. The cycle then repeats itself.

Step 1: Update the measurements of input signals-
Raw Input Measurements are made at each input using equations based on input signal type selected. The system notes the "out of range" input signal as an alarm condition. The unit alternates between supply and return measurements.

Step 2: Compute the Flowing Fluid Parameters-
The temperature, viscosity, and density equations are computed as needed based on the flow equation and input usage selected by the user.

Step 3 : Compute the Volumetric Flow-
Uncompensated flow is the term given to the flow in volume units. The value is computed based on the flowmeter input type selected and augmented by any performance enhancing linearization that has been specified by the user.

Step 4: Compute the Corrected Volume Flow at Reference Conditions-
In the case of a corrected volume flow calculation, the supply, return and net corrected volume flows are computed as required by the selected compensation equation.

Step 5 : Compute the Mass Flow-
All required information is now available to compute the supply, return and net mass flow rates as volume flow times reference density.

Step 6: Check Flow Alarms-
The flow alarm functions have been assigned to either the net flow rate or temperatures during the setup of the instrument. A comparison is now made by comparing the current flow rates against the specified hi and low limits.

Step 7: Compute the Analog Output-
This net flow rate or net total value is now used to compute the analog output.

Step 8: Compute the individual Flow Totals by Summation-
A flow total increment is computed for each totalizer. The totalizer format also includes provisions for total rollover.

Step 9: Total Preset Comparisons-
The net total associated with a preset function is then compared against the corresponding preset value and any required control actions taken.

Step 10: Pulse Output Service-
The pulse output is next updated by scaling the net total increment which has just been determined by the pulse output scaler and summing it to any residual pulse output amount.

Step 11: Update Display and Printer Output-
The instrument finally runs a task to update the various table entries associated with the front panel display and serial outputs.

Setup Mode

The setup mode is password protected by means of numeric operator and supervisor lock out codes established by the user. In addition, a secret, manufacturers numeric unlock entry sequence is available. A jumper on Control Input 3 can also prevent access.

The system also provides a minimum implementation of an "audit trail" which tracks significant setup changes to the unit. This feature is increasingly being found of benefit to users or simply required by Weights and Measurement Officials in systems used in commerce, trade, or "custody transfer" applications.

A software program is also available which runs on a PC using a RS-232 Serial for connection to the Flow Computer. Illustrative examples may be downloaded in this manner.

The setup mode has numerous subgrouping of parameters needed for flow calculations. There is a well conceived hierarchy to the setup parameter list. Selections made at the beginning of the setup affect offerings further down in the lists.

In the setup mode, the flow computer activates the correct setup variables based on the instrument configuration, the flow equation, and the hardware selections made for the compensation transmitter type, the flow transmitter type, and meter enhancements (linearization) options selected. All required setup parameters are enabled. All setup parameters not required are suppressed.

A help line prompt is provided for each entry. In addition a help message is available which may be accessed by depressing the "HELP" key.

Also note that in the setup mode are parameter selections which have preassigned industry standard values. The unit will assume these values unless they are modified by the user.

Most of the process input variables have available a "default" or emergency value which must be entered. These are the values that the unit assumes when a malfunction is determined to have occurred on the corresponding input.

It is possible to enter in a nominal constant value for temperature or density by placing the desired nominal value into both the lo and hi values. This is also a convenience when performing bench top tests without simulators.

Maintenance (Test) Mode:

The Maintenance Mode of the 923-ST1NET-FC is the Test and Calibration Mode for the device. This mode provides a number of specialized utilities required for factory calibration, instrument checkout on start-up, and periodic calibration documentation.

A supervisor password is required to gain access to this specialized mode of operation. Normally quality, calibration, and maintenance personnel will find this mode of operation very useful. It is also useful for factory testing.

Many of these tests may be used during start-up of a new system. Inputs signals may be read, and output signals may be exercised to verify the electrical interconnects before the entire system is put on line.

The following action items may be performed in the Maintenance Mode:

- Print Calibration/Maintenance Report
- Examine Audit Trail
- Perform Keypad Checkout
- Perform Display Checkout
- Perform Pulse Input Checkout
- Perform Pulse Output Checkout
- Perform Control Input Checkout
- Perform Relay Output Checkout
- Perform Analog Input Checkout
- Perform Analog Output Checkout
- Calibrate Analog Inputs using the Learn Feature
- Calibrate Analog Output using the Learn Feature
- Battery Check
- Datalog Printing and Clearing

Note that a calibration of the analog input/output will advance the audit trail counters since it effects the accuracy of the system.

RS-232 Serial Port

The 923-ST1NET-FC has a general purpose RS-232 Port which may be used for any one of the following purposes:

- Transaction Printing
- Periodic Printing of Datalog
- Print Internal Datalog
- Remote Metering by Modem (optional)
- Computer Communication Link
- Configuration by Computer
- Print System Setup
- Print Calibration/Malfunction History
- Remote Control

Instrument Setup by PC's over Serial Port

A Setup program is provided with the 923-ST1NET-FC that enables the user to rapidly configure the 923-ST1NET-FC using a Personnel Computer. Included in the setup software are common instrument applications which may be used as a starting point for your application. This permits the user to have an excellent starting point and helps speed the user through the instrument setup.

Operation of Serial Communication Port with Printers

923-ST1NET-FC's RS-232 channel supports a number of operating modes. One of these modes is intended to support operation with a printer in metering applications requiring transaction printing, data logging, and/or printing of calibration and maintenance reports.

For transaction printing, the user defines the items to be included in the printed document. The user can also select what initiates the transaction print generated as part of the setup of the instrument. The transaction document may be initiated via a front panel key depression, a remote contact closure.

In data logging, the user defines the items to be included in each data log as a print list. The user can also select when or how often he wishes a data log to be made. This is done during the setup of the instrument as either a time of day or as a time interval between logging.

The system setup and maintenance report lists all the instrument setup parameters and usage for the current instrument configuration. In addition, the Audit trail information is presented along with a status report listing any observed malfunctions which have not been corrected.

The user initiates the printing of this report at a designated point in the menu by pressing the print key on the front panel.

Operation of Serial Port with Modems (optional)

The 923-ST1NET-FC RS-232 channel supports a number of operating modes. One of these modes is intended to support operation with a modem in remote metering applications.

An external modem is intentionally being used with the 923-ST1NET-FC. This permits use with the variety of modem standards worldwide while avoiding the specialized approvals required for equipment that is deemed to fall under the category of telecommunication equipment.

In the modem mode, the 923-ST1NET-FC is assumed to be operating in a remote metering role. The 923-ST1NET-FC will support key items in the Hayes Compatible "AT" Command Set. In this role, the 923-ST1NET-FC will have the following special abilities:

0. Monitor the modem status as a task of the system
1. Instruct the modem to answer an incoming call ATA
2. Respond to the calling modem at the programmed baud rate and protocol
3. Terminate the telephone connection in event the connection is lost.

In addition, the 923-ST1NET-FC is capable of initiating a call to a designated telephone number in the event of a metering malfunction. Consult factory for additional details on remote metering software.

2. Installation

General Mounting Hints

2.1 General Mounting Hints:

The 923-ST1NET-FC Flow Computer should be located in an area with a clean, dry atmosphere which is relatively free of shock and vibration. The unit is installed in a 5.43" (138mm) wide by 2.68" (68mm) high panel cutout. (see Mounting Dimensions) To mount the Flow Computer, proceed as follows:

Mounting Procedure

- a. Prepare the panel opening.
- b. Slide the unit through the panel cutout until the it touches the panel.
- c. Install the screws (provided) in the mounting bracket and slip the bracket over the rear of the case until it snaps in place.
- d. Tighten the screws firmly to attach the bezel to the panel. 3 in. lb. of torque must be applied and the bezel must be parallel to the panel.

Termination Connectors:

- Minimum Wire Gauge: 22 AWG
- Maximum Wire Gauge: 14 AWG
- Voltage/current limits are limited by unit specifications.

Permanently Connected Equipment:

UL 3101-1, Section 6.12.2.1 specifies that:

- A switch or circuit breaker shall be included in the building installation;
- It shall be in close proximity to the equipment and within easy reach of the OPERATOR;
- It shall be marked as the disconnecting device for the equipment.

Ensure that the switch or circuit breaker chosen is suitable for the power requirements of the unit.



NOTE:

Bezel Adaptor Instructions:

To provide protection type IP65/NEMA 4X, the unit has to be mounted with the bezel adaptor and the gasket (supplied with the mounting kit). The bezel has to be glued to the unit with silicon (see Figure below)

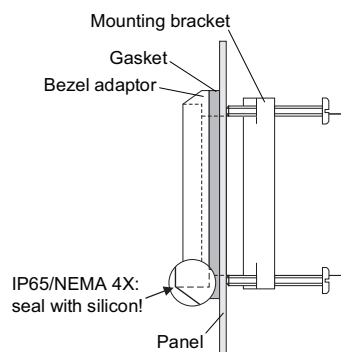

2.2 Mounting Diagrams:

<h5 style="text-align: center;">Standard Mounting</h5> <p style="text-align: center;">Flow Computer Mounting Bracket</p>	<h5 style="text-align: center;">Bezel Kit Mounting</h5> <p style="text-align: center;">Flow Computer Bezel Adaptor Gasket Mounting Bracket</p>
<h5>Dimensions</h5> <p style="text-align: center;">Dotted Line Shows Optional Bezel Kit</p> <p style="text-align: center;">Dimensions are in inches (mm)</p>	

3. Applications

Net Liquid Volume

3.1 Net Liquid Volume

Measurements:

Flowmeter sensors measure the actual volume in the supply and return liquid lines. A temperature sensor can also be installed to correct for UVC or STRO linearization of turbine flowmeters. Coriolis flowmeters will typically use this equation for mass flow as well.

Calculations:

- Supply and return volume flow is calculated using the flowmeter frequency output and the user entered K-Factor.

$$\text{Net Flow} = \text{Supply Flow} - \text{Return Flow}$$

Output Results:

- Display Results
 Supply, Return, Net Flow Rates, Resettable Totals, Non-Resettable Totals
- Analog Output
 Net Rate or Net Total
- Pulse Output
 Net Total
- Relay Outputs
 Net Rate or Net Total Alarms

Applications:

The Flow Computer can monitor actual net volume flow and total of any liquid. (Common applications include boiler and diesel engine fuel consumption measurement) Flow alarms are provided via relays and datalogging is available via analog (4-20mA) and serial outputs.

Net Liquid Volume Illustration

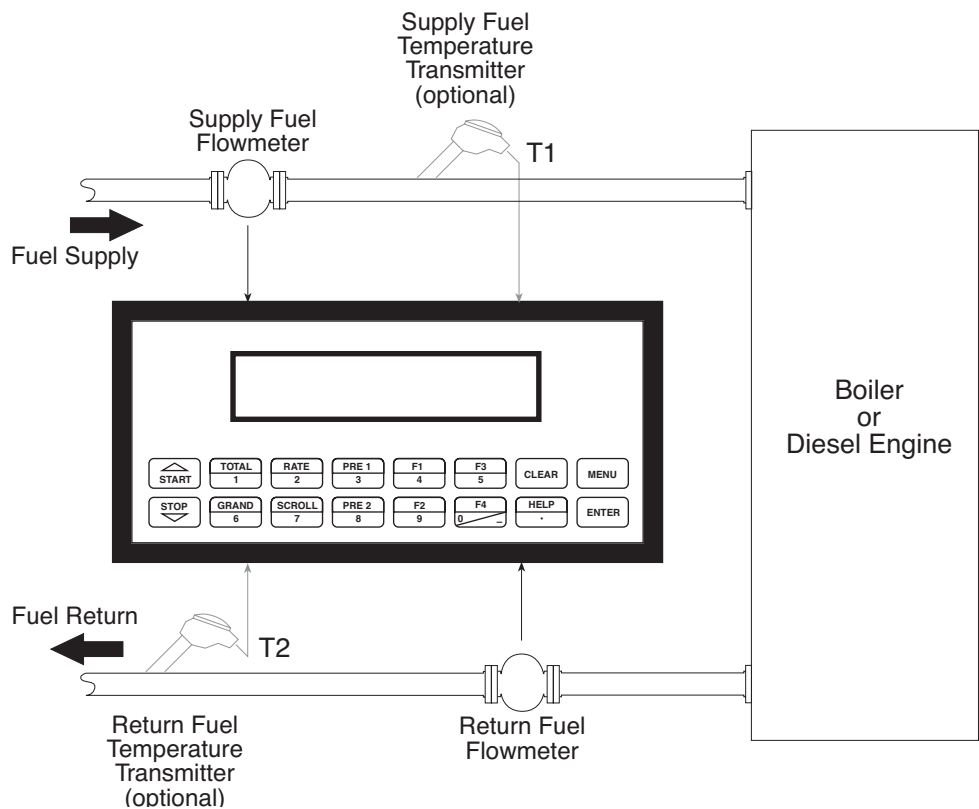

Calculations

Pulse Input; Average K-Factor

$$\text{Supply or Return Volume Flow} = \frac{\text{input frequency} \cdot \text{time scale factor}}{\text{K-Factor}}$$

$$\text{Net Flow} = \text{Supply Flow} - \text{Return Flow}$$

Net Corrected Liquid Volume

3.2 Net Corrected Liquid Volume

Measurements:

Flowmeter sensors measure the actual volume in the supply and return liquid lines. A temperature sensor is installed to correct for liquid thermal fluid expansion in each line as well as optional UVC or STRO linearization of turbine flowmeters.

Calculations:

- Supply and Return Corrected Volume at a base or reference condition is calculated using the respective flow and temperature inputs as well as the thermal fluid expansion coefficient stored in the flow computer. Use the "SET FLUID PROPERTIES" submenu to define reference temperature and density values for standard conditions.

$$\text{Net Flow} = \text{Supply Flow} - \text{Return Flow}$$

Output Results:

- Display Results
 Supply, Return, Net Corrected Flow Rates, Resettable Totals, Non-Resettable Totals, Temperatures, Densities
- Analog Output
 Net Corrected Rate or Total
- Pulse Output
 Net Corrected Total
- Relay Outputs
 Net Corrected Rate , Total or Temperature Alarms

Applications:

Monitoring corrected volume flow and total of any liquid. (Common applications include boiler and diesel engine fuel consumption measurement) Flow alarms are provided via relays and datalogging is available via analog (4-20mA) and serial outputs.

Net Corrected Liquid Volume Illustration

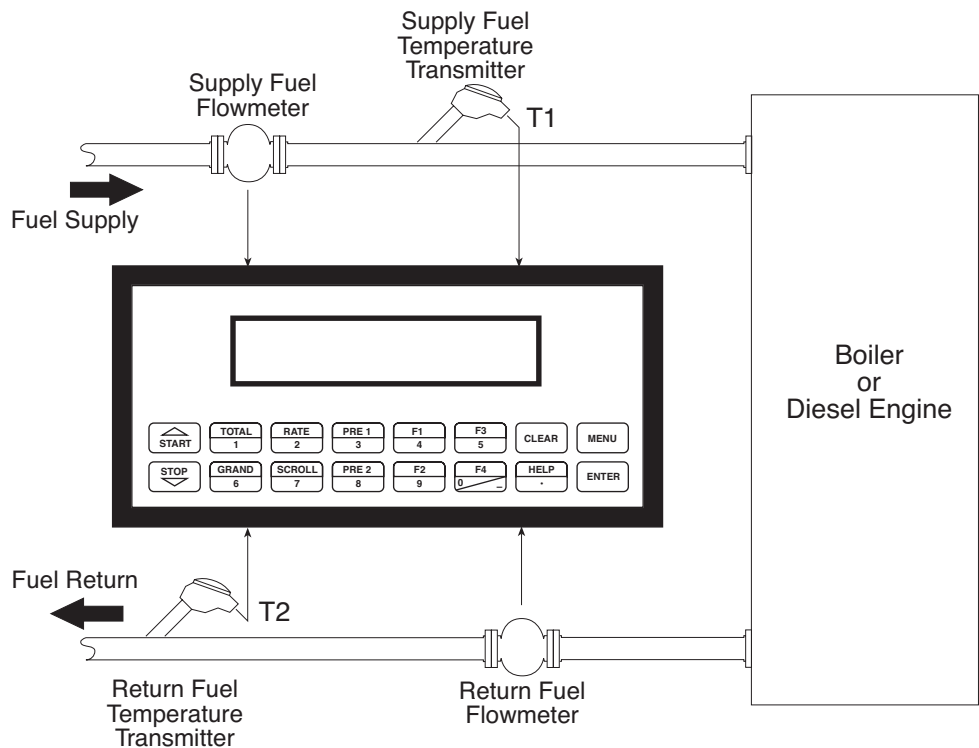

Calculations

Supply and Return Volume Flows

As calculated in section 3.1

Corrected Volume Flow (Temp. Transmitter)

Supply/Return Corrected Vol. Flow = vol. flow * (1 - Therm.Exp.Coef. *(Tf-Tref))²
 (See also API 2540 equation)

Net Corrected Flow = Supply Corrected Flow – Return Corrected Flow

Net Liquid Mass

3.3 Net Liquid Mass

Measurements:

Supply and return actual volumes are measured by the respective flow element. Supply and return temperatures are measured by the supply and return temperature transmitters.

Calculations:

- The density and mass flow are measured directly or calculated using the reference density and the thermal expansion coefficient of the liquid as well as optional UVC or STRO linearization of turbine flowmeters (see "SET FLUID PROPERTIES" submenu)

Output Results:

- Display Results
Supply, Return, Net Mass Flow Rates, Resettable Totals, Non-Resettable Totals, Temperatures, Densities
- Analog Output
Net Mass Rate, Total
- Pulse Output
Net Mass Total
- Relay Outputs
Net Mass Flow Rate, Total, Temperature or Alarms

Applications:

Monitoring of net mass flow and total of any liquid. (Common applications include boiler and diesel engine fuel consumption measurement) Flow alarms are provided via relays and datalogging is available via analog (4-20mA) and serial outputs.

Net Liquid Mass Illustration

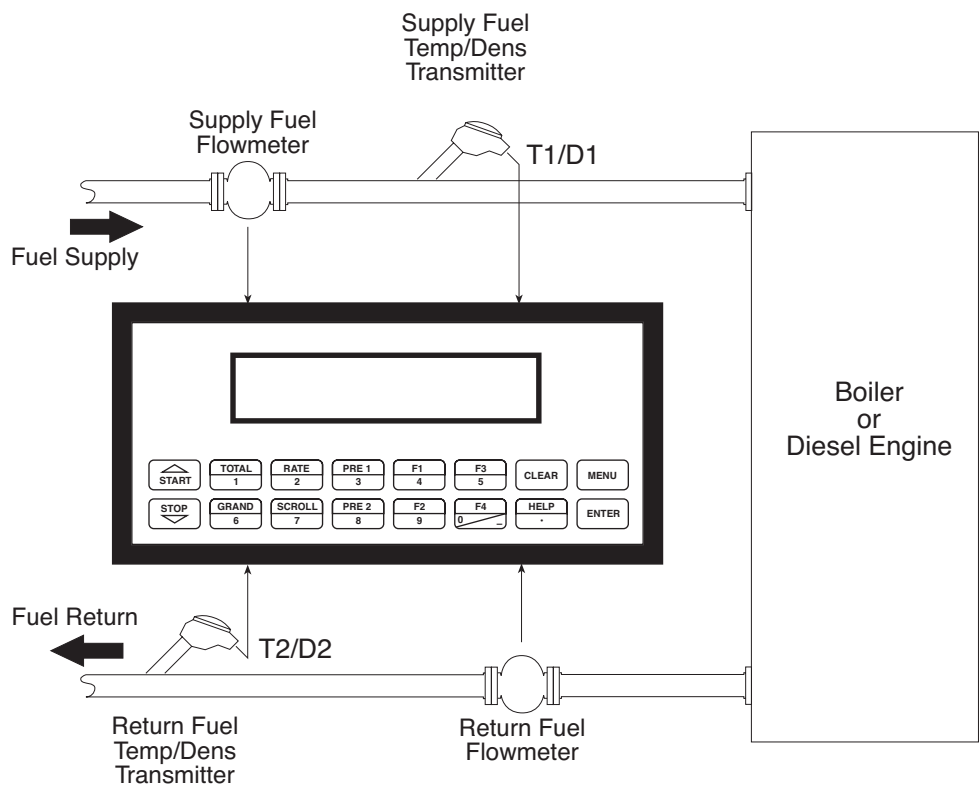

Calculations

Supply and Return Volume Flows

As calculated in section 3.1

Mass Flow

$$\text{Net Mass Flow} = (\text{supply volume flow} * \text{supply density}) - (\text{return volume flow} * \text{return density})$$

4 WIRING

4.1 Typical Wiring:

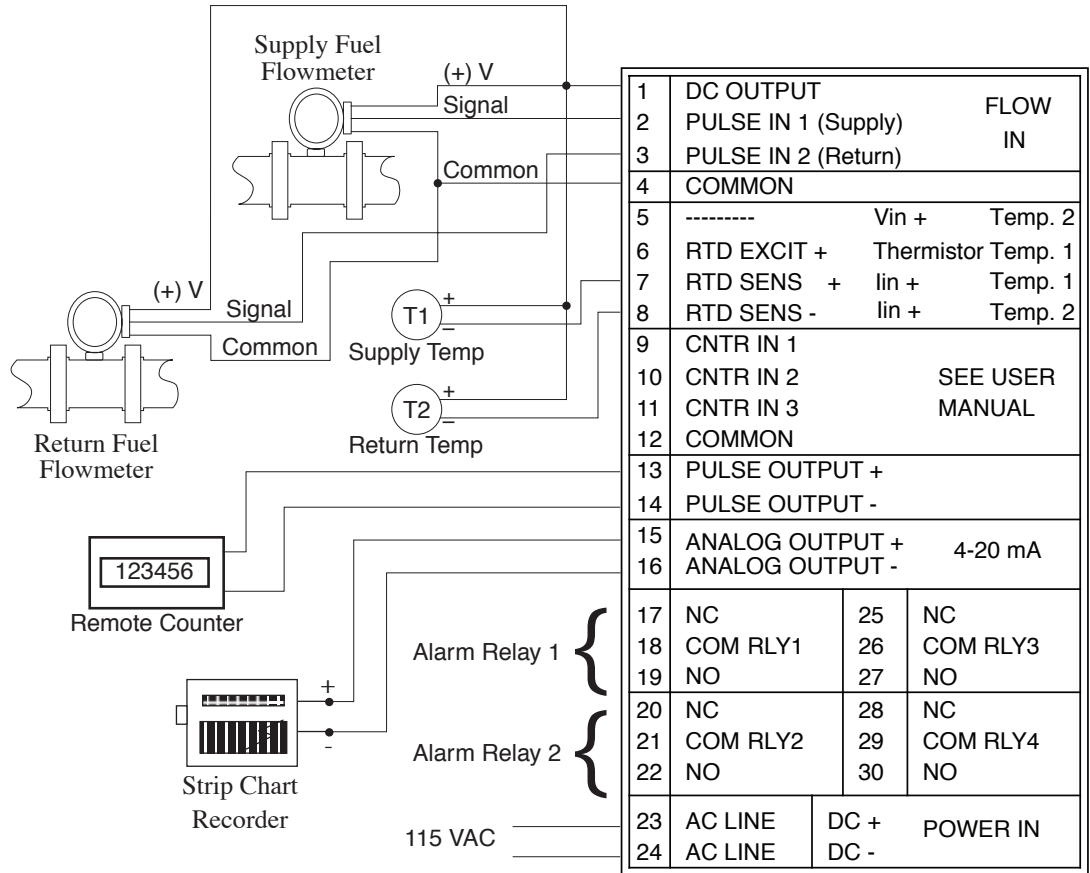

Specify available power when ordering

Relays 3 and 4 are optional

4.2 Wiring In Hazardous Areas:

Examples using MLT787S+ Barrier

**Supply
Temperature Input
(4-20mA Transmitter)**

(4-20mA Transmitter)

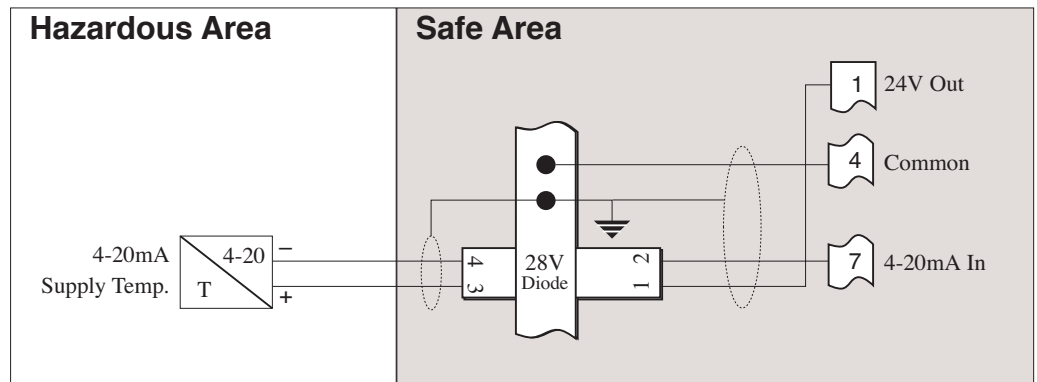

**Return
Temperature Input
(4-20mA Transmitter)**

(4-20mA Transmitter)

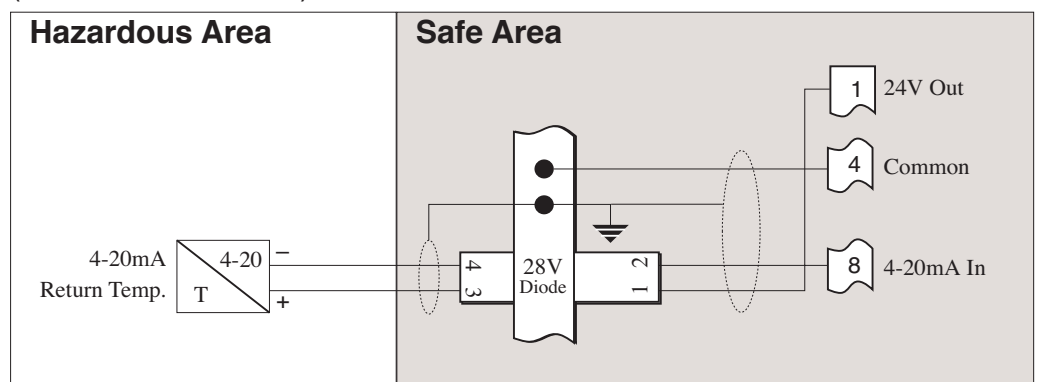

5. UNIT OPERATION

5.1 Front Panel Operation Concept for Run Mode

The 923-ST1NET-FC is fully programmable through the front panel. Please review the following usage summary before attempting to use the instrument.

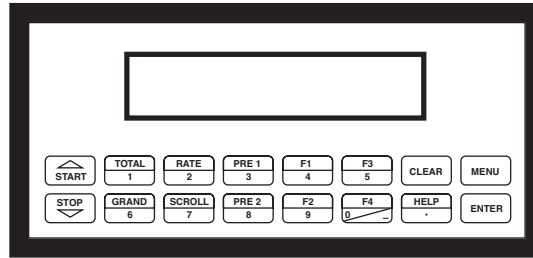

How To Use On-Line Help

HELP

On-line help is provided to assist the operator in using this product. The help is available during RUN and SETUP modes simply by pressing the HELP key. The HELP key is used to enter decimals when entering numeric values.

How To Select Fluid

SELECT FLUID

Press F1 and ENTER. Press the Δ ∇ keys to view fluid name. Press ENTER to select fluid.

How To Use Function Keys

FUNCTION KEYS

In the RUN mode, several keys have a special, direct access feature, to display an item of interest (i.e. RATE, TOTAL, etc.). Press the key to view your choice. These keys and the F1, F2 & F3 keys allow the operator to view more than one piece of information. Slowly pressing these keys additional times will display additional information. Example: Rate Key shows Net Rate, Supply Rate, Return Rate.

How To Clear The Net Total, Supply Total, Return Total

CLEARING TOTALIZERS

To clear the totals, you must press the TOTAL Function Key quickly 4 times until you see a display called "CLEAR TOTAL". Then press CLEAR to reset net, supply and return totals. You will be asked to verify this action. The operator will be prompted to enter password if the unit is locked.

How To Clear The Net Grand Total, Supply Grand Total, Return Grand Total

CLEARING GRAND TOTALS

To clear the grand totals, you must press the GRAND Function Key quickly 4 times until you see a display called "CLEAR GRAND TOTAL". Then press CLEAR to reset net, supply and return grand totals. You will be asked to verify this action. The supervisor will be prompted to enter the supervisor password if the unit is locked.

How To Enter Presets

PRESET KEYS

In the RUN mode, PRE 1 & PRE 2 keys are used to view and/or change the preset setpoints. To view the Presets, simply press the desired Preset key. Rapidly press the Preset keys 3 times, then press the Clear key for direct editing of the preset setpoints.

How To Create a Scroll List

SCROLL

Rapidly press the Scroll key three times to setup a display list. Press the CLEAR key to remove old scroll list. Press the function key F3 for the item you wish to add. Use the Δ ∇ keys to assign the line or to remove the selection.

How To Use The F3 Print Key

PRINT

The PRINT key is used to print on demand. When the F3 Print key is pressed, a user defined list of data (NET TOTAL, NET RATE, PRE 1, etc.) is sent to the RS-232 port. A timed message of "PRINTING" will be displayed to acknowledge the print request.

How To Use The Menu Key

MENU KEY

The MENU key is used to enter the Setup and Test modes. Press the MENU key to enter the Setup and Test modes. (See section 6 for Setup mode, section 8 for Test mode). The MENU key is also used as "escape" in Setup and Test Programming. Pressing the MENU key while programming in the Sub-Menu groups will backup the display to that Sub-Menu group heading. Pressing the MENU key while viewing the Sub-Menu groups will backup the display to the Top Level Menu.

How To Acknowledge Alarms

ACKNOWLEDGING ALARMS

Most alarm messages are self-clearing. Press the ENTER key to acknowledge and clear alarms.

NOTE: Some keys and functions are password protected. Enter the password to gain access. The passwords are factory set as follows:

Operator = 0 Supervisor = 2000

Alarms in the Alarm Error History will reassert themselves when power is cycled. Clear the alarm history to prevent this from happening once all problems are solved.

General Operation

5.2 General Operation

The unit can display: Net Rate, Net Total, Net Grand Total, Supply and Return Rates, Supply and Return Totals, Supply and Return Temperatures/Densities/Viscosities, Presets and Time of Day. In addition, input frequencies, computed K-factors and viscosities can be observed. The Supply and Return Temperatures and Densities can be displayed even if you are using the Volumetric Flow Equation (a Temperature sensor must be installed). The unit can perform Mass or Corrected Volume equations using a temperature sensor (these equations can be computed without Temp sensors by using user defined default values). If only one temperature is being used that value will be assigned for both the supply and return lines.

Rate/Total Operation

5.3 Ratemeter/Totalizer Operation

The Ratemeter/Totalizer mode is used primarily to monitor net flowrate and net accumulated total. The relays can be used to trigger flow, total or temperature alarms.

Password Protection (Rate/Total mode)

5.3.1 Password Protection for Rate/Total mode

After an Operator and/or Supervisor Password is entered in the setup mode (see section 6.4.23, ADMINISTRATIVE SETUP submenu), the unit will be locked. The unit will prompt the user for the password when trying to perform the following functions:

- Clear Total
- Clear Grand Total
- Enter Menu
- Edit Preset 1 (PRE 1 Key)
- Edit Preset 2 (PRE 2 Key)

The Supervisor password should be reserved for supervisors. The Supervisor password will allow access to restricted areas of the Setup and Test menus.

Relay Operation (Rate/Total mode)

5.3.2 Relay Operation in Rate/Total mode

Up to four relays are available (two standard) for alarm outputs. The relays can be assigned to trip according to net rate, net total or alarms. The relays can be programmed for low or high alarms.

Preset 1 (RLY1) and Preset 2 (RLY2) are easily accessible by pressing the PRE 1 or PRE 2 key on the front panel. Preset 3 and Preset 4 are accessible only through the setup menu. Relays 3 and 4 can be used for temperature alarms and general system alarms.

Pulse Output (Rate/Total mode)

5.3.3 Pulse Output in Rate/Total mode

The isolated pulse output (open collector) is menu assignable to Net Total or None. The total will be implied by the Flow Equation selected: Volume, Corrected Volume or Mass. The pulse output duration can be set for 10mS (50 Hz max) or 100mS (5 Hz max). A pulse output scale factor (pulse value) can be set to scale the pulse output. The pulse output is ideal for connecting to remote totalizers or other devices such as a PLC. See section 1.3 for electrical specifications.

Analog Output (Rate/Total mode)

5.3.4 Analog Output in Rate/Total mode

The analog output is menu assignable to correspond to the Net Volume Rate, Net Corrected Volume Rate or Net Mass Rate, Net Volume Total or Net Corrected Volume Total or Net Mass Total, Supply Temperature or Computed Supply Density. The analog output is ideal for "trend" tracking using strip chart recorders or other devices.

RS-232 Serial Port
(Rate/Total mode)

5.3.5 RS-232 Serial Port Operation in Rate/Total mode

The RS-232 serial port can be used for programming (using the Setup Program) or for communicating to printers and computers in the Operating Mode (Run Mode).

PC Communications:

The Setup Program also allows the user to query the unit for operating status such as Net Flow Rate, Net Flow Total, Temperature, Density, Presets, etc.

Operation of RS-232 Serial Port with Printers:

Transaction Printing

For transaction printing, the user defines the items to be included in the printed document (see section 6.3.20 SET DATA OUTPUT, Select_list). The transaction document can be initiated by pressing the F3 PRINT key or by a remote contact closure on Control Input 3.

Data Logging

In data logging, the user defines the items to be included in each data log (see section 6.3.20 SET PRINTER OUTPUT, Select_list). The user can also select when (time of day) or how often (print interval) the data log is to be made (see section 6.3.19 SET PRINTER OUTPUT, Configure). Data logs can also be initiated using the F3 print key or control input.

System Setup and Maintenance Report

The system setup and maintenance report lists all of the instrument setup parameters and usage for the current instrument configuration. The audit trail information and a status report is also printed. This report is initiated in the Test menu (see section 8.2.3 PRINT SYSTEM SETUP).

RS-485 Serial Port
(Rate/Total mode)

5.3.6 RS-485 Serial Port (optional)

RS-485 Port Description:

The optional RS-485 card utilizes Modbus RTU protocol to access a variety of process parameters and totalizers. The Relays can be controlled via Modbus. In addition, action routines (such as totalizer reset) can be executed. For further information, contact factory and request RS-485 Protocol manual.

Operation of Serial Communication Port with PC

The 923-ST1NET-FC's RS-485 channel supports a number of Modbus RTU commands. Modbus RTU drivers are available for a variety of Man Machine Interface software for IBM compatible PC's.

The user reads and writes information from/to the RS-485 using the Modbus RTU register and coil commands. The 923-ST1NET-FC then responds to these information and command requests.

Process variables and totalizers are read in register pairs in IEEE 32 bit floating point format. Time and date are read as a series of integer register values. Alarms are individually read as coils. Action routines are initiated by writing to coils.

6. PROGRAMMING

6.1 Front Panel Operation Concept for Program Mode

The 923-ST1NET-FC is fully programmable through the front panel. Please review the following usage summary before attempting to use the instrument. Refer to Appendix B as an aid in locating individual sub-menus.

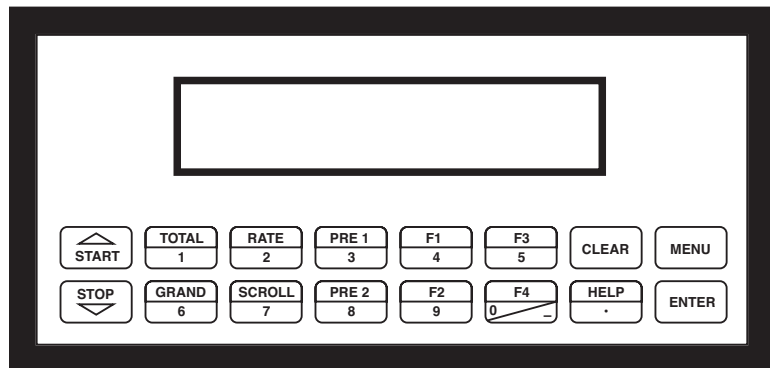

Setup Mode:

How To Make Mode Changes

MODE CHANGES

Pressing the MENU key will offer selections of RUN, SETUP, TEST. RUN is the normal operating mode for the instrument. SETUP offers various sub-menus used for instrument setup. TEST offers various sub-menus for Test, Calibration and System Start-up.

How To Navigate Through Sub-Menu Groups

Submenu GROUP NAVIGATION

Use the UP and DOWN arrow keys to navigate up and down through the Sub-Menu groups when in the SETUP or TEST mode. Press the ENTER key to enter a desired setup or test Sub-Menu group.

How To Select Program Choices

SELECTION OF ITEM

During setup, the unit will often offer multiple choices for a given topic. The topic prompt appears on the top line of the display. The choices are shown on the lower line of the display.

To select an item, press the key beneath the desired choice. The selected choice will blink. Press the ENTER key to accept the selected choice.

How To Enter Numeric Values

NUMERIC ENTRY







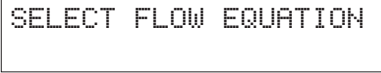

The keys labeled "0 - 9", "-", ".", CLEAR and ENTER are used to enter numerical values. A leading 0 will assume that you intend to enter a minus "-" sign. Press the CLEAR key to clear the existing value and to enable editing.

How To Enter Text Characters

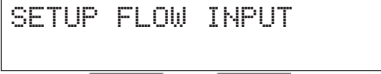
TEXT CHARACTER ENTRY

Some setup items (i.e. Descriptors, Units Label) require the user to enter text characters. Press CLEAR to enable editing. The UP and DOWN arrow keys are used to scroll through the available character sets for each individual character. Press the ENTER key to accept the character and advance to the next character until all characters needed for the label have been entered.



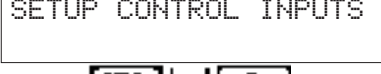
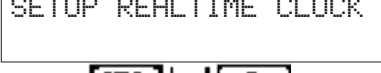
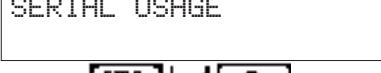
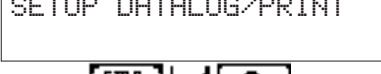
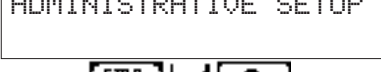
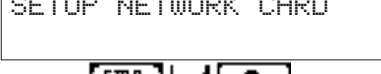





6.2 Setup Menus

Menus	Display	Notes
6.2.1 Top Level Setup Menu		Select Setup to enter the instrument setup routine.
6.2.2 Submenu Groups		Refer to Page 17 for Details.
		Refer to Pages 17-18 for Details.
		Refer to Pages 19-20 for Details.
		Refer to Page 21 for Details.
		Refer to Pages 22 for Details.
		Refer to Pages 23 for Details.
		Refer to Page 24 for Details.
		Refer to Pages 24 for Details.
		Refer to Pages 25-26 for Details.
		Refer to Page 27 for Details.
		Refer to Page 28 for Details.
		Refer to Page 29 for Details.
		Refer to Pages 30-31 for Details.
		Refer to Pages 31 for Details.
		Refer to Page 32 for Details.*

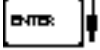
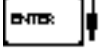
* Optional Menu only appears if option is installed

6.3 Setup Sub-Menus



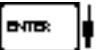





Sub-menus	Display	Notes
6.3.1 SELECT FLOW EQUATION	<pre>SELECT FLOW EQUATION</pre>	Press ENTER to enter Select Flow Equation submenus.
	<pre>ENTER</pre>	
	<pre>SELECT FLOW EQUATION Volume Mass Cor/Vol</pre>	Press ENTER when desired flow equation is flashing.
	<pre>ENTER</pre>	
	<pre>DENS EXTRACT METHOD Therm_Coef API_2540</pre>	Press ENTER when desired density extraction method is flashing.
	<pre>ENTER</pre>	
	<pre>FLOW BALANCE FACTOR 1.0000</pre>	Press ENTER when desired flow balance factor is flashing.
	<pre>ENTER</pre>	
	<pre>Advance To SETUP INDICATORS (Total)</pre>	
6.3.2 SETUP INDICATORS (Total)	<pre>SETUP INDICATORS</pre>	Press ENTER to begin setup of the Indicators
	<pre>ENTER</pre>	
	<pre>SETUP INDICATORS Total Dens Rate Temp</pre>	Press ENTER when Total is flashing to configure the Totalizer Indicators
	<pre>ENTER</pre>	
	<pre>TOTAL DESCRIPTOR TOTAL</pre>	Enter the desired Total Descriptor
	<pre>ENTER</pre>	
	<pre>VOLUME UNITS gal</pre>	Enter the desired Volume Units Label for the Totalizer.
<pre>ENTER</pre>		
	<pre>TOT DEC PLACES (0-3) 0</pre>	Select the desired Total Decimal Place. 0-3 decimal places allowed.
	<pre>ENTER</pre>	
	<pre>Advance To SETUP INDICATORS (Density)</pre>	
6.3.3 SETUP INDICATORS (Density)	<pre>SETUP INDICATORS Total Dens Rate Temp</pre>	Press ENTER when Dens is flashing to configure the Density Indicators.
	<pre>ENTER</pre>	
	<pre>DENSITY DESCRIPTOR DENS</pre>	Enter the desired Density Descriptor.
	<pre>ENTER</pre>	
	<pre>MASS UNITS lbs</pre>	Enter the desired Mass Units Label for Density.
	<pre>ENTER</pre>	
	<pre>DENS DEC PLACES(0-6) 4</pre>	Select the desired Density Decimal Place. 0-6 decimal places allowed.
<pre>ENTER</pre>		
	<pre>DENSITY DEFAULT 1 lbs/g</pre>	Enter the default density setting.
	<pre>ENTER</pre>	
	<pre>Advance To SETUP INDICATORS (Rate)</pre>	









Sub-menus	Display	Notes
6.3.4 SETUP INDICATORS (Rate)	SETUP INDICATORS Total Dens Rate Temp	Press ENTER when Rate is flashing to configure the Ratemeter Indicators
		
	RATE TIME BASE Sec Min Hour Day	Select the desired Rate Time Base.
		Enter the desired Descriptor for the Ratemeter.
	RATE DESCRIPTOR RATE	
		Select the desired Rate Decimal Place. 0-3 decimal places allowed.
	RATE DEC PLACES(0-3) 2	
	Enter desired Rate Averaging Filter for supply/return rates.	
RATE AVG FILTER 0		
	Enter desired Percent of Change for Quick Update. If the current supply/return flowrate deviates by an amount greater than the percentage value entered, the Rate Averaging is restarted with new value.	
QUICK UPDATE % 1		
	Advance To SETUP INDICATORS (Temperature)	
6.3.5 SETUP INDICATORS (Temperature)	SETUP INDICATORS total Dens Rate Temp	Press ENTER when Temp is flashing to configure the Temperature Indicators.
		
	TEMP DESCRIPTOR TEMP	Enter the desired Temperature Descriptor.
		
	TEMPERATURE SCALE Deg_C Deg_F	Enter the desired Temperature Scale.
		Select the desired Temperature Decimal Place. 0-3 decimal places allowed.
	TEMP DEC PLACES(0-3) 1	
		
TEMPERATURE DEFAULT 60 F	Enter the default temperature	
	Advance To SETUP FLOW INPUT	









Submenus	Display	Notes		
6.3.6 SETUP FLOW INPUT	<pre> SETUP FLOW INPUT </pre>	Press ENTER to begin setup of Flow Input.		
	<pre> ENTER </pre>	<pre> EXCITATION VOLTAGE 5V 12V 24V </pre>	Select the desired Excitation Voltage. NOTE: DC models do not support the 24V selection.	
	<pre> ENTER </pre>	<pre> PULSE TRIGGER LEVEL 10mV 100mV 2.5V </pre>	Select the desired Input Pulse Trigger Level.	
	<pre> ENTER </pre>	<pre> LOW PASS FILTER 40Hz 3KHz 20KHz </pre>	Select the desired Low Pass Filter. (Max. Count Speed).	
	<pre> ENTER </pre>	<pre> INPUT TERMINATION Pullup Pulldown None </pre>	Select the proper input termination.	
	<pre> ENTER </pre>	<pre> MAX WINDOW (1-99) 1 sec </pre>	Enter the desired Maximum Sample Window Time (1-99 sec).	
	<pre> ENTER </pre>	<pre> K_FACTOR TYPE AvgK LinTbl UVC StRo </pre>	Enter the desired K-Factor Type. See side note.	
	<pre> ENTER </pre>	<pre> AVERAGE KA-FACTOR ##### P/gal </pre>	If Avg selected, Enter the desired Average K-Factor (KA for Supply).	
	<pre> AVERAGE KB-FACTOR ##### P/gal </pre>	Enter the desired Average K-Factor (KB for Return).		
	<pre> CHANGE TABLE A No Yes </pre>	If LinTbl selected, Select YES to change that table		
	Through 40 Points	<pre> LINEAR TABLE KA Fre01:##### Hz </pre>	Enter the desired frequency/ K-Factor pair (in ascending order of Hz) for each point in the Linearization Table. (Table A = Supply)	
		<pre> ENTER </pre>	<pre> LINEAR TABLE KA KA--01:##### P/gal </pre>	NOTE: Enter 0 for Fre value of any point (other than Fre01) to exit the routine and use only the values entered up to that point.
	Through 40 Points	<pre> ENTER </pre>	<pre> CHANGE TABLE A No Yes </pre>	Enter the desired frequency/ K-Factor pair (in ascending order of Hz) for each point in the Linearization Table. (Table B = Return)
		<pre> ENTER </pre>	<pre> LINEAR TABLE KA Fre01:##### Hz </pre>	NOTE: Enter 0 for Fre value of any point (other than Fre01) to exit the routine and use only the values entered up to that point.
	Through 40 Points	<pre> ENTER </pre>	<pre> CHANGE TABLE A No Yes </pre>	If UVC selected, Select YES to change that table
<pre> ENTER </pre>		<pre> LINEAR TABLE KA Fre01:##### Hz/ck </pre>	Enter the desired Hz/ck/ K-Factor pair (in ascending order of Hz/ck) for each point in the Linearization Table. (Table A = Supply)	
Through 40 Points	<pre> ENTER </pre>	<pre> LINEAR TABLE KA KA--01:##### P/gal </pre>	NOTE: Enter 0 for Hz/ckvalue of any point (other than Hz/ck01) to exit the routine and use the values entered up to that point.	
	<pre> ENTER </pre>	<pre> LINEAR TABLE KA Fre01:##### Hz/ck </pre>	Enter the desired Hz/ck/ K-Factor pair (in ascending order of Hz/ck) for each point in the Linearization Table. (Table B = Return)	
Through 40 Points	<pre> ENTER </pre>	<pre> LINEAR TABLE KB Fre01:##### Hz/ck </pre>	NOTE: Enter 0 for Hz/ck value of any point (other than Hz/ck01) to exit the routine and use the values entered up to that point.	
	<pre> ENTER </pre>	<pre> LINEAR TABLE KB KB--01:##### P/gal </pre>		

Continued On Next Page

Sub-menus	Display	Notes
6.3.6 SETUP FLOW INPUT (continued)	Through 40 Points LINEAR TABLE KB RoB01:##### [ENTR] ↓	If StRo selected, Enter the desired St/ Ro pair (in ascending order of St/Ro) for each point in the Linearization Table. (Table A Is Supply; Table B is Return)
	LINEAR TABLE KB StB01:##### [ENTR] ↓	
	Through 40 Points LINEAR TABLE KB RoB01:##### [ENTR] ↓	NOTE: Enter 0 for Ro value of any point (other than RoA01) to exit the routine and use the values entered up to that point.
	LINEAR TABLE KB StB01:##### [ENTR] ↓	
	LOW FLOW RATE ALARM ##### gal/s [ENTR] ↓	Enter the desired volumetric Low Rate Alarm. This will trigger a visual message if alarm conditions occur. The relays are not affected.
	HIGH FLOW RATE ALARM ##### gal/s [ENTR] ↓	Enter the desired volumetric High Rate Alarm. This will trigger an alarm message if alarm conditions occur. The relays are not affected.
	METER EXPAN [xe - 6] 0 ppm/f [ENTR] ↓	If UVC or StRo selected, Enter the expansion coefficient for the meter housing.
	CALIBRATION TEMPERATURE 70 F [ENTR] ↓	If UVC or StRo selected, Enter the calibration temperature.
	H2O DENSITY AT 4 DEG C 8.34519 lbs/g [ENTR] ↓	If UVC or StRo selected, Enter the density of water at 4° C.
	Advance To SETUP AUX1 INPUT	

Sub-menus	Display	Notes
6.3.7 SETUP AUX1 INPUT	<pre> SETUP AUX1 INPUT </pre>	Press ENTER to begin setup of the Auxiliary 1 Input corresponding to supply temperature.
		
	<pre> AUX1 INPUT TYPE None Temp </pre>	Select "Temp" to indicate a temperature transmitter will be used on the supply line.
		
	<pre> AUX1 SIGNAL TYPE Therm. Current RTD </pre>	If "Temp" selected, Choose Signal Type: Thermistor, Current Range or RTD. (Skip if "None" selected)
		
	<pre> CURRENT RANGE 4-20mA 0-20mA </pre>	If "Current" selected, Choose applicable Current Range for the transmitter. (Skip if "None" selected)
		
	<pre> AUX1 LOW SCALE ##### F </pre>	Enter the low temperature scale corresponding to the low temperature signal.
		
	<pre> AUX1 FULL SCALE ##### F </pre>	Enter the high temperature scale corresponding to the high temperature signal.
		
	<pre> AUX1 Offset Temp ##### F </pre>	Enter the Low Offset Temperature. to correct for any small errors observed in the measurement on supply temperature.
		
	<pre> AUX1 LOW ALARM ##### F </pre>	Enter the Low setpoint for the Temperature Alarm warning to the operator.
		
	<pre> AUX1 HIGH ALARM ##### F </pre>	Enter the High setpoint for the Temperature Alarm warning to the operator.
		
	<p style="text-align: center;">Advance To SETUP AUX2 INPUT</p>	

Sub-menus	Display	Notes
6.3.8 SETUP AUX 2 INPUT	<pre> SETUP AUX2 INPUT </pre> 	Press ENTER to begin setup of the Auxiliary 2 Input corresponding to return temperature.
NOTE: If "None" selected: TEMP2 = TEMP1	<pre> AUX2 INPUT TYPE None Temp AUX1 </pre> 	Select "Temp" to indicate a temperature transmitter will be used on the return line or else use AUX1 for return Temperature as well.
	<pre> AUX2 SIGNAL TYPE Voltage Current </pre> 	If "Temp" selected, Choose Voltage or Current for the transmitter input type. (Skip if "None" selected)
	<pre> VOLTAGE RANGE 0-10V 0-5V 1-5V </pre> 	If "Voltage" selected, Choose applicable Voltage Range for the transmitter.
	<pre> CURRENT RANGE 4-20mA 0-20mA </pre> 	If "Current" selected, Choose applicable Current Range for the transmitter.
	<pre> AUX2 LOW SCALE ##### F </pre> 	Enter the low temperature scale corresponding to the low temperature signal.
	<pre> AUX2 FULL SCALE ##### F </pre> 	Enter the high temperature scale corresponding to the high temperature signal.
	<pre> AUX2 LOW ALARM ##### F </pre> 	Enter the Low setpoint for the Temperature Alarm warning to the operator.
	<pre> AUX2 HIGH ALARM ##### F </pre> 	Enter the High setpoint for the Temperature Alarm warning to the operator.
	<p>Advance To SET FLUID PROPERTIES</p>	

Sub-menus	Display	Notes	
<p>6.3.9 SET FLUID PROPERTIES</p>	<p>SET FLUID PROPERTIES</p>	<p>Press ENTER at this prompt to Set Fluid Properties.</p>	
		<p>FLUID NUMBER (0-9) 0</p>	<p>Up to 10 Fluid types may be stored in the unit. Select the number of the desired fluid to edit.</p>
		<p>FLUID NAME Generic #0</p>	<p>Shows name and number of fluid selected. Enter the desired name using the up/down arrow keys.</p>
		<p>REF. DENSITY ##### lbs/g</p>	<p>Enter the Reference Density. This is used in the calculation of density when you have a temp transmitter and used for corrected flow calculation if you have a density transmitter.</p>
		<p>REF. TEMPERATURE ##### F</p>	<p>Enter the Reference Temperature.</p>
		<p>EXPAN. FACTOR [xe-6] #####</p>	<p>Enter the proper Fluid Expansion Factor. (If Temp Compensated for Mass or Corrected Volume) See Section 7.3, Calculating the Fluid Expansion Factor.</p>
		<p>VISCOSITY COEF. A 0.000</p>	<p>Enter the Viscosity A Coefficient. See section 7.4, Computation of Viscosity Coef. A and B.</p>
		<p>VISCOSITY COEF. B 0.000</p>	<p>Enter the Viscosity B Coefficient. See section 7.4, Computation of Viscosity Coef. A and B.</p>
		<p>Advance To SETUP PULSE OUTPUT</p>	<p>NOTE: The propertire for several common fluids are listed in Appendix A. These are also included in the setup software.</p>



Sub-menus	Display	Notes
<p>6.3.10 SETUP PULSE OUTPUT</p>	<pre> SETUP PULSE OUTPUT </pre>	<p>Press ENTER at this prompt to setup the Pulse Output.</p>
	<pre> ENTER: v PULSE OUTPUT USAGE Off Total </pre>	<p>Select the desired Pulse Output Usage. "Total" corresponds to Net Total.</p>
	<pre> ENTER: v PULSE WIDTH 10mS 100mS </pre>	<p>Select the desired Pulse Width for the Pulse Output.</p>
	<pre> ENTER: v PULSE VALUE ##### gal/P </pre>	<p>Enter the desired Pulse Value for the Pulse Output (Units per Pulse).</p>
	<pre> ENTER: v Advance To SETUP ANALOG OUTPUT </pre>	
<p>6.3.11 SETUP ANALOG OUTPUT</p>	<pre> SETUP ANALOG OUTPUT </pre>	<p>Press ENTER when Analog is flashing to setup the Analog Output.</p>
	<pre> ENTER: v ANALOG OUTPUT USAGE Rate Tot Temp Dens </pre>	<p>Select the desired Analog Output Usage. "Rate" corresponds to Net Rate</p>
	<pre> ENTER: v ANALOG OUTPUT RANGE 4-20mA 0-20mA </pre>	<p>Select the desired current range for the Analog Output.</p>
	<pre> ENTER: v LS ANALOG OUTPUT ##### gal/m </pre>	<p>Enter desired Analog Output Low Scale Value. NOTE: Units label will correspond with output usage type selected.</p>
	<pre> ENTER: v FS ANALOG OUT 20mA ##### gal/m </pre>	<p>Enter desired Analog Output Full Scale Value.</p>
	<pre> ENTER: v ANALOG OUT DAMPING 0.0 </pre>	<p>Enter the desired Analog Output Damping Constant. Increase value to slow response time and eliminate "bounce".</p>
<pre> ENTER: v Advance To SETUP RELAYS </pre>		







Sub-menus	Display	Notes
<p>6.3.12 SETUP RELAYS (Relay 1 & Relay 2)</p>	<pre> SETUP RELAYS R1y1 R1y2 R1y3 R1y4 [ENTER] RELAY 1 USAGE RATE TOTAL NA [ENTER] RELAY 1 DELAY sec 0 [ENTER] RELAY 1 MODE LO_ALARM HI_ALARM [ENTER] RELAY 1 DURATION ##### [ENTER] RELAY 1 SETPOINT ##### gal [ENTER] RELAY 1 HYSTERESIS ##### gal/m [ENTER] Advance To SETUP RELAYS 3, 4 </pre>	<p>Select the desired Relay for setup. (Relays 3 & 4 Optional)</p> <p>If Relay 1 or Relay 2 Selected, Select Net Rate, Net Total or Not Assigned.</p> <p>If Rate selected, enter desired relay activation delay value.</p> <p>Select the desired Relay Activation. Low: Relay activates when Net reading is below setpoint. High: Relay activates when Net reading is above setpoint.</p> <p>If Net Total Selected, Enter desired Relay Duration for Alarm. "0" will latch Alarm indefinitely.</p> <p>Enter the desired Setpoint. The Setpoint can be edited in run mode using the PRE 1 key (PRE 2 key for Relay 2).</p> <p>If Net Rate, selected, Enter desired Relay Hysteresis.</p>

Sub-menus	Display	Notes
6.3.12 (Continued) SETUP RELAYS (Relay 3 & Relay 4)	<pre> SETUP RELAYS R1y1 R1y2 R1y3 R1y4 ENTER </pre>	Select the desired Relay for setup. (Relays 3 & 4 Optional)
NOTE: Settings for Relays 3 & 4 may be entered even if relays are not supplied. The settings will still trigger display alarms.	<pre> RELAY 3 USAGE Rate Total Aux NA </pre>	If Relay 3 Selected, Choose Rate, Total, Aux or NA.
	<pre> RELAY 4 USAGE Rate Tot Aux Alrm NA ENTER </pre>	If Relay 4 Selected, Choose Rate, Total, Aux, Alrm or NA.
	<pre> ASSIGN AUX CHANNEL AUX 1 AUX 2 ENTER </pre>	If Aux selected, enter desired auxilliary channel.
	<pre> RELAY 3 DELAY sec 0 ENTER </pre>	If Rate / Aux selected, enter desired relay activation delay value.
	<pre> RELAY 3 MODE LO_ALARM HI_ALARM ENTER </pre>	Select the desired Relay Activation for Rate/Aux. Low: Relay activates when Net reading is below setpoint. High: Relay activates when Net reading is above setpoint.
	<pre> RELAY 3 DURATION ##### ENTER </pre>	If Net Total Selected, Enter desired Relay Duration.
	<pre> RELAY 3 SETPOINT ##### gal ENTER </pre>	Enter the desired Setpoint.
	<pre> RELAY 3 HYSTERESIS ##### gal/m ENTER </pre>	If Net Rate, selected, Enter desired Relay Hysteresis.
Advance To SETUP CONTROL INPUTS		

RELAY NOTES & CONSIDERATIONS













1. Relay activation is based on the computed readings not the displayed value. Therefore the display damping factor will not affect the relay response time. The RELAY DELAY feature allows the user to enter a time delay for relay activation. This feature is very useful in applications where short over/under range conditions are not considered alarm conditions.
2. Setting the relays to NA (Not Assigned), will allow the relay activation to be controlled via the RS-232 Serial and/or RS-485 Modbus ports.
3. Relay 3 and Relay 4 settings may be used to trigger display alarm conditions to the operator even if the relays are not supplied.

Sub-menus	Display	Notes
<p>6.3.13 SETUP CONTROL INPUTS</p>	<pre> SETUP CONTROL INPUTS </pre>	<p>Press Enter to begin setup of the Control Inputs.</p>
		<p>Select the desired Control Input for setup.</p>
	<pre> SETUP CONTROL INPUTS Input1 Input2 Input3 </pre>	
		
	<pre> CONTROL INPUT1 USAGE INHIBIT_TOTAL NA </pre>	<p>If Control Input 1 Selected, Select Inhibit Total or NA (Not Assigned).</p>
<pre> CONTROL INPUT2 USAGE RESET_TOTAL NA </pre>	<p>If Control Input 2 Selected, Select Reset Total or NA (Not Assigned).</p>	
<pre> CONTROL INPUT3 USAGE Prn Ack KeyLk NA </pre>	<p>If Control Input 3 Selected, Select Prn (Print), Ack (acknowledge alarm), KeyLk (Keylock) or NA (Not Assigned). ACK will acknowledge and clear alarms and warning messages. The Alarm History is <u>NOT</u> cleared.</p>	
	<p>Advance To SETUP REALTIME CLOCK</p>	
		<p>Note: Alarms may reassert themselves if alarm conditions are still present.</p>

Sub-menus	Display	Notes
6.3.14 SETUP REALTIME CLOCK (Time)	SETUP REALTIME CLOCK	Press Enter to begin setup of the Realtime Clock.
	 SETUP REALTIME CLOCK Time Date	Select Time to set the time.
	 CLOCK TYPE 24HR 12HR	Select 24Hr or 12Hr clock
	 SELECT CLOCK AM/PM AM PM	If 12Hr Clock, Enter AM or PM
	 TIME OF DAY HH:MM:SS ##:##:##	Enter time of day.
Advance To SETUP REALTIME CLOCK (Date)		
6.3.15 SETUP REALTIME CLOCK (Date)	SETUP REALTIME CLOCK Time Date	Select Date to enter the date.
	 DATE: MONTH, DAY, YEAR ##/##/####	Enter the date. (Month, Day, Last two digits of Year)
 Advance To SERIAL USAGE		

Sub-menus	Display	Notes
6.3.16 SERIAL USAGE (RS-232/485)	<pre>SERIAL USAGE</pre>	Press Enter to begin setup of the Serial Port.
	<pre> ENTER SERIAL HARDWARE RS232 RS485 </pre>	Select Serial Hardware type for standard port. Select RS485 only on special order. (See SETUP NETWORK CARD for RS485 Modbus option)
	<pre> ENTER DEVICE ID ## </pre>	Select the Device ID.
	<pre> ENTER BAUD RATE 300 600 1200 <more> </pre>	Select the desired Baud Rate.
	<pre> BAUD RATE 2400 4800 9600 19200 </pre>	(If <more> selected)
	<pre> ENTER PARITY None Odd Even </pre>	Select the desired Parity.
	<pre> ENTER HANDSHAKING None Software Hardwre </pre>	Set the Handshake.
	<pre> ENTER DEVICE LINE FEED <CR> <CR+LF> </pre>	Choose end of line termination. Only choose <CR> if your external device automatically assigns a line feed for every <CR> carriage return.
6.3.17 SERIAL USAGE (Modem Options)	<pre> MODEM OPTIONS No Yes </pre>	Select "Yes" if the serial port will be used to control a modem.
	<pre> ENTER MODEM INIT MASTER No Yes </pre>	Select "Yes" to have the unit engage in a configuration conversation with the modem on power up .
	<pre> ENTER MODEM AUTO ANSWER No Yes </pre>	If "YES" selected for Modem Init Master, choose the desired Modem Auto Answer mode.
	<pre> ENTER CALL OUT DAY OF WEEK 1 </pre>	Enter the day of the week to perform Call Out transmission. (0 = daily, 1 - 7 = Mon - Sun)
	<pre> ENTER CALL OUT TIME ##:##:## </pre>	Enter the time of day to perform Call Out transmission. (HH:MM:SS)
	Continued on Next Page	

Sub-menus	Display	Notes
6.3.17 SERIAL USAGE (Modem Options) (continued)	<pre>CALL ON ERROR/ALARM No Yes ENTER: ↓</pre>	Select "Yes" to have the unit perform a Call Out transmission upon error/alarm condition.
	<pre>CALL OUT PHONE # 0 ENTER: ↓</pre>	Call Out Phone Number to be dialed for "Call Out Time" or "Print On Error/Alarm". (Up to 20 digits with "." used to pause between digits)
	<pre>NUMBER OF REDIALS 0 ENTER: ↓</pre>	Enter the number of redials to be performed on call out time if busy or no answer (error/ alarm tries until connected).
	<pre>HANGUP IF 2MIN INACT No Yes ENTER: ↓</pre>	Select "Yes" to perform hangup if there is inactivity for more than 2 minutes.
	Advance To SETUP DATALOG/PRINT	
6.3.18 SETUP DATALOG/PRINT (Configure)	<pre>SETUP DATALOG/PRINT ENTER: ↓</pre>	Press Enter to setup the Datalog/Print information.
	<pre>SETUP DATALOG/PRINT Config Select_list ENTER: ↓</pre>	Select Config to configure the Datalog/Print information.
	<pre>OUTPUT FORMAT Printer Term Dbase ENTER: ↓</pre>	Select the type of Output Format.
	<pre>PAGE LENGTH [99 max] 99 ENTER: ↓</pre>	Enter the desired Page Length. If Printer selected above.
	<pre>TOP MARGIN [99 max] 3 ENTER: ↓</pre>	Enter the desired Top Margin. If Printer selected above.
	<pre>DATALOG ONLY No Yes ENTER: ↓</pre>	Select Yes to record events to the datalogger only. Events will not be sent to the serial port.
	<pre>PRINT TIME HH:MM:SS 00:00:00 ENTER: ↓</pre>	Enter Print Time, printer will print at this time every day. Enter 00:00:00 to inhibit print time.
	<pre>PRINT INTERVAL 00:00:00 ENTER: ↓</pre>	Enter Print Interval, Enter 00:00:00 to inhibit print interval..
	<pre>ENABLE PRINT KEY NO YES ENTER: ↓</pre>	Select YES to enable Print Key. Select NO to disable Print Key
	<pre>CLEAR TOTAL IF PRINT NO YES ENTER: ↓</pre>	Select Yes to clear the total after printing. This feature is useful for recording totals, then clearing totals automatically after log or printout has been completed.
Advance To SETUP DATALOG/PRINT (Select_list)		

Sub-menus	Display	Notes
6.3.19 SETUP DATALOG/PRINT (Select_list)	<pre>SET DATALOG/PRINT</pre>	Press enter to begin Setup Datalog/Print routine.
		
	<pre>SET DATALOG/PRINT Conf# Select_list</pre>	Press enter when Select_list is selected to setup print list.
List Items:	<pre>PRINT LIST ITEMS TIME YES</pre>	Use Up and Down arrow keys to view list status.
TIME N_RATE S_RATE R_RATE N_TOTAL S_TOTAL R_TOTAL N_GRAND S_GRAND R_GRAND S_TEMP R_TEMP S_DENS R_DENS S_VISC R_VISC FLUID PRE1 PRE2 FREQ1 FREQ2 KA-F KB-F	<pre>PRINT LIST ITEMS N_RATE YES</pre>	Press the Print or function key for the items that you wish to add or remove from the list. Items marked with Yes will be added to the list, items marked with No will be removed from the list.
	<pre>PRINT LIST ITEMS N_TOTAL YES</pre>	N_ corresponds to NET S_ corresponds to SUPPLY R_ corresponds to RETURN
		
	<pre>PRINT LIST ITEMS DataLog size =00455</pre>	The Select Print List Information display shows the current possible Datalog size.
		
	Advance To ADMINISTRATIVE SETUP	
6.3.20 ADMINISTRATIVE SETUP	<pre>ADMINISTRATIVE SETUP</pre>	Press Enter to begin Administrative Setup.
		
	<pre>TAG NUMBER FT XXXX</pre>	Use the up and down arrow keys to define the tag number.
		
	<pre>OPERATOR PASSWORD *****</pre>	Enter Operator Password. (Factory Set to 0)
		
	<pre>SUPERVISOR PASSWORD *****</pre>	Enter Supervisor Password, if logged in as supervisor. (Factory Set to 2000)
		
	<pre>SOFTWARE VERSION VXX.XXX</pre>	This display is used to show the software version of the installed software.
		
	<pre>PRODUCT ORDER CODE ST1NETFCxxxxxxxx</pre>	This display is used to show the product order code (model number).
		
	<pre>UNIT SERIAL NUMBER 00000</pre>	This display is used to show the unit's serial number.
		
	<pre>SENSOR SERIAL NUMBER 00000</pre>	This display is used to show the sensor's serial number.
		
	<pre>DISPLAY NEW ERR ONLY No Yes</pre>	If yes is selected, an error message will only appear once until acknowledged by user.
		
	Advance To INSTRUMENT TYPE	Advance to Network Card only if a Network Card is installed.

**6.3.21
SETUP
NETWORK CARD
(optional)**

```
SETUP NETWORK CARD
```

Press Enter to setup Network Card

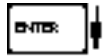

```
SELECT NTW PROTOCOL  
ModbusRTU
```

Select desired Network Protocol.

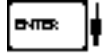

```
NETWORK DEVICE ID  
1
```

Enter the device address on network (00-255).

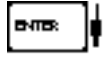

```
BAUD RATE  
2400 4800 9600 19200
```

Select the desired Baud Rate.



```
PARITY  
None      Odd      Even
```

Select the desired Parity.



```
Advance To  
INSTRUMENT TYPE
```

7. Principle Of Operation

General Operation

7.1 General:

The 923-ST1NET-FC Flow Computer uses several internal calculations to compute the net compensated flow based on specific data input. Several computations are performed to arrive at the uncompensated flow, supply and return temperatures, density and viscosity. This information is then used to compute the Corrected Volume Flow or Mass Flow.

Note concerning Fluid Information

The user will be prompted for Fluid Information during the setup of the instrument. The unit can store the fluid properties for up to 10 different fluids at one time. See also Appendix A for common fluid properties for liquids.

Flow Equations

7.2 Flow Equations:

Input Temperature Computation:

General Case

$$Tf1 = [\% \text{ input span} \cdot (\text{temp FS} - \text{Temp low scale})] + \text{temp low scale}$$

$$Tf2 = [\% \text{ input span} \cdot (\text{temp FS} - \text{Temp low scale})] + \text{temp low scale}$$

Fluid Properties:

Liquid Generic Case

$$\text{liquid density1} = \text{reference density} \cdot (1 - (\text{Therm. Exp. Coef.} \times 10^{-6} (Tf - Tref))^2)$$

$$\text{liquid density2} = \text{reference density} \cdot (1 - (\text{Therm. Exp. Coef.} \times 10^{-6} (Tf - Tref))^2)$$

Liquid API Case

$$\text{liquid density1} = \text{reference density} \cdot (\text{VCF API2540})$$

$$\text{liquid density2} = \text{reference density} \cdot (\text{VCF API2540})$$

Where:

Tf1 = Supply Temperature via AUX 1

Tf2 = Return Temperature via AUX 2

NOTE: If AUX2 Usage = AUX1; TF2 = TF1

Liquid Density1 = Computed density at Supply Temperature from AUX1

Liquid Density2 = Computed density at Return Temperature from AUX2

NOTE: If AUX2 Usage = AUX1; Liquid Density2 = Liquid Density1

NOTE: If both AUX1 and AUX2 Usage = NONE: TF2 = TF1 = Default Temperature

7.2 Flow Equations: (Continued)

Fluid Equations Viscosity Computation:

Liquid Case

$$\dagger \text{ centistokes1} = \left(A \exp \frac{B}{(\text{Deg F} + 459.67)} \right)$$

$$\dagger \text{ centistokes2} = \left(A \exp \frac{B}{(\text{Deg F} + 459.67)} \right)$$

Where: centistokes = cP/(kg/l)

centistokes1 = computed viscosity in supply

centistokes2 = computed viscosity in return

Uncompensated Flow Computation:

Pulse Input; Average K-Factor

$$\text{Volume Flow}_{1, 2} = \frac{\text{input frequency} \cdot \text{time scale factor}}{\text{K-Factor}}$$

Pulse Input; Linear Table

$$\text{Volume Flow}_{1, 2} = \frac{\text{input frequency} \cdot \text{time scale factor}}{\text{K-Factor (Hz)}}$$

Pulse Input; UVC Table

$$\text{Volume Flow}_{1, 2} = \frac{\text{input frequency} \cdot \text{time scale factor}}{\text{K-Factor (Hz/cstk)}}$$

Pulse Input; Strouhal/Roshko Table

$$\text{Volume Flow}_{1, 2} = \frac{\text{input frequency} \cdot \text{time scale factor}}{\text{Strouhal Cal} / (1 + 3 \cdot \text{meter exp coeff.} \cdot 10^{-6} (\text{Tf-Tcal}))}$$

$$\text{Roshko Cal}_{1, 2} = \frac{\text{input frequency} \cdot (1 + 2 \cdot \text{meter exp coeff.} \cdot 10^{-6} (\text{Tf-Tcal}))}{\text{cstk}}$$

Corrected Volume Flow Computation:

Liquid Case

Generic Case

$$\text{Standard Volume Flow} = \text{volume flow} \cdot (1 - \text{Therm.Exp.Coeff.} \cdot (\text{Tf-Tref}))^2$$

API Case

$$\text{Standard Volume Flow} = \text{volume flow} \cdot (\text{UCF API2540})$$

Mass Flow Computation:

$$\text{Mass Flow} = \text{volume flow} \cdot \text{density}$$

Net Flow Computation:

$$\text{Net Flow} = \text{Flow A} - (\text{Fluid Balance} \cdot \text{Flow B})$$

7.2 Flow Equations: (Continued)

Flow Equations

API 2540 Equation. The American Petroleum Institute, in a joint program with the National Bureau of Standards (NIST), developed a density equation based on 463 samples of five different oil products. The results of this work are incorporated into Chap. 11.1, "Volume Correction Factors," of API Standard 2540 (1987).

The density equation is based on the thermal-expansion coefficient of the product at 60°F (15.6°C) base temperature, which is calculated from the base density as

$$\alpha_b = \frac{K_0}{\rho_b^{*2}} + \frac{K_1}{\rho_b^*} \quad (2.188)$$

where the base density ρ_b^* is in kilograms per cubic meter. The empirically derived constants K_0 and K_1 for the five product groups are given in Table 2.23. The density of the product at flowing temperature is then calculated as

$$\rho_F^* = \rho_b^* \exp [-\alpha_b \Delta T_F (1 + 0.8\alpha_b \Delta T_F)] \quad (2.189)$$

where $\Delta T_F = T_F - 60$. The specific gravity at flowing or measured temperature is then

TABLE 2.23 Constants K_0 and K_1 for Five Product Groups

Product group	K_0	K_1
Crude oils and JP4†	341.0957	0.0
Jet fuels, kerosenes, solvents	330.3010	0.0
Gasolines and naphthenes	192.4571	0.2438
Lubricating oils	144.0427	0.1895
Diesel oil, heating oils, fuel oils	103.8720	0.2701

Note: Pentanes and hydrocarbons lower in the hydrocarbon chain are *not* covered by this data.

†API News Release 1987 added JP4.

The above information was obtained from "Flow Measurement Engineering Handbook, 3rd Edition" by Richard W Miller.

API 2540 Expansion Factor Equation

1. Select the values for K_0 and K_1 for the fluid group to be measured
2. Convert the base reference density for your fluid into the corresponding density units of kg/m^3
3. Solve for α_b using equation above
4. $C = \alpha_b \cdot 1,000,000$

7.3 Calculating the Fluid Expansion Factor for Generic Case

Calculating Expansion Factor

The liquid density is a function of the flowing temperature for many fluids. This unit solves an equation which represents this physical property of the fluid.

The information which the unit uses to describe the fluid is entered by the user in the following variables: Reference Temperature, Reference Density, Fluid Expansion Factor. Values for common fluids are listed in Appendix A for the generic case.

This information is available for many fluids in one or more of the following forms:

Fluid Specific Gravity vs. Temp. Table

Specific Gravity vs. Temp. Graph

Fluid Density vs. Temp. Table

Fluid Density vs. Temp. Graph

Begin by obtaining one of the fluid properties for the fluid you are using from available manufacturers information or Engineering Handbooks. In some cases this information is listed on the Material Safety Data Sheet for the fluid.

Two temperature-specific gravity pairs will be required to compute the temperature coefficient.

The reference temperature is simply chosen by the user. Common reference temperatures are 60° F or 15° C.

The reference temperature should be chosen so that it is in the application temperature range. i.e. application temperature range -10 to 120° F, reference temperature of 60° F chosen.

Enter the reference temperature you have chosen at this point.

The reference specific gravity corresponds to the fluid SPECIFIC GRAVITY at the reference temperature chosen.

You may convert the fluid density information to specific gravity if it is in units other than specific gravity. Use EQ1.

Expansion Factor Equations

EQ1.

$$\text{Spec.Grav.} = \text{Density of Fluid} / \text{Density of Water}$$

Given the reference temperature, reference specific gravity, a second temp. and a second Spec.Grav., the Expansion Factor (C Factor) can be computed as follows:

EQ2. Used for Liquid Mass and Corrected Volume Equations

$$C = \left[\frac{1 - \sqrt{(\text{Spec.Grav.2} / \text{Ref.Spec.Grav.})}}{\text{Temp.2} - \text{Ref.Temp}} \right] \times 1,000,000$$

Given the reference temperature, reference density, a second temp. and a second density, the Expansion Factor (C Factor) can be computed as follows:

EQ3. Used for Liquid Mass and Corrected Volume Equations

$$C = \left[\frac{1 - \sqrt{(\text{Dens.2} / \text{Ref.Dens.})}}{\text{Temp.2} - \text{Ref.Temp}} \right] \times 1,000,000$$

C = Fluid Expansion Factor

7.4 Computation of Viscosity Coef. A and B

Computation of Viscosity Coef. A & B

The flow computer solves a generic equation which computes the viscosity in cstk as a function of temperature. Two parameters must be entered for this calculation to be performed. These are the setup parameters Viscosity Coef. A and Viscosity Coef. B. A table listing these values for common fluids is available in Appendix A.

Alternately, if your intended fluid is not listed, the Viscosity Coef. A and B can be derived from two known temperature/viscosity pairs. Begin by obtaining this information for your intended fluid. Convert these known points to units of Degrees F and centistoke (cstk)

The information is now in a suitable form to compute the Viscosity Coef. A and Viscosity Coef. B using the following equation based on the fluid state.

For a liquid, A and B are computed as follows:

$$B = \frac{(T1 + 459.67) \cdot (T2 + 459.67) \cdot \ln [\text{cstk1}/\text{cstk2}]}{(T2 + 459.67) - (T1 + 459.67)}$$

$$A = \frac{\text{cstk1}}{\exp [B / (T1 + 459.67)]}$$

NOTE: cS = $\frac{\text{cP} \cdot \text{Density of Water at } 4^{\circ}\text{C}}{\text{Density of Fluid at Flowing Conditions}}$

7.5 Linearization Table

Linearization Table General Information

7.5.1 Linearization Table General Information

The Linearization Table is used when the flow input device gives a nonlinear input signal. The unit uses up to 40 different points, as entered by the operator, to form a curve for linearizing the input signal.

Notes:

- 1) A minimum of three points must be set up.
- 2) If "0" is entered for the frequency of any point other than point 1, the Flow Computer assumes there are no more points above the points that preceded them. The display will advance to the next setup prompt.
- 3) If the input frequency is above the highest or below the lowest frequency programmed, the unit will use the last known point for the K factor in computing the resulting actual flow.
- 4) Frequencies, Hz/Cstks or Roshko numbers should be entered in ascending order.

Linearization Table (Pulse Inputs)

7.5.2 Linearization Table for Pulse Inputs

The linearization table for pulse inputs programming is quite simple when values of frequency and K factors are known. The Flow Computer asks for 40 different frequencies (Freq) and 40 corresponding K factors (K). It then uses this data to determine what the actual volume flow rate is for any given input frequency on the respective flowmeter. Usually the necessary data is provided with the flowmeter.

Linearization Table Interpolation

7.5.3 Linearization Table Interpolation

The Linearization Table routine uses the entered data to determine the K factor for any given input frequency or input flow signal. This is done by taking the closest data points above and below the input signal, then using those points to interpolate the K factor, then calculating the uncompensated volume flow from the data. Below are the formulas.

Parameters:

Determine closest point above input signal
 signal = X, K factor (correction factor) = KA

Determine closest point below input signal
 signal = Y, K factor (correction factor) = KB

Let input signal = H,
 unknown K factor (correction factor) = KN

To find KN use this formula:

$$\frac{H - Y}{X - Y} \times (KA - KB) + KB = KN$$

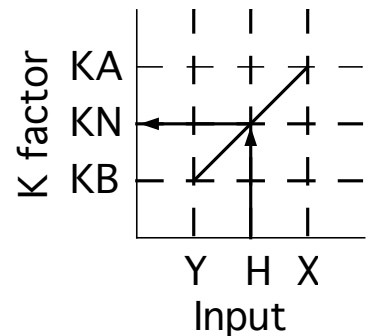

Universal Viscosity Curve

7.6 Universal Viscosity Curve (UVC)

A Universal Viscosity Curve is a presentation of the calibration of a turbine flowmeter's K-Factor as a function of the Hz/cstks. It is used to represent the combined effects of flowrate and viscosity on the calibration of the flowmeter. It is entered as a table of point pairs in ascending order of Hz/cstks.











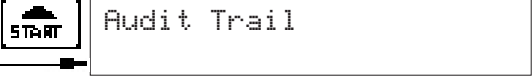

Strouhal Roshko Curve

7.7 Strouhal Roshko Curve (StRo)

A Strouhal Roshko Curve is a presentation of the calibration of a turbine flowmeter's calibration as a table or curve of Strouhal number as a function of Roshko number. It is used to represent the combined effects of flowrate, flowing temperature and viscosity on the calibration of the turbine flowmeter. It is entered as a table of point pairs in ascending order of Roshko numbers.

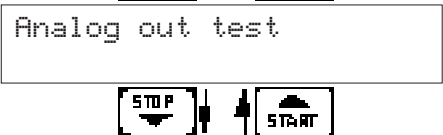
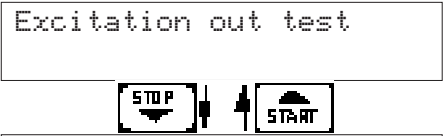
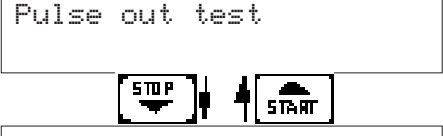

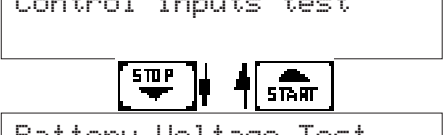
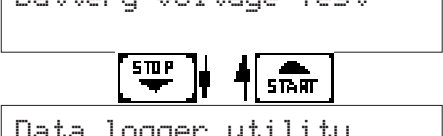

8. Test, Service and Maintenance

8.1 Test Menus



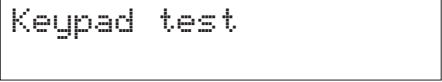

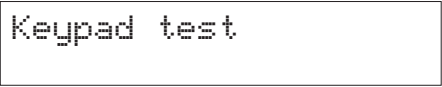
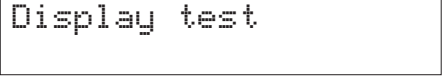

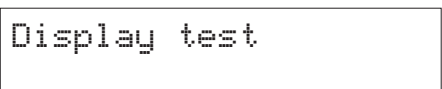

Menus	Display	Notes
8.1.1 TOP LEVEL TEST MENU		<p>Select Test to enter the instrument test & calibration routine. NOTE: Supervisor (Service) password required to gain access to this mode.</p>
		Refer to Page 40 for Details.
		Refer to Page 40 for Details.
		Refer to Page 40 for Details.
		Refer to Page 41 Details.
		Refer to Page 41 for Details.
		Refer to Pages 42-46 for Details.
		Refer to Page 46 Details.
		Refer to Page 47 for Details.
		Refer to Page 47 for Details.
		Refer to Page 47 for Details.
		Refer to Page 48 for Details.
		Refer to Page 48 for Details.
		Refer to Page 48 for Details.
		Refer to Page 49 for Details.
		Refer to Page 49 for Details.





8.2 Test Sub-Menus





Sub-menus	Display	Notes
8.2.1 Audit Trail Submenu Group	<pre>Audit Trail</pre>	Press Enter to view the audit trail information.
	<pre> Config_Audit nnnnn hh:mm:ss dd/mm/yy </pre>	The configuration audit trail format: nnnnn= number of critical menu changes, hh:mm:ss; mm/dd/yy = time and date of last change.
	<pre> Cal_Audit nnnnn hh:mm:ss dd/mm/yy </pre>	The calibration audit trail format: nnnnn= number of calibration changes, hh:mm:ss; dd/mm/yy = time and date of last change.
	<pre>Audit Trail</pre>	Press Menu to get back to audit trail top-level menu.
8.2.2 Error History Submenu Group	<pre>Error history</pre>	Press Enter to view error history. NOTE: Press Print Key to print Error History. Printout will include time/date of each errors first occurrence.
	<pre> Error history Flow rate alarm low </pre>	Press Up/Down arrow keys to scroll through all error message history. Press CLEAR to clear entire error log.
	<pre>Error history</pre>	Press Menu to get back to error history top-level menu.
8.2.3 Print System Setup Submenu Group	<pre>Print System Setup</pre>	Press enter key to enter print system setup submenu
	<pre> Print System Setup Press ENTER to print </pre>	Press enter to begin printing the system setup.
	<pre> Print System Setup -- Printing --- </pre>	This message will display as the data transmission takes place.
	<pre>Print System Setup</pre>	Press Menu to get back to print system setup top-level menu.







Sub-menus	Display	Notes
8.2.4 Keypad test Submenu Group		Press Enter to enter keypad test
		Press the various keys and the display will show the key that was pressed. Press Menu to exit the test
		Press Menu to get back to Keypad test top-level menu.
8.2.5 Display test Submenu Group		Press Enter to enter display test.
		Upon pressing enter, each digit on the display will scroll 0-9 then A-Z. Press menu to exit the test.
		Press Menu to get back to Display test top-level menu.









ALL UNITS ARE CALIBRATED AT THE FACTORY PRIOR TO SHIPMENT
CAUTION:
 This unit must be calibrated using precision and calibrated equipment.
 Equipment needed is as follows: Frequency Generator, Digital Multimeter,
 Precision Current/Voltage Source, Oscilloscope, Frequency Counter.

<u>Sub-menus</u>	<u>Display</u>	<u>Notes</u>
Calibration Submenu Group	<div style="border: 1px solid black; padding: 5px; width: fit-content; margin: 0 auto;">Calibrate</div> 	Press Enter to begin the calibration routine. (Please note the caution above)
8.2.6 Calibrate Aux1: 0mA Submenu Group	<div style="border: 1px solid black; padding: 5px; width: fit-content; margin: 0 auto;">Calibrate Aux1: 0mA Iin=TB1-7 GND=TB1-4</div> 	Connect Current Source (+) TB1-7, (-) TB1-4. Input 0mA and press Enter.
	<div style="border: 1px solid black; padding: 5px; width: fit-content; margin: 0 auto;">Calibrate Aux1: 0mA CALIBRATING --</div>	This message is displayed during calibration.
		
	<div style="border: 1px solid black; padding: 5px; width: fit-content; margin: 0 auto;">Calibrate Aux1: 0mA *** DONE ***</div>	This message is displayed when the 0mA calibration is finished.
		
	<div style="border: 1px solid black; padding: 5px; width: fit-content; margin: 0 auto;">Calibrate Aux1: 0mA Iin=TB1-7 GND=TB1-4</div> 	The display will automatically return to the Calibrate Aux1 0mA submenu. Press the Down arrow key to advance to the Aux1 20mA calibration.
8.2.7 Calibrate Aux1: 20mA Submenu Group	<div style="border: 1px solid black; padding: 5px; width: fit-content; margin: 0 auto;">Calibrate Aux1: 20mA Iin=TB1-7 GND=TB1-4</div> 	Connect Current Source (+) TB1-7, (-) TB1-4. Input 20mA and press Enter.
	<div style="border: 1px solid black; padding: 5px; width: fit-content; margin: 0 auto;">Calibrate Aux1: 20mA 0 CALIBRATING --</div>	This message is displayed during calibration.
		
	<div style="border: 1px solid black; padding: 5px; width: fit-content; margin: 0 auto;">Calibrate Aux1: 20mA *** DONE ***</div>	This message is displayed when the 20mA calibration is finished.
		
	<div style="border: 1px solid black; padding: 5px; width: fit-content; margin: 0 auto;">Calibrate Aux1: 20mA Iin=TB1-7 GND=TB1-4</div> 	The display will automatically return to the Calibrate Aux1 20mA submenu. Press the Down arrow key to advance to the Aux2 0mA calibration.
	<p>Advance to Calibrate Aux2: 0mA</p>	

Sub-menus	Display	Notes
8.2.8 Calibrate Aux2: 0mA Submenu Group	<pre>Calibrate Aux2: 0mA Iin=TB1-8 GND=TB1-4</pre> 	To Calibrate: Connect Current Source (+) TB1-8, (-) TB1-4. Input 0mA and press Enter.
	<pre>Calibrate Aux2: 0mA 0 CALIBRATING --</pre>	This message is displayed during calibration.
	<pre>Calibrate Aux2: 0mA *** DONE ***</pre>	This message is displayed when the 0mA calibration is finished.
	<pre>Calibrate Aux2: 0mA Iin=TB1-8 GND=TB1-4</pre> 	The display will automatically return to the Calibrate Aux2 0mA submenu. Press the Down arrow key to advance to the AUX2 20mA calibration.
8.2.9 Calibrate Aux2: 20mA Submenu Group	<pre>Calibrate Aux2: 20mA Iin=TB1-8 GND=TB1-4</pre> 	To Calibrate: Connect Current Source (+) TB1-8, (-) TB1-4. Input 20mA and press Enter.
	<pre>Calibrate Aux2: 20mA 0 CALIBRATING --</pre>	This message is displayed during calibration.
	<pre>Calibrate Aux2: 20mA *** DONE ***</pre>	This message is displayed when the 20mA calibration is finished.
	<pre>Calibrate Aux2: 20mA Iin=TB1-8 GND=TB1-4</pre> 	The display will automatically return to the Calibrate Aux2 20mA submenu. Press the Down arrow key to advance to the calibrate 0mA output menu.
<p style="text-align: center;">Advance to Cal Therm: 100 Ohms</p>		











Sub-menus	Display	Notes
8.2.10 Cal Therm: 100 Ohms Submenu Group	<pre>Cal Therm: 100 Ohms Therm TB1-6 to TB1-4</pre> 	To Calibrate: Place a 100 ohm 0.1% resistor between TB1-6 and TB1-4. Press enter to calibrate.
	<pre>Cal Therm: 100 Ohms 0 CALIBRATING --</pre>	This message is displayed during calibration.
	<pre>Cal Therm: 100 Ohms *** DONE ***</pre>	This message is displayed when the calibration is finished.
	<pre>Cal Therm: 100 Ohms Therm TB1-6 to TB1-4</pre>  <p>Advance to Cal Therm: Open</p>	The display will automatically return to the Cal Therm: 100 Ohms top-level menu. Press the Down arrow key to advance to the Thermistor Open calibration.
8.2.11 Cal Therm: Open Submenu Group	<pre>Cal Therm: Open Therm TB1-6 to TB1-4</pre> 	To Calibrate: Remove the 100Ω 0.1% resistor from TB1-6 and TB1-4 and leave open. Press enter to calibrate.
	<pre>Cal Therm: Open 0 CALIBRATING --</pre>	This message is displayed during calibration.
	<pre>Cal Therm: Open *** DONE ***</pre>	This message is displayed when the calibration is finished.
	<pre>Cal Therm: Open Therm TB1-6 to TB1-4</pre>  <p>Advance to Calibrate Aux2: 0V</p>	The display will automatically return to the Cal Therm Open top-level menu. Press the Down arrow key to advance to the Aux2: 0V calibration.

Sub-menus	Display	Notes
8.2.12 Calibrate Aux2: 0V Submenu Group	<pre>Calibrate Aux2: 0V Vin=TB1-5 GND=TB1-4</pre> 	To Calibrate: Connect Voltage Source (+) TB1-5, (-) TB1-4. Input 0V and press Enter.
	<pre>Calibrate Aux2: 0V 0 CALIBRATING --</pre>	This message is displayed during calibration.
	<pre>Calibrate Aux2: 0V *** DONE ***</pre>	This message is displayed when the 0V calibration is finished.
	<pre>Calibrate Aux2: 0V Iin=TB1-5 GND=TB1-4</pre> 	The display will automatically return to the Calibrate Aux2 0V top-level menu. Press the Down arrow key to advance to the Aux2 10V calibration.
8.2.13 Calibrate Aux2: 10V Submenu Group	<pre>Calibrate Aux2: 10V Iin=TB1-5 GND=TB1-4</pre> 	To Calibrate: Connect Voltage Source (+) TB1-5, (-) TB1-4. Input 10V and press Enter.
	<pre>Calibrate Aux2: 10V 0 CALIBRATING --</pre>	This message is displayed during calibration.
	<pre>Calibrate Aux2: 10V *** DONE ***</pre>	This message is displayed when the 10V calibration is finished.
	<pre>Calibrate Aux2: 10V Iin=TB1-5 GND=TB1-4</pre> 	The display will automatically return to the Calibrate Aux2 10V top-level menu. Press the Down arrow key to advance to the 100 ohm RTD calibration.
Advance to Cal RTD 100ohm		
8.2.14 Calibrate 100 ohm RTD Submenu Group	<pre>Cal RTD 100ohm JMP TB1-6,7 100R=7,8</pre> 	To Calibrate: Connect a jumper wire between TB1-6 and TB1-7, Place a 100 ohm 0.1% resistor between TB1-7 and TB1-8. Press enter to calibrate.
	<pre>Cal RTD 100ohm 0 CALIBRATING --</pre>	This message is displayed during calibration.
	<pre>Cal RTD 100ohm *** DONE ***</pre>	This message is displayed when the RTD calibration is finished.
	<pre>Cal RTD 100ohm JMP TB1-6,7 100R=7,8</pre> 	The display will automatically return to the Calibrate 100 ohm RTD top-level menu. Press the Down arrow key to advance to the 0mA analog out calibration.
Advance to Calibrate 0mA Aout		



Sub-menus	Display	Notes
8.2.15 Calibrate 0mA Aout Submenu Group	Calibrate 0mA Aout + TB1-15 - TB1-16	Connect ammeter to (+) TB1-15, (-) TB1-16. Press enter.
	 Calibrate 0mA Aout Enter mA: 0.00000	To trim 0mA analog output: Press CLEAR to enable editing and enter a small negative number (i.e. -0.100) to force a display reading, then clear and enter small quantity measured on your meter.
	 Calibrate 0mA Aout + TB1-15 - TB1-16 	The display will return to Calibrate 0mA out. Press the down arrow key to advance to the 20mA analog out or repeat above if necessary.
8.2.16 Calibrate 20mA Aout Submenu Group	Calibrate 20mA Aout + TB1-15 - TB1-16	Connect ammeter to (+) TB1-15, (-) TB1-16. Press enter.
	 Calibrate 20mA out Enter mA: 20.00000	To trim 20mA analog output: Press CLEAR to enable editing and enter the current reading that is on the ammeter display. Press enter.
	 Calibrate 20mA Aout + TB1-15 - TB1-16 	The display will automatically return to the Calibrate 20mA Aout submenu. Calibration is complete.
	Calibrate	Press the Menu key to go back to Calibrate top-level menu.
8.2.17 Analog In Test Submenu Group	Analog In Test	Press enter to test the analog inputs.
	 Analog In Test mA T7:00.000 T8:00.000 	To check current input accuracy: Use TB1-4 as Reference Ground, input 0-20mA to TB1-7 and/or TB1-8. Display should show current being input. Use ammeter to verify input. Use Up/Down arrow keys to check other inputs.
	Analog In Test	Press Menu key to return to Analog In Test top-level menu.

NOTE:

Press the $\Delta \nabla$ keys for additional analog input tests for RTD, Thermistor, and Voltage on terminal 5. Connect only one signal type at a time based on the Analog Input test being performed.

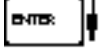
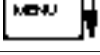
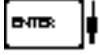
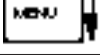
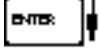
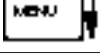
Sub-menus	Display	Notes
8.2.18 Pulse input test Submenu Group	<div style="border: 1px solid black; padding: 5px; text-align: center;">Pulse input test</div>	Press Enter key to test the pulse input.
2.5V 10mV 100mV 	<div style="border: 1px solid black; padding: 5px; text-align: center;"> ENTER:  Pulse input test Trigger level 2.5V ENTER:  </div>	Use the Up/Down arrow keys to select the appropriate trigger level.
40Hz 3KHz 20kHz 	<div style="border: 1px solid black; padding: 5px; text-align: center;"> Pulse input test count speed 3kHz ENTER:  </div>	Use the Up/Down arrow keys to select the appropriate frequency range.
	<div style="border: 1px solid black; padding: 5px; text-align: center;"> Pulse input test F1: 0 F2: 0 MENU:  </div>	To check Pulse input accuracy at the above settings: Use TB1-4 as reference ground, input a frequency on TB1-2 and/or TB1-3. The display should show frequency being input. Use a frequency counter to verify input.
	<div style="border: 1px solid black; padding: 5px; text-align: center;">Pulse input test</div>	Press Menu key to return to Pulse input test top-level menu.
8.2.19 Analog out test Submenu Group	<div style="border: 1px solid black; padding: 5px; text-align: center;">Analog out test</div>	Press Enter to test the analog output.
	<div style="border: 1px solid black; padding: 5px; text-align: center;"> ENTER:  Analog out test *0 4 10 15 20 mA MENU:  </div>	To simulate analog output: Connect an ammeter to (+) TB1-15, (-) TB1-16. Press the key under the desired setting to move the asterisk (*). The unit should output the selected current.
	<div style="border: 1px solid black; padding: 5px; text-align: center;">Analog out test</div>	Press Menu key to return to Analog out test top-level menu.
8.2.20 Excitation out test Submenu Group	<div style="border: 1px solid black; padding: 5px; text-align: center;">Excitation out test</div>	Press Enter to test the excitation output.
	<div style="border: 1px solid black; padding: 5px; text-align: center;"> ENTER:  Excitation out test *5v 12v 24v MENU:  </div>	To test the excitation output: Connect a voltmeter to (+) TB1-1, (-) TB1-4. Press the key under the desired setting to move the asterisk (*). The unit should output the selected voltage.
	<div style="border: 1px solid black; padding: 5px; text-align: center;">Excitation out test</div>	Press Menu key to return to Excitation out test top-level menu.

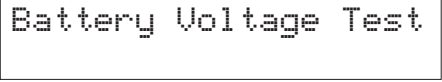
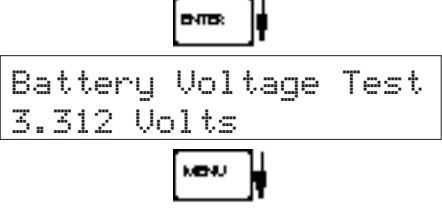
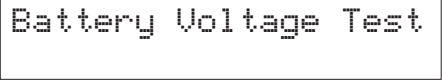
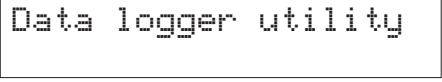
Sub-menus	Display	Notes
8.2.21 Pulse out test Submenu Group	Pulse out test	Press Enter key to test the pulse output.
	 Pulse out test *0Hz 1Hz 10Hz 20Hz	To simulate a frequency on the pulse output: Connect a frequency counter to (+)TB1-13, (-)TB1-14. Press the key under the desired setting to move the asterisk (*). The unit should output the selected frequency.
	 Pulse out test	Press Menu key to return to Pulse out test top-level menu.
8.2.22 Relay test Submenu Group	Relay Test	Press Enter to test the relays.
	 R1y1 R1y2 R1y3 R1y4 Off Off Off Off	To manually control the relay outputs: Press the key under the desired relay to toggle the relays On/Off. Use an ohmmeter to check the relay contacts.
	 Relay Test	Press Menu key to return to Relay Test top-level menu.
8.2.23 Control input test Submenu Group	Control inputs test	Press Enter to test the control inputs.
	 TB1-9 TB1-10 TB1-11 Off Off Off	To check the control inputs: Use TB1-12 as reference, input a positive 3-30 VDC signal to TB1-9, TB1-10 and/or TB1-11, The Display will show ON when input is active, OFF when inactive.
	 Control inputs test	Press Menu key to return to control input test top-level menu.

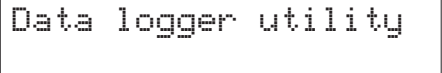
Sub-menus	Display	Notes
8.2.24 Battery Voltage test Submenu Group		Press Enter key to view the battery voltage.
		The display will show the battery voltage. Replace battery at 2.5 VDC or below.
		Press Menu key to return to battery voltage test top-level menu.
8.2.25 Data logger utility Submenu Group		Press Enter to use data logger utility.
		The displays shows the number of Data Logs. Press the Down arrow key to advance to PRT (print) or CLR (clear).
		Press F3 PRINT key to output data logger logs to printer, Press CLEAR key to clear the data logger contents.
		Press Menu key to return to Data logger utility top-level menu.

8.3 Internal Fuse Replacement

Instructions:

1. Make sure you follow proper E.S.D. Precautions. All persons performing this replacement must follow proper grounding procedures.
2. Turn the power to the unit off.
3. Disconnect the two piece connector rear terminal block, leaving all connections in place.
4. Remove the unit from the panel.
5. Remove the four machine screws (see fig. 1) which hold the two sections of the case together.
6. The rear section of the case should detach from the rest of the case. It may be necessary to cut the wiring label along the joint where the two sections connect. With the rear section of the case removed the fuse will be exposed (located near the rear terminal, AC connection).
7. Locate the Fuse F1 (see fig. 2) and unplug the fuse from its socket.
8. Insert the new fuse into the socket. Insure that the pins are fully inserted and straight.
9. Reassemble the case and install the four machine screws which join the two sections of the case.
10. Reinstall the unit into the panel.
11. Reconnect the rear terminal block.
12. Turn the unit back on.

Fuse Specifications:

- | | | |
|------------------|----------------|-----------------------------------|
| 110 VAC Power: | 160mA/250V, TD | Wickman 19372-030-k or equivalent |
| 220 VAC Power: | 80mA/250V, TD | Wickman 19372-026-k or equivalent |
| 12/24 VDC Power: | 800mA/250V, TD | Wickman 19374-046-k or equivalent |

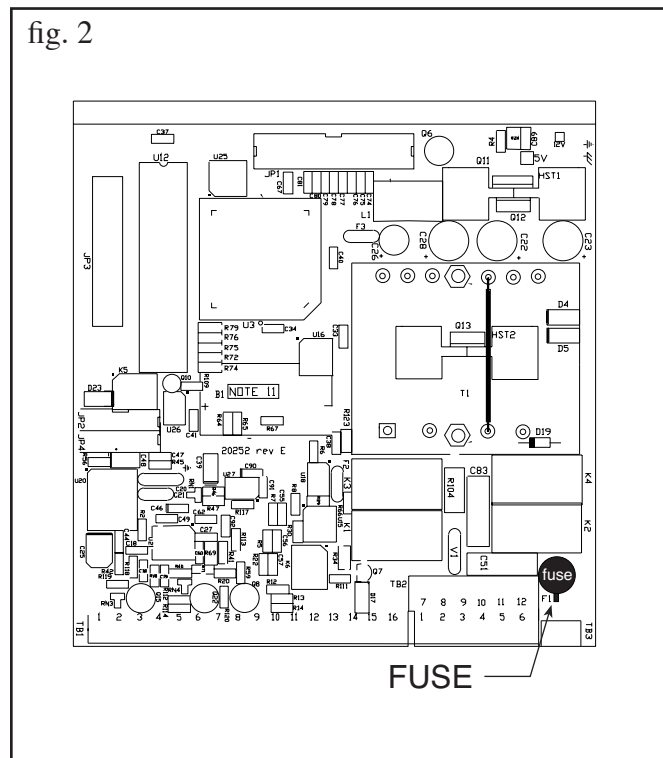
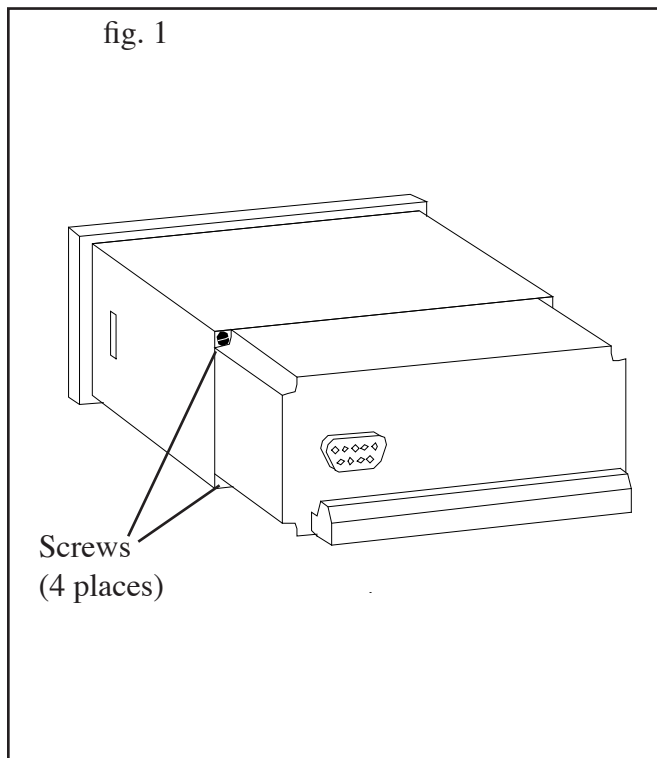

9. RS-232 Serial Port

9.1 RS-232 Port Description:

The 923-ST1NET-FC has a general purpose RS-232 Port which may be used for any one of the following purposes:

- Transaction Printing
- Data Logging
- Remote Metering by Modem (optional)
- Computer Communication Link
- Configuration by Computer
- Print System Setup
- Print Calibration/Malfunction History

9.2 Instrument Setup by PC's over Serial Port

A Diskette program is provided with the 923-ST1NET-FC that enables the user to rapidly configure the 923-ST1NET-FC using a Personal Computer. Included on the diskette are common instrument applications which may be used as a starting point for your application. This permits the user to have an excellent starting point and helps speed the user through the instrument setup.

9.3 Operation of Serial Communication Port with Printers

923-ST1NET-FC's RS-232 channel supports a number of operating modes. One of these modes is intended to support operation with a printer in metering applications requiring transaction printing, data logging and/or printing of calibration and maintenance reports.

For transaction printing, the user defines the items to be included in the printed document. The user can also select what initiates the transaction print generated as part of the setup of the instrument. The transaction document may be initiated via a front panel key depression or upon a remote contact closure.

In data logging, the user defines the items to be included in each data log as a print list. The user can also select when or how often he wishes a data log to be made. This is done during the setup of the instrument as either a time of day or as a time interval between logging.

The system setup and maintenance report list all the instrument setup parameters and usage for the current instrument configuration. In addition, the Audit trail information is presented as well as a status report listing any observed malfunctions which have not been corrected. The user initiates the printing of this report at a designated point in the menu by pressing the print key on the front panel.

9.4 923-ST1NET-FC RS-232 Port Pinout

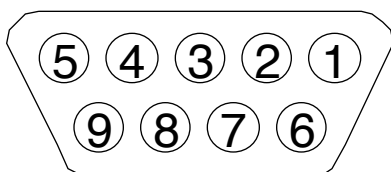

- 1 Handshake Line
- 2 Transmit
- 3 Receive
- 4 Optional Modem Power Out (+)
- 5 Ground
- 6 Optional Modem Power Out (+)
- 7 Do Not Use
- 8 Do Not Use
- 9 Do Not Use

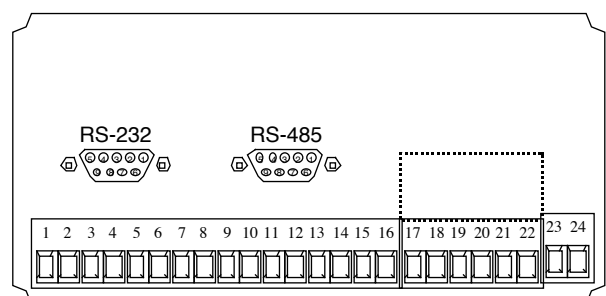

10. RS-485 Serial Port (optional)

10.1 RS-485 Port Description:

The 923-ST1NET-FC has a an optional general purpose RS-485 Port which may be used for any one of the following purposes:

Accessing Process Parameters

Net, Supply, Return Rate, Temperatures, Densities, Viscosities, Set-points, Month, Day, Year, Hour, Minutes, Seconds, etc.

Accessing System Alarms

System, Process, Self Test, Service Test Errors

Accessing Totalizers

Net, Supply, Return Totalizers and Grand Totalizers

Executing Various Action Routines

Reset Alarms, Reset Totalizers, Print Transaction, Reset Error History

10.2 General

The optional RS-485 card utilizes Modbus RTU protocol to access a variety of process parameters and totalizers. In addition, action routines can be executed. See Appendix C for further information and details on this option.

10.3 Operation of Serial Communication Port with PC

The flow computer's RS-485 channel supports a number of Modbus RTU commands. Refer to port pinout (below) for wiring details. Modbus RTU drivers are available from third party sources for a variety of Man Machine Interface software for IBM compatible PC's.

The user reads and writes information from/to the RS-485 using the Modbus RTU commands. The 923-ST1NET-FC then responds to these information and command requests.

Process variables and totalizers are read in register pairs in IEEE 32 bit floating point format. Time and date are read as a series of integer register values. Alarms are individually read as coils. Action routines are initiated by writing to coils.

10.4 923-ST1NET-FC RS-485 Port Pinout

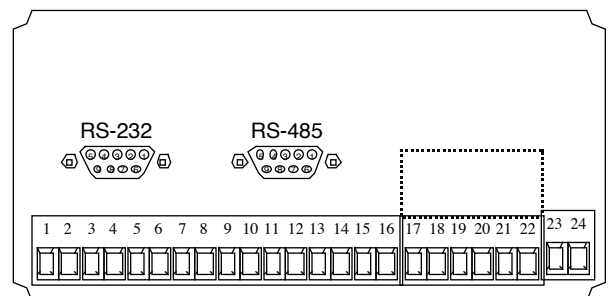
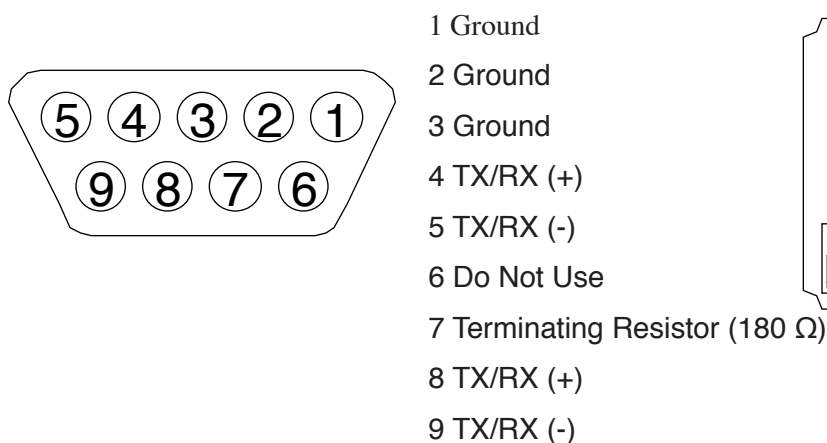

NOTE: To terminate cable end, connect Pin 7 to either Pin 4 or Pin 8.

11. Flow Computer Setup Software

The 923-ST1NET-FC setup program provides for configuring, monitoring and controlling a 923-ST1NET-FC unit over the RS-232 link.

Sample applications are stored in disk files. The setup program calls these *Templates*. You can store the setup from the program's memory to either the 923-ST1NET-FC (*Downloading* the file) or to a disk file (*Saving* the file) for later usage. Similarly you can load the setup in program memory from either a disk file (*Opening* a file) or from the 923-ST1NET-FC unit (*Uploading* a file).

The program can monitor outputs from the unit while it is running.

The program can reset alarms and totalizers.

For assistance there are mini-helps at the bottom of each screen in the program. There is also context sensitive help available for each screen accessible by pressing the F1 key.

11.1 System Requirements:

IBM PC or compatible with 386 or higher class microprocessor

4 MB RAM

3 MB free disk space

VGA or higher color monitor at 640 x 480

Microsoft® Windows 95™ up through Vista 32

Communication Port - RS-232 mapped to COM 1-9

RS-232 Cable or compatible RS232 to USB converter

11.2 Cable and Wiring Requirements:

The serial communication port on your PC is either a 25 pin or 9 pin connector. No cabling is supplied with the setup software. A cable must be purchased separately or made by the user. It is recommended to purchase a cable which matches the available communication port on you PC and a 9 pin male connection for the 923-ST1NET-FC serial port.

11.3 Installation for Windows 95™ or higher

The Setup Software includes an installation program which installs the software to your hard drive. The setup software may be supplied on a CD or downloaded from our website.

Insert Setup CD in CD drive.

NOTE: For Windows 95™ Click the Start button, select Run and proceed as follows:

Type the floppy drive letter followed by a colon (:), and a backslash (\), and the word setup. For Example:

a:\setup

Follow the instructions on your screen.

In most cases the program will perform an auto-install once the CD is inserted in the drive. Note that the program needs to be run as an administrator on some Windows operating systems.

11.4 Using the Flow Computer Setup Software

The setup software window consists of several menu “Tabs”. Each tab is organized into groups containing various configuration and/or monitoring functions. To view the tab windows, simply click on the tab. The previous tab window will be hidden as the new tab window is brought to the foreground.

11.5 File Tab

The File Tab has three sections. Any of the options on this tab can also be accessed from the File submenu.

The **Template Section** provides for opening and saving templates. The *Save* and *Save As* buttons provide the standard Windows functionality for dealing with files. The *Open* button is used to open existing templates or files.

There are two additional menu items available *only* from the pull down File menu: *Open existing file* and *Templates*.

The *Open existing file*, option allows for creating custom templates using one of the existing template in memory as the starting point. Assign a new name for this new template. The template will be saved under this new name.

The *Open Template* option will bring up a list of predefined templates that can be loaded into the program. These predefined templates are useful as a starting point when defining custom templates.

A typical scenario using the setup program would be the following:

- Open up a predefined template from the supplied list
- Choose ‘Save As’ to save this to a new file name
- Proceed to customize the template by making any changes that are needed
- Save the setup to disk (if you want to reuse this template)
- Download the template to an attached unit.

The **Communications with 923-ST1NET-FC Section** allows the user to upload the setup from the unit or download the setup to the unit.

The **Print (report) Section** allows the user to:

1. Configure the current Windows printer through the Select Printer option.
2. Print a Maintenance Report through the PC's printer using the Print Maintenance option.
3. Print the current setup through the PC's printer using Print Setup option.

11.6 Setup Tab

The Setup tab is where majority of the 923-ST1NET-FC instrument setup modifications are done. The Setup tab is divided into five sections.

System Section: Flow Equation, Indicators

Input Section: Flow, Fluid, Aux 1 & 2 (Compensation Inputs 1 & 2),
Control Inputs

Output Section: Pulse, Currents

Relay Section: Relays 1, 2, 3, 4

Other Settings Section: Administration, Communication, Serial Usage,
Datalog Printing, Time Clock

NOTE: Many setup items are enabled or disabled depending on previous setup selections, It is important to work your way through the above list in the order shown. Be sure to verify your selections when you are through programming to insure that no settings were changed automatically.

11.7 View Tab

The View Tab screen allows for viewing selected group items on the PC in a similar format as shown on the unit display. Data from the following groups can be viewed in the List of Values section:

Process Parameters (i.e. rate, temperature)

Totalizers (i.e. total, grand total)

Error Log

Software Version

The setup software assumes the current setup has been uploaded from the flow computer into the PC. It is important that the setup program and the 923-ST1NET-FC unit are using the same setup information at all times or the data will be inconsistent. It is best to upload or download the setup before using this feature.

To start the viewer, first check the boxes of items to view and then click the start button. The data will appear in the appropriate sections and will be continuously updated. The refresh rate is dependent on the number of items that are being viewed and the baud rate of the connection. Data in the List of Values section can be collapsed by clicking on the 'minus' sign in front of the group title. The data can be expanded by clicking on the 'plus' sign in front of the group title. If a group is collapsed and data in the group changes on refresh, the group will automatically expand. Changing the view items requires stopping the current viewing, checking the new selections and then restarting the viewer.

If communication errors occur while reading data from the 923-ST1NET-FC device, the word 'Error' will appear in place of the actual value. If the connection to the 923-ST1NET-FC is lost, the viewer will time out with a message saying the device is not responding.

The viewer will attempt to communicate with the 923-ST1NET-FC device matching the device ID set in the communications screen. If you are having trouble establishing communication, compare settings for the PC and the flow computer. Also verify the connections between the PC and flow computer.

11.8 Misc. Tab

This tab has three sections: Tools, Actions and Options.

The tools section contains various system administration activities such as creating/modifying the initial sign-on screen.

Create Sign-on and Create Print Header

The Actions section is used to send commands to the 923-ST1NET-FC unit.

Reset Totalizers, Reset Alarms, Reset Alarm History

The Options section has the following selections:

Network Card Setup

Additional capabilities may be provided in the future.

NOTE: Future options appear as disabled buttons on the screen.

12. Glossary Of Terms

Acknowledge & Clear Alarms

Acknowledge is used to clear alarm relays and remove any visual alarm messages from the display. In the run mode, press the ENTER key or activate CONTROL INPUT 3 (if set for ACK) to momentarily clear alarms and alarm messages. Alarms will reassert themselves if alarm conditions are still present.

Analog Output

The analog signal (4-20mA) that is generated by the 923-ST1NET-FC. It can correspond to the Net Flow Rate or Total. This output is used primarily for transmission of process information to remote systems.

Audit Trail

The audit trail is used to track the number of changes made to the units setup program.

Baud Rate

The speed of serial communication transmissions, expressed in bits per second.

Calibration Temperature

The temperature at which a flow sensor was calibrated on a test fluid.

C-Factor (Fluid Expansion Factor)

A parameter in a flow equation which is used to describe the relationship between density or volume and temperature changes.

Corrected Volume Flow

The equivalently volume at a reference temperature condition which involves the measurement of liquid volume flow using a flow sensor and temperature sensor to compensate for thermal expansion.

Custody Transfer

Weights and Measure metering codes often specify several requirements for instruments and mechanisms to prevent and track changes in the setup of an instrument which may be used in the commercial sale of goods. The 923-ST1NET-FC tracks changes via the Audit Trail.

Data Logger

The capturing of information for later use and the mechanism for specifying the conditions where a capture should be made.

DC Output / Excitation Voltage

An on-board DC power supply used to power peripheral sensors. The 923-ST1NET-FC offers excitation voltages of 5VDC, 12VDC or 24VDC when powered by AC voltage.

Default Value

The value to be used by the instrument if a sensor failure or out of range signal is detected.

Expansion Factor

See C-Factor

Flow Alarm

A visual indication that the volumetric flowrate is above or below the flow alarm setpoint specified by the user.

Flow Balance Factor

The flow balance factor is a scaling constant that may be used to "trim" the return flow meter calibration by a small factor to eliminate any observed small "net" metering difference between supply and return when fuel is being circulated but not actually being consumed.

Small differences can occur in some piping installations. Such installation issues may otherwise result in small differences in the calibration between the supply and return flow meter. Flow Balance Factor Values between .99 and 1.01 might be considered within the normal range when differences between supply and return flow rates can not otherwise be explained

12. Glossary Of Terms (Continued)

Flow Equation

A recognized relationship between the process parameters for flow, temperature, pressure and density used in flow measurements.

Follow, Alarm

Alarm relays which are non latching and whose output state is based solely on the comparison of the current process value and the alarm setpoint (trip point).

Function Key

A key on a push-button panel or keyboard (whose function is described by the key label) used to perform an instrument function or special routine.

Handshake

A means of controlling the information flow between two pieces of equipment to prevent the sending device from transmitting information at a rate faster than what can be accepted by the receiver.

Hysteresis

The relay hysteresis is a "dead band" setting which allows the relay to remain energized for a given amount below the setpoint. This is used to prevent relay chatter when the process value is near the setpoint value.

Example: If the Preset is set at 100, and the hysteresis is set at 10, the relay will energize when the rate, temp or dens. reaches 100, the relay will remain energized until the reading falls below 90.

Input Termination

Input signal lines on digital inputs often require pullup or pulldown resistor configurations to operate properly with different sensor configurations. The 923-ST1NET-FC contains such resistors and may be enabled via the setup menu.

Inhibit Totalizer

"*Inhibit Total*" is a Control Input 1 setting that is used to stop the totalization. If enabled, a voltage level on control input 1 will inhibit the total as long as the voltage is present. This feature is useful during meter proving and in applications that provide a sensor to signal the flow computer when fluid is present.

K-Factor

A scaling factor derived from the pulses produced by a flowmeter output, expressed in pulses per unit (i.e. pulses/gallon)

Limit Setpoint

An alarm trip point setting which specifies the value or magnitude of a process parameter necessary to activate an alarm indicator or control relay.

Linear Flowmeter

A flow measurement device whose output is proportional to flow.

Linearization

The mathematical correction of a nonlinear device. The 923-ST1NET-FC uses a linearization Table which is made up of input/output values and makes interpolations of the table to arrive at a "linearized" measurement.

LinTbl

Abbreviation for Linearization Table.

12. Glossary Of Terms (Continued)

Low Pass Filter

A low pass filter passes low input frequencies while blocking high frequencies. In the 923-ST1NET-FC, this is the maximum input count speed to be encountered in an application. It is expressed in counts per second (Hz).

Mass Flow

Mass Flow is inferred by the volumetric flow and density (or implied density) of a fluid.

Max Window

The max. window time sets the maximum sample time (1 to 99 sec) for the ratemeter.

Meter Expansion Coef.

A coefficient in an equation which may be used to correct for changes in flowmeter housing dimensional changes with temperature.

Modem Init Master

The "Modem Init Master" menu allows the user to select whether the unit will engage in a configuration conversation with the modem on power up or impart no setup information to the modem and use it "as is". For most users it is recommended to choose "yes" for "Modem Init Master".

Parity

A method for detecting errors in transmissions of serial communications data.

Preset

A set point used to trigger the relay outputs of the 923-ST1NET-FC.

Print Interval

The print interval allows the 923-ST1NET-FC to transmit information to the serial port at selectable time intervals.

Private Code

An operator password code which authorizes changes to the setup of the instrument but blocks access to the Service/Calibration/Test mode. The private code also blocks the clearing of the Grand Total.

Process Parameters

Any sensor information which has been scaled to engineering units including Flow, Temperature and Density.

Pulldown (Input Termination)

The termination of an input at which the input is pulled down to ground through a resistor. Inputs that are terminated by this method need to be driven high with a positive voltage pulse.

Pullup (Input Termination)

The termination of an input at which the input is pulled up to a positive voltage through a resistor. Inputs that are terminated by this method need to be pulled low with a sinking current or contact to ground .

Pulse Output

The pulse output of the 923-ST1NET-FC is available for remote accumulation of the net total or sent to peripheral devices, such as a PLC. The output can be scaled using the Pulse Output Scaling Constant.

12. Glossary Of Terms (Continued)

Quick Update %

This feature is used to disable the rate averaging filter when a significant change in the flow rate occurs. The user can enter the percent of change needed to be detected to disable the averaging feature. This is especially useful during start-up and shutdown of flow.

Rate Averaging Filter

The rate averaging filter is used to stabilize fluctuating rate displays. Higher settings provide more averaging for a more stable display. Derived from the equation:

$$\frac{(\text{OLD DATA} \times \text{"Avg. Filter"} + \text{NEW DATA})}{(\text{"Avg. Filter"} + 1)}$$

Ratometer

Any device used to display the speed of a process. The ratemeter in the 923-ST1NET-FC displays flow rate.

Ref. Dens.

Abbreviation for Reference Density. This is the fluid density at reference conditions of temperature.

Ref. Temp.

Abbreviation for Reference Temperature. This represents the base or reference condition to which corrected flow will be computed.

Roshko

A parameter defined as: $R_o = \frac{f \cdot \text{temperature correction}}{cstk}$

STP Reference

The users desired pressure and/or temperature to be considered as the reference condition in the computation of fluid properties or corrected volume conditions.

Strouhal

A calibration parameter defined as temperature corrected K-factor for a turbine flowmeter.

Time Constant

A damping factor for an averaging filter for the analog output. (see also Rate Averaging Filter)

Totalizer

Any device which accumulates and displays a total count.

UVC

Abbreviation for Universal Viscosity Curve. A presentation of the combined flowrate/viscosity calibration for a turbine flowmeter.

VFD

Abbreviation for Vacuum Fluorescent Display

Visc Coef

Abbreviation for Viscosity Coefficient. One or more coefficients in an equation used to describe the viscosity as a function of temperature for a fluid.

Volume Flow

The measurement of volumetric flow.

13. Diagnosis and Troubleshooting

13.1 Response of 923-ST1NET-FC on Error or Alarm:

Error and warning indications which occur during operation are indicated in the RUN mode alternately with the measured values. The 923-ST1NET-FC Flow Computer has three types of error:

TYPE OF ERROR	DESCRIPTION
Sensor/Process Alarms	Errors detected due to sensor failure or process alarm conditions
Self Test Errors	Errors detected during self test.
System Alarms	Errors detected due to system failure

Some alarms are self clearing. Other alarms require the user to acknowledge and clear the alarm. Press the ENTER button to acknowledge and clear alarms. Alarms may reassert themselves if the alarm condition is still present.

NOTE: A historical error alarm log is available in the "Test Mode".

The following descriptions suggest possible causes and corrective actions for each alarm message.

13.2 Diagnosis Flow Chart and Troubleshooting

All instruments undergo various stages of quality control during production. The last of these stages is a complete calibration carried out on state-of-the-art calibration rigs.

A summary of possible causes is given below to help you identify faults.

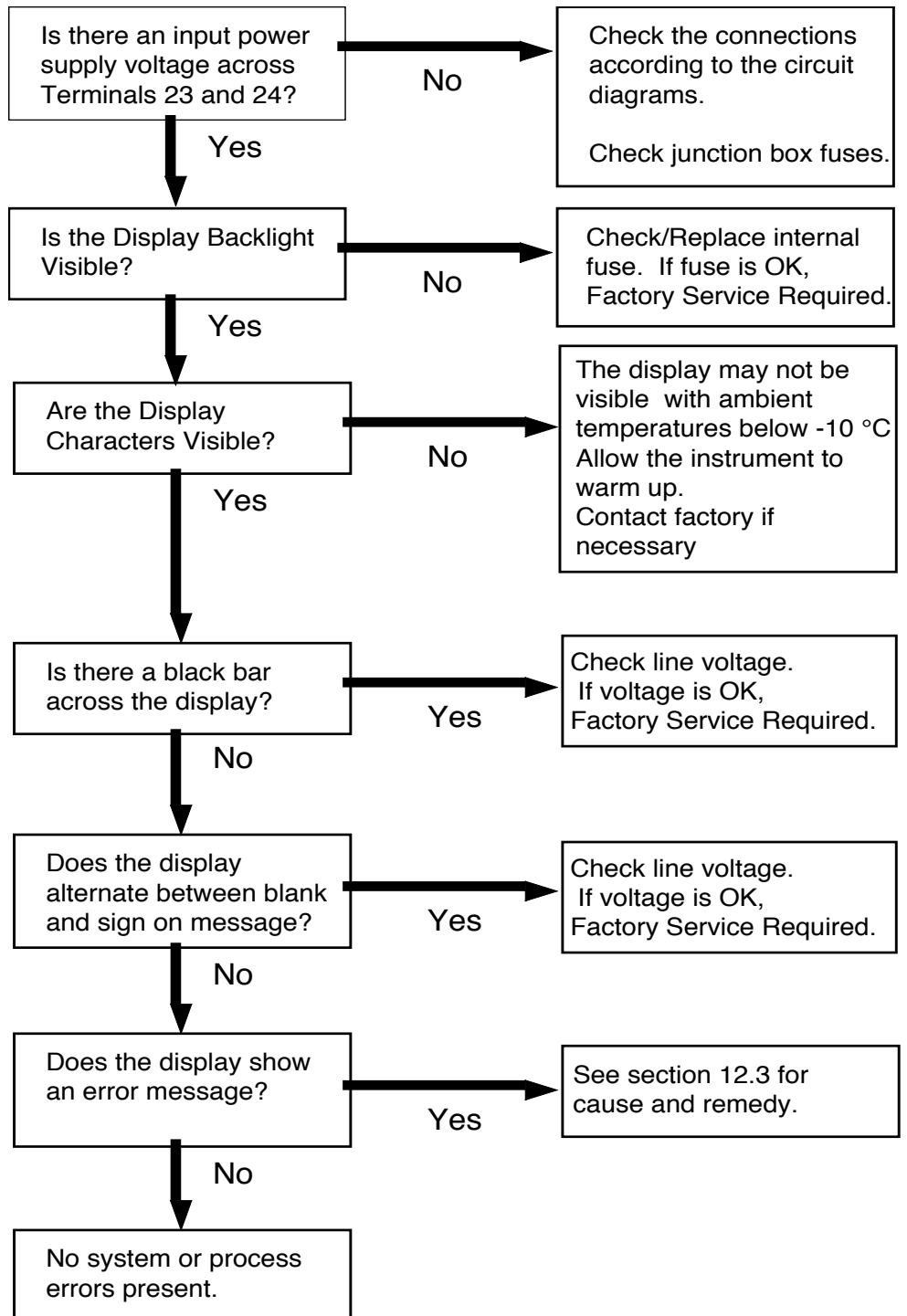

13.3 Error & Warning Messages:

13.3.1 Sensor/Process Alarms

Error/Warning Message	Cause	Remedy
TOTALIZER ROLLOVER	Displayed when totalizer rolls over	Acknowledge Rollover, Remedy not required
AUX INPUT TOO LOW!	4-20 mA Input current at aux input smaller than 3.5 mA: <ul style="list-style-type: none"> • Faulty Wiring • Transmitter not set to "4-20 mA" • Transmitter defective 	<ul style="list-style-type: none"> • Check wiring • Check function of sensor
RATE OVERFLOW ERROR	Pulse counter overflowed. The totalizer may have lost counts.	<ul style="list-style-type: none"> • Report error to factory • Check application conditions • Check wiring
PULSE OUT OVERFLOW	Calculated pulse frequency too large: <ul style="list-style-type: none"> • Pulse width setting too long • Larger pulse scaler needed 	<ul style="list-style-type: none"> • Adjust pulse value • Adjust pulse width • Check process conditions
FLOW RATE 1 LOW ALARM FLOW RATE 1 HIGH ALARM FLOW RATE 2 LOW ALARM FLOW RATE 2 HIGH ALARM NET FLOW RATE LOW ALARM NET FLOW RATE HIGH ALARM TEMP 1 LOW ALARM TEMP 1 HIGH ALARM TEMP 2 LOW ALARM TEMP 2 HIGH ALARM	Limit value exceeded.	<ul style="list-style-type: none"> • Check application if necessary • Check limit value • Adjust the limit value if required
MODEM NOT PRESENT	The setup expects modem usage and a modem is not responding.	<ul style="list-style-type: none"> • Check setup for proper baud rate, parity, etc. • Check modem connection and cycle power to the unit. • Replace modem
SOFTWARE ERROR RESET	Abnormal program execution has occurred. Problem was self diagnosed and logged.	<ul style="list-style-type: none"> • Report error to factory
EXTENDED PFI LOCKUP	Unit was operated with an input power level lower than safe operating range for an extended period of time.	<ul style="list-style-type: none"> • Check data in unit. Totalizer may have inaccuracies • Investigate brownout cause.

13.3 Error & Warning Messages: (Continued)

13.3.2 Self Test Alarms

Error/Warning Message	Cause	Remedy
AUX INPUT TOO HIGH!	Analog input signal of the auxiliary input exceeded by more than 3%: <ul style="list-style-type: none"> • Sensor overranged • Incorrect full scale setting of transmitter • Function error in transmitter or faulty wiring 	<ul style="list-style-type: none"> • Check analog signal range • Check the application conditions • Check wiring
BATTERY LOW WARNING	Battery voltage too low	<ul style="list-style-type: none"> • Replace Battery • Consult Factory for service information
A to D NOT CONVERTING	Fault in analog/digital converter	<ul style="list-style-type: none"> • Unit may self correct, Press ENTER to acknowledge & clear alarm • If error reasserts, factory service is required
TIME CLOCK ERROR	The correct time/date is no longer shown	<ul style="list-style-type: none"> • Re-enter time and date. • If error occurs again contact factory
CAL CHECKSUM ERROR	Calibration constants have been corrupted	<ul style="list-style-type: none"> • Report error to factory
SETUP CHECKSUM ERROR	The units setup has been corrupted	<ul style="list-style-type: none"> • Report error to factory

Appendix A**Fluid Properties Table****LIQUID**

FLUID	REF. DENSITY (lb./gal)	REF. TEMP. (°F)	COEFF. OF EXPANSION (e-6 format)	LIQ.VISC. ANDRADE's EQUATION COEFF. "A"	VISCOSITY BY ANDRADE's EQUATION COEFF. "B"
GASOLINE	6.2572	60	370.3	0.045617	1432.26
KEROSENE	6.9243	60	268.1	0.004378	3245.78
No. 2 FUEL	7.8843	60	88.5	0.000453	4946.15

Appendix B

923-ST1NET-FC SETUP MENUS

START HERE

SELECT FLOW EQUATION	SELECT FLOW EQUATION	DENS EXTRACT METHOD	FLOW BALANCE FACTOR	TEMPERATURE SCALE	TEMPERATURE DEC PLACES	TEMPERATURE DEFAULT									
SETUP INDICATORS	SETUP INDICATORS	TOTAL DESCRIPTOR	VOLUME UNITS	TOTAL DEC PLACES	DENSITY DESC	DENSITY DEFAULT	RATE DEC PLACES	RATE DESCRIPTOR	RATE AVERAGE FILTER	QUICK UPDATE %	TEMP DESCRIPTOR				
SETUP FLOW INPUT	EXCITATION VOLTAGE	PULSE TRIGGER TYPE	LOW PASS FILTER	INPUT TERMINATION	MAX WINDOW	AUX FULL SCALE	AUX LOW SCALE	AUX HIGH ALARM	CHANGE TABLE A	CHANGE TABLE B	LOW FLOW RATE ALARM	HIGH FLOW RATE ALARM	METER EXPANSION	CALIBRATION TEMPERATURE	
SETUP AUX1 INPUT	AUX1 INPUT TYPE	AUX1 SIGNAL TYPE	CURRENT RANGE	AUX LOW SCALE	AUX FULL SCALE	OFFSET TEMPERATURE	AUX LOW ALARM	AUX HIGH ALARM	H2O DENSITY AT 4 °C						
SETUP AUX2 INPUT	AUX2 INPUT TYPE	AUX2 SIGNAL TYPE	VOLTAGE RANGE	CURRENT RANGE	AUX LOW SCALE	AUX FULL SCALE	AUX LOW ALARM	AUX HIGH ALARM							
SET FLUID PROPERTIES	FLUID NUMBER 0-9	FLUID NAME	REF. DENSITY	REF. TEMPERATURE	EXPANSION FACTOR	VISCOSITY COEF. A	VISCOSITY COEF. B								
SETUP PULSE OUTPUT	PULSE OUTPUT USAGE	PULSE WIDTH	PULSE VALUE												
SETUP ANALOG OUTPUT	ANALOG OUTPUT USAGE	ANALOG OUTPUT RANGE	ANALOG OUTPUT LOW SCALE	ANALOG OUTPUT FULL SCALE	ANALOG OUTPUT DAMPING										
SETUP RELAYS	SETUP RELAYS 1, 2, 3, 4	RELAY USAGE	ASSIGN AUX CHANNEL	RELAY DELAY	RELAY DURATION	RELAY MODE	RELAY SETPOINT	RELAY HYSTERESIS							
SETUP CONTROL INPUTS	SETUP CONTROL INPUTS 1, 2, 3	CONTROL INPUT 1 USAGE	CONTROL INPUT 2 USAGE	CONTROL INPUT 3 USAGE											
SETUP REAL TIME CLOCK	SETUP REAL TIME CLOCK	CLOCK TYPE	SELECT CLOCK AM/PM	TIME OF DAY	ENTER DATE										
SERIAL USAGE	SERIAL HARDWARE	DEVICE ID	BAUD RATE	PARITY	HANDSHAKE	DEVICE LINE FEED	MODEM OPTIONS	MODEM INIT MASTER	MODEM AUTO ANSWER	CALL OUT DAY OF WEEK	CALL OUT TIME	CALL ON ERROR/ALARM	CALL OUT NO	NUMBER OF REDIALS	HANGUP IF 2MIN. INACTIVE
SETUP DATALOG/PRINT	SETUP DATALOG/PRINT	OUTPUT FORMAT	PAGE LENGTH	TOP MARGIN	DATALOG ONLY	PRINT TIME	PRINT INTERVAL	ENABLE PRINT KEY	CLEAR TOTAL IF PRINT	PRINT LIST ITEMS					
ADMINISTRATIVE SETUP	TAG NUMBER	OPERATOR PASSWORD	SUPERVISOR PASSWORD	SOFTWARE VERSION	PRODUCT OR-DER CODE	UNIT SERIAL NUMBER	SENSOR SERIAL NUMBER	DISPLAY NEW ERROR ONLY							
SETUP NETWORK CARD	SELECT NETWORK PROTOCOL	NETWORK DEVICE ID	BAUD RATE	PARITY											

These functions will only appear with appropriate settings in other functions.

Appendix C - RS485 Modbus RTU Protocol

Introducing 923-ST1NET-FC with RS-485 & Modbus RTU Protocol

When the 923-ST1NET-FC is equipped with the RS-485 communication option, the protocol it uses is the Modbus RTU protocol. This protocol defines a message structure that hosts and clients will recognize and use on the RS-485 network over which they communicate. It describes the process a master device (PC compatible) uses to request access to another device (923-ST1NET-FC), how it will respond to requests from the other devices, and how errors will be detected and reported. It establishes a common format for the layout and contents of message fields.

During communications on a Modbus RTU network, the protocol determines how each 923-ST1NET-FC will know its device address, recognize a message addressed to it, determine the kind of action to be taken, and extract any data or other information contained in the message. If a reply is required, the 923-ST1NET-FC will construct the reply message and send it using Modbus RTU protocol.

RTU Mode

The 923-ST1NET-FC with RS-485 communications option supports the Modbus RTU (Remote Terminal Unit) mode only. The Modbus ASCII mode is not supported. The main advantage of the RTU mode is that its greater character density allows better data throughput than ASCII for the same baud rate. The Modbus RTU uses a Master-Slave Query-Response Cycle in which the 923-ST1NET-FC is the slave device.

Control Functions

The 923-ST1NET-FC with RS-485 communications option supports the following function codes:

CODE	NAME	DESCRIPTION
01	Read Coil Status	Read a single coil
03	Read Holding Register	Read a range of holding registers
05	Force Single Coil	Forces a single coil (0x reference) to either ON or OFF
06	Preset Single Register	Presets a value into a single holding register (4x reference)
15	Force Multiple Coil	Forces each coil (0x reference) in a sequence of coils to either ON or OFF
16	Preset Multiple Registers	Presets values into a sequence of holding registers (4x reference)

Appendix C - RS485 Modbus RTU Protocol

923-ST1NET-FC RS-485 Port Pinout (recommended mating connector: DB-9M)

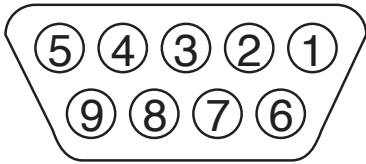

- 1 Ground
- 2 Ground
- 3 Ground
- 4 TX/RX (+)
- 5 TX/RX (-)
- 6 Do Not Use
- 7 Terminating Resistor (180 Ω)
- 8 TX/RX (+) (spare internally connected to 4)
- 9 TX/RX (-) (spare internally connected to 5)

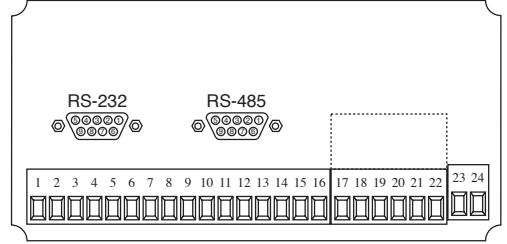

923-ST1NET-FC RS-485 Port Pinout (Terminal Block Option)

- 1 Common
- 2 TX/RX (+)
- 3 TX/RX (-)
- 4 Terminating Resistor (180Ω)

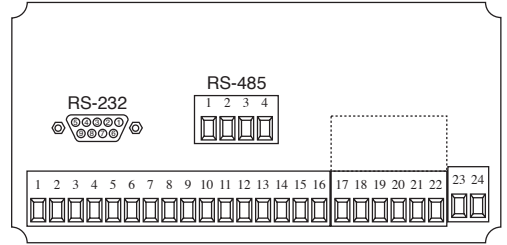

Installation Overview

A two wire RS-485 may be multidropped up to 4000 ft. and up to 32 units may be chained together. A RS-485 to RS-232 interface adaptor is required at the PC. An optically isolated type is recommended. Suitable wiring should be selected based on anticipated electrical interference. Terminators should be used to help improve the quality of electronic signals sent over the RS-485 wires. The RS-485 chain should be terminated at the beginning (RS-485 adaptor) and at the last device in the RS-485 chain and nowhere else. On the 923-ST1NET-FC this is accomplished by connecting a jumper from terminal 7 to terminal 4 or 8 at the RS-485 port when DB-9 connector is used. Place jumper between terminals 2 and 4 when the terminal block option is used. If lightning protection is required, a suitable surge protector should be used.

For additional information, refer to the technical requirements of EIA-485, interface adaptor user manual and the communication software user manual

923-ST1NET-FC Communication Setup Menu

The setup menu allows Modbus RTU Protocol communications parameters of: Device ID, Baud Rate, and Parity to be selected to match the parameters of your RS-485 network. Each 923-ST1NET-FC must have it's own Device ID and the same Baud Rate and Parity setting.

Appendix C - RS485 Modbus RTU Protocol

Register & Coil Usage

Register Usage (each register is 2 bytes)

923-ST1NET-FC Data	Register	Data Type	Access
Net Flow Rate *	Reg 40001 & 40002	Float	Read
Net Total *	Reg 40005 & 40006	Float	Read
Net Grand Total *	Reg 40007 & 40008	Float	Read
Temperature 1	Reg 40009 & 40010	Float	Read
Density 1	Reg 40011 & 40012	Float	Read
Preset 1	Reg 40013 & 40014	Float	Read/Write
Preset 2	Reg 40015 & 40016	Float	Read/Write
Preset 3	Reg 40017 & 40018	Float	Read/Write
Preset 4	Reg 40019 & 40020	Float	Read/Write
Year	Reg 40021	Integer	Read
Month	Reg 40022	Integer	Read
Day	Reg 40023	Integer	Read
Hours	Reg 40024	Integer	Read
Minutes	Reg 40025	Integer	Read
Seconds	Reg 40026	Integer	Read
Viscosity 1	Reg 40027 & 40028	Float	Read
Transaction Number	Reg 40029	Integer	Read
Unused	Reg 40030	—	—
Unused	Reg 40031 & 40032	—	—
Unused	Reg 40033 & 40034	—	—
Unused	Reg 40035 & 40036	—	—
Pulse Input 1 Frequency	Reg 40037 & 40038	Float	Read
Pulse Input 2 Frequency	Reg 40039 & 40040	Float	Read
KA Factor	Reg 40041 & 40042	Float	Read
KB Factor	Reg 40043 & 40044	Float	Read
Fluid Number	Reg 40045	Integer	Read/Write
Unused	Reg 40046	—	—
Temperature 2	Reg 40047 & 40048	Float	—
Density 2	Reg 40049 & 40050	Float	—
Viscosity 2	Reg 40051 & 40052	Float	—
Rate 1	Reg 40053 & 40054	Float	—
Rate 2	Reg 40055 & 40056	Float	—
Total 1	Reg 40057 & 40058	Float	—
Grand Total 1	Reg 40059 & 40060	Float	—
Total 2	Reg 40061 & 40062	Float	—
Grand Total 2	Reg 40063 & 40064	Float	—

* Parameters are active only when the instrument is configured for these calculations.

NOTE: The Float data type follows the IEEE format for a 32 bit float.

COIL USAGE (each coil is 1 bit)

923-ST1NET-FC Data	Coil	Data Type	Access
Error-Pulse Out Overflow	Coil 00001	bit	Read
Alarm-Flow Rate Alarm Low Volume Rate	Coil 00002	bit	Read
Alarm-Flow Rate Alarm High Volume Rate	Coil 00003	bit	Read
Alarm-Temp Alarm Low 1	Coil 00004	bit	Read
Alarm-Temp Alarm High 1	Coil 00005	bit	Read
Alarm-Temp Alarm Low 2	Coil 00008	—	—
Alarm-Temp Alarm High 2	Coil 00009	—	—
Unused	Coil 00010	—	—
Unused	Coil 00011	—	—
Unused	Coil 00012	—	—
	Coil 00013	—	—

Appendix C - RS485 Modbus RTU Protocol**Register & Coil Usage (continued)**

923-ST1NET-FC Data	Coil	Data Type	Access
Reserved	Coil 00014	bit	Read
Error-Software Error Reset	Coil 00015	bit	Read
Error-Extended PFI Lockup	Coil 00016	bit	Read
Unused	Coil 00017	–	–
Unused	Coil 00018	–	–
Error-Cal Checksum Error	Coil 00019	bit	Read
Error-Modem Not Found	Coil 00020	bit	Read
Error-Setup Checksum Error	Coil 00021	bit	Read
Error-Rate Overflow Error	Coil 00022	bit	Read
Error-A to D Not Converting	Coil 00023	bit	Read
Error-Aux Input Too Low	Coil 00024	bit	Read
Error-Aux Input Too High	Coil 00025	bit	Read
Error-Flow Input Too Low	Coil 00026	bit	Read
Error-Flow Input Too High	Coil 00027	bit	Read
Reserved	Coil 00028	bit	Read
Error-RTD Out Of Range	Coil 00029	bit	Read
Warning-Battery Low Warning	Coil 00030	bit	Read
Error-Time Clock Error	Coil 00031	bit	Read
Warning-Totalizer Rollover	Coil 00032	bit	Read
Command-Reset Total	Coil 00033	bit	Read/Write
Command-Reset Errors	Coil 00034	bit	Read/Write
Command-Print Command	Coil 00035	bit	Read/Write
Status-Instrument Type Rate/Total or Batch	Coil 00036	bit	Read
Reserved	Coil 00037	bit	Read/Write
Reserved	Coil 00038	bit	Read/Write
Reserved	Coil 00039	bit	Read/Write
Reserved	Coil 00040	bit	Read
Reserved	Coil 00041	bit	Read
Reserved	Coil 00042	bit	Read
Command-Relay 1 Command**	Coil 00043	bit	Read/Write
Command-Relay 2 Command**	Coil 00044	bit	Read/Write
Command-Relay 3 Command**	Coil 00045	bit	Read/Write
Command-Relay 4 Command**	Coil 00046	bit	Read/Write
Status-Relay 1 Status	Coil 00047	bit	Read
Status-Relay 2 Status	Coil 00048	bit	Read
Status-Relay 3 Status	Coil 00049	bit	Read
Status-Relay 4 Status	Coil 00050	bit	Read
Status-Control 1 Status	Coil 00051	bit	Read
Status-Control 2 Status	Coil 00052	bit	Read
Status-Control 3 Status	Coil 00053	bit	Read
Unused	Coil 00054	–	–
Unused	Coil 00055	–	–
Unused	Coil 00056	–	–
Unused	Coil 00057	–	–
Unused	Coil 00058	–	–
Unused	Coil 00059	–	–
Unused	Coil 00060	–	–
Unused	Coil 00061	–	–
Unused	Coil 00062	–	–
Unused	Coil 00063	–	–
Unused	Coil 00064	–	–

** Relay commands are only active if relays have been configured for “NA” (not assigned) in the setup menus.