



1.0 Hz to 100 kHz
Fixed Frequency

16 Pin DIP
4-Pole Filters

Description

The D74 and DP74 Series of low-power, fixed-frequency, linear active filters are high performance, 4-pole filters in a compact package. These Butterworth and Bessel low-pass and Butterworth high-pass filters (D74 only) combine linear active filter design with the space savings of a 16-pin dual in-line package (DIP). Each model comes factory tuned to a user-specified corner frequency between 1 Hz and 100 kHz (DP74, 1 Hz to 5kHz). These fully self-contained units require no external components or adjustments and operate with dynamic input voltage range from non-critical $\pm 5V$ to $\pm 18V$ power supplies.

Features/Benefits:

- Low cost solution for low frequency signal conditioning
- Compact DIP design minimizes board space requirements
- Plug-in ready-to-use, reducing engineering design and manufacturing time
- Factory tuned, no external clocks or adjustments needed saving time and labor of other discrete assembly solutions
- Low harmonic distortion and wide signal-to-noise ratio to 12 bit resolution

Applications

- Anti-alias filtering
- Vibration & shock analysis
- Automatic test equipment
- Aerospace, navigation and sonar
- Communication systems
- Medical electronics
- Sound and vibration testing
- Noise elimination
- Process control

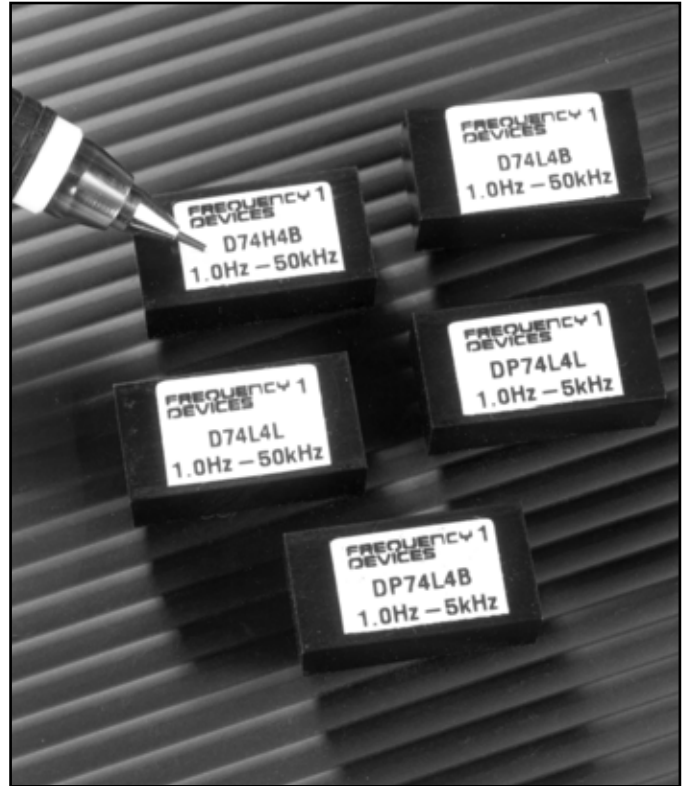

Available Low-Pass Models:

| | | | |
|----------------|--------------------------------|-------|----|
| D74L4B | 4-pole Butterworth | | .2 |
| DP74L4B | 4-pole Butterworth (Low Power) | | .2 |
| D74L4L | 4-pole Bessel | | .2 |
| DP74L4L | 4-pole Bessel (Low Power) | | .2 |

Available High-Pass Models:

| | | | |
|---------------|--------------------|-------|----|
| D74H4B | 4-pole Butterworth | | .2 |
|---------------|--------------------|-------|----|

General Specifications:

| | |
|---|-------|
| Pin-out/package data & ordering information | ... 3 |
|---|-------|



| Model | D74L4B & DP74L4B | D74L4L & DP74L4L | Model | D74H4B |
|---|--|---|---|--|
| Product Specifications | Low-Pass | Low-Pass | | High-Pass |
| Transfer Function | 4-Pole, Butterworth | 4-Pole, Bessel | Transfer Function | 4-Pole, Butterworth |
| Size | 0.88" x 0.46" x 0.375" | 0.88" x 0.46" x 0.375" | Size | 0.88" x 0.46" x 0.375" |
| Range f_c D74 DP74 | 1 Hz to 100 kHz 1 Hz to 5 kHz | 1 Hz to 100 kHz 1 Hz to 5 kHz | Range f_c | 1 Hz to 100 kHz |
| Theoretical Transfer Characteristics | Appendix A Page 7 | Appendix A Page 2 | Theoretical Transfer Characteristics | Appendix A Page 27 |
| Passband Ripple (theoretical) | 0.0 dB | 0.0 dB | Passband Ripple (theoretical) | 0.0 dB |
| DC Voltage Gain (non-inverting) | 0 ± 0.1 dB typ. | 0 ± 0.1 dB typ. | Voltage Gain (non-inverting) | 0 ± 0.1 dB to 100 kHz |
| Stopband Attenuation Rate | 24 dB/octave | 24 dB/octave | Stopband Attenuation Rate | 24 dB/octave |
| Power Bandwidth | | | Power Bandwidth | 120 kHz |
| Small Signal Bandwidth | | | Small Signal Bandwidth | (-6 dB) 1 MHz |
| Cutoff Frequency Stability Amplitude Phase | f_c ± 2% max. ± 0.03% /°C -3 dB -180° | f_c ± 2% max. ± 0.03% /°C -3 dB -121° | Cutoff Frequency Stability Amplitude Phase | f_c ± 2% max. ± 0.03% /°C -3 dB -180° |
| Filter Attenuation (theoretical) | 0.67 dB 0.80 f_c 3.01 dB 1.00 f_c 60.0 dB 5.62 f_c 80.0 dB 10.0 f_c | 1.86 dB 0.80 f_c 3.01 dB 1.00 f_c 60.0 dB 8.48 f_c 80.0 dB 15.12 f_c | Filter Attenuation (theoretical) | 80 dB 0.10 f_c 60 dB 0.18 f_c 3.01 dB 1.00 f_c 0.00 dB 4.00 f_c |
| Total Harmonic Distortion @ 1 kHz D74 DP74 | <-70 dB <-70 dB | <-70 dB <-70 dB | Total Harmonic Distortion @ 1 kHz D74 | <-70 dB |
| Wide Band Noise (5 Hz - 2 MHz) | 200 μ Vrms typ. | 200 μ Vrms typ. | Wide Band Noise (5 Hz - 2 MHz) | 400 μ Vrms typ. |
| Narrow Band Noise (20 Hz - 100 kHz) | 50 μ Vrms typ. | 50 μ Vrms typ. | Narrow Band Noise (20 Hz - 100 kHz) | 100 μ Vrms typ. |
| Filter Mounting Assembly | FMA-01A | FMA-01A | Filter Mounting Assembly | FMA-01A |



Specification

(25°C and Vs ±15 Vdc)

Pin-Out and Package Data Ordering Information

Analog Input Characteristics¹

| | |
|-------------------|------------|
| Impedance | 10 kΩ min. |
| Voltage Range | ± 10 Vpeak |
| Max. Safe Voltage | ±Vs |

Analog Output Characteristics

| | |
|------------------------------|-------|
| Impedance | 1 Ω |
| Linear Operating Range | ±10 V |
| Maximum Current ² | |

| | |
|------|--------|
| D74 | ±10 mA |
| DP74 | ±5 mA |

Offset Voltage

| | |
|----------------------------------|-------------------------------|
| f_c < 100 Hz | f_c ≥ 100 Hz |
| 0 – 50°C | 0 – 70°C |
| 10 mV max. | 10 mV max. |
| 3 mV typ. | 3 mV typ. |

Offset Temp. Coeff. 20 μV / °C

Power Supply (±V)

| | |
|------------------------------|---------------|
| Rated Voltage | ± 15 Vdc |
| Operating Range | ±5 to ±18 Vdc |
| Maximum Safe Voltage | ±18 Vdc |
| Quiescent Current D74 | |

| |
|-----------|
| 5 mA max. |
| 3 mA typ. |

Quiescent Current **DP74**

| |
|-------------|
| 1.5 mA max. |
| 600 μA typ. |

Temperature

| | |
|-----------|-----------------|
| Operating | 0 to + 70 °C |
| Storage | - 25 to + 85 °C |

Notes:

- Input and output signal voltage referenced to supply common.
- Output is short circuit protected to common. DO NOT CONNECT TO ±Vs.

All dimensions are in inches
All case dimensions ±0.01"
Grid Dimensions 0.1" x 0.1"

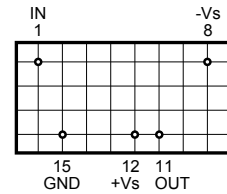

BOTTOM VIEW

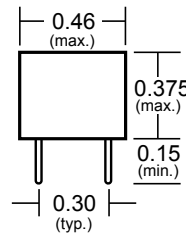

FRONT VIEW

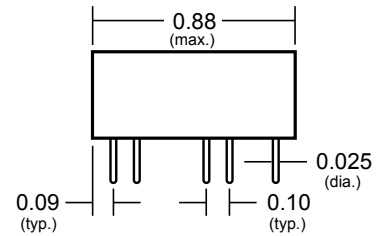

SIDE VIEW

Filter Mounting Assembly-See FMA-01A

Ordering Information

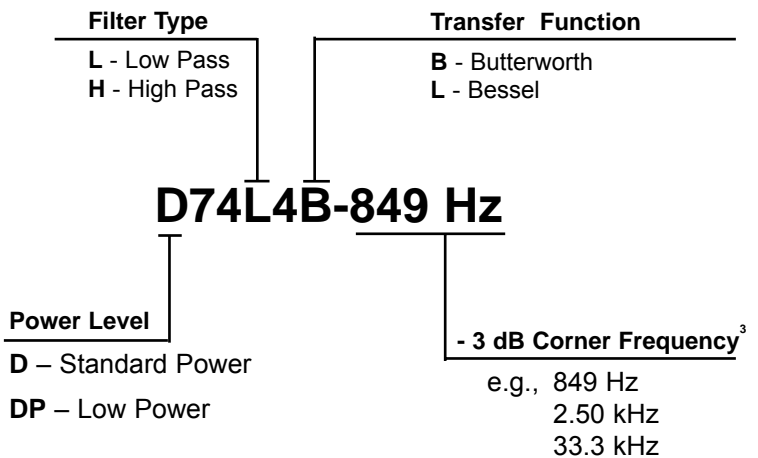

3. How to Specify Corner Frequency:

Corner frequencies are specified by attaching a three digit frequency designator to the basic model number. Corner frequencies can range from 1 Hz to 100 kHz.

We hope the information given here will be helpful. The information is based on data and our best knowledge, and we consider the information to be true and accurate. Please read all statements, recommendations or suggestions herein in conjunction with our conditions of sale which apply to all goods supplied by us. We assume no responsibility for the use of these statements, recommendations or suggestions, nor do we intend them as a recommendation for any use which would infringe any patent or copyright.



Appendix A

Theoretical Transfer Characteristics

| f/fc (Hz) | Amp (dB) | Phase (deg) | Delay ¹ (sec) |
|--------------|-------------|----------------|-----------------------------|
| 0.00 | 0.00 | 0.00 | .336 |
| 0.10 | -0.028 | -12.1 | .336 |
| 0.20 | -0.111 | -24.2 | .336 |
| 0.30 | -0.251 | -36.3 | .336 |
| 0.40 | -0.448 | -48.4 | .336 |
| 0.50 | -0.705 | -60.6 | .336 |
| 0.60 | -1.02 | -72.7 | .336 |
| 0.70 | -1.41 | -84.8 | .336 |
| 0.80 | -1.86 | -96.8 | .335 |
| 0.85 | -2.11 | -103 | .334 |
| 0.90 | -2.40 | -109 | .333 |
| 0.95 | -2.69 | -115 | .332 |
| 1.00 | -3.01 | -121 | .330 |
| 1.10 | -3.71 | -133 | .325 |
| 1.20 | -4.51 | -144 | .318 |
| 1.30 | -5.39 | -156 | .308 |
| 1.40 | -6.37 | -166 | .295 |
| 1.50 | -7.42 | -177 | .280 |
| 1.60 | -8.54 | -187 | .263 |
| 1.70 | -9.71 | -195 | .246 |
| 1.80 | -10.9 | -204 | .228 |
| 1.90 | -12.2 | -212 | .211 |
| 2.00 | -13.4 | -219 | .194 |
| 2.25 | -16.5 | -235 | .158 |
| 2.50 | -19.5 | -248 | .129 |
| 2.75 | -22.4 | -259 | .107 |
| 3.00 | -25.1 | -267 | .089 |
| 3.25 | -27.6 | -275 | .076 |
| 3.50 | -30.0 | -281 | .065 |
| 4.00 | -34.4 | -291 | .049 |
| 5.00 | -41.9 | -305 | .031 |
| 6.00 | -48.1 | -315 | .021 |
| 7.00 | -53.4 | -321 | .016 |
| 8.00 | -58.0 | -326 | .012 |
| 9.00 | -62.0 | -330 | .009 |
| 10.0 | -65.7 | -333 | .008 |

Frequency Response

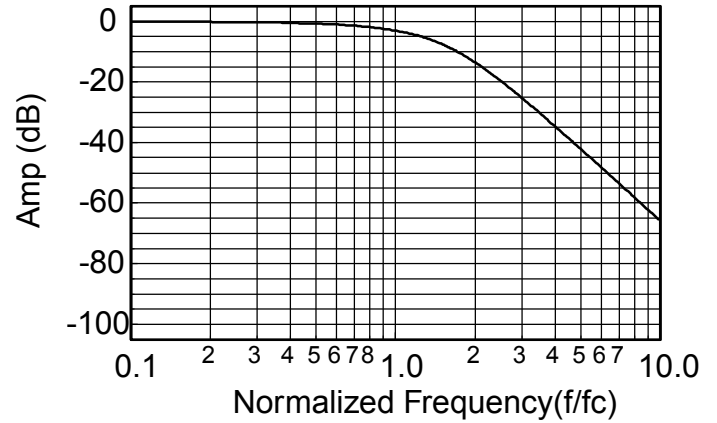

Delay (Normalized)

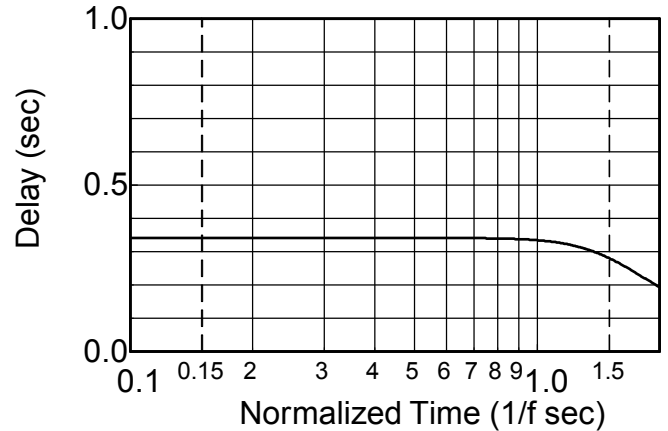

Step Response

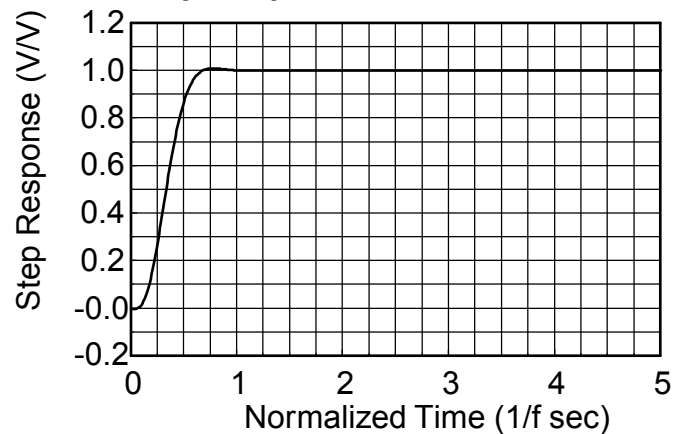

1. Normalized Group Delay:

The above delay data is normalized to a corner frequency of 1.0Hz. The actual delay is the normalized delay divided by the actual corner frequency (fc).

$$\text{Actual Delay} = \frac{\text{Normalized Delay}}{\text{Actual Corner Frequency (fc) in Hz}}$$



Appendix A

Theoretical Transfer Characteristics

| f/fc (Hz) | Amp (dB) | Phase (deg) | Delay ¹ (sec) |
|--------------|-------------|----------------|-----------------------------|
| 0.00 | 0.00 | 0.00 | .416 |
| 0.10 | 0.00 | -15.0 | .418 |
| 0.20 | 0.00 | -30.1 | .423 |
| 0.30 | -0.00 | -45.5 | .433 |
| 0.40 | -0.003 | -61.4 | .449 |
| 0.50 | -0.017 | -78.0 | .474 |
| 0.60 | -0.072 | -95.7 | .511 |
| 0.70 | -0.243 | -115 | .558 |
| 0.80 | -0.674 | -136 | .604 |
| 0.85 | -1.047 | -147 | .619 |
| 0.90 | -1.555 | -158 | .622 |
| 0.95 | -2.21 | -169 | .612 |
| 1.00 | -3.01 | -180 | .588 |
| 1.10 | -4.97 | -200 | .513 |
| 1.20 | -7.24 | -217 | .427 |
| 1.30 | -9.62 | -231 | .350 |
| 1.40 | -12.0 | -242 | .289 |
| 1.50 | -14.3 | -252 | .241 |
| 1.60 | -16.4 | -260 | .204 |
| 1.70 | -18.5 | -266 | .175 |
| 1.80 | -20.5 | -272 | .152 |
| 1.90 | -22.3 | -277 | .134 |
| 2.00 | -24.1 | -282 | .119 |
| 2.25 | -28.2 | -291 | .091 |
| 2.50 | -31.8 | -299 | .072 |
| 2.75 | -35.1 | -304 | .059 |
| 3.00 | -38.2 | -309 | .049 |
| 3.25 | -41.0 | -313 | .041 |
| 3.50 | -43.5 | -317 | .035 |
| 4.00 | -48.2 | -322 | .027 |
| 5.00 | -55.9 | -330 | .017 |
| 6.00 | -62.3 | -335 | .012 |
| 7.00 | -67.6 | -339 | .009 |
| 8.00 | -72.2 | -341 | .007 |
| 9.00 | -76.3 | -343 | .005 |
| 10.0 | -80.0 | -345 | .004 |

Frequency Response

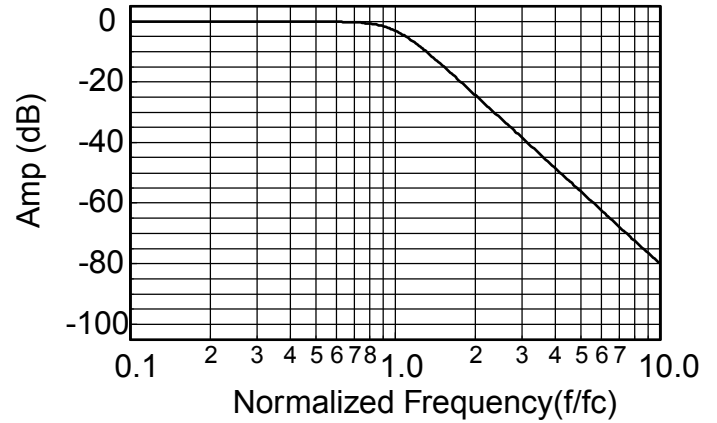

Delay (Normalized)

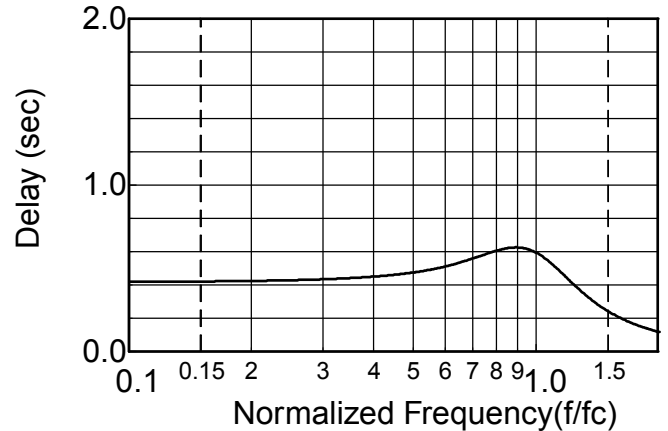

Step Response

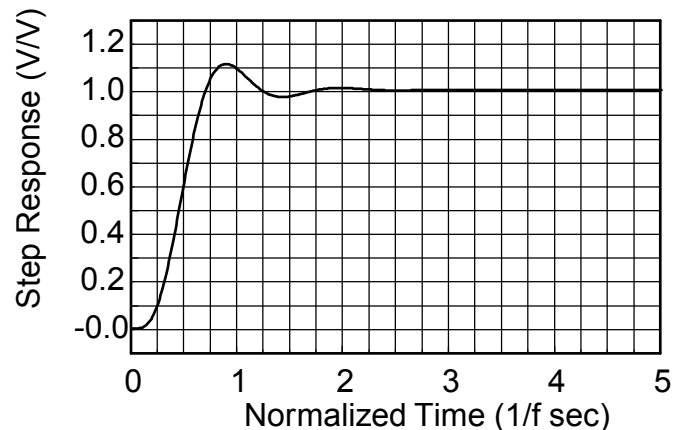

1. Normalized Group Delay:

The above delay data is normalized to a corner frequency of 1.0Hz. The actual delay is the normalized delay divided by the actual corner frequency (fc).

$$\text{Actual Delay} = \frac{\text{Normalized Delay}}{\text{Actual Corner Frequency (fc) in Hz}}$$



Theoretical Transfer Characteristics

| f/fc (Hz) | Amp (dB) | Phase (deg) | Delay ¹ (sec) |
|--------------|-------------|----------------|-----------------------------|
| 0.10 | -80.0 | 345 | .418 |
| 0.20 | -55.9 | 330 | .423 |
| 0.30 | -41.8 | 314 | .433 |
| 0.40 | -31.8 | 299 | .449 |
| 0.50 | -24.1 | 282 | .474 |
| 0.60 | -17.8 | 264 | .511 |
| 0.70 | -12.6 | 245 | .558 |
| 0.80 | -8.43 | 224 | .604 |
| 0.85 | -6.69 | 213 | .619 |
| 0.90 | -5.22 | 202 | .622 |
| 0.95 | -3.99 | 191 | .612 |
| 1.00 | -3.01 | 180 | .588 |
| 1.20 | -0.908 | 143 | .427 |
| 1.40 | -0.285 | 118 | .289 |
| 1.60 | -0.100 | 100 | .204 |
| 1.80 | -0.039 | 87.6 | .152 |
| 2.00 | -0.017 | 78.0 | .119 |
| 2.50 | -0.003 | 61.4 | .072 |
| 3.00 | -0.001 | 50.7 | .049 |
| 4.00 | 0.00 | 37.8 | .027 |
| 5.00 | 0.00 | 30.1 | .017 |
| 6.00 | 0.00 | 25.1 | .012 |
| 7.00 | 0.00 | 21.4 | .009 |
| 8.00 | 0.00 | 18.8 | .007 |
| 9.00 | 0.00 | 16.7 | .005 |
| 10.0 | 0.00 | 15.0 | .004 |

Frequency Response

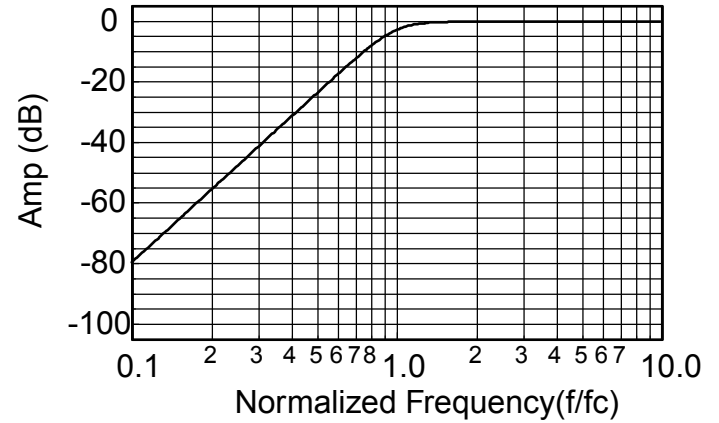

1. Normalized Group Delay:

The above delay data is normalized to a corner frequency of 1.0Hz. The actual delay is the normalized delay divided by the actual corner frequency (fc).

$$\text{Actual Delay} = \frac{\text{Normalized Delay}}{\text{Actual Corner Frequency (fc) in Hz}}$$