



D01-EVR Series

25 Hz to 1.00 MHz
Fixed Frequency

32-Pin DIP
8-Pole Filter

Description

The D01-EVR is a small, fixed-frequency, linear active DIP filter that provides high performance linear, multi-pole filtering in a compact package. These Butterworth and Bessel low-pass filters combine the excellent performance of linear multi-pole filter design with the space saving of the dual in-line package (DIP). Each filter comes factory tuned to a user-specified corner frequency between 25Hz and 1 MHz. These fully self-contained units require no external components or adjustments. They operate with dynamic input voltage range from non-critical $\pm 2.5V$ to $\pm 7.5V$ power supplies.

Features/Benefits:

- Low harmonic distortion and wide signal-to-noise ratio to 12 bit resolution
- Compact DIP design minimizes board space requirements
- Plug-in ready-to-use, reducing engineering design and manufacturing time
- Factory tuned, no external clocks or adjustments needed
- Broad range of pole configurations and corner frequencies to meet a wide range of applications

Applications

- Anti-alias filtering
- Data acquisition systems
- Video systems
- Communication systems and electronics
- Medical electronics equipment and research
- Aerospace, navigation and sonar applications
- Sound and vibration testing
- Real and compressed time data analysis
- Noise elimination
- Signal reconstruction

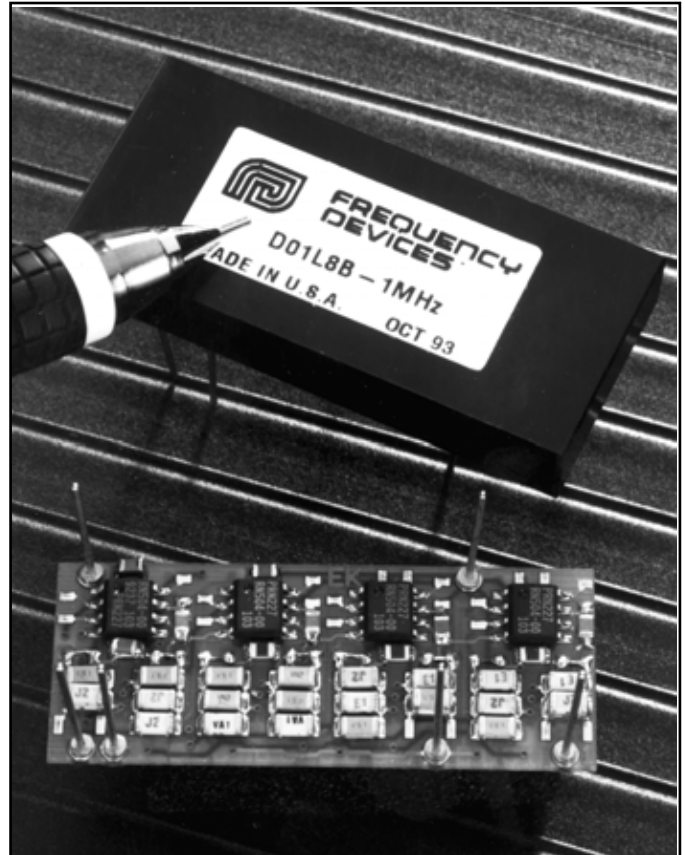

Available Low-Pass Models:

- D01L8B-EVR 8-pole Butterworth2
- D01L8L-EVR 8-pole Bessel2

General Specifications:

- Pin-out/package data & ordering information ...3



D01-EVR Series

8-Pole Low-Pass Filters

Fixed Frequency

Model	D01L8B-EVR	D01L8L-EVR		
Product Specifications				
Transfer Function	8-Pole, Butterworth	8-Pole, Bessel		
Size	1.80" x 0.80" x 0.30"	1.80" x 0.80" x 0.30"		
Range f_c	25 Hz to 1 MHz	25 Hz to 1 MHz		
Theoretical Transfer Characteristics	Appendix A Page 9	Appendix A Page 4		
Passband Ripple (theoretical)	0.0 dB	0.0 dB		
DC Voltage Gain (non-inverting)	0 ± 0.1 dB max. 0 ± 0.02 dB typ.	0 ± 0.1 dB max. 0 ± 0.02 dB typ.		
Stopband Attenuation Rate	48 dB/octave	48 dB/octave		
Cutoff Frequency Stability	f_c ± 5% max. ± 0.02%/° C	f_c ± 5% max. ± 0.02%/° C		
Amplitude Phase	-3 dB -360°	-3 dB -182°		
Filter Attenuation (theoretical)	0.12 dB 0.80 f_c 3.01 dB 1.00 f_c 60.0 dB 2.37 f_c 80.0 dB 3.16 f_c	1.91 dB 0.80 f_c 3.01 dB 1.00 f_c 60.0 dB 4.52 f_c 80.0 dB 6.07 f_c		
Phase Match ¹				
Amplitude Accuracy ¹				
Total Harmonic Distortion 2.5 V _{RMS}	1 kHz < -80 dB typ. 100 kHz < -65 dB typ.	1 kHz < -80 dB typ. 100 kHz < -65 dB typ.		
Wide Band Noise (20 Hz - 4 MHz)	250 µV _{RMS} typ.	250 µV _{RMS} typ.		
Narrow Band Noise (20 Hz - 100 kHz)	30 µV _{RMS} typ.	30 µV _{RMS} typ.		
Filter Mounting Assembly	NA	NA		

1. Phase Match and Amplitude Accuracy in the pass band are within ± 5% max. of the theoretical transfer characteristics.
NA - Not available



D01-EVR Series

Specification

(25°C and $V_s \pm 15$ Vdc)

Pin-Out and Package Data Ordering Information

Analog Input Characteristics ¹

Impedance	1 k Ω min.
Voltage Range	± 10 Vpeak
Max. Safe Voltage	$\pm V_s$

Analog Output Characteristics

Impedance (Closed Loop)	<1 Ω typ.
Linear Operating Range	± 10 V
Maximum Current ²	
$f_c > 50$ kHz	± 30 mA max.
$f_c < 50$ kHz	± 15 mA max.
Offset Voltage ³	± 10 mV max.
Offset Temp. Coeff.	50 mV/°C

Power Supply ($\pm V_s$)

Rated Voltage	± 15 Vdc
Operating Range	± 2.5 to ± 15 Vdc
Maximum Safe Voltage	± 15 Vdc
Quiescent Current	
8-Pole	± 30 mA max.

Temperature

Operating	0 to +70°C
Storage	-25 to +85°C

Notes:

- Input and output signal voltage referenced to supply common.
- Output is short circuit protected to common.
DO NOT CONNECT TO $\pm V_s$.
- Adjustable to zero.
- Units operate with or without of fset pin connected.

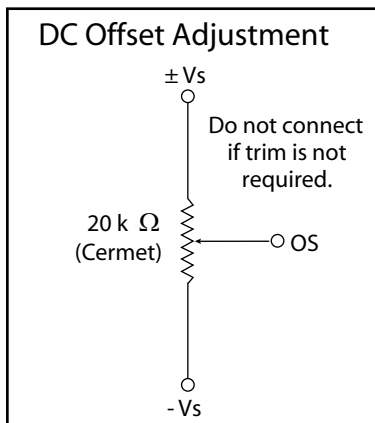

D01EVR package OUTLINE

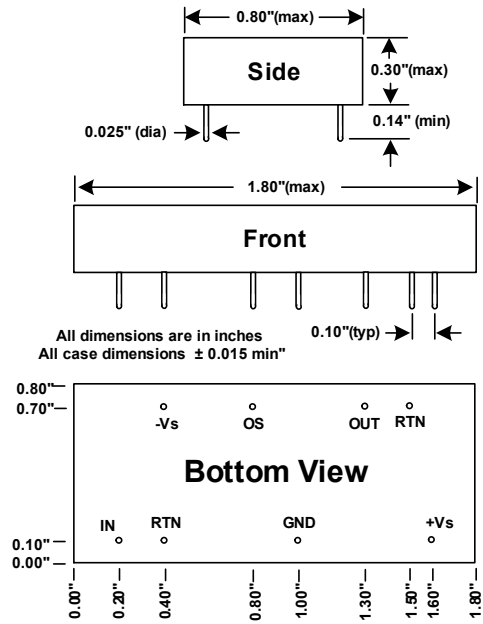

Ordering Information

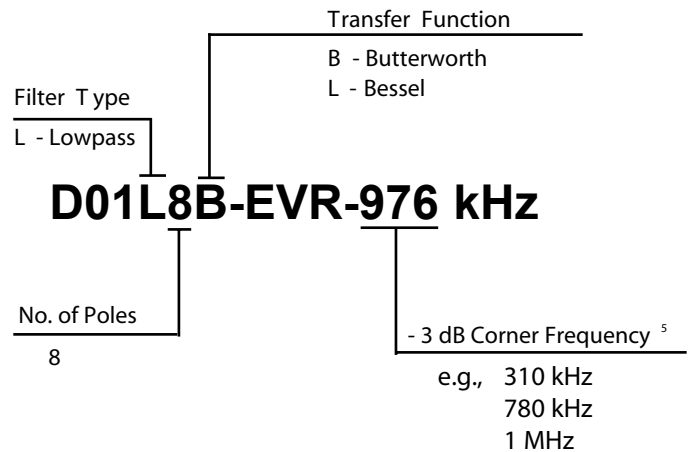

- How to Specify Corner Frequencies: Corner frequencies are specified by attaching a three digit frequency designator to the basic model number. Corner frequencies can range from 100Hz to 1 MHz.

We hope the information given here will be helpful. The information is based on data and our best knowledge, and we consider the information to be true and accurate. Please read all statements, recommendations or suggestions herein in conjunction with our conditions of sale which apply to all goods supplied by us. We assume no responsibility for the use of these statements, recommendations or suggestions, nor do we intend them as a recommendation for any use which would infringe any patent or copyright. PR-D01-EVR-02



Appendix A

Theoretical Transfer Characteristics

f/fc (Hz)	Amp (dB)	Phase (deg)	Delay ¹ (sec)
0.00	0.00	0.00	.506
0.10	-0.029	-18.2	.506
0.20	-0.117	-36.4	.506
0.30	-0.264	-54.7	.506
0.40	-0.470	-72.9	.506
0.50	-0.737	-91.1	.506
0.60	-1.06	-109	.506
0.70	-1.45	-128	.506
0.80	-1.91	-146	.506
0.85	-2.16	-155	.506
0.90	-2.42	-164	.506
0.95	-2.71	-173	.506
1.00	-3.01	-182	.506
1.10	-3.67	-200	.506
1.20	-4.40	-219	.506
1.30	-5.20	-237	.506
1.40	-6.10	-255	.505
1.50	-7.08	-273	.504
1.60	-8.16	-291	.502
1.70	-9.36	-309	.498
1.80	-10.7	-327	.492
1.90	-12.1	-345	.482
2.00	-13.7	-362	.468
2.25	-18.1	-402	.417
2.50	-23.1	-436	.352
2.75	-28.3	-465	.291
3.00	-33.4	-489	.241
3.25	-38.3	-509	.201
3.50	-43.1	-526	.170
4.00	-51.8	-552	.126
5.00	-66.8	-587	.077
6.00	-79.2	-610	.052
7.00	-89.8	-626	.038
8.00	-99.0	-638	.029
9.00	-107	-647	.023
10.0	-114	-655	.018

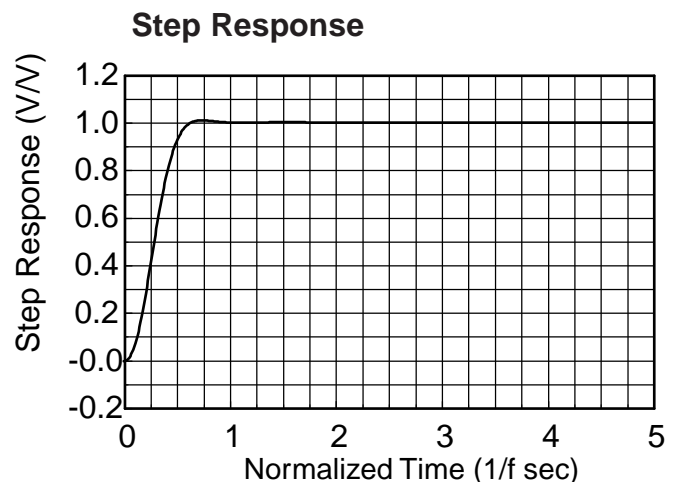
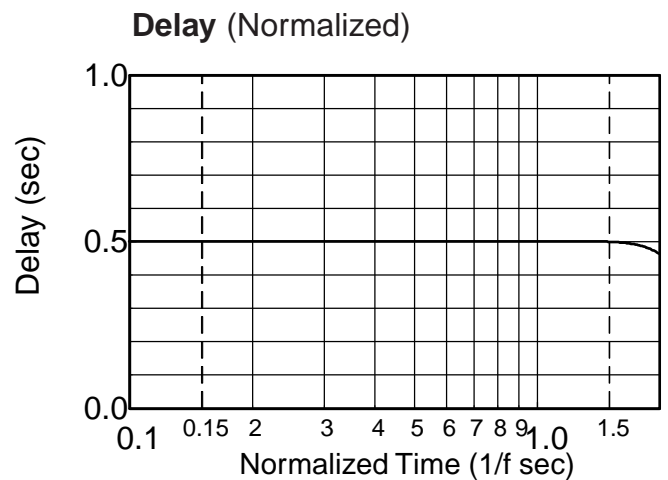
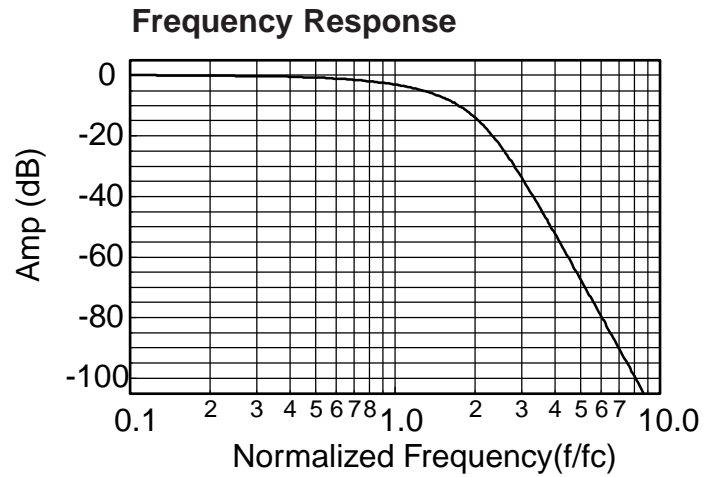

1. Normalized Group Delay:

The above delay data is normalized to a corner frequency of 1.0Hz. The actual delay is the normalized delay divided by the actual corner frequency (fc).

$$\text{Actual Delay} = \frac{\text{Normalized Delay}}{\text{Actual Corner Frequency (fc) in Hz}}$$



Appendix A

Theoretical Transfer Characteristics

f/fc (Hz)	Amp (dB)	Phase (deg)	Delay ¹ (sec)
0.00	0.00	0.00	.816
0.10	0.00	-29.4	.819
0.20	0.00	-59.0	.828
0.30	0.00	-89.1	.843
0.40	0.00	-120	.867
0.50	0.00	-152	.903
0.60	-0.001	-185	.956
0.70	-0.014	-221	1.04
0.80	-0.121	-261	1.19
0.85	-0.311	-283	1.29
0.90	-0.738	-307	1.40
0.95	-1.58	-333	1.48
1.00	-3.01	-360	1.46
1.10	-7.48	-408	1.17
1.20	-12.9	-445	.873
1.30	-18.2	-472	.672
1.40	-23.4	-494	.540
1.50	-28.2	-511	.448
1.60	-32.7	-526	.380
1.70	-36.9	-539	.328
1.80	-40.8	-550	.287
1.90	-44.6	-560	.253
2.00	-48.2	-568	.226
2.25	-56.3	-586	.174
2.50	-63.7	-600	.139
2.75	-70.3	-611	.113
3.00	-76.3	-621	.094
3.25	-81.9	-629	.080
3.50	-87.1	-635	.069
4.00	-96.3	-646	.052
5.00	-112	-661	.033
6.00	-125	-671	.023
7.00	-135	-678	.017
8.00	-144	-683	.013
9.00	-153	-687	.010
10.0	-160	-691	.008

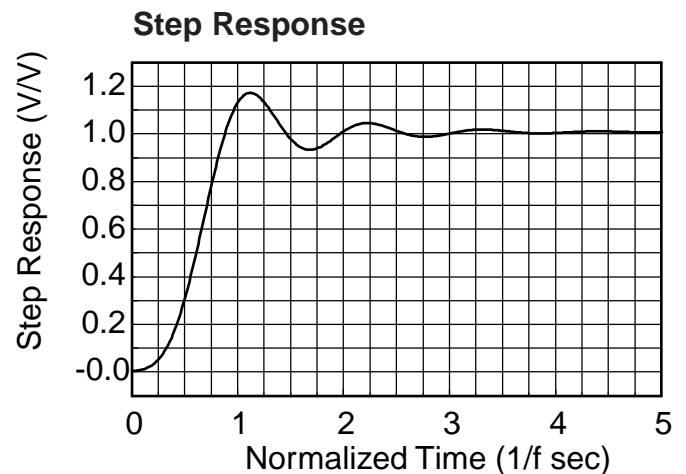
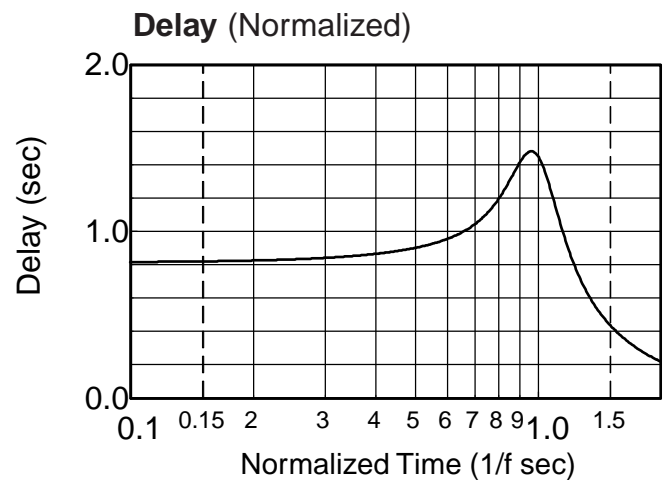
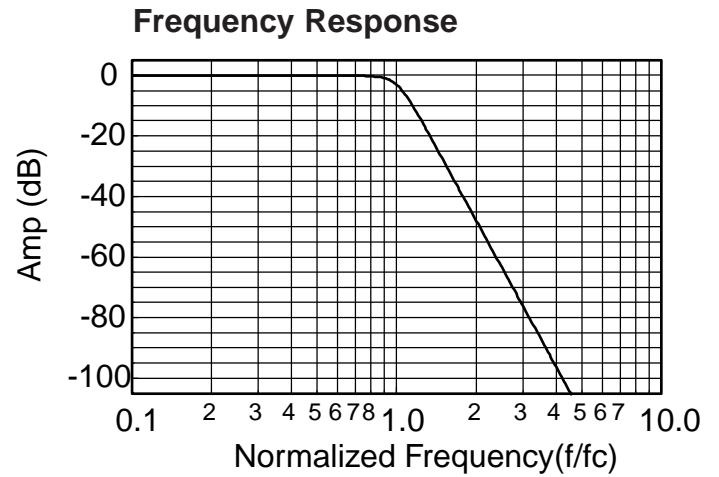

1. Normalized Group Delay:

The above delay data is normalized to a corner frequency of 1.0Hz. The actual delay is the normalized delay divided by the actual corner frequency (fc).

$$\text{Actual Delay} = \frac{\text{Normalized Delay}}{\text{Actual Corner Frequency (fc) in Hz}}$$