

**100 Hz to 100 kHz
Low Noise Fixed Frequency**

**4- and 8- Pole
Low-Pass Filters**

Description:

D100L Series filters are low noise and distortion 4- and 8-pole, Butterworth or Bessel fixed frequency low-pass filters. These filters feature near theoretical low noise and distortion performance, by providing up to -120 dB noise floors (20-Bit). D100L's take advantage of FDI's design expertise utilizing high performance amplifiers and surface-mount technology to provide design engineers with precision signal conditioning solutions in a compact package. These fully self-contained units require no external components or adjustments. Each D100L comes factory tuned to a user specified corner frequency between 100 Hz to 100 kHz and operate with low harmonic distortion over an input voltage range to ± 10 V.

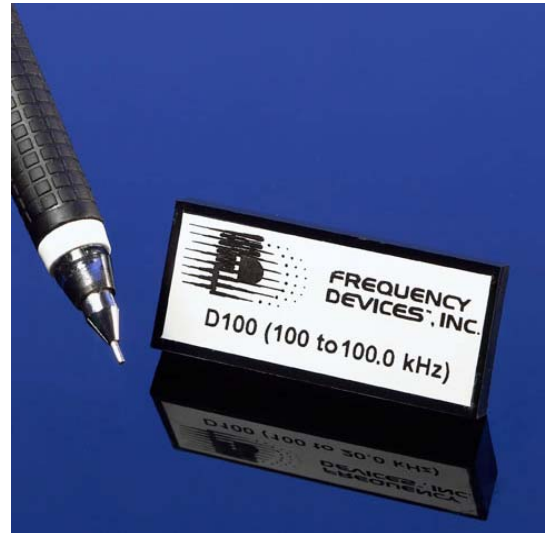

Features/Benefits:

- Small 32-pin DIP (1.8"L x 0.8"W) footprint minimizes board space requirements.
- Plug-in ready-to-use, reducing engineering design and manufacturing cycle time.
- Factory tuned, no external clocks or adjustments needed
- Broad range of corner frequencies to meet a wide range of applications.

Available Low-Pass Models:

		Page
D100L4L	4-Pole Bessel	2
D100L4B	4-Pole Butterworth	2
D100L8L	8-Pole Bessel	2
D100L8B	8-Pole Butterworth	2

General Specifications

Pin-out/package data & order information	3
--	---

Applications

- Transducer output filtering:
- Production test instrumentation
- Medical electronics equipment and research
- Noise and harmonic analysis
- Frequency spectrum analysis



100 Hz to 100 kHz
Low Noise Fixed Frequency

4- and 8- Pole
Low-Pass Filters

	D100L4B	D100L4L	D100L8B	D100L8L
Product Specifications				
Transfer Function	4-Pole Butterworth	4-Pole Bessel	8-Pole Butterworth	8-Pole Bessel
Size	1.8" x 0.8" x 0.3"	1.8" x 0.8" x 0.3"	1.8" x 0.8" x 0.3"	1.8" x 0.8" x 0.3"
Range f_c	100 Hz to 100 kHz	100 Hz to 100 kHz	100 Hz to 100 kHz	100 Hz to 100 kHz
Theoretical Transfer Characteristics	Appendix A Page 7	Appendix A Page 2	Appendix A Page 9	Appendix A Page 4
Passband Ripple (theoretical)	0.0 dB	0.0 dB	0.0 dB	0.0 dB
DC Voltage Gain (non-inverting)	0 ± 0.2 dB typ. 0 ± 0.4 dB max.	0 ± 0.2 dB typ. 0 ± 0.4 dB max.	0 ± 0.2 dB typ. 0 ± 0.4 dB max.	0 ± 0.2 dB typ. 0 ± 0.4 dB max.
Stopband Attenuation Rate	24 dB/octave	24 dB/octave	48 dB/octave	48 dB/octave
Cutoff Frequency Stability Amplitude Phase	f_c ± 1% max. ± 0.01%/°C -3 dB -180°	f_c ± 1% max. ± 0.01%/°C -3 dB -121°	f_c ± 1% max. ± 0.01%/°C -3 dB -360°	f_c ± 1% max. ± 0.01%/°C -3 dB -182°
Filter Attenuation (theoretical)	0.67 dB 0.80 f_c 3.01 dB 1.00 f_c 30.0 dB 2.37 f_c 40.0 dB 3.16 f_c	1.86 dB 0.80 f_c 3.01 dB 1.00 f_c 30.0 dB 3.50 f_c 40.0 dB 4.72 f_c	0.12 dB 0.80 f_c 3.01 dB 1.00 f_c 60.0 dB 2.37 f_c 80.0 dB 3.16 f_c	1.91 dB 0.80 f_c 3.01 dB 1.00 f_c 60.0 dB 4.52 f_c 80.0 dB 6.07 f_c
Phase Match¹	0 – f_c ± 2.0° max ± 1.0° typ	0 – f_c ± 2.0° max ± 1.0° typ	0 – f_c ± 2.0° max ± 1.0° typ	0 – f_c ± 2.0° max ± 1.0° typ
Amplitude Accuracy (theoretical)	0 – f_c ± 0.2 dB max ± 0.1 dB typ	0 – f_c ± 0.2 dB max ± 0.1 dB typ	0 – f_c ± 0.2 dB max ± 0.1 dB typ	0 – f_c ± 0.2 dB max ± 0.1 dB typ
(THD) Total Harmonic Distortion @ 10 Vp-p F_c ≤ 1.0 kHz F_c ≤ 20 kHz F_c ≤ 100 kHz	<-120 dB max. <-120 dB max. <-110 dB max.	<-120 dB max. <-120 dB max. <-110 dB max.	<-120 dB max. <-120 dB max. <-105 dB max.	<-120 dB max. <-120 dB max. <-105 dB max.
Narrow Band Noise 100 kHz BW @ 20V p-p	(μ V rms) F_c ≤ 1.0 kHz 7.0 typ., 12 max. F_c ≤ 20 kHz 7.0 typ., 12 max. F_c ≤ 100 kHz 22 typ., 40 max.	(μ V rms) 7.0 typ., 12 max. 7.0 typ., 12 max. 22 typ., 40 max.	(μ V rms) 12 typ., 22 max. 12 typ., 22 max. 40 typ., 70 max.	(μ V rms) 12 typ., 22 max. 12 typ., 22 max. 40 typ., 70 max.
Filter Mounting Assembly²	FMA-01S	FMA-01S	FMA-01S	FMA-01S

1. Unit to unit match for the same transfer function, set to the same frequency and operating configuration, and from the same manufacturing lot.
2. Use I/O jumpers to bypass input and output buffers, for low noise operation. With FMA, D100 distortion specs at 50k to 100kHz may degrade slightly.

Specifications
(25°C and $V_s \pm 15$ Vdc)

Pin-Out and Package Data
Ordering Information

Analog Input Characteristics¹

Impedance 1.0 k Ω min.
Voltage Range ± 10 V_{peak}
Max. Safe Voltage $\pm V_s$

Analog Output Characteristics

Load impedance 1k Ω min.
Linear Operating Range for THD ± 5 V
Operating Range for low Noise ± 10 V
Current² @ (V_s @ ± 15 V) 10 mA max.
Offset Voltage³ 2 mV typ.
20 mV max.
Offset Temp. Coefficient 50 μ V/°C.

Power Supply ($\pm V_s$)

Rated Voltage ± 15 V
Operating Range ± 5 V min.
 ± 18 V max.
Quiescent Current D100L4 40 mA max.
D100L8 80 mA max.

Temperature Range

Operating 0°C to +70°C
Storage -25°C to +85°C

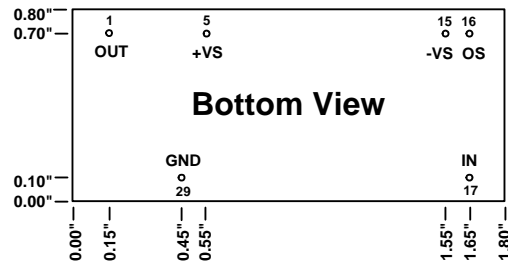
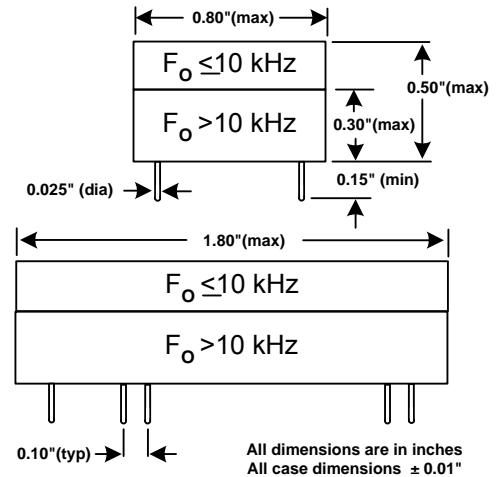

DC Offset Adjustment

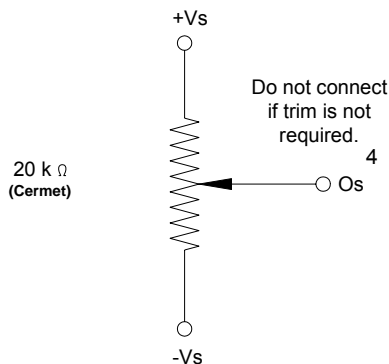

Notes:

1. Input and output signal voltage referenced to supply common.
2. Output is short circuit protected to common. DO NOT CONNECT TO $\pm V_s$.
3. Adjustable to zero.
4. Units operate with or without offset pin connected.
5. How to specify Corner Frequency. Corner frequency is specified by attaching a three-digit frequency designator to the basic model number. Corner frequencies can range from 100 Hz to 100 kHz.

ORDERING INFORMATION

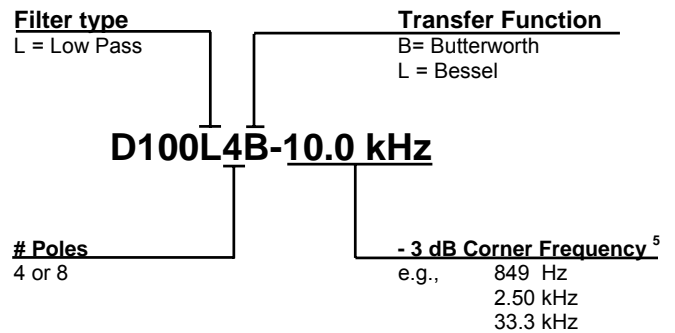

We hope the information given here will be helpful. The information is based on data and our best knowledge, and we consider the information to be true and accurate. Please read all statements, recommendations or suggestions herein in conjunction with our conditions of sale, which apply, to all goods supplied by us. We assume no responsibility for the use of these statements, recommendations or suggestions, nor do we intend them as a recommendation for any use, which would infringe any patent or copyright. PR-D100L



Appendix A

Theoretical Transfer Characteristics

f/fc (Hz)	Amp (dB)	Phase (deg)	Delay ¹ (sec)
0.00	0.00	0.00	.336
0.10	-0.028	-12.1	.336
0.20	-0.111	-24.2	.336
0.30	-0.251	-36.3	.336
0.40	-0.448	-48.4	.336
0.50	-0.705	-60.6	.336
0.60	-1.02	-72.7	.336
0.70	-1.41	-84.8	.336
0.80	-1.86	-96.8	.335
0.85	-2.11	-103	.334
0.90	-2.40	-109	.333
0.95	-2.69	-115	.332
1.00	-3.01	-121	.330
1.10	-3.71	-133	.325
1.20	-4.51	-144	.318
1.30	-5.39	-156	.308
1.40	-6.37	-166	.295
1.50	-7.42	-177	.280
1.60	-8.54	-187	.263
1.70	-9.71	-195	.246
1.80	-10.9	-204	.228
1.90	-12.2	-212	.211
2.00	-13.4	-219	.194
2.25	-16.5	-235	.158
2.50	-19.5	-248	.129
2.75	-22.4	-259	.107
3.00	-25.1	-267	.089
3.25	-27.6	-275	.076
3.50	-30.0	-281	.065
4.00	-34.4	-291	.049
5.00	-41.9	-305	.031
6.00	-48.1	-315	.021
7.00	-53.4	-321	.016
8.00	-58.0	-326	.012
9.00	-62.0	-330	.009
10.0	-65.7	-333	.008

Frequency Response

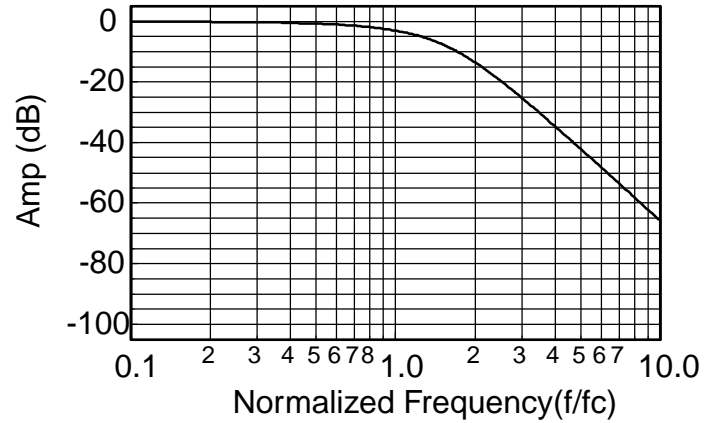

Delay (Normalized)

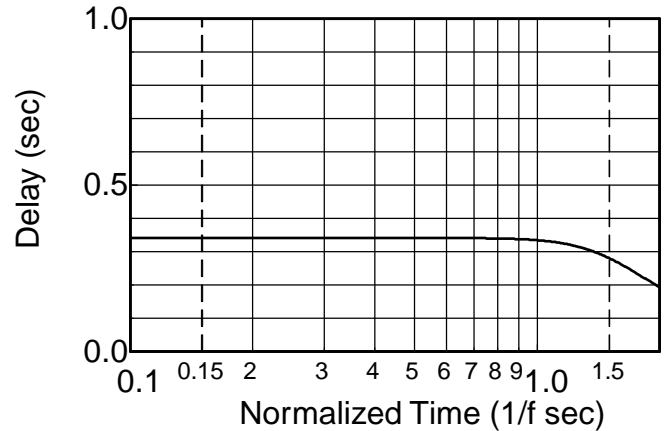

Step Response

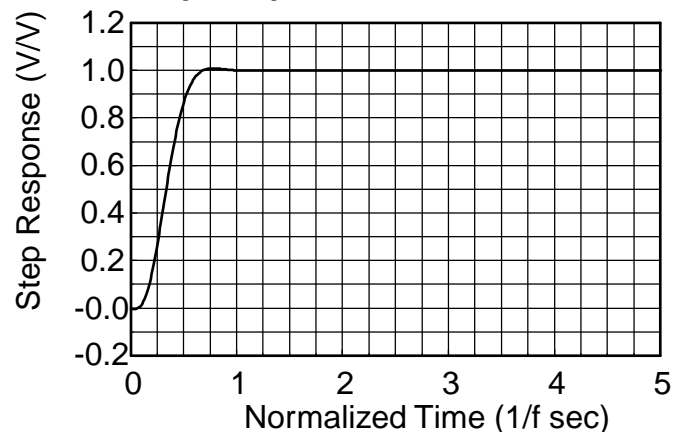

1. Normalized Group Delay:

The above delay data is normalized to a corner frequency of 1.0Hz. The actual delay is the normalized delay divided by the actual corner frequency (fc).

$$\text{Actual Delay} = \frac{\text{Normalized Delay}}{\text{Actual Corner Frequency (fc) in Hz}}$$



Appendix A

Theoretical Transfer Characteristics

f/fc (Hz)	Amp (dB)	Phase (deg)	Delay ¹ (sec)
0.00	0.00	0.00	.506
0.10	-0.029	-18.2	.506
0.20	-0.117	-36.4	.506
0.30	-0.264	-54.7	.506
0.40	-0.470	-72.9	.506
0.50	-0.737	-91.1	.506
0.60	-1.06	-109	.506
0.70	-1.45	-128	.506
0.80	-1.91	-146	.506
0.85	-2.16	-155	.506
0.90	-2.42	-164	.506
0.95	-2.71	-173	.506
1.00	-3.01	-182	.506
1.10	-3.67	-200	.506
1.20	-4.40	-219	.506
1.30	-5.20	-237	.506
1.40	-6.10	-255	.505
1.50	-7.08	-273	.504
1.60	-8.16	-291	.502
1.70	-9.36	-309	.498
1.80	-10.7	-327	.492
1.90	-12.1	-345	.482
2.00	-13.7	-362	.468
2.25	-18.1	-402	.417
2.50	-23.1	-436	.352
2.75	-28.3	-465	.291
3.00	-33.4	-489	.241
3.25	-38.3	-509	.201
3.50	-43.1	-526	.170
4.00	-51.8	-552	.126
5.00	-66.8	-587	.077
6.00	-79.2	-610	.052
7.00	-89.8	-626	.038
8.00	-99.0	-638	.029
9.00	-107	-647	.023
10.0	-114	-655	.018

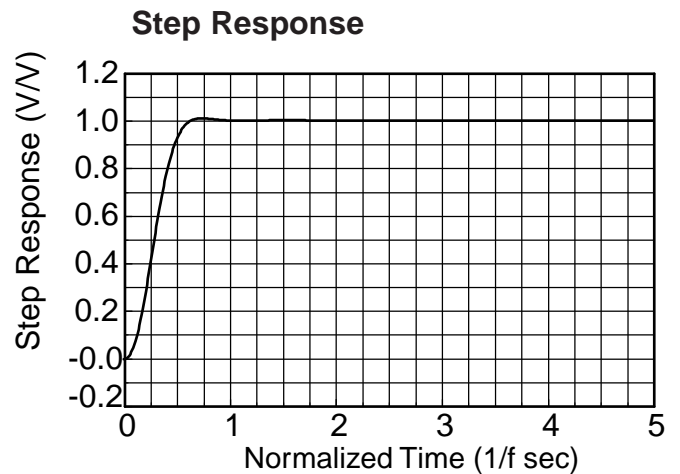
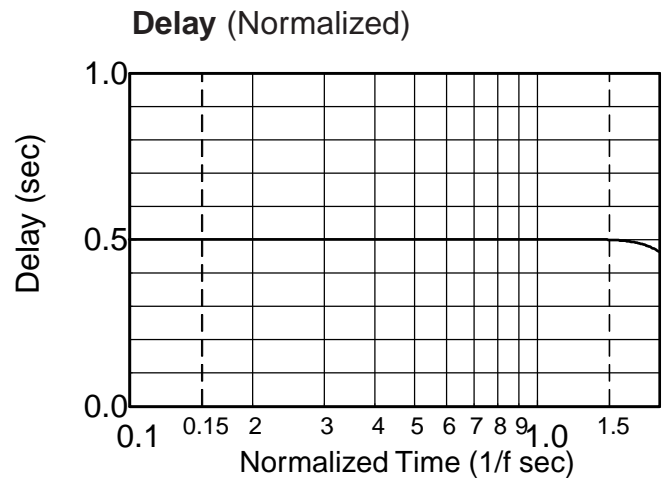
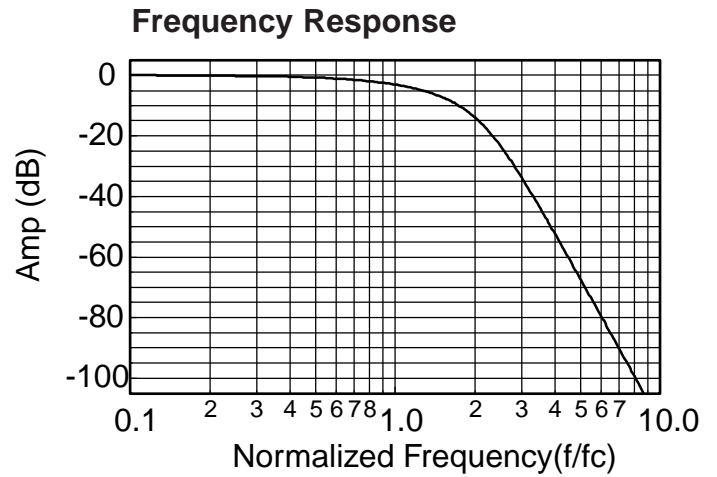

¹ **Normalized Group Delay:**
The above delay data is normalized to a corner frequency of 1.0Hz. The actual delay is the normalized delay divided by the actual corner frequency (fc).

$$\text{Actual Delay} = \frac{\text{Normalized Delay}}{\text{Actual Corner Frequency (fc) in Hz}}$$



Appendix A

Theoretical Transfer Characteristics

f/fc (Hz)	Amp (dB)	Phase (deg)	Delay ¹ (sec)
0.00	0.00	0.00	.416
0.10	0.00	-15.0	.418
0.20	0.00	-30.1	.423
0.30	-0.00	-45.5	.433
0.40	-0.003	-61.4	.449
0.50	-0.017	-78.0	.474
0.60	-0.072	-95.7	.511
0.70	-0.243	-115	.558
0.80	-0.674	-136	.604
0.85	-1.047	-147	.619
0.90	-1.555	-158	.622
0.95	-2.21	-169	.612
1.00	-3.01	-180	.588
1.10	-4.97	-200	.513
1.20	-7.24	-217	.427
1.30	-9.62	-231	.350
1.40	-12.0	-242	.289
1.50	-14.3	-252	.241
1.60	-16.4	-260	.204
1.70	-18.5	-266	.175
1.80	-20.5	-272	.152
1.90	-22.3	-277	.134
2.00	-24.1	-282	.119
2.25	-28.2	-291	.091
2.50	-31.8	-299	.072
2.75	-35.1	-304	.059
3.00	-38.2	-309	.049
3.25	-41.0	-313	.041
3.50	-43.5	-317	.035
4.00	-48.2	-322	.027
5.00	-55.9	-330	.017
6.00	-62.3	-335	.012
7.00	-67.6	-339	.009
8.00	-72.2	-341	.007
9.00	-76.3	-343	.005
10.0	-80.0	-345	.004

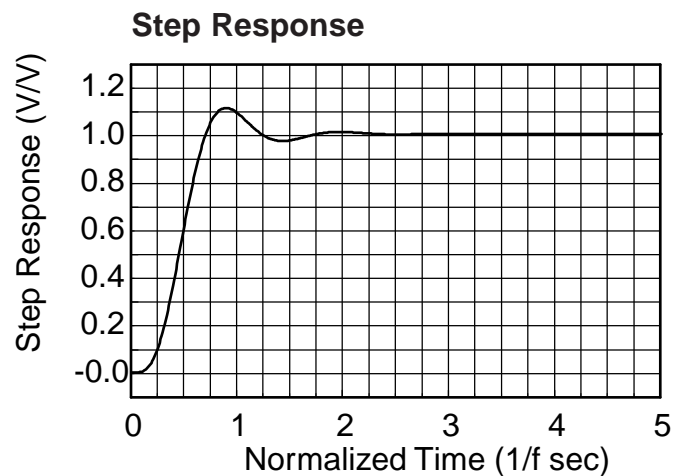
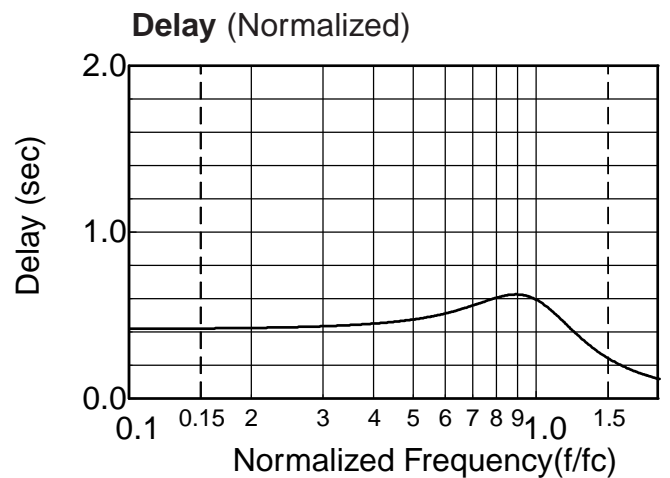
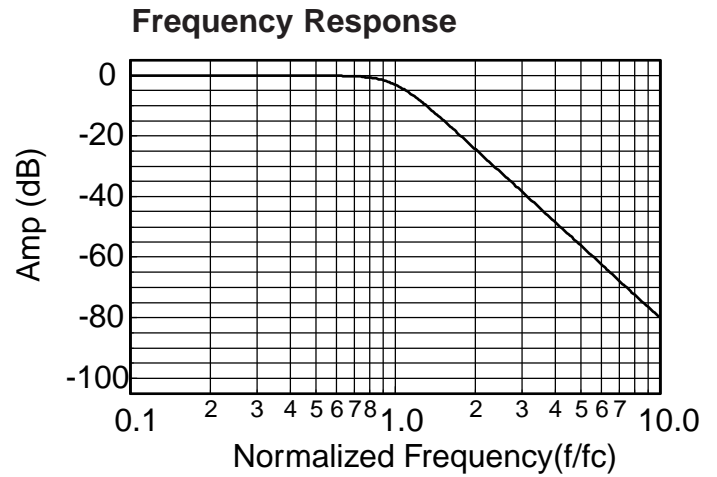

1. Normalized Group Delay:

The above delay data is normalized to a corner frequency of 1.0Hz. The actual delay is the normalized delay divided by the actual corner frequency (fc).

$$\text{Actual Delay} = \frac{\text{Normalized Delay}}{\text{Actual Corner Frequency (fc) in Hz}}$$



Appendix A

Theoretical Transfer Characteristics

f/fc (Hz)	Amp (dB)	Phase (deg)	Delay ¹ (sec)
0.00	0.00	0.00	.816
0.10	0.00	-29.4	.819
0.20	0.00	-59.0	.828
0.30	0.00	-89.1	.843
0.40	0.00	-120	.867
0.50	0.00	-152	.903
0.60	-0.001	-185	.956
0.70	-0.014	-221	1.04
0.80	-0.121	-261	1.19
0.85	-0.311	-283	1.29
0.90	-0.738	-307	1.40
0.95	-1.58	-333	1.48
1.00	-3.01	-360	1.46
1.10	-7.48	-408	1.17
1.20	-12.9	-445	.873
1.30	-18.2	-472	.672
1.40	-23.4	-494	.540
1.50	-28.2	-511	.448
1.60	-32.7	-526	.380
1.70	-36.9	-539	.328
1.80	-40.8	-550	.287
1.90	-44.6	-560	.253
2.00	-48.2	-568	.226
2.25	-56.3	-586	.174
2.50	-63.7	-600	.139
2.75	-70.3	-611	.113
3.00	-76.3	-621	.094
3.25	-81.9	-629	.080
3.50	-87.1	-635	.069
4.00	-96.3	-646	.052
5.00	-112	-661	.033
6.00	-125	-671	.023
7.00	-135	-678	.017
8.00	-144	-683	.013
9.00	-153	-687	.010
10.0	-160	-691	.008

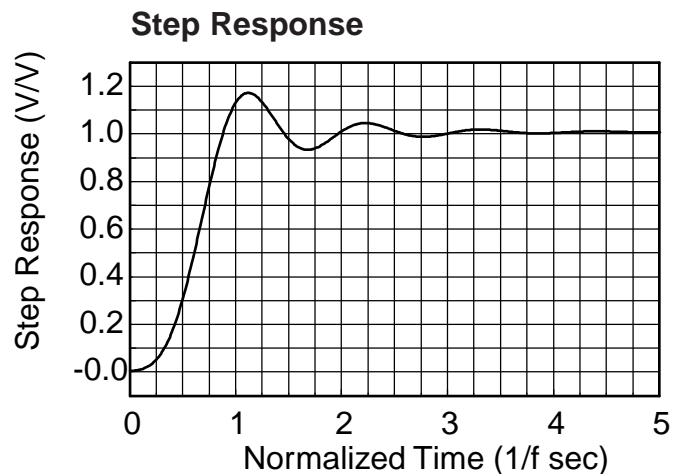
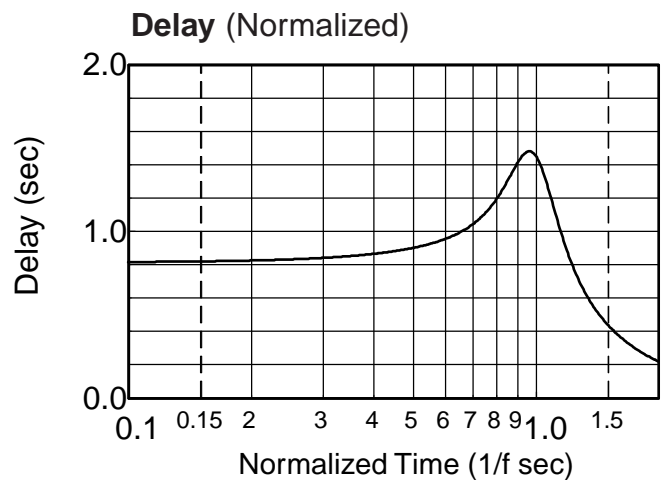
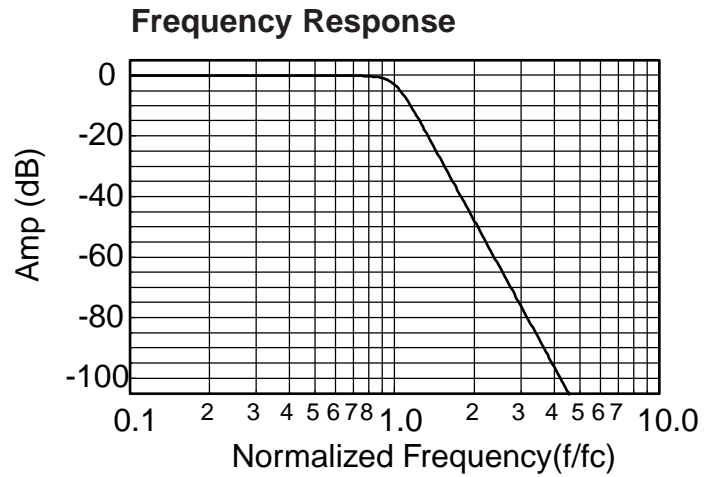

1. Normalized Group Delay:

The above delay data is normalized to a corner frequency of 1.0Hz. The actual delay is the normalized delay divided by the actual corner frequency (fc).

$$\text{Actual Delay} = \frac{\text{Normalized Delay}}{\text{Actual Corner Frequency (fc) in Hz}}$$